

Safety Information

- 1.Product ground wire should be connected to permanent fixed ground wire.
- 2.It is prohibited to use this product under the influence of alcohol or hypnotic.
- 3.It is not allowed for children to operate this product without the supervision of adult.
- 4.Special Notice: water temperature can not exceed 60 degrees centigrade.
- 5.Do not use strong corrosive detergent (such as vitriol, hydrochloric acid, lye) to disinfect or clean the body of steam shower house.
- 6.Please read through this manual before usage and operate according to this manual.
- 7.This product only be allowed to connect to power with GFCI/RCD (leakage circuit breaker) Refer to current breaker correct test and operation, leakage circuit breaker should be installed and tested by qualified electricians.
- 8.The diameter of ground wire shall be more than 1.5 square.
- 9.Caution: To prevent electric shock, the ground outlet must be connected to GFCI/RCD (leakage circuit breaker)
- 10.Caution: To prevent electric shock, do not use extended wire. And there must be well located supply power socket
- 11.Caution: To prevent being burnt by the steam, do not open the cover of the descale cleaning box during the motor is running.

Principle of the electric installation

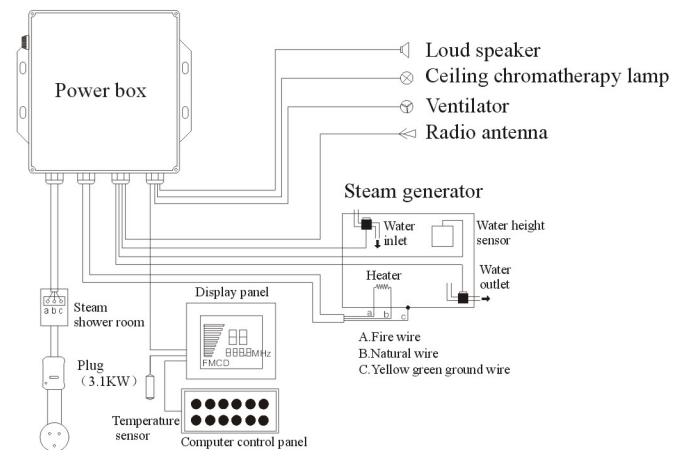

Equipments Reference

Parameter Components	Rated voltage	Rated voltage	Rated power
Pump	AC220-240V/50HZ	AC110-120V/60HZ	1125W
Steam generator	AC220-240V/50HZ	AC240V/60HZ	3000W
Chromatherapy lamp	DC12V	DC12V	10W
Ventilator	DC12V	DC12V	3W
Magnetic valve	DC12V	DC12V	5W
Computer control panel	AC220-240V/50HZ	AC240V/60HZ	
Loud speaker			10W
Remark			

CONTENTS

- 01-02 Component Introduction
- 03 Water and wire connection dimension
- 04-11 Installation Step
- 12-13 Control Panel Button and Function Demonstration for F3 Type Steam House
- 14 Steam House Removing Descale Cleaning Function
- 16 Troubleshooting

Component Introduction

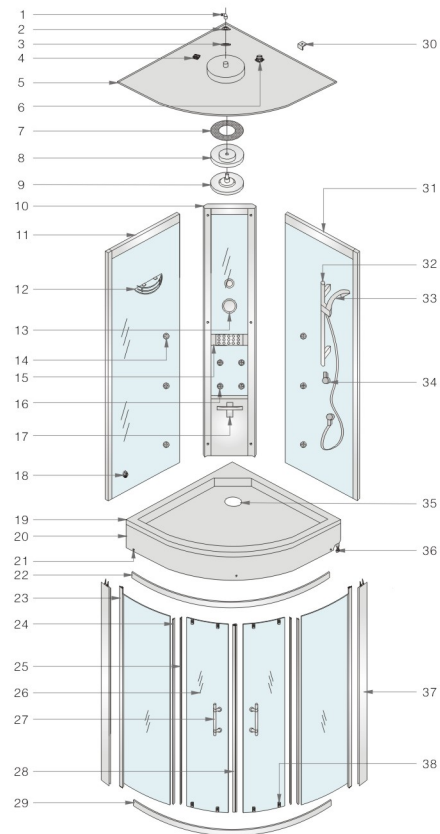











1.Copper jets(4 to 4)	2.1/2 Copper nut	3.4mm black rubber circle	4.90*90 Ventilator
			
5.Roof	6.4"water proof loudspeaker	7.Chromatherapy lamp	8.Acrylic lamp cover
			
9.2063#C shower head	10.Middle control panel	11.Left glass wall	12.Shampoo holder
			
13.Chrome plated faucet	14.Chrome plated jets (5 holes)	15.F3 control panel	16.Chrome plated jets (5 holes)
			
17.Folding plastic seat	18.Steam outlet	19.Shower tray	20.Shower tray skirt
			
21.White skirt screw	22.Upper track	23.Fixed door	24.F-shape water proof stripe
			

Component Introduction

25.L011B Water proof strip	26.Movable door	27.Handle
		
28.L008A(6MM)magnet strip	29.Lower track	30.Stainless steel roof fixer
		
31.Right glass wall	32.Slider bar	33.D222-1 shower
		
34.Descale cleaning box	35.Waste with trap	36.Adjustable feet
		
37.Corner aluminum frame	38.Elastic roller	
		

Spare parts bags:

Supporting iron bar (2pcs)	6x30 Hexangular allen screw(4 pcs)
	
4X10 Self-locking screws (27 pcs)	6mm Spring washer gasket (4 pcs)
	
Stainless steel roof fixer (7 pcs)	6mm Stainless steel washer (8 pcs)
	
Decoration cover for panel (6 pcs)	Screws sleeve (4 pcs)
	
3.5x30 Round self-locking screws (8 pcs)	6mm Stainless steel nuts (4 pcs)
	
4x25 Round self-locking screw (6 pcs)	
	

Water and wire connection dimension

DZ934F3 Specification: 900X900X2220mm

DZ932F3 Specification: 950X950X2220mm

DZ945F3 Specification: 1000X1000X2250mm

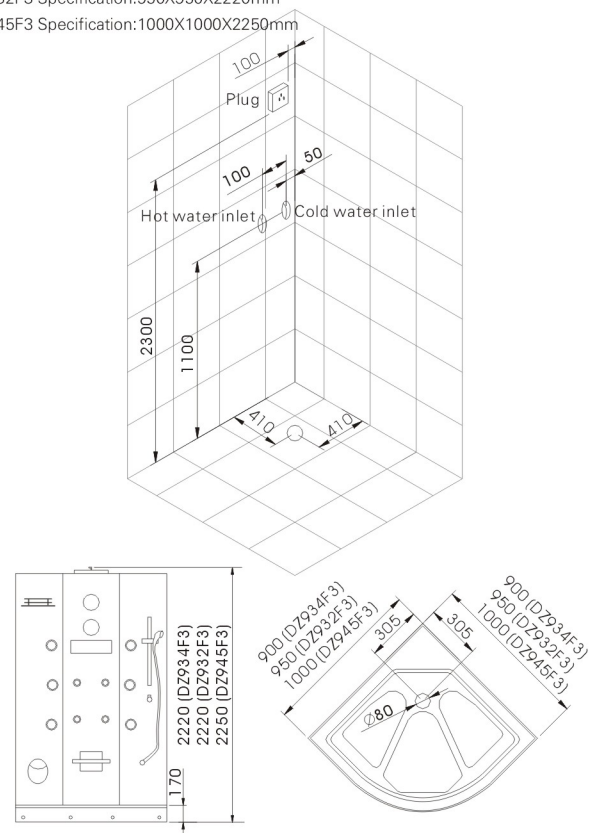

Installation Step 1

Move the shower tray to the suitable place, adjust the bottom of the screw, make it on the level.
 (Notice: adjust the height of the foot to make the bathtub on level. (As illustrated at drawing 1))

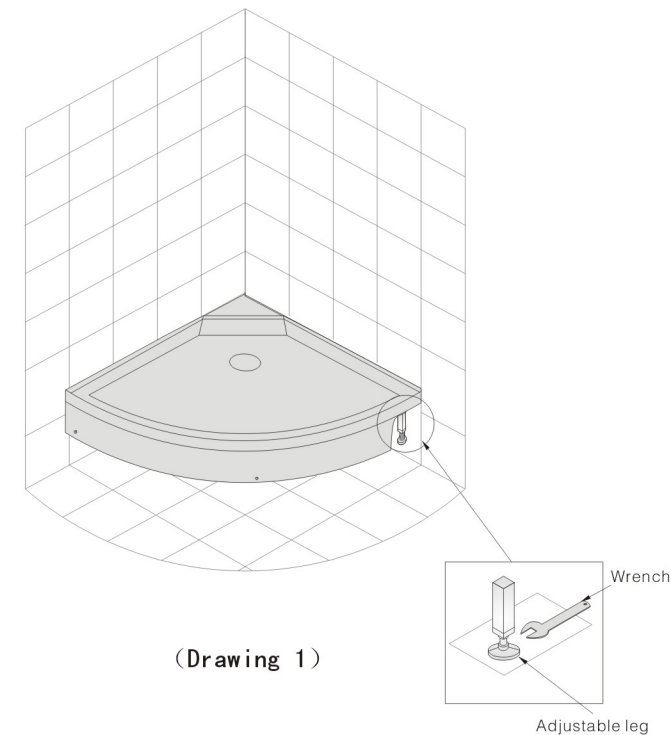

(Drawing 1)

Installation Step 2

1. Install the middle wall on the tray and connect left & right wall with it by 4 × 25 self-locking screws. (As illustrated at drawing A)
2. Cover the decoration cover for panel in the panelholes. (As illustrated at drawing B)

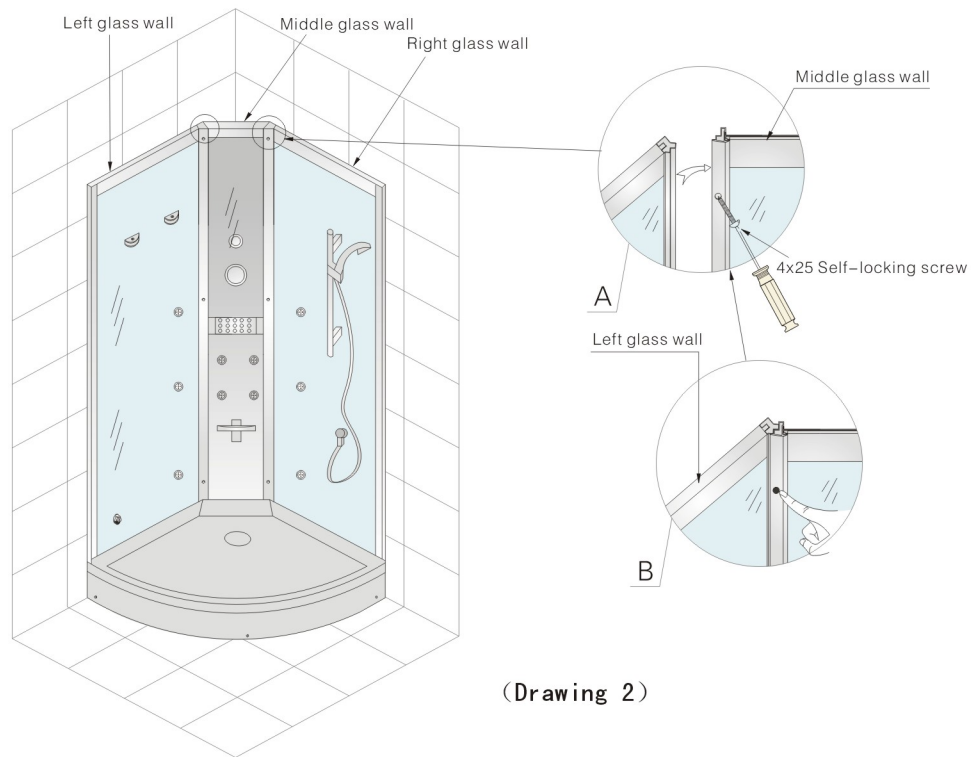

Installation Step 3

- Use 3.5X30 self-locking screws to connect left & right glass doors with upper & lower track. (As illustrated at drawing 3)

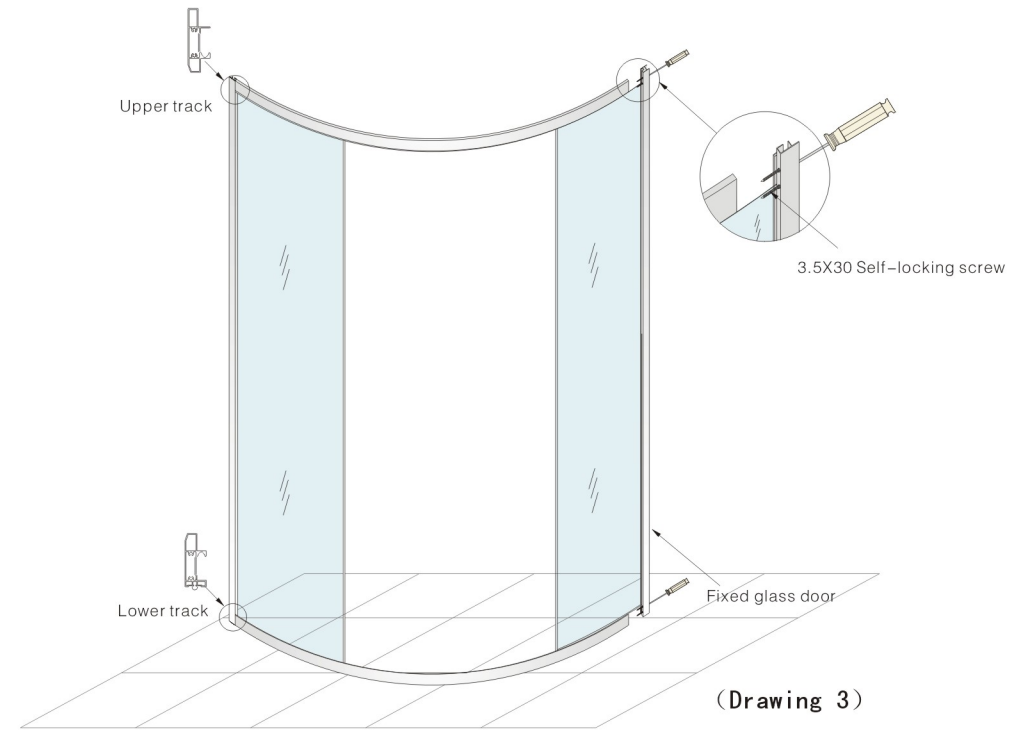

Installation Step 4

1. Put two corner aluminum profiles separately on the two sides of fixed glass door, fasten them with 4 x 10 self-locking screws. (As drawing A)
2. Install the whole set glass door on the shower tray and connect them with left & right glass walls by 4 x 10 self-locking screws. (As illustrated at drawing B) (As illustrated at drawing 4)

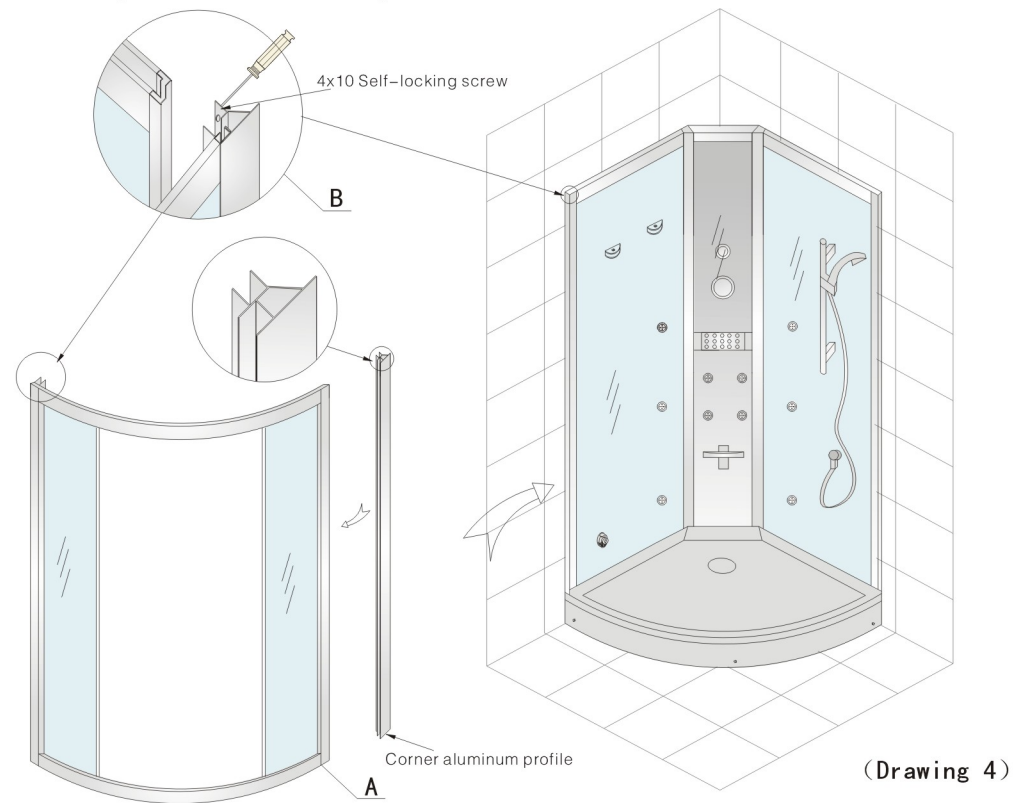

Installation Step 5

1. Sliding door installation: Hang the sliding door on the upper track (As illustrated at drawing A), and press the lower roller to hook the lower track (As illustrated at drawing B). Using a small slotted screwdriver to adjust in case the two sliding doors are not entirely closed.
2. Install fixed door water-proof strip C, install magnetic strip D and sliding door water-proof strip E on the two movable doors.
3. Install the handle on the sliding doors. (As illustrated at drawing F)

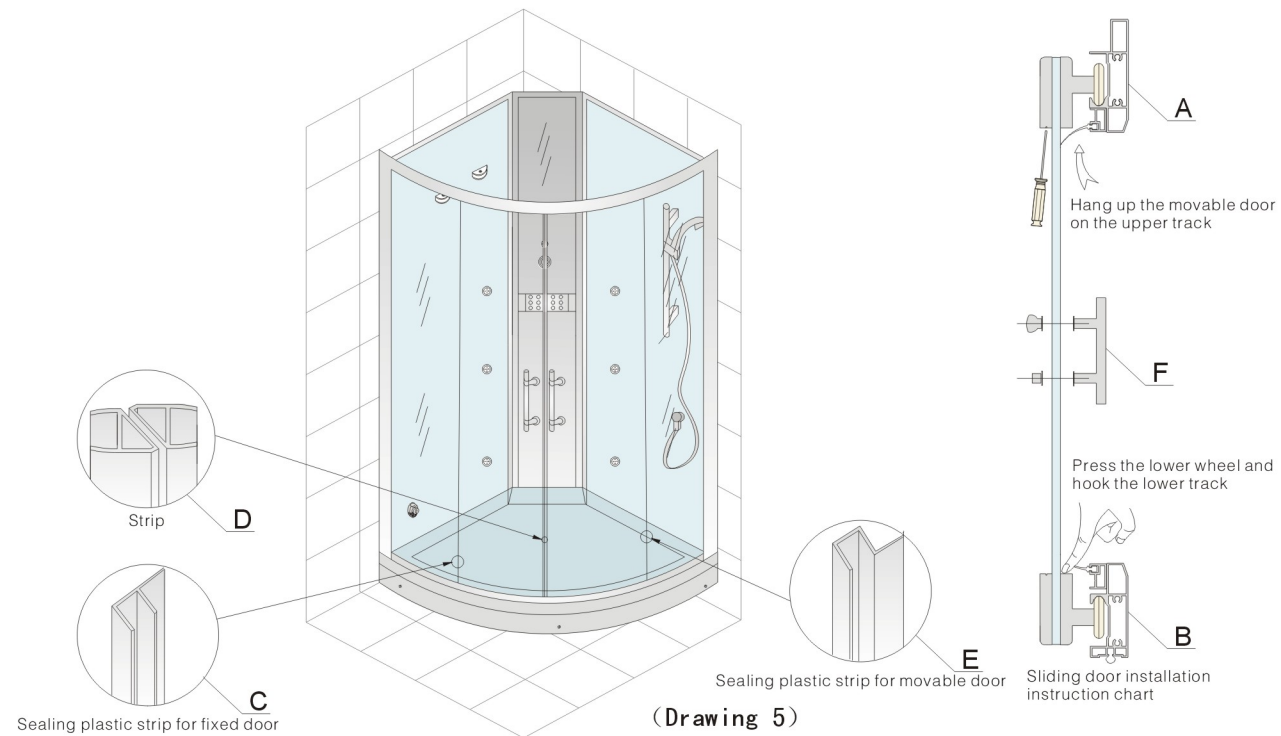

Installation Step 6

1. Put the roof on the top of the shower wall, and fix it with stainless steel clip and 4 x 10 self-locking screws. (As illustrated at drawing A)
2. Install the shampoo holder on the left side glass wall. (As illustrated at drawing B)
3. Install the on glass wall. (As illustrated at drawing C)
4. connect the hand shower hose with to the hand shower connector. (As illustrated at drawing D)

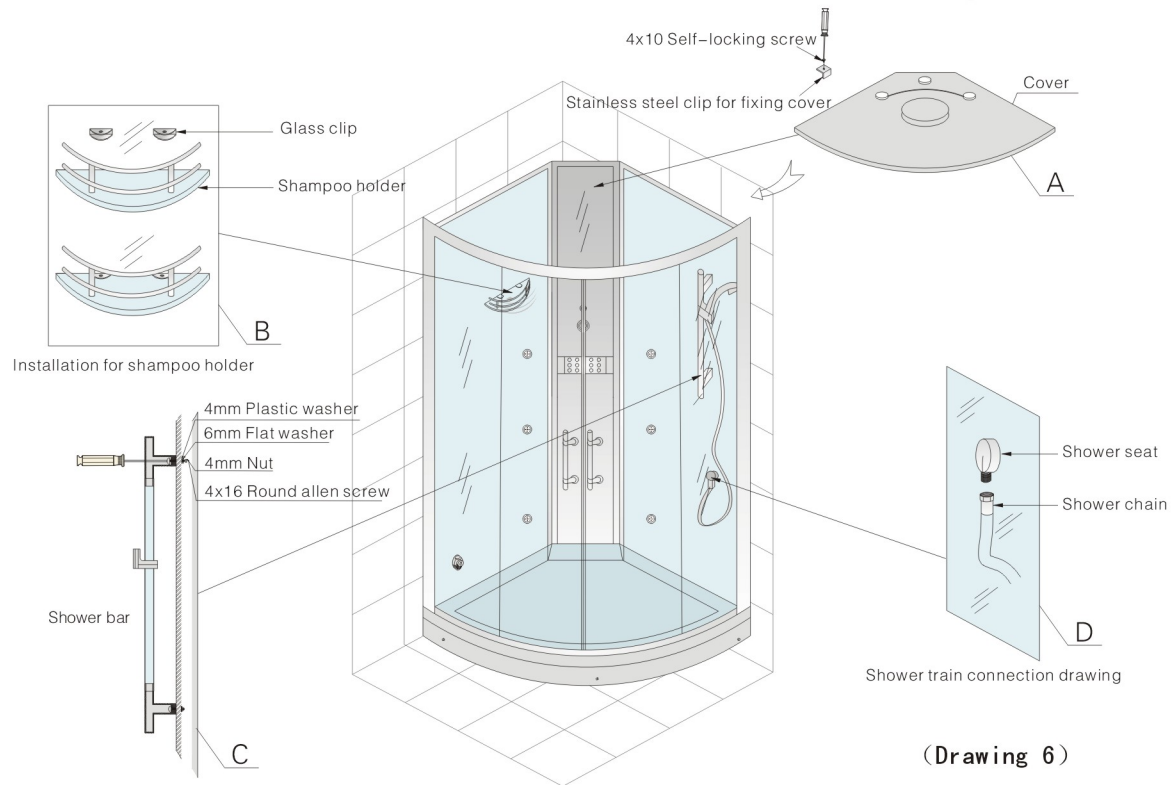

(Drawing 6)

Installation Step 7

1. Connect the glass wall and tray with 6 x 30 hexangular screws (As illustrated at drawing A)
2. Fasten the support iron bar on the panel by 4 x 10 self-locking screw (As illustrated at drawing B).
3. Connect the loudspeaker, ceiling lamp, ventilator in accordance with relevant lable plug. (As illustrated at drawing 7)

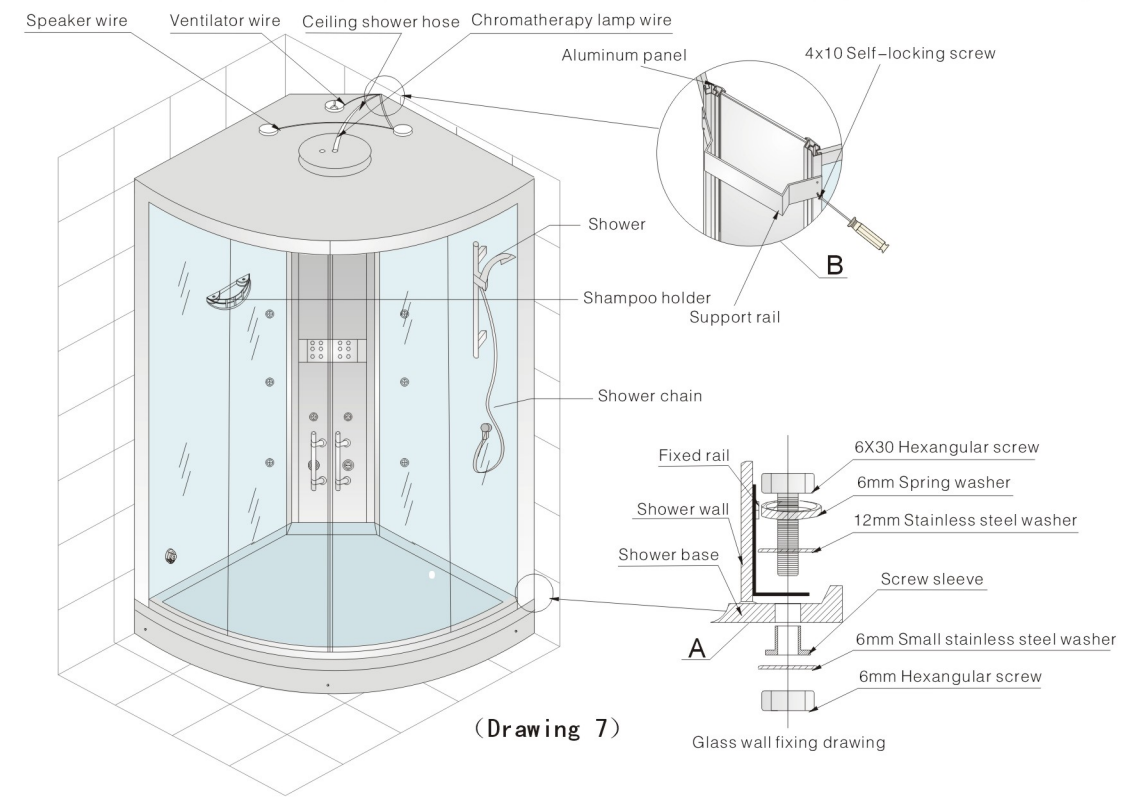

(Drawing 7)

Installation Step 8

Install ceiling shower hose, steam hose, steam outlet, cold and hot water hoses. Finally test whether the electric equipment and fittings work well. (As illustrated at drawing 8)

Note: The thermostatic faucet is optional

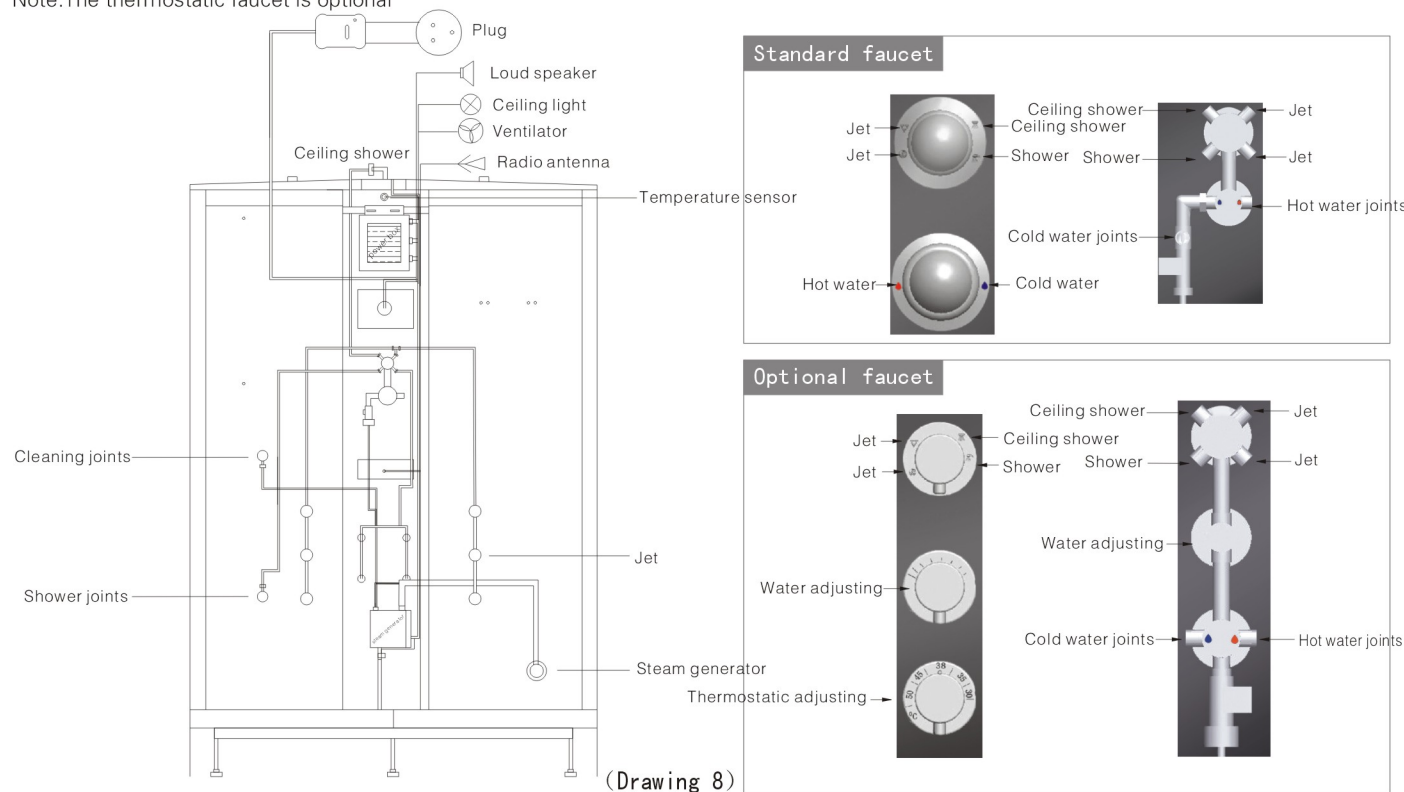

Control Panel Button and Function Demonstration for F3 Type Steam House

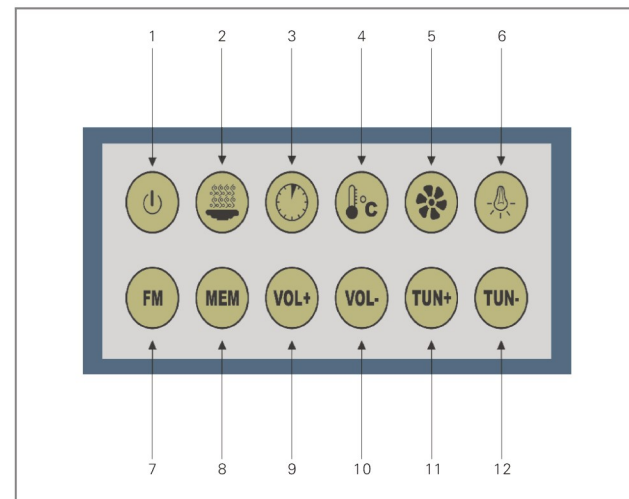

1、Power on/off

Turn on/off the system.

Press this key to open the control system. Press it once again to close the control system. It will be automatic shut down in one hour after it's been turn on. (As illustrated at drawingc 1)



Drawing 1

2、Steam

Press this key, the steam function will be opened, the screen will show. (As illustrated at drawing 2)



Drawing 2

3、Time setting

When the steam function is turned on, press this key will increase the setting of time. When press this key more than 1 second, the time setting will be increased until it reaches maximum limit (As illustrated at drawing 3), then it will turn to minimum limit automatically. The time setting range is between 5-50 minutes. The default time is 30 minutes.



Drawing 3

4、Temperature setting

When the steam function is turned on, press this key will increase the temperature. When press this key more than 1 second, the temperature will be increased until it reaches maximum limit, (As illustrated at drawing 4) then it will turn to minimum limit automatically.

The temperature range is between 20°C-50°C. The default time is 40 °C.



Drawing 4

Control Panel Button and Function Demonstration for F3 Type Steam House

5、Ventilator

Press this key the ventilator will turn on, and press it once again to turn off the ventilator.(As illustrated at drawing 5)



Drawing 5

6、Chromatherapy

Press this key to turn on the chromatherapy. When it is turned on, color be changed each time the button is pressed .

When press first time, the blue light on. When press the second time, the blue & red light on. When press third time, the red light on. When press the fourth time, the red & orange light on. When press fifth time, the orange light on. When press the sixth time, the orange & blue light on. When press seventh time, the chromatherapy will turn on cycling, when press the eighth time, the light will turn off.

Chromatherapy works in this sequence: turn on—blue—blue& red —red—red & orange —orange—orange & blue—circulating—turn off.



Drawing 6

7、Radio

Press this key to turn on and press it to turn off the radio function(As illustrated at drawing 7).



Drawing 7

8、Channel saving

Press this key and release within 1 second, the frequency of current location will be found . press this key and hold it more than 1 second, the frequency will be saved to current location. It can save 8 channels.



Drawing 8

9、Volume +

When the radio is turned on, press this key will increase the volume.



Drawing 9

10、Volume -

When the radio is turned on, press this key will decrease the volume.



Drawing 10

11、Frequency +

When the radio is turned on, press this key will Increase the frequency. If hold it more than 1 second, the frequency will be increased automatically until one channel has been found. The frequency range is between 87.5—108.0MHZ.

12、Frequency -

When the radio is turned on, press this key will decrease the frequency. If hold it more than 1 second, the frequency will be decreased automatically until one channel has been found. The frequency range is between 87.5—108.0MHZ.

Steam House Removing Descale Cleaning Function

Using steps: power off →open the descale cover→input cleaning solution→cover the descale cover→Power on、 run the automatic cleaning function→power off and water discharge

1、 Power off

For safety ,it is forbidden to twist the cover of detergent box so as to avoid being burnt by the steam. Before using the cleaning function, if it is in an open state, please close all of the function. press  key to power off.(As illustrated at drawing 1)

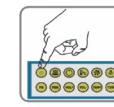

(Drawing 1)

2、 Open the descale cover

After confirming the system power off, press the right label and found the detergent box in the steam house. twist the cover by reverse direction and take out of the box cover .(As illustrated at drawing 2)

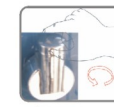

(Drawing 2)

3、 Input cleaning solution

Open the detergent box, use the spoon to pour the citric acid or compounds cleaning fluid into the box. (As illustrated at drawing 3)

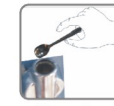

(Drawing 3)

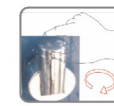

4、 cover the descale cover

After inputting the cleaning liquid, whirl the box cover in clock wise direction, twist the cover and avoid the steam hurting the people. (As illustrated at drawing 4)



(Drawing 4)

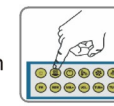

5、 Power on、 run the automatic cleaning function

After covering the detergent box, press  to power on. Then press  key to open the cleaning function and let and system to automatically cleaning.(As illustrated at drawing 5)



(Drawing 5)

6、 power off and water discharge

After 5 to 10 minutes, press  key to close the steam function, and press  to power off. The dirty water will be discharged automatically. The cleaning process will be finished after 5 minutes .(As illustrated at drawing 6)

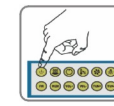

(Drawing 6)

Attention:

- 1.It is forbidden to use cleaning function when using other function.
- 2.It is forbidden to use the alkaline compounds to clean the steam generator ;
- 3.It is forbidden to use the solid cleaning agent to clean the steam generator, so as to avoid plugging the pipes.

We recommend that you use citric acid solution to clean the steam generator!

Troubleshooting

Malfunctions	Causes	Solutions	Malfunctions	Causes	Solutions
Chromatherapy light doesn't work	<ol style="list-style-type: none"> 1.Plug is off. 2.Control circuit board is burnt. 	<ol style="list-style-type: none"> 1.Re-plug in the plug or replace plug. 2.Contact with dealer or the manufacture after-sale department. 	Steam key signal on, but no steam comes out	<ol style="list-style-type: none"> 1.Temperature limiter works or heater is burnt. 	<ol style="list-style-type: none"> 1.Ask professional people to repair.
Slow water outlet	<ol style="list-style-type: none"> 1.Supply water pressure is low. 2.Water inlet block. 	<ol style="list-style-type: none"> 1.Check supply water pressure. 2.Clean water inlet filter. 	Colorful light doesn't work	<ol style="list-style-type: none"> 1.The circuit of light connection is break or the lamp seat is loose. 2.The light board is broken. 	<ol style="list-style-type: none"> 1.Replace it or re-fasten it. 2.Replace.
The pop-up water outlet valve can't pop-up or it is leaking	<ol style="list-style-type: none"> 1.The waste cover is leakage, the screw is loose or the water divert adjusts too low. 2.The pulling cord of water outlet is broken. 3.The washer is uneven. 	<ol style="list-style-type: none"> 1.Take off the stopper of pop-up water outlet valve, fasten the screws or adjust the top hole to the proper place. 2.Replace with new rubber. 3.Dismantel the water outlet, level the washer and re-install it. 	Ventilator doesn't work	<ol style="list-style-type: none"> 1.Plug is off. 2.Fan blade is blocked. 3.Ventilation fan broken. 	<ol style="list-style-type: none"> 1.Re-plug in. 2.Drive the fan gently after opening. 3.Replace broken ventilator.
Display panel doesn't work	<ol style="list-style-type: none"> 1.Power off or wrong wiring. 2.Switched off. 3.Wire connection to control box is loose. 	<ol style="list-style-type: none"> 1.To provide power supply and do correct wiring. 2.Turn on the switch. 3.Refasten the wiring connection. 			