



AIR SUSPENSION LEAF HELPER

Thank you for purchasing an Airbag Man air helper suspension kit. You have purchased a quality product from Australia's number one air suspension specialist backed by the world's leading airbag manufacturers.

This manual will provide answers to some of your questions regarding the use and operation of your new air suspension kit. Following the guidelines in this manual will help provide you with many years of trouble-free service.

PRODUCT MANUAL

CONTENTS

WARNINGS & IMPORTANT INFORMATION

GENERAL OPERATING INSTRUCTIONS

MAINTENANCE

AFTER SALES SERVICE

TROUBLE SHOOTING

PLEASE FIND IN THE FITTING INSTRUCTIONS:

**AIRBAG OPERATING HEIGHT
& MAXIMUM PRESSURE**

9 Hinkler Court
BRENDALE QLD 4500
AUSTRALIA

PO Box 5883
BRENDALE DC QLD 4500
AUSTRALIA







Ph 07 3889 6556
Fax 07 3889 6557
Int +61 7 3889 6556

info@airbagman.com.au
Visit our website at
airbagman.com.au

Clamp Industries Pty Ltd ABN 78071834145 T/A Airbag Man



WARNINGS & IMPORTANT INFORMATION

	This Airbag Man air suspension system is designed as assistance to the original vehicle manufacturer's suspension – it is not meant to carry the entire rated load. We do not recommend that leaves be removed from the original manufacturers suspension supplied.
	It is recommended by Airbag Man that only a properly qualified person installs the product and carries out maintenance. If you are not qualified and attempt to carry out such work ensure that all safety equipment is used and safety standards are met.
	The safety of the vehicle and compliance with relevant State & Federal regulations is the responsibility of the vehicle owner.
	If your vehicle is fitted with a brake proportioning valve or stability control system it is important to ensure this is maintained and adjusted according to the vehicle manufacturer's instructions.
	Never exceed the manufacturer's weight ratings for the overall vehicle (GVM) or individual axles. Ensure you are fully conversant with how to position load on your vehicle. A vehicle loaded in an improper manner can greatly affect safety & stability and may result in twisting and stress on the chassis and overloading of axles resulting in injury and / or vehicle damage.
	When operating your air suspension ensure there is no one close to or under the vehicle or they may be trapped and injured. Never drive with the air suspension fully inflated and or with the vehicle raised over the Airbag Operating Height. Read the operating instructions carefully before using the system or driving the vehicle.
	Never inflate an airbag assembly unrestricted. Improper use or over inflation may cause property damage or severe personal injury.



DOCUMENTATION TO BE KEPT WITH THE VEHICLE

It is very important that the vehicle owner or any driver is advised on how to use the system and that this Product Manual and Fitting Instructions, showing Airbag Operating Height & Maximum Pressure, provided with the kit is given to them and kept with the vehicle.



WARNING STICKER

This is supplied with the kit and is required to be adhered to the vehicle to notify any potential driver that it has an air suspension system fitted. It is important that any driver is fully conversant with the system before driving the vehicle.

MUST PLACE PROMINENTLY IN SIGHT OF THE DRIVER

THIS VEHICLE IS FITTED WITH AIR SUSPENSION



IMPORTANT INFO

OWNER/OPERATOR



DO NOT ATTEMPT TO DRIVE THE VEHICLE UNLESS YOU ARE FULLY FAMILIARISED WITH THE SYSTEM & IT'S OPERATION.



HOW TO OPERATE

PRESSURES HEIGHTS OWNERS MANUAL

SCAN QR CODE



ENTER SKU BELOW

airbagman.com.au

GENERAL OPERATING INSTRUCTIONS

HOW TO USE YOUR SUSPENSION

When you add or remove load to your vehicle the manufacturer's suspension height changes with the weight of the load. You are now able to maintain the manufacturer's suspension height front to back and side to side under these differing load conditions (heights) by simply adding or removing air to and from the airbags. **Airbag Operating Height & Maximum Pressure can be found in the Fitting Instruction document.**

Under load – maintain your vehicle at **Airbag Operating Height** by adding air to each airbag in turn.

When load is removed - simply remove air from both the airbags to return to the **Airbag Operating Height**.

Use only enough air pressure in the airbags to maintain the **Airbag Operating Height**. This amount will vary depending on the load, location of the load & the condition of existing suspension.



It is not uncommon to have a pressure difference between the airbags after the vehicle has been brought to the Airbag Operating Height. If this is too great check inflation and redistribute your load more evenly.

MAINTAIN AIRBAG OPERATING HEIGHT BY ADJUSTING AIRBAG PRESSURE

Always maintain the **Airbag OPERATING HEIGHT** under all loads



Load the vehicle within it's legal payload

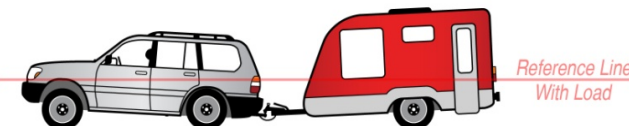

Inflate, returning the vehicle to **Airbag OPERATING HEIGHT** within the **Airbag MAXIMUM PRESSURE**

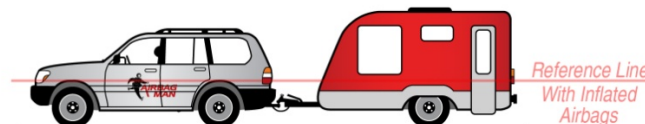

AIRBAG OPERATING HEIGHT & MAXIMUM PRESSURE
can be found in the Fitting Instruction document or via our website



The Airbag Operating Height relates to the manufacturer's suspension height. Worn, damaged or mismatched suspension components are to be addressed to ensure the correct height can be achieved and maintained across the vehicle.

INFLATING & DEFLATING THE AIRBAGS

(See Airbag Operating Height & Maximum Pressure)

- ⚠ Before adjusting air pressure ensure no-one is near or under the vehicle, as they may become trapped or injured.**
- ⚠ NEVER over inflate the airbags or damage may occur. (See Airbag Operating Height & Maximum Pressure).**

We highly recommend the addition of an onboard air control with our air suspension products. If your vehicle is equipped with such a control system, please refer to that device's instructions. Otherwise for manual inflation:

- Locate where the airbag inflation valves have been situated on your vehicle. These are a similar valve to those used to inflate your tyres and therefore the same inflation tool will be ok to use. See opposite.
- With the airbags installed on your vehicle and the vehicle sitting on a level surface, verify that the Airbag Operating Height is correct (See Airbag Operating Height & Maximum Pressure). If required, the Airbag Operating Height can be achieved by inflating the airbags using an air source such as a standard tyre inflator.
- Ensure the airbags are not inflated above the Maximum Pressure (See Airbag Operating Height & Maximum Pressure)
- Each airbag usually has a separate inflation valve.
- To maintain the Airbag Operating Height from front-to-back, add air pressure to both airbags in equal amounts gradually.
- To maintain the Airbag Operating Height from side-to-side, add more air pressure in small quantities, checking the pressure and height frequently.
- An airbag requires much less air volume than a tyre, and therefore will inflate/deflate much more quickly.



- ⚠ Never ride with the vehicle raised over the Airbag Operating Height.**
- Inflate the airbags only enough to maintain Airbag Operating Height, over-inflation to raise the vehicle above the Airbag Operating Height may result in un-predictable braking, handling and/or become unstable, resulting in greater accident risk.
- ⚠ Never overload your vehicle or exceed the manufacturer's weight ratings.**
- Never exceed a manufacturer's stated or Legal Gross Vehicle Mass or Axle Capacity (Weight Ratings). The manufacturer's weight ratings are stated on the specification plate on the vehicle. You should weigh your vehicle on an authorised weighbridge when it is fully loaded and in a level condition to determine if you are exceeding the manufacturer's weight ratings.
- ⚠ Incorrect use of this air suspension product can result in damage to the airbag, associated parts and / or the vehicle which is not covered under warranty.**
- ⚠ Ensure the airbags are always maintained at the stated Operating Height at all times and never exceed the Maximum Pressure. (See Airbag Operating Height & Maximum Pressure)**
- ⚠ An airbag operated below or above the stated Operating Height or over/under pressurised can result in airbag failure or vehicle damage. This is not covered under warranty.**
- ⚠ Ensure you load your vehicle evenly and safely within manufacturer's specifications.**



MAINTENANCE

- ⚠ **It is recommended that only a properly qualified person installs the product and carries out maintenance.**
- ⚠ **Periodically inspect your air suspension for operation, security, possible damage & component integrity**

As with your vehicles tyres, an airbag is a pneumatic device that supports a portion of the vehicle's weight. The airbag may fail as a result of punctures, impact damage, improper inflation, improper installation or improper usage. To reduce the risk of failure, we strongly recommend the following:

- Inspect and wash any accumulated sand, gravel or other road debris from the airbags and brackets.
- ⚠ **Never inflate an unrestrained airbag and fully deflate the airbags if:**
 - It is necessary to lift the vehicle by the chassis.
This will allow the airbag to extend to their maximum length without being damaged. The uninflated airbags are capable of supporting the weight of the axle when the vehicle is lifted by the chassis.
 - If you are going to remove an airbag or other component from the suspension:
Whilst securely installed in the vehicle inspect the inflated airbags to verify that they avoid contact with any other component on the vehicle under all expected operating conditions and pressures.
There must be at least 13mm (1/2") of clearance all round.
- **If an airbag has failed while you are travelling STOP in a safe manner and place to effect a repair.** Readjust the air in the remaining airbag. You will now be operating on the original suspension as the vehicle manufacturer intended until a repair can be made. It is recommended to operate your vehicle at reduced speeds to avoid further damage to your vehicle or suspension. In all cases high speed over rough roads may result in severe bottoming out of the airbags causing damage.
- ⚠ **Never cut, weld or modify the airbag or associated parts without approval from Airbag Man.**
- ⚠ **Do not use aerosol tyre repair products in airbags. If there is a hole the airbag must be replaced.**
- ⚠ **Do not use a tyre patch of any kind on an airbag. If there is a hole the airbag must be replaced.**
- ⚠ **Never weld within sight of an un-protected airbag; they are severely affected by weld UV & heat.**

EXHAUST HEAT

- Inspect the airline tubing and the airbags to verify that they have not been damaged due to exposure to heat from the exhaust system. The standard kit design takes into consideration a standard exhaust and normal use.
- ⚠ **Exhaust modifications from standard or incorrect fitment can cause eventual heat damage issues.**
- Should you have the exhaust system modified this may result in increased heat exposure to the airbags, which may reduce the life span. Please contact Airbag Man before any exhaust modifications are carried out.

TORQUE SPECIFICATIONS

Use a torque wrench for tightening fixings and only tighten to the relevant specification for the size and thread otherwise damage may occur.

SELF LOCKING FASTENERS

The air suspension system may include a variety of self-locking threaded fasteners.

Prevailing-torque lock nuts may be more difficult to install or remove, but will not come loose under normal suspension operation. Note that Nylok™ type lock nuts may be used in this manner also, in place of the prevailing-torque type, except where high heat is present.

Spring washers - In order to properly use a lock washer, tighten the nut/bolt fastener following the torque recommendations above.

Thread Locking Compound - The hex bolts used to secure the airbag to the brackets may have a locking compound applied to the threads. Lock washers are not required when using a fastener with pre-applied thread locking compound. If you need to remove such items, ensure similar locking compound.

- ⚠ **All locking systems will be compromised in their ability to stay tight if they are used more than once therefore it is recommended in such instances to replace with a new part.**

FITTINGS & TUBING

Your kit will include push-to-connect air fittings. Some fittings are able to be swivelled to align the push-to-connect fitting to the airline. The supplied air fitting in the air entrance hole on the top plate (stud end) of the airbag has a nylon ring which contacts the top plate sealing when tightened.

Additional thread sealant is not normally needed, however can be used if these fittings are re-used as this will degrade their nylon sealing ability.

- ⚠ **Always ensure all air is removed from the system prior to attempting to remove the airline, airbags and or fittings.**

If you need to disconnect the airline:

- **Removal** - Push the collet towards the body of the fitting, and then hold in that position whilst pulling the airline out.
 - **Refit** - Cut the airline as square as possible using a sharp blade or proper tube-cutter. Push the recut airline into the fitting as far as possible.
 - **If you use a sharp utility knife or razor blade great care must be taken in all cases not to cut yourself during this operation.**
- ⚠ **Any damage to the airline section that enters the fitting will cause a leak and must be trimmed to a clean, straight airline section.**

ENSURE SCRATCH-FREE STRAIGHT AIRLINE FOR PUSH TO CONNECT FITTING SEAL

The Push To Connect fitting houses an o-ring and collet to seal and secure the nylon airline.

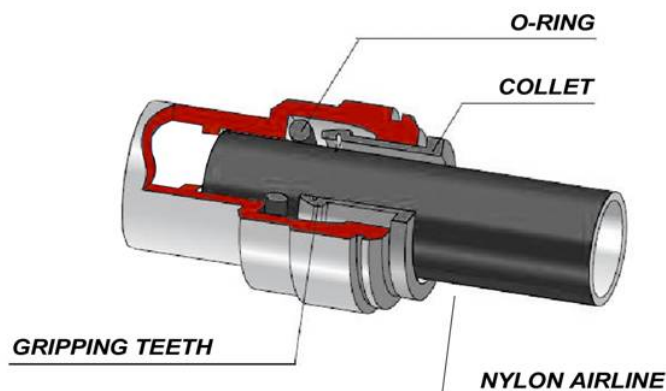

AIR LEAK CHECK

- **It is normal for an airbag system to permeate air and lose pressure over time. Please ensure the Airbag Operating Height is maintained and any excessive leaks are checked and repaired. Note: pressure loss occurs each time it is checked. (See Airbag Operating Height & Maximum Pressure)**
 - If you encounter an air leak or have carried out repairs to the air system a leak check has to be performed.
 - Inflate the airbags to the maximum allowed pressure and spray all components with soapy water mix.
- ⚠ **Ensure airbags are adjusted to the Airbag Operating Height after any test and before driving.**



AFTER SALES SERVICE

GENERAL ADVICE & ASSISTANCE

Airbag Man is proud to offer the best quality products and customer service. If you have any issue with our product you must call us to discuss a solution and local service if required.

Also see the Trouble Shooting Guide in this booklet for assistance before calling.

SPARE PARTS

We carry an extensive range of spare parts and have knowledgeable service dealers throughout the country. Should you require spare parts please **locate the kit part number** found in the fitting instructions and call us for assistance.

WARRANTY

Our Warranty operates in addition to (and does not exclude, restrict or modify) any rights or remedies to which you may already be entitled under the Australian Consumer Law or any other relevant law relating to this product. Our Goods come with guarantees that cannot be excluded under the Australian Consumer Law.

If the product supplied has not performed as expected and you suspect it may fall into the consumer protection category please call **1800 247 224** for assistance.

FOR SUSPECTED WARRANTY CLAIMS - PLEASE CONTACT AIRBAG MAN BEFORE REPAIRS ARE CARRIED OUT FOR ADVICE AND A CLAIM FORM WHICH MUST BE COMPLETED. FREECALL 1800 247 224



**AFTER SALES & SERVICE
FREECALL 1800 247 224**



TROUBLE SHOOTING GUIDE

Airbag will not inflate

Do you have a good air supply?

Make sure all connections are made.

Check for dirt in the valve core and correct operation of the valve.

Check that the inflation valve is mounted to leave enough thread depth for the inflator to operate it. If mounted through material thicker than 5mm it may not allow the valve to open. (Relocate)

Inspect entire length of tubing to make sure tubing is not trapped, melted together or cut from rubbing on sharp edges.

If you have an air supply system other than manual inflation refer to the relevant document for information.

Airbag will not hold air

Air loss is expected each time the airbag pressure is checked.

Check to see if the valve core is tight. The inflation valve cap can be used as valve core tool.

If loss of air is excessive a solution of 25% soap and 75% water can be used to inspect the airlines, fittings, and airbags. Look for air bubbles forming in these areas and obvious leaks visually.

Finding a stubborn leak

With the airbags on the vehicle, inflate to the maximum allowed pressure then start at one end of the airline and inspect for leaks. A solution of 25% soap and 75% water can be used. Apply the soap solution to all air fittings, valve core and the airbag. Rinse the solution from the system when complete.

(See Airbag Operating Height & Maximum Pressure)

Common location of air leaks

Air leaks are often due to damaged airline installed into the fitting which must be repaired by re-trimming to a clean section of airline. Leaks can also occur in the attachment of the air fittings to the airbags due to the fittings not being tight enough or sealed with thread sealant. Tighten the fittings one more turn or remove and apply a suitable thread sealant.

Tubing must be cut squarely to avoid burrs in the connection to the air fittings. Push-to-connect fittings require a square cut to assure a seal. With air pressure removed the tubing can be easily removed by applying pressure to the brass collar toward the fitting, the tubing can then be pulled freely from the fitting. To install the tubing, make sure that the tubing is cut squarely and push into the fitting as far as possible.

The vehicle is not level

Check for proper inflation of the airbags to Operating Height on each side.

Check for obstruction or components that may be restricting the suspension.

⚠ Ensure airbags are adjusted to the Airbag Operating Height after any test and before driving.



**AFTER SALES & SERVICE
FREECALL 1800 247 224**

9 Hinkler Court
BRENDALE QLD 4500
AUSTRALIA

PO Box 5883
BRENDALE DC QLD 4500
AUSTRALIA

Ph 07 3889 6556
Fax 07 3889 6557
Int +61 7 3889 6556

info@airbagman.com.au
Visit our website at
airbagman.com.au

Clamp Industries Pty Ltd ABN 78071834145 T/A Airbag Man