

# Molteni & C

## REVERSI '14 — STUDIO HANNES WETTSTEIN 2014

1—  
7



Reversi '14, designStudioHannesWettstein:StephanHuerlemann&SimonHusslein, amodular, linearsofawhich builds on previous experience in a project that keeps pace with current trends. A demand for more softness, wide armrests, and high-tech padding. The seating depth is adjustable thanks to the movement of the backrest mechanism, and allows you to create, both a workspace and a welcoming relaxing space in a single sofa.

### DATASHEET

REGISTERED  
DESIGN

IX.2018

[moltenigroup.com](http://moltenigroup.com)

Dimensions in centimeters and inches. The right to discontinue and make changes is reserved. This information is based on the latest product information available at the time of printing.

## FINISHES

### COVERS

fabric - leather, completely removable.

### BASE FINISHES

shiny aluminium - black chrome - pewter colour

Available in fire-resistant version (TB117 and BS5852).

# Molteni & C

## TECHNICAL INFORMATION

### STRUCTURE INTERIOR

Frame made of solid Fir (Picea abies) and chipboard, with elastic straps.

### STRUCTURE PADDING

High capacity variable density foam polyurethane. Light velvet cover.

### SEAT CUSHIONS

Insert in shaped polyurethane and sterilised feathers. 100% cotton cover.

### BACK CUSHIONS

Polyester fibre, sterilised feathers. 100% cotton cover.

### FEET

Shiny aluminium, black chrome or painted pewter colour with plastic stand.

### REMOVABLE OUTER COVER

(See attached card, specifically for the cover).

2—  
7

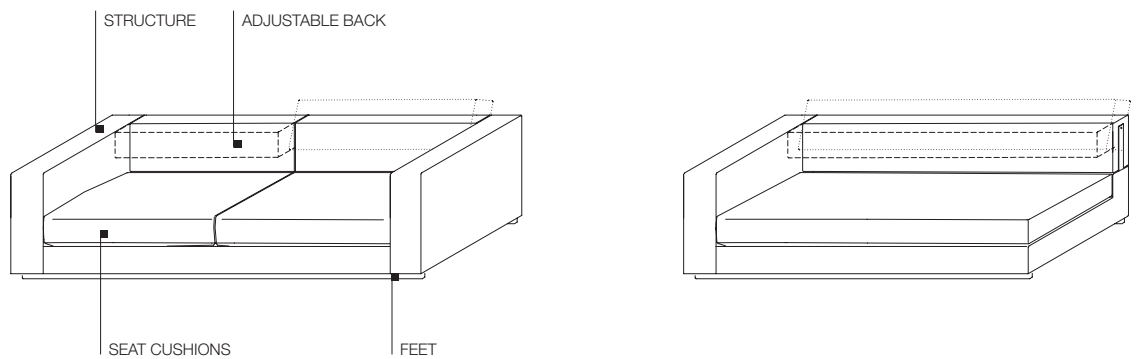

## DATASHEET

REGISTERED  
DESIGN

IX.2018

REVERSI '14—  
STUDIO  
HANNES  
WETTSTEIN  
2014

Molteni & C

**DIMENSIONS**

**Sofa with 2 backrests with mechanism**

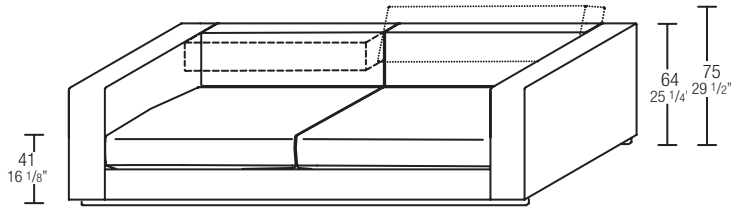

**Notes**

Compositions are always closed at the side with an arm

3—  
7

**End element with 1 backrest with mechanism**

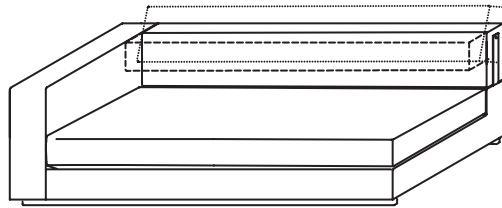

**Example of composition with corner**

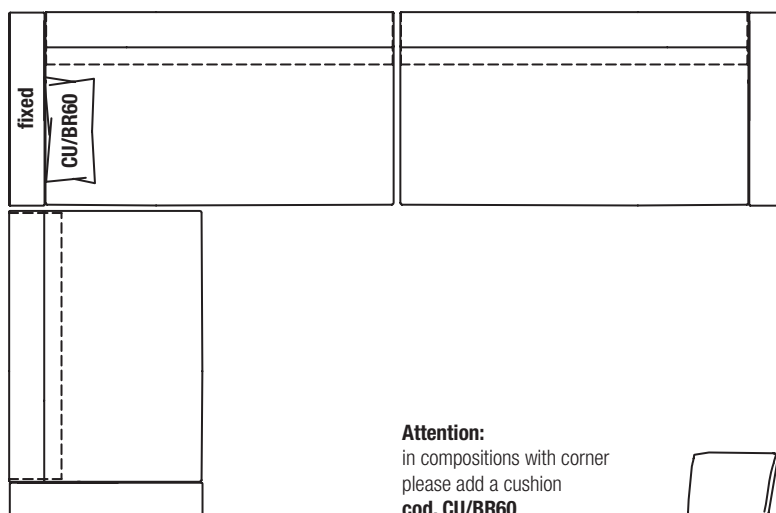

**Adjustable back positions**

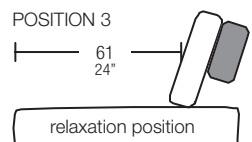
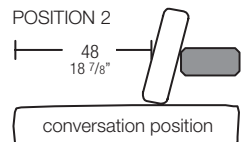
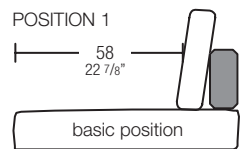

**DATASHEET**

REGISTERED  
DESIGN

IX.2018

[moltenigroup.com](http://moltenigroup.com)

Dimensions in centimeters and inches. The right to discontinue and make changes is reserved. This information is based on the latest product information available at the time of printing.

**DIMENSIONS**

**Please note**  
Sofas **DV180A** and  
**DV180B** the back  
structure is always  
in one piece

**sofa**

**DV180A**

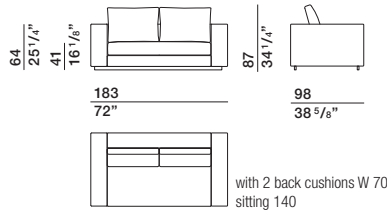

**DV180B**

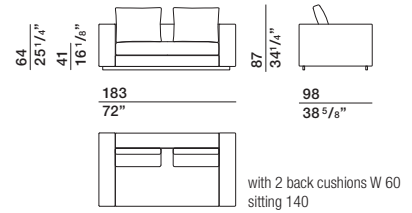

**sofa**

**DV200A**

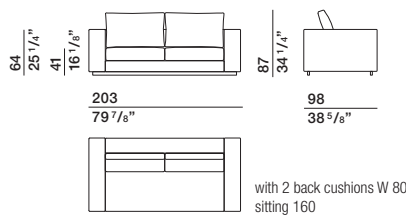

**DV200B**

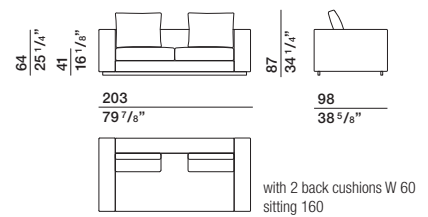

**sofa**

**DV220A**

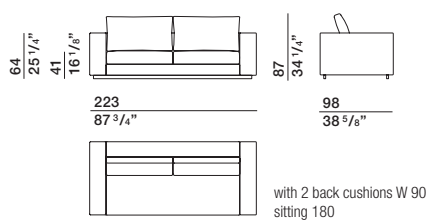

**DV220B**

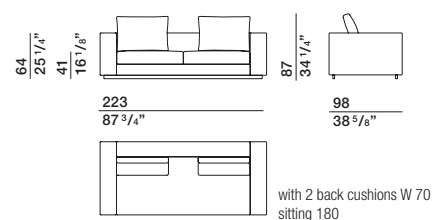

**sofa**

**DV240A**

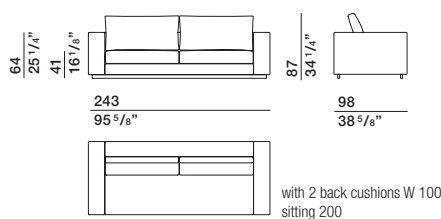

**DV240B**

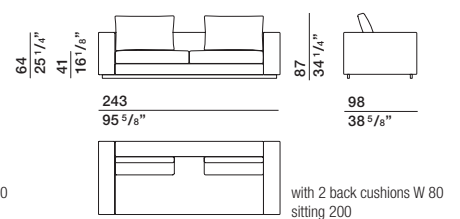

**sofa**

**DV260A**

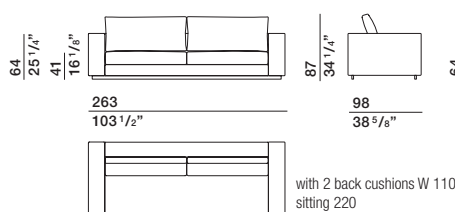

**DV260B**

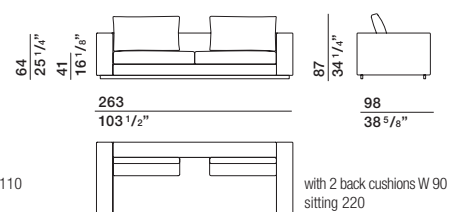

**pouf**

**PF95**

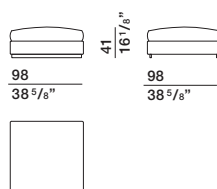

**PF115**

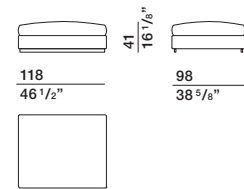

Molteni & C

4—  
7

**DATASHEET**

REGISTERED  
DESIGN

IX.2018

**DIMENSIONS**

**Notes**

These elements cannot be used alone

**end element**

**T140A dx - sx**

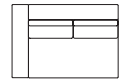
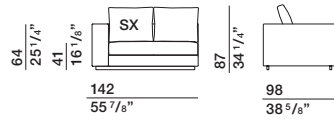

**T140B dx - sx**

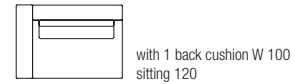
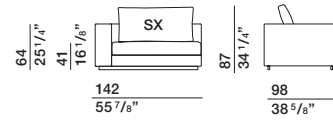

**Notes**

These elements cannot be used alone

**end element**

**T160A dx - sx**

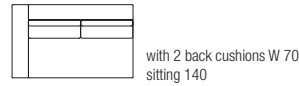
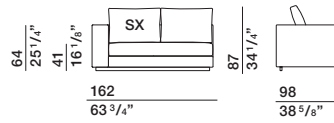

**T160B dx - sx**

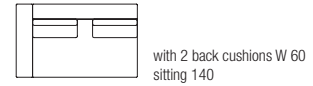
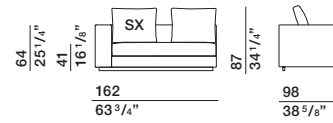

**Notes**

These elements cannot be used alone

**end element**

**T180A dx - sx**

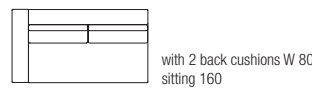
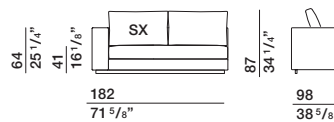

**T180B dx - sx**

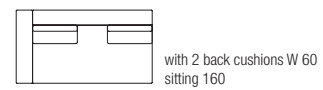
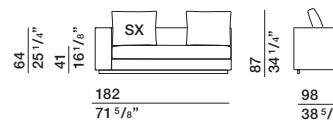

**Notes**

These elements cannot be used alone

**end element**

**T200A dx - sx**

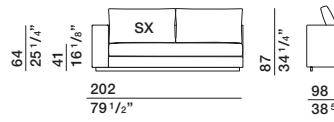

**T200B dx - sx**

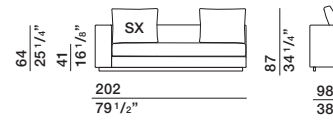

**Notes**

These elements cannot be used alone

**end element**

**T220A dx - sx**

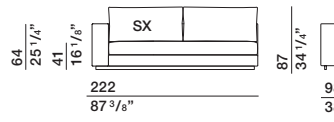

**T220B dx - sx**

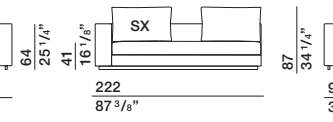

**Notes**

These elements cannot be used alone

**end element**

**T240A dx - sx**

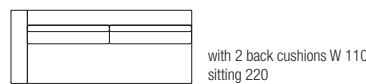
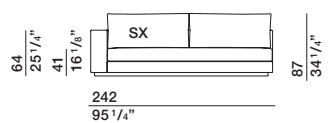

**T240B dx - sx**

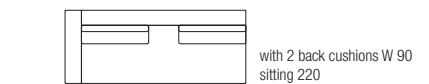
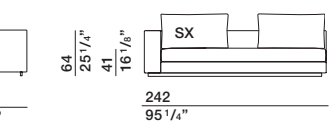

**DATASHEET**

REGISTERED  
DESIGN

IX.2018

**DIMENSIONS**

**Notes**

These elements  
cannot be  
used alone

**chaise longue**

**CL200A dx - sx**

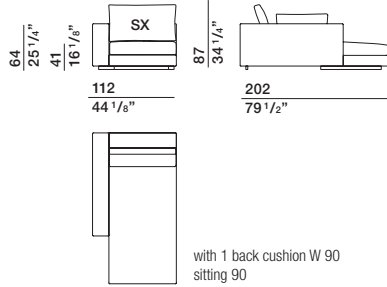

**CL200B dx - sx**

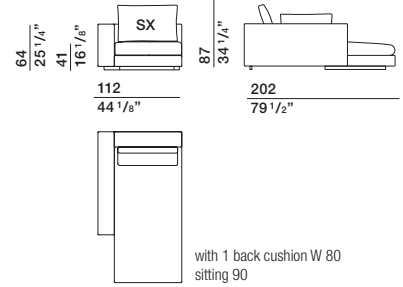

**optional armrest  
cushion for CL200**

**CU/BR80**

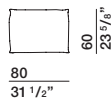

**Notes**

These elements  
cannot be  
used alone

**chaise longue**

**CL160A dx - sx**

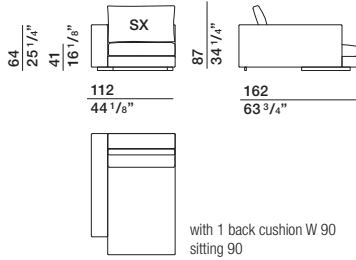

**CL160B dx - sx**

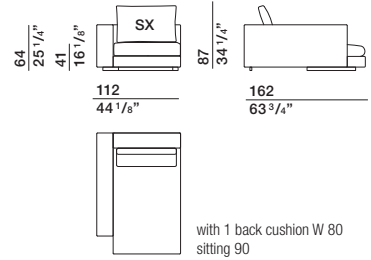

**pair of additional  
cushions**

**CCQ/50**

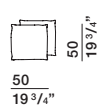

**additional  
cushion**

**CU/60**

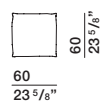

**additional  
cushion**

**CU50/40**

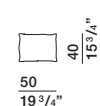

**additional cushion  
for compositions with corner**

**CU/BR60**

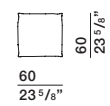

Molteni & C

**SAMPLE COMPOSITIONS**

**composition 1**

chaise longue CL200A sx  
end element T200A dx  
cushion CU/BR80

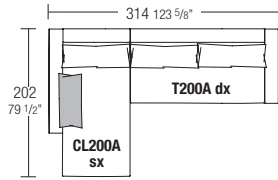

R4C01

**composition 2**

chaise longue CL200A sx  
end element T220A dx  
cushion CU/BR80

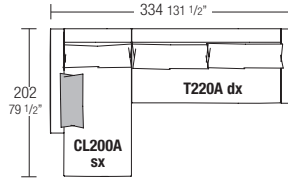

R4C02

**composition 3**

chaise longue CL160A sx  
end element T180A dx

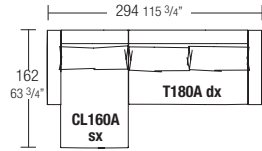

R4C03

**composition 4**

chaise longue CL160A sx  
end element T200A dx

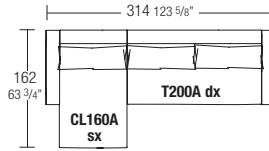

R4C04

**composition 5**

end element T160B sx  
sofa DV260B  
cushion CU/BR60

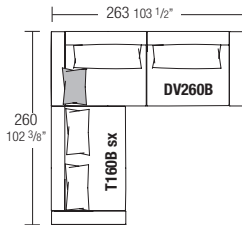

R4C05

**composition 6**

2 end elements T140A sx  
end element T140A dx  
cushion CU/BR60

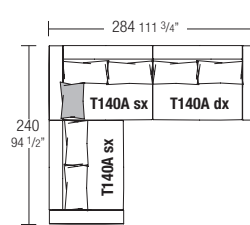

R4C06

**composition 7**

2 end elements T160B sx  
end element T160B dx  
cushion CU/BR60

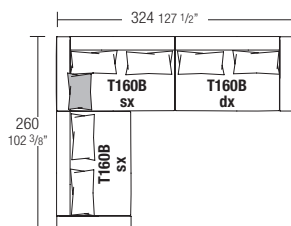

R4C07

**composition 8**

end element T240B sx  
end element T180B sx  
end element T180B dx  
cushion CU/BR60

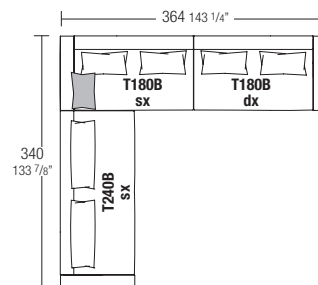

R4C08

**composition 9**

end element T240B sx  
end element T200B sx  
end element T200B dx  
cushion CU/BR60

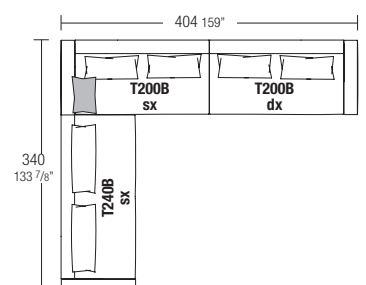

R4C09

**DATASHEET**

REGISTERED  
DESIGN

IX.2018