

# Molteni & C

## HUBERT — VINCENT VAN DUYSSEN 2019

1—  
2



Set of small tables specifically designed by Vincent Van Duysen to go with the Gregor sofa. They echo the rounded angles of the sofa to create a harmonious whole. Square or rectangular, these are occasional tables each with two wooden horizontal tops, supported by curved hide leather-covered vertical elements, which form a partially closed compartment between the top and the shelf below, designed to hold various handy objects for those sitting on the sofa.

### DATASHEET

REGISTERED  
DESIGN

IX.2019

**FINISHES**

WOODEN TOP FINISHES

eucalyptus  
walnut

BONDED HIDE LEATHER FINISHES

ivory  
dark brown  
natural  
mud green  
dove grey  
black

**TECHNICAL INFORMATION**

TOPS

Chipboard panel, shaped and covered with wood veneer in eucalyptus (*Eucalyptus Globulus*) or walnut (*Juglans Nigra*). The lower shelf sets on the floor on adjustable plastic feet.

CORNER SUPPORTS

Inserts in curved metal sheet covered in bonded hide leather.

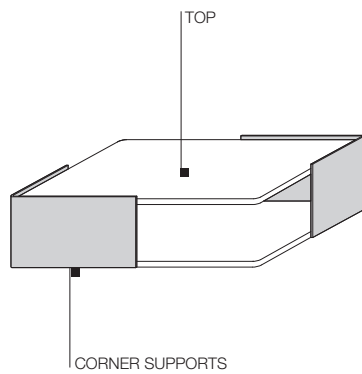

**DIMENSIONS**

rectangular small tables

**HTA1**

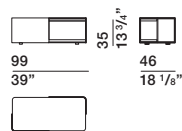

**HTA2**

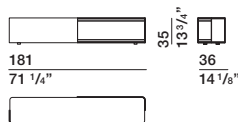

**HTA3**

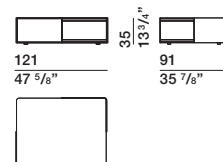

square small tables

**HTA4**

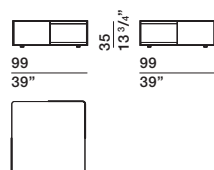

**HTA5**

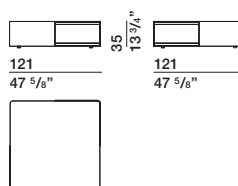

**HTA6**

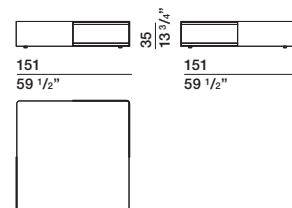

**DATASHEET**

REGISTERED  
DESIGN

IX.2019