

# Molteni & C

## GREGOR — VINCENT VAN DUYSSEN 2019

1—  
9



Vincent van Duysen continues his research into the world of contemporary living by designing this Gregor modular system for Molteni&C. It includes various straight, corner or peninsular units that can be mixed and matched together to give multiple combinations for a living space destined for conversation, reading and entertainment, with all the media devices readily available. The multiple features distinguishing this range underline the overall lightness of the design. The steel base, in a new zinc finish, supported by small feet that recall VVD's most recent furniture designs, such as the Quinten sideboards or the Jan small tables, is covered in leather, as are the winged armrests suitable for supporting soft cushions while at the same time acting as a useful surface.



This symbol shows that the product has removable upholstery. Only qualified personnel can remove the upholstery of some of our products. If this information is pertinent, it will be included in the warnings section.



This symbol shows that the product is available on request in a fire resistant version that complies with the standards BS 5852 and TB 117-2013. The buyer is responsible for checking to make sure that the product is suitable and compliant with the requirements for the designated use and the current applicable laws and standards for the destination and use of the product.

**DATASHEET**

REGISTERED  
DESIGN

IX.2020

**moltenigroup.com**

Dimensions in centimeters and inches. The right to discontinue and make changes is reserved. This information is based on the latest product information available at the time of printing.

## FINISHES

### BASE FINISHES

painted zinc  
painted pewter colour

## TECHNICAL INFORMATION

### BASE

Painted electro-welded steel with plastic floor slides.

### UNDERSEAT STRUCTURE

Shaped plywood panel with elastic straps and high density polyurethane top filler.  
Cover in polyurethane bonded with polyester fibre.

### INTERNAL STRUCTURE OF PADDED PARTS

Frame made of solid spruce (Picea abies) and particle board panels.

### STRUCTURAL PADDING OF PADDED PARTS

High performance variable density polyurethane foam. Cover in bonded velveteen.

### SEAT CUSHION

Insert in shaped polyurethane and sterilized feathers. Case in 100% cotton.

### BACK CUSHIONS

Solotex. Case in 100% cotton.

### WING-SHAPED ARMREST

Metal load-bearing frame with cold-moulded polyurethane foam padding and cover in cotton/polyester fibre.

### HEADREST FIXED

Shaped plywood panel. Cover in polyurethane bonded with polyester fibre.

### HEADREST BOLSTER CUSHION

Polyurethane foam with high bearing capacity. Cover in bonded velveteen.

### REMOVABLE OUTER COVER

(See enclosed sheet, specific for the cover in question).



AVAILABLE IN FIRE-RESISTANT  
VERSION TB117 AND BS5852

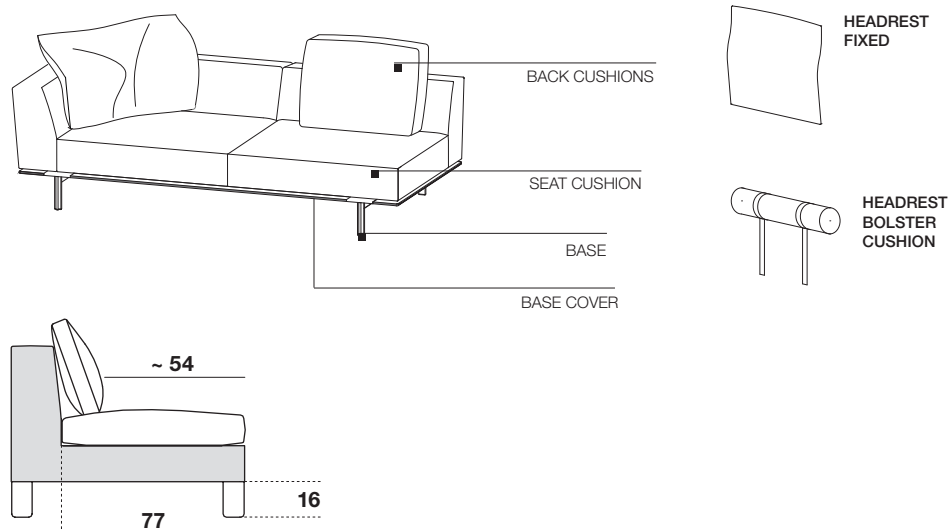

## DATASHEET

REGISTERED  
DESIGN

IX.2020

Seat depth for structure only, 77 cm

Seat depth with backrest cushion, ~ 54 cm

Feet high 16 cm (from ground to under seat)

**NOTES**

- ▶ List codes with **final A:**  
All elements covers in fabric of the same category and colour.  
All elements covers in leather of the same category and colour.
- ▶ List codes with **final B:**  
Base and armrest covers in leather / structure + cushion covers in fabric.
- ▶ The headrest bolster cushion PGR1B has a fabric bolster cushion with leather retaining straps.

**When ordering**

Specify the type of backrest.

Molteni & C

**Suggested configurations**

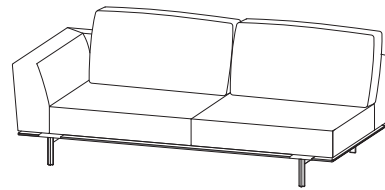
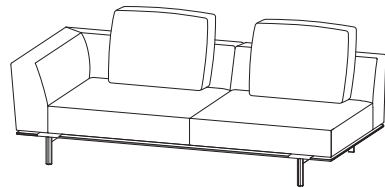
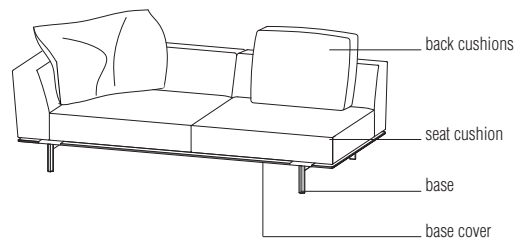

**Measurement details**

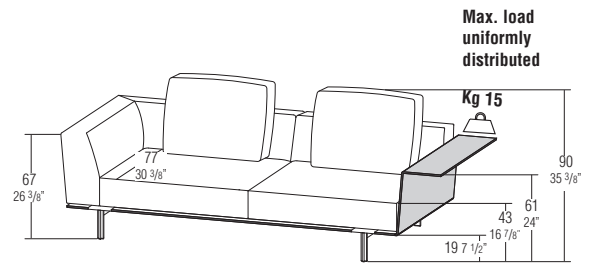

**Example of compositions**

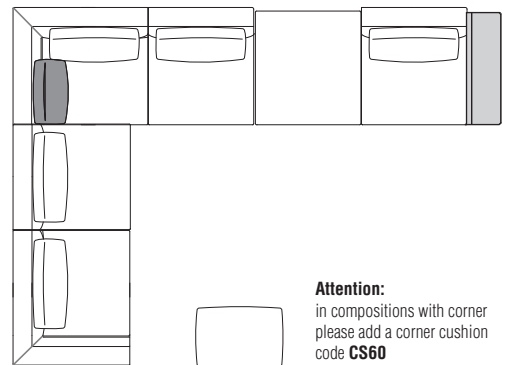

**Headrest fixed**



**Examples of use of the headrest**

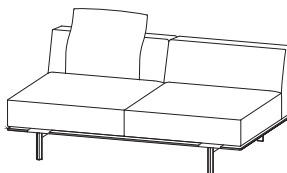

**Headrest bolster cushion**

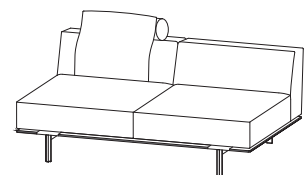
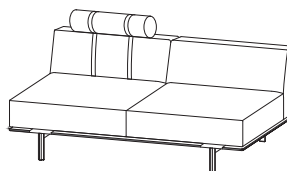
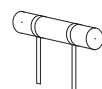

**DIMENSIONS**

Molteni & C

4—  
9

**sofa**  
DV283A DV283B

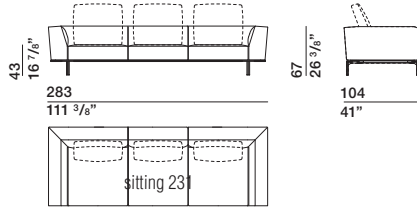

**back cushion**  
CS65

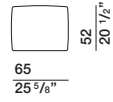

**back cushion**  
CS77

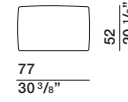

**ornamental cushion**  
PCU90/75

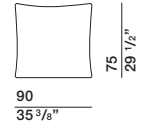

**sofa with armrests**  
DB291A DB291B

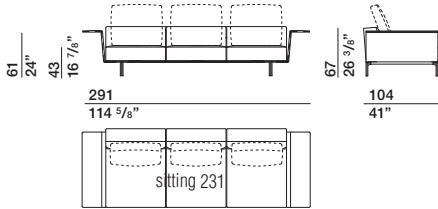

**back cushion**  
CS65

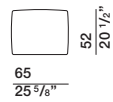

**back cushion**  
CS77

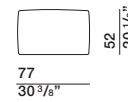

**ornamental cushion**  
PCU90/75

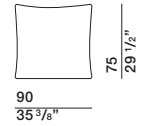

**sofa**  
DV262A DV262B

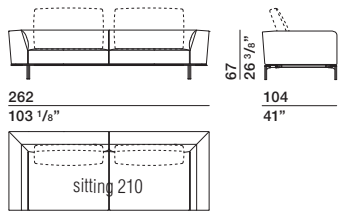

**back cushion**  
CS65

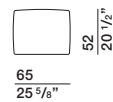

**back cushion**  
CS95

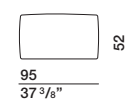

**ornamental cushion**  
PCU90/75

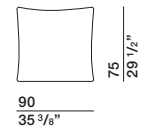

**sofa with armrests**  
DB270A DB270B

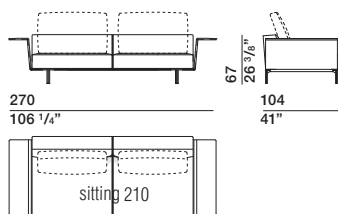

**back cushion**  
CS65

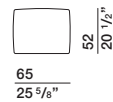

**back cushion**  
CS95

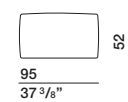

**ornamental cushion**  
PCU90/75

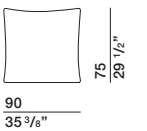

**sofa**  
DV242A DV242B

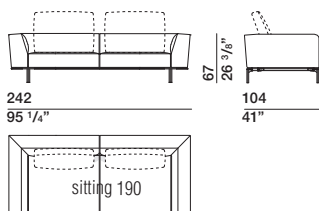

**back cushion**  
CS77

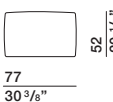

**back cushion**  
CS95

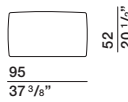

**ornamental cushion**  
PCU90/75

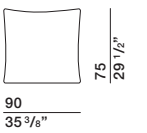

DATASHEET

REGISTERED  
DESIGN

IX.2020

**DIMENSIONS**

**sofa with armrest**

**DB246A dx-sx DB246B dx-sx**

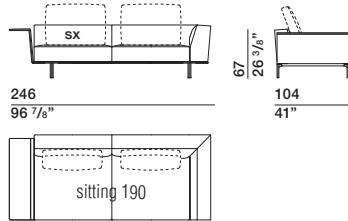

**back cushion**

**CS77**

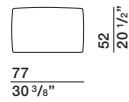

**back cushion**

**CS95**

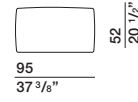

**ornamental cushion**

**PCU90/75**

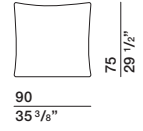

**sofa with armrests**

**DB250A DB250B**

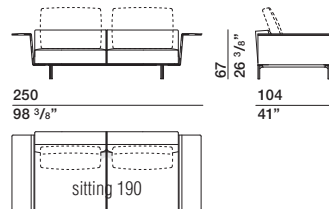

**back cushion**

**CS77**

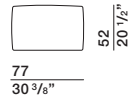

**back cushion**

**CS95**

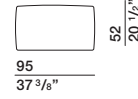

**ornamental cushion**

**PCU90/75**

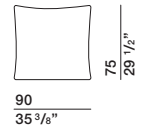

**sofa**

**DV206A DV206B**

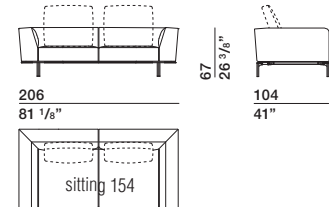

**back cushion**

**CS65**

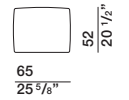

**back cushion**

**CS77**

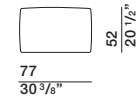

**ornamental cushion**

**PCU90/75**

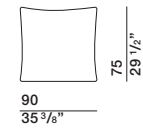

**sofa with armrest**

**DB210A dx-sx DB210B dx-sx**

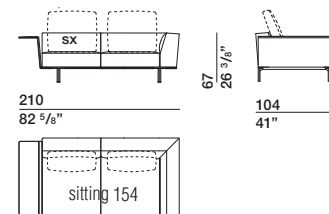

**back cushion**

**CS65**

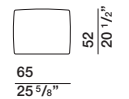

**back cushion**

**CS77**

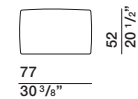

**ornamental cushion**

**PCU90/75**

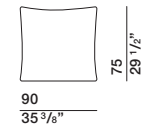

**sofa with armrests**

**DB214A DB214B**

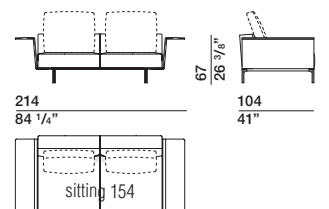

**back cushion**

**CS65**

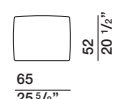

**back cushion**

**CS77**

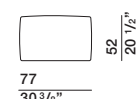

**ornamental cushion**

**PCU90/75**

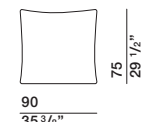

**DATASHEET**

REGISTERED  
DESIGN

IX.2020

**DIMENSIONS**

**end element**

TR216A dx-sx TR216B dx-sx

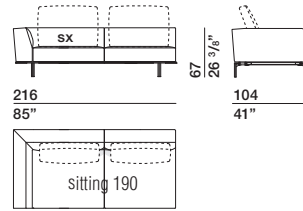

**back cushion**

CS77

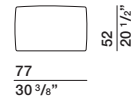

**back cushion**

CS95

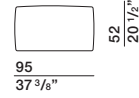

**ornamental cushion**

PCU90/75

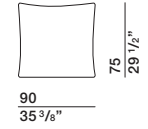

**end element**

TR180A dx-sx TR180B dx-sx

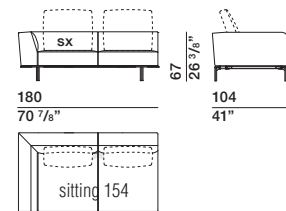

**back cushion**

CS65

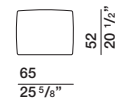

**back cushion**

CS77

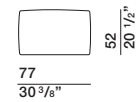

**ornamental cushion**

PCU90/75

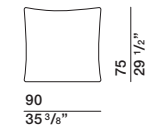

**end element with armrest**

TB220A dx-sx TB220B dx-sx

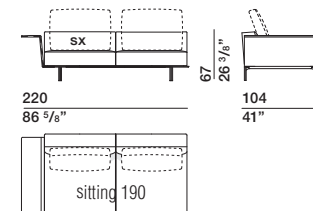

**back cushion**

CS77

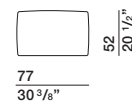

**back cushion**

CS95

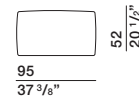

**ornamental cushion**

PCU90/75

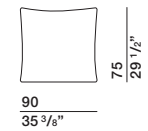

**end element with armrest**

TB184A dx-sx TB184B dx-sx

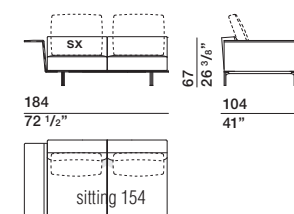

**back cushion**

CS65

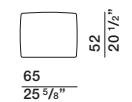

**back cushion**

CS77

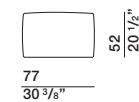

**ornamental cushion**

PCU90/75

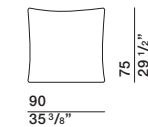

**central element**

CN191A CN191B

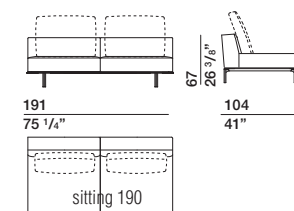

**back cushion**

CS77

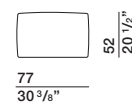

**back cushion**

CS95

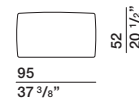

**ornamental cushion**

PCU90/75

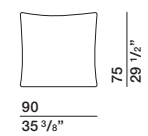

**DATASHEET**

REGISTERED  
DESIGN

IX.2020

**DIMENSIONS**

**central element**

CN155A CN155B

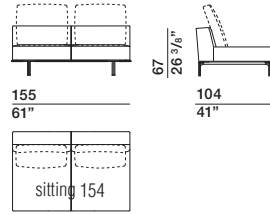

**back cushion**

CS65

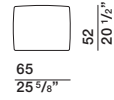

**back cushion**

CS77

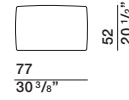

**ornamental cushion**

PCU90/75

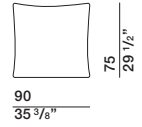

**island with armrest**

IB220A dx-sx IB220B dx-sx

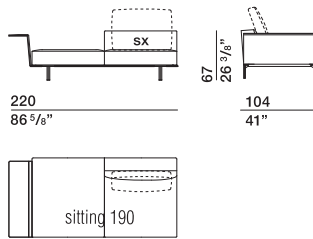

**back cushion**

CS77

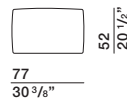

**back cushion**

CS95

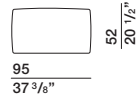

**ornamental cushion**

PCU90/75

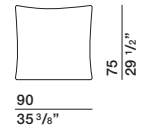

**island with armrest**

IB184A dx-sx IB184B dx-sx

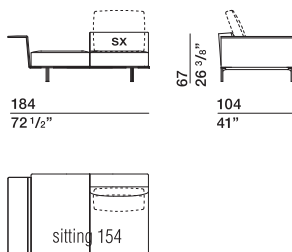

**back cushion**

CS65

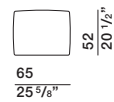

**back cushion**

CS77

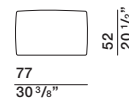

**ornamental cushion**

PCU90/75

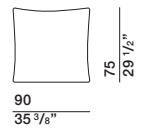

**chaise longue**

CL216A dx-sx CL216B dx-sx

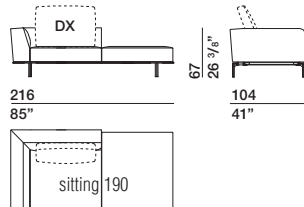

**back cushion**

CS77

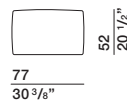

**back cushion**

CS95

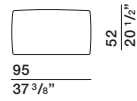

**ornamental cushion**

PCU90/75

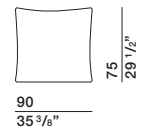

**DATASHEET**

REGISTERED  
DESIGN

IX.2020

**DIMENSIONS**

**end element with armrest**

TC220A dx-sx TC220B dx-sx

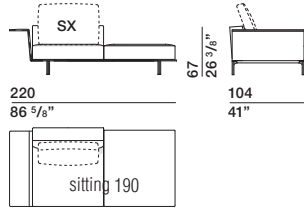

**chaise longue**

CL180A dx-sx CL180B dx-sx

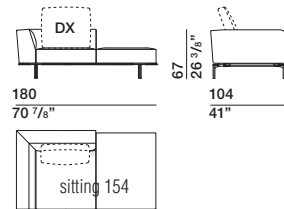

**end element with armrest**

TC184A dx-sx TC184B dx-sx

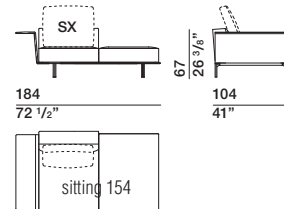

**island**

IS191A dx-sx IS191B dx-sx

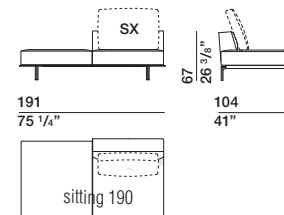

**island**

IS155A dx-sx IS155B dx-sx

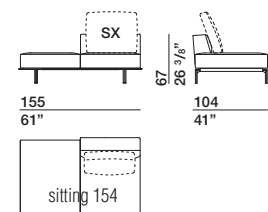

**back cushion**

CS77

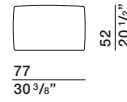

**back cushion**

CS95

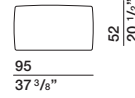

**ornamental cushion**

PCU90/75

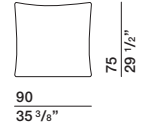

**back cushion**

CS65

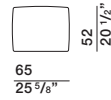

**back cushion**

CS77

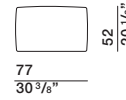

**ornamental cushion**

PCU90/75

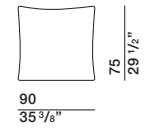

**back cushion**

CS65

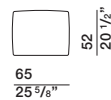

**back cushion**

CS77

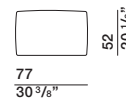

**ornamental cushion**

PCU90/75

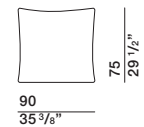

**back cushion**

CS77

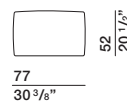

**back cushion**

CS95

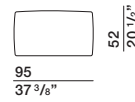

**ornamental cushion**

PCU90/75

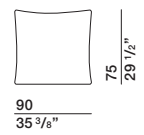

**back cushion**

CS65

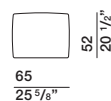

**back cushion**

CS77

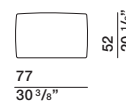

**ornamental cushion**

PCU90/75

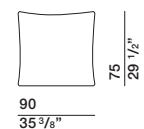



## DIMENSIONS

### pouf

PF099A

PF099B

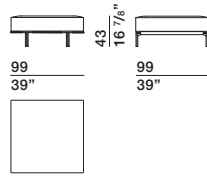

Molteni & C

### corner cushion

CS60



### headrest fixed

PGT1

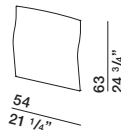

### headrest bolster cushion

bolster cushion Ø 12-4 3/4"

PGR1A

PGR1B

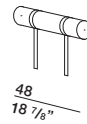

9—  
9

### ornamental cushions

#### single cushion

CU/50

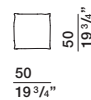

#### pair of additional cushions

CCQ/50

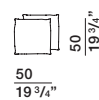

#### additional cushion

CU/60

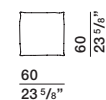

#### additional cushion

CU/50/40

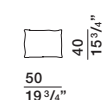

#### additional cushion

CU40/40

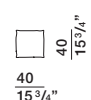

| code            | gross weight kg. | volume mc. | packages | code            | gross weight kg. | volume mc. | packages |
|-----------------|------------------|------------|----------|-----------------|------------------|------------|----------|
| DV283A - DV283B | 159              | 2,789      | 1        | TB184A - TB184B | 95               | 1,65       | 1        |
| DB291A - DB291B | 140              | 2,4        | 1        | CN191A - CN191B | 105              | 1,8        | 1        |
| DV262A - DV262B | 135              | 2,4        | 1        | CN155A - CN155B | 79               | 1,403      | 1        |
| DB270A - DB270B | 135              | 2,3        | 1        | IB220A - IB220B | 100              | 1,9        | 1        |
| DV242A - DV242B | 122              | 2,274      | 1        | IB184A - IB184B | 90               | 1,6        | 1        |
| DB246A - DB246B | 130              | 2,15       | 1        | CL216A - CL216B | 108              | 1,95       | 1        |
| DB250A - DB250B | 120              | 2,2        | 1        | TC220A - TC220B | 100              | 1,9        | 1        |
| DV206A - DV206B | 120              | 1,83       | 1        | CL180A - CL180B | 95               | 1,63       | 1        |
| DB210A - DB210B | 115              | 1,88       | 1        | TC184A - TC184B | 90               | 1,65       | 1        |
| DB214A - DB214B | 110              | 1,85       | 1        | IS191A - IS191B | 85               | 1,6        | 1        |
| TR216A - TR216B | 106              | 2,044      | 1        | IS155A - IS155B | 75               | 1,35       | 1        |
| TR180A - TR180B | 100              | 1,655      | 1        | PF099A - PF099B | 45               | 0,66       | 1        |
| TB220A - TB220B | 110              | 1,9        | 1        |                 |                  |            |          |

### DATASHEET

REGISTERED  
DESIGN

IX.2020