



PROFESSIONAL CATALOGUE
ed. 18

A-Z INDEX

	CONCEPT	COLLECTION	TECHNICAL
FURNITURE			
Air	•	44	264
Cascade		74	271
Cross alu		174	288
Cross teak		168	288
Duo		82	272
Echo		94	274
Elements	•	34	262
Fuse	•	184	290
Kobo		66	270
Kumo	•	26	260
Latona		178	289
Liner		118	279
Loop		102	275
Malibu		200	294
Mood		146	284
Moon Island	•	60	268
Radius		88	273
River		138	283
San	•	54	266
San Diego	•	192	292
Siena	•	160	286
Solid		154	285
Squat	•	124	280
St-Tropez		206	295
Swing		130	282
Versailles		210	295
Zendo	•	108	276

TABLES

Air		218	300
Capri		227	309
Fuse		220	302
Livorno		225	307
Luna		221	303
Milano		226	308
Minus		216	298
Prato		219	301
Quarto		223	305
Siena		224	306
Torsa		217	299
Trento		222	304

BISTRO TABLES

Napoli		229	310
Torsa		228	299

MULTIFIT TABLES

Mood tables		231	311
Outdoor side tables		232	312
Torsa		230	299

ACCESSORIES

Cusion boxes			319
Outdoor lighting & candles			315
Poufs			314
Rugs			318
Towel rack			313
Trays			313
Umbrellas			316

For over 16 years, we at Manutti have shared an insatiable drive to create and inspire. In fact, we are as passionate about the process as we are about the final piece. From the first sketches, the choice of materials and the creation, to the moment our outdoor furniture finds a home where it belongs.

This love for creation goes hand in hand with our attention to detail. An outdoor space is changed by our sensory experience of it. The way the fabric of a chair touches our skin or the warmth of the top of our new dining table. Handmade pieces carry those tactile experiences in them from the start. That is why, at Manutti, we value craftsmanship in all we make.

Our new collections strike a balance between inspiration and innovation. They are infused with passion and personality. From the clean-lined wood elements of our Solid Collection, the intricately handwoven ropes of our Kobo couch to the sophisticated metalwork of our Duo chair: our 2018 designs are the result of true craftsmanship, drive and high quality standards.



YOUR OUTDOOR SPACE, YOUR CHOICE

**Surround yourself with things you love.
Pieces that reflect your lifestyle and personality.
Or simply items that stand out to you.
Manutti prides itself in its wide range of
outdoor furniture for you to choose from.**

Whichever collection you prefer, each and every Manutti piece is the result of smart design, craftsmanship and a profound sense of quality. For you to be able to select your personal favourite from a vast array of durable and high-end design collections, we work with a select group of suppliers and chiefly produce in our own factories.



MANUTTI STYLE, A 3-STEP PROCESS TOWARDS CREATIVE DESIGN

Manutti knows that your style cannot be defined into one category. It's a mix of colours, shapes and materials that develop through time. That is why our designers, trendwatchers and stylists follow a simple 3-step process towards creative design. From **inspiring moodboards** based on trend colours **to the creative input of our designers** and a helpful selection of **colour combinations**.

Whichever style you prefer, each and every combination is applicable to your favourite piece. Well-considered and conscious matches ensure that your outdoor setting is tailored to your needs.

Step into our world.







FOREST



ETNIC





MARINE

THROUGH OUR DESIGNERS' CREATIVITY

These materials and colours form an integral part of the creative process of our talented team of designers, inspiring them to develop innovating and surprising pieces in true Manutti style.

DESIGNER PORTRAIT **LIONEL DOYEN**



*More than simply
aesthetic appeal*

Lionel Doyen (1978) is specialised in service, product and industrial design and product development. Since launching his own studio in September 2013, he aims to establish a more personal, more experimental approach to product design and development. In partnership with companies like Manutti, he hopes to promote a more comprehensive strategy, taking into consideration the customer's relationship with the product and its use, the innovative aspects and implementation, more than simply its aesthetic appeal. He created the Kumo, San & Solid collection.

DESIGNER PORTRAIT **GERD COUCKHUYT**



*Visual and emotional
inspiration in everyday life*

Gerd Couckhuys (1970) is a Belgian designer who finds inspiration in visual and emotional stimuli in everyday life. In 2012, he created the Mood lounge and coffee tables for Manutti, as well as the Loop chair and various side tables. Two years later, Manutti received the 'Red Dot Award for Product Design' in the 'Gardens - Lounge Furniture' category for the Elements collection he designed in 2013. In 2014, he created the playful sofa concept Moon Island.

DESIGNER PORTRAIT

KOEN VAN EXTERGEM

Pure, sober and detailed style

Koen Van Extergem (1989) is a young Belgian designer with a pure, sober and detailed style, which he further refined during his studies in product development and furniture design. Van Extergem joined the Manutti design studio in 2013 and, together with Stephane De Winter, developed a new generation of lounge furniture in the shape of the Air collection. For 2018, he designed the Duo chair.

DESIGNER PORTRAIT

BRAM BOLLEN

Master of simplicity with an eye for detail

Bram Bollen (1979) started as a freelance designer in the outdoor furniture industry after obtaining a Master's Degree at the Media & Design Academy in Genk in 2004. Throughout the years, he has developed creative solutions for both professional and private customers. For Manutti, he designed the linear and timeless Liner collection in 2009-2010. Bollen finds inspiration in architecture and interior design. He is a master of simplicity and has a keen eye for detail, giving his designs a contemporary and refreshing feel.

DESIGNER PORTRAIT

MADS ODGÅRD

Keep it simple and the earth livable

The Danish designer Mads Odgård (1960) is a leading figure in a new generation of international designers. He is a minimalist and a 'less is more' man. With an educational background from The Royal Danish Academy of Fine Arts, Denmark's Design School and Art Center Europe, Switzerland, Odgård is one of Denmark's most sought-after designers. Since 1988, The Mads Odgård Design Studio has focused on product design with the mission to improve that which already exists and most importantly, gives the user spontaneous delight. According to Odgård, "design should be human and logical in form". Mads Odgård has won many prestigious awards including the German Design Council Award and Red Dot Germany.



DESERT

STONE

TO THE RIGHT COLOUR COMBINATION FOR EVERY SETTING

Our selection of 62 fabrics with 20 suggested colour combinations results in a wealth of possibilities for a breathtaking outdoor design. Are you contemplating if a pinch of Havana would match your favourite piece? We've laid it all out for you in 6 colour schemes, resolving any design enigma in the blink of an eye.

FOREST

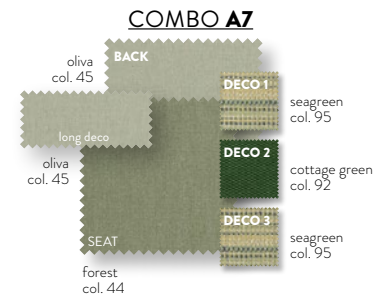
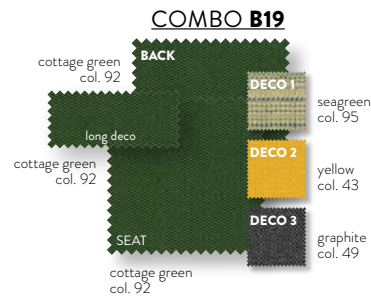



COMBO B20

BACK: nautic coal black col. 30N

DECO 1: cemento col. 03

DECO 2: storm col. 06

DECO 3: nautic coal black col. 30N

SEAT: nautic coal black col. 30N

long deco: nautic coal black col. 30N

COMBO B18

BACK: ice blue col. 36

DECO 1: soft white col. 12

DECO 2: cloud col. 53

DECO 3: ice blue col. 36

SEAT: ice blue col. 36

long deco: ice blue col. 36

COMBO B13

BACK: metallic col. 90

DECO 1: soft white col. 12

DECO 2: cloud col. 53

DECO 3: light petrol blue col. 14

SEAT: metallic col. 90

long deco: metallic col. 90

COMBO B17

BACK: smokey col. 27

DECO 1: soft white col. 12

DECO 2: azzure col. 96

DECO 3: pavone blue col. 97

SEAT: smokey col. 27

long deco: smokey col. 27

COMBO A8

BACK: soft white col. 12

DECO 1: vanilla col. 58

DECO 2: linen col. 59

DECO 3: soft white col. 12

SEAT: soft white col. 12

long deco: soft white col. 12

COMBO B12

BACK: sepia col. 04

DECO 1: azzure col. 96

DECO 2: pavone blue col. 97

DECO 3: sepia col. 04

SEAT: sepia col. 04

long deco: sepia col. 04

COMBO B9

BACK: graphite col. 49

DECO 1: cosmopolitan col. 51

DECO 2: cloud col. 53

DECO 3: cosmopolitan col. 51

SEAT: Milestone col. 40

long deco: graphite col. 49

COMBO B11

BACK: graphite col. 49

DECO 1: dune col. 57

DECO 2: lila col. 91

DECO 3: graphite col. 49

SEAT: graphite col. 49

long deco: graphite col. 49

COMBO A3

BACK: nautic textiles sand col. T11N

DECO 1: soft white col. 12

DECO 2: azzure col. 96

DECO 3: pavone blue col. 97

SEAT: nautic textiles sand col. T11N

long deco: nautic textiles sand col. T11N

COMBO B10

BACK: storm col. 06

DECO 1: abyss col. 08

DECO 2: light petrol blue col. 14

DECO 3: denim col. 46

SEAT: storm col. 06

long deco: storm col. 06

COMBO A6

BACK: abyss col. 08

DECO 1: sapphire col. 23

DECO 2: soft white col. 12

DECO 3: midnight col. 24

SEAT: abyss col. 08

long deco: abyss col. 08

ETNIC



MARINE



YOUR PARTNER FOR OUTDOOR PROJECTS

Every space demands a unique approach. Residential, hospitality or contract projects? Manutti develops customised solutions for every specific need and type of surroundings. Whatever market we're working for, our quality remains unsurpassed.

Love to see what we can do for you?
Discover a selection of Manutti projects
at www.manutti.com.



SPA, HOTELS, YACHTING,
HOSPITALITY,
PUBLIC BUILDINGS, ...









SELMAN HOTEL | MOROCCO • **JW MARRIOT** | ABSHERON BAKU - AZERBAIJAN
DUKE'S PALACE | BRUGES - BELGIUM • **GOLF CLUB THE NATIONAL** | STERREBEEK - BELGIUM
CASTEL BEAU SITE | PLOUMANACH - FRANCE • **PARKHOTEL VITZNAU** | SWITZERLAND
MARRIOT HOTEL | CONSTANTINE - ALGERIA • **HOTEL MANALI** | COURCHEVEL - FRANCE
ZECH HOTEL "SEVERINE'S RESORT" | SYLT • **HOTEL KILIMANDJARO** | COURCHEVEL - FRANCE
LA COQUILLADE | GARGAS - FRANCE • **HOTEL BEAU RIVAGE** | NICE - FRANCE
ANAHITA HOTEL | MAURITIUS • **TRIANON** | VERSAILLES - FRANCE • **W HOTEL PALM** | DUBAI
DOMAINE ROYAL PALM | MAURITIUS • **RADISSON BLUE** | NAIROBI - KENIA
HOTEL KEMPINSKY | PORTOROZ - SLOVENIA • **ROBERTO'S RESTAURANT** | DUBAI
HOTEL FINCA CORTESIN | MALAGA - SPAIN • **AFRICAN HOMESTEADS** | SOUTH AFRICA
CLOUDS ESTATE | STELLENBOSCH - SOUTH AFRICA • **ADDRESS FOUNTAIN VIEW HOTEL** | DUBAI
GLOBAL HOTEL ALLIANCE | SWITZERLAND • **THE AUGUSTINE PRAGUE** | CZECH REPUBLIC
RADISSON HOTEL | DURHAM - UNITED KINGDOM • **VILALARA HOTEL** | PORTUGAL
LE MERIDIEN | MONACO - FRANCE • **ONE HOTEL @PALM JUMEIRAH** | ABU DHABI
SPA SOFIEMYR | OSLO - NORWAY • **DOMAINE DE VERCHON** | FRANCE
VILLA EMILIA | BARCELONA - SPAIN • **RESTAURANT PUERTO CABON** | TENERIFE - SPAIN
SALES PAVILLON TERRACE | DUBAI CREEK HARBOUR • **MORALES** | TENERIFE - SPAIN
HOTEL PÈRE BISE | SEC SILVERA - FRANCE • **SILVER MUSE** | CRUISE • **VILLA AXEL ROCKS** | ST. BARTH
CORAL HOTEL | OMAN • **MUSCAT BAY SALE CENTRE** | OMAN • **KEMPINSKI MUSQAT, PRESIDENTIAL SUITES** | OMAN

MANUTTI STYLE	6
CONTRACT	18
MATERIALS & FABRICS	320
PROTECTION & MAINTENANCE	340
JOIN THE COMMUNITY	350

COLLECTIONS

FURNITURE	24	TABLES	214
Kumo	26	Minus	216
Elements	34	Torsa	217
Air	44	Air	218
San	54	Prato	219
Moon Island	60	Fuse	220
Kobo	66	Luna	221
Cascade	74	Trento	222
Duo	82	Quarto	223
Radius	88	Siena	224
Echo	94	Livorno	225
Loop	102	Milano	226
Zendo	108	Capri	227
Liner	118		
Squat	124	BISTRO TABLES	
Swing	130	Torsa	228
River	138	Napoli	229
Mood	146		
Solid	154	MULTIFIT TABLES	
Siena	160	Torsa	230
Cross teak	168	Mood tables	231
Cross alu	174	Outdoor side tables	232
Latona	178		
Fuse	184		
San Diego	192		
Malibu	200		
St-Tropez	206		
Versailles	210		

PRODUCTS

TYPE	236
Chairs	238
Lounge chairs	240
Sofas	242
Loungers	244
Low tables	246
Benches	247
Dining tables	248
Bar tables	250
Bar stools	251
Bistro tables	252
Outdoor rugs	253
Accessories	254
Trays	
Poufs	
Outdoor lighting & candles	
Rugs	
Trolleys	
Towel rack	
Umbrellas	256
Cushion boxes	257

TECHNICAL SPECIFICATIONS

FURNITURE	258	TABLES	296
Kumo	260	Minus	298
Elements	262	Torsa	299
Air	264	Air	300
San	266	Prato	301
Moon Island	268	Fuse	302
Kobo	270	Luna	303
Cascade	271	Trento	304
Duo	272	Quarto	305
Radius	273	Siena	306
Echo	274	Livorno	307
Loop	275	Milano	308
Zendo	276	Capri	309
Liner	279		
Squat	280	BISTRO TABLES	
Swing	282	Torsa	299
River	283	Napoli	310
Mood	284		
Solid	285	MULTIFIT TABLES	
Siena	286	Torsa	299
Cross teak	288	Mood tables	311
Cross alu	288	Outdoor side tables	312
Latona	289		
Fuse	290	ACCESSORIES	
San Diego	292	Trays	313
Malibu	294	Towel rack	313
St-Tropez	295	Poufs	314
Versailles	295	Outdoor lighting & candles	315
		Umbrellas	316
		Rugs	318
		Cusion boxes	319



Collections Furniture

Designed and
crafted for
better outdoor
moments









Kumo concept 5 white F8
Mood lounge table ø100 white F8 + CEW
Mood lounge table ø80 white F8 + CEW
Mood coffee table ø60 white F8 + CEW
Touch Pouf ø82
Touch Pouf ø52
Torsa dining table teak + CEMW
Solid chair teak

Kumo Concept 6 modified white F8
Outdoor sidetable open white F8
Prato dining table white F8 + aged teak
Prato bench white F8 + aged teak
Echo chair white F8 + silver R2
Kumo Concept 4 white F8
Twilight F8
Flame small, medium & large white F8







Kumo Concept 3 lava F10
Kumo pouf 50
Flame small lava F10
Tray 48x48 lava F10



Kumo pouf 50



Kumo concept 4 lava F10
Kumo pouf 50
Outdoor sidetable open lava F10
Vital (set of 3) lava F10
Moon Island lounge table / footstool ø104
Moon Island pouf ø63



Kumo concept 2 lava F10
Kumo concept 6 lava F10
Air dining table lava F10 + iroko
Echo chair lava F10 + bronze R1
Prato coffee table lava F10 + GLB
Twilight lava F10
Flame small, medium & large lava F10



Kumo custom concept lava F10
Vital (set of 2) lava F10
Vital (set of 3+2) lava F10





Echo chair F8 + Air table F8
Elements Concept 4
Kumo pouf 50
Vital (set of 3) white F8



Elements Concept 1 casual
Elements sidetable
Moon Island footstool/sidetable ø104



Elements Concept 6 casual
Elements custom concept
Vital (set of 2) white F8



Elements Concept 5 regular
Rug Steps silver M480



Elements Concept 6 regular
Elements footrest 70



Elements Concept 6 regular
Elements sidetable

Double Elements Concept 6 regular
Elements footrest 70
Tray 60x28 lava F10





Elements Concept 3 regular modified
Tray 48x48 lava F10



Elements custom concept
Elements sidetable white F8
Small central pole umbrella 180x180 black F7
Iron base 21 kg

AIR

designed by
KOEN VAN EXTERGEM





Air Concept 1 white F8 + iroko
Outdoor sidetable closed white F8
Quarto dining table white F8 + teak
Cross chair alu white F8 + white T8
Tray 48x48 white F8

Air Concept 3 white F8 + iroko





Air Concept 6 white F8 + iroko
Outdoor sidetable closed white F8
Outdoor sidetable round white F8



Air custom concept white F8 + iroko
Echo chair white F8 + silver R2
Air dining table white F8 + iroko
Twilight white F8





Air Concept 6 lava F10
Touch Pouf ø52





Air Concept 4 lava F10
Twilight lava F10
Touch Pouf ø82
Minus dining table lava F10 + CEF
Radius chair lava F10 + bronze R1



Air Concept 1 lava F10 + iroko
Air large footstool/sidetable lava F10
Outdoor sidetable closed lava F10



Air Concept 6 lava F10
Tray 60x28 lava F10

SAN

designed by
LIONEL DOYEN







San bench
Marble round 40





San Sofa
San 1 seater
Mood 1s lava F10 hazel 44
Mood lounge table ø100 lava F10 + iroko
San lounge
Flame medium & large lava F10
Twilight lava F10
Marble round 40 CEMB
Marble rectangular 60 CEMB





San sofa
Marble round 40 CEMB



San bench
Echo 1S lava F10 + anthracite R3

MOON ISLAND

designed by
GERD COUCKHUYT





Moon Island Concept 2 nautic leather white 33
Napoli bistro table white F8 + GLW



Moon island Concept 2 textiles sand T11
Moon island pouf ø52 textiles sand T11
Moon island pouf ø63 textiles sand T11

Moon island Concept 1 nautic leather white 33
Moon island pouf ø52 nautic leather white 33
Moon island pouf ø63 nautic leather white 33
Twilight white F8



Moon island Concept 1 nautic leather white 33





Moon island Concept 1 custom finish
Kumo pouf 50
Moon island pouf ø52 custom finish
Moon island footstool/sidetable 104 custom finish
Outdoor sidetable round lava F10



KOBO
designed by
MANUTTI DESIGN STUDIO



Kobo 1S pepper R4
Kobo 3S pepper R4
Torsa coffee table teak + CEF
Touch Pouf 112x65
Touch Pouf ø82
Touch Pouf ø52
Flame small, medium & large white F8
Linear pepper Rug





Kobo 1S anthracite R3
Kobo 3S anthracite R3
Torsa coffee table teak nero TN + CET
Torsa coffee table teak T + CET
Linear pepper Rug





Kobo 1S anthracite R3
Torsa coffee table teak nero TN + CEMB
Torsa bistro table teak T + CEMB
Solid chair teak T
Flame small & medium white F8
Touch Pouf 112x65
Touch Pouf ø82
Touch Pouf ø52
Rug Twist silver Rug
Rug Twist bronze Rug



Kobo 1S pepper R4





Kobo 1S pepper R4
Kobo 3S pepper R4
Torsa coffee table teak T ø148 + CEF
Torsa coffee table teak T ø100 + CEF
Touch Pouf 112x65
Touch Pouf ø82
Touch Pouf ø52
Flame small & medium white F8

CASCADE

designed by
MANUTTI DESIGN STUDIO



Cascade daybed white F8 +silver R2





Cascade daybed white F8 + silver R2
Flame small white F8





Cascade 3S white F8 + silver R2
 Echo 1S white F8 + silver R2
 Quarto table white F8 + CEL

Cascade 3S white F8 + silver R2
 Cascade 1S white F8 + silver R2
 Mood lounge table ø100 white F8 + iroko
 Outdoor sidetable round white F8
 Flame medium & large white F8

Cascade 1S lava F10 + anthracite R3
Cascade 3S lava F10 + anthracite R3
Prato coffee table lava F10 + GLS
Trento dining table lava F10 + CEQ
Echo chair lava F10 + anthracite R3





Cascade 1S lava F10 + anthracite R3





Cascade 1S lava F10 + anthracite R3
Mood coffee table ø42 lava F10 + GLS

Cascade 1S lava F10 + anthracite R3
Cascade 3S lava F10 + anthracite R3
Mood coffee table ø42 lava F10 + GLS
Outdoor sidetable round lava F10





Duo chair flint F13 + pepper R4
Minus table flint F13 + CEF



Duo chair lava F10 + anthracite R3
Torsa table teak nero + CEK
Duo rocking chair F10 + anthracite R3





Duo chair lava F10 + anthracite R3
Minus table lava F10 + CET
Duo rocking chair lava F10 + anthracite R3



Duo rocking chair lava F10

RADIUS
designed by
MANUTTI DESIGN STUDIO





Air dining table lava F10 + CET
Radius chair lava F10 + bronze R1





Radius chair lava F10 + silver R2

Radius chair lava F10 + silver R2
Torsa dining table teak T + CEF



Radius chair lava F10 + silver R2
Torsa bistro table teak nero TN + CEK



Minus dining table lava F10 + CEF
Radius chair lava F10 + silver R2
Twist Rug
Kobo 3S pepper R4





Quarto dining table lava F10 + CEQ
Echo chair lava F10 + bronze R1



Fuse dining table lava F10 + teak
Echo chair lava F10 + bronze R1
Flame small, medium & large lava F10

Echo 1s lava F10 + anthracite R3
Flame small, medium & large lava F10





Napoli bistro table white F8 + teak
Echo chair white F8 + silver R2
Kumo Concept white F8



Prato dining table white F8 + GLW
Echo chair white F8 + silver R2
Latona lounge white F8 + white T8

Trento dining table white F8 + GLS
Echo chair white F8 + silver R2
Cascade 1s white F8 + silver R2
Outdoor sidetable open white F8





LOOP
designed by
GERD COUCKHUYT



Loop dining chair lava F10 + sparrow 28
Loop chair lava F10 + sparrow 28
Minus dining table lava F10 + CET



Loop dining chair lava F10 + sparrow 28
Loop chair lava F10 + sparrow 28
Minus dining table lava F10 nero + CET





Loop dining chair lava F10 + Milestone 40
Flame medium & large lava F10



Loop chair white F8 + smokey 27
Air dining table white F8 + CEW



Elements Concept 6 regular
Loop chair + dining chair white F8 + smokey 27
Air dining table white F8 + CEW



ZENDO
designed by
MANUTTI DESIGN STUDIO





Zendo custom concept lava F10 + sparrow 28
Zendo large & small footstool lava F10 + sparrow 28
Zendo lounge lava F10 + sparrow 28
Small central pole umbrella black T7



Zendo custom concept lava F10 + sparrow 28
Echo 1S lava + bronze R1
Outdoor sidetable round lava F10
Twilight lava F10





Zendo custom concept white F8 + smokey 27
Luna dining table white F8 + CEW
Zendo chair white F8 + smokey 27



Zendo lounge white F8 + smokey 27
Small central pole umbrella white F8
Mood coffee table ø42 white F8 + GLW



Zendo concept 1 white F8 + smokey 27
Zendo small footstool white F8 + smokey 27



Luna dining table white F8 + CEW
Zendo chair white F8 + smokey 27

Zendo custom concept white F8 + nautic leather white 33
Mood lounge table ø100 white F8 + GLW
Mood lounge table ø80 white F8 + TRW
Mood coffee table ø42 white F8 + GLW
Outdoor sidetable open white F8





Zendo chair white F8 + nautic leather white 33
Quarto dining table white F8 + GLW



LINER

designed by
BRAM BOLLEN



Zendo 2S white F8 + smokey 27
Liner 1S white F8 + smokey 27
Prato coffee table white F8 + GLW
Steps silver Rug
Twilight white F8
Flame medium & large white F8
Air dining table white + CEW
Loop chair white F8 + smokey 27



Liner 1s white F8 + smokey 27
Twilight white F8



Luna dining table white F8 + GLW
Liner chair white F8 + nautic leather white 33
Liner lounge white F8 + nautic leather white 33
Outdoor sidetable open white F8



Liner lounge white F8 + nautic leather white 33
Aluminium umbrella 300x300



Trento dining table lava F10 + GLT
Liner chair lava F10 + sparrow 28



Liner lounge lava F10 + sparrow 28
Flame small & large lava F10

SQUAT
designed by
MANUTTI DESIGN STUDIO





Squat Concept 4 lava F10 + Taupegrey 79N
Prato coffee table lava F10 + GLT
Steps silver Rug



Squat 1s lava F10 + Taupegrey 79N
Outdoor sidetable round lava F10



Squat custom concept lava F10 + Taupegrey 79N
Outdoor sidetable round lava F10
Loop chair lava F10 + sparrow 28

Squat custom concept lava F10 + Taupegrey 79N
Mood 1S lava F10 + hazel 44
Fuse lounge lava F10
Quarto coffee table lava F10 + teak
Flame large lava F10
Mood coffee table ø80 lava F10 + teak





Squat custom concept lava F10 + Taupegrey 79N
Quarto coffee table lava F10 + teak
Tray 60x28 lava F10

SWING

designed by
MANUTTI DESIGN STUDIO



Swing 1s off white 31
Swing medium footstool off white 31



Swing chair off white 31
Fuse dining table white F8 + GLW
Swing lounge off white 31





Swing lounger hazel 44
Swing 1S hazel 44
Swing chair hazel 44
Quarto coffee table lava F10 + CEQ
Steps aqua Rug

Swing chair seashell 26
Prato dining table lava F10 + aged teak



Swing chair hazel 44
Torsa dining table teak + CMB



Swing chair hazel 44
Torsa dining table teak + CMB
Touch Pouf 112x65
Touch Pouf ø82
Touch Pouf ø52





Swing 1S hazel 44
Swing medium footstool hazel 44
Swing small footstool hazel 44



Swing lounge seashell 26

RIVER

designed by
MANUTTI DESIGN STUDIO





River 3S old grey 84
River 1S old grey 84
Siena coffee table
Prato bench lava F10 + aged teak
Flame small, medium & large lava F10
River small sunbed old grey 84



River 1S old grey 84
River small sunbed old grey 84
Small central pole umbrella white F8
Mood lounge table ø80 white F8 + GLS

River small sunbed old grey 84
River large sunbed old grey 84





River 3S old grey 84
Siena sidetable
Siena coffee table



River 3S old grey 84
River 1S old grey 84
Siena sidetable
Siena coffee table
Flame large lava F10





Cross chair white F8 textiles T8
River 3S old grey 84
River 1S old grey 84
Quarto coffee table white F8 + CEW
Outdoor sidetable round white F8
Flame small, medium & large white F8



River 1S old grey 84
Flame small & medium lava F10
Mood coffee table ø42 lava F10 + iroko

MOOD

designed by
MANUTTI DESIGN STUDIO



Swing lounger off white 1
Mood coffee table ø42 white F8 + iroko
Flame small, medium & large white F8
Trento dining table white F8 + teak
Mood chair white F8 + seashell 26





Mood chair white F8 + off white 31
Prato dining table white F8 + GLW



Mood barstool white F8 + off white 31
Napoli bartable white F8 + TRW
Mood 1S white F8 + off white 31





Mood chair lava F10 + hazel 44
Quarto dining table lava F10 + GLS

Mood chair lava F10 + hazel 44
Quarto dining table lava F10 + GLS
Zendo custom concept lava F10 + sparrow 28



Mood 1S lava F10 + hazel 44



Mood chair lava F10 + hazel 44
Air dining table lava F10 + iroko
Flame medium lava F10



SOLID

designed by
LIONEL DOYEN





Solid chair teak
Torsa dining table ø148 teak + CMW



Solid chair teak



Solid chair teak nero





Solid chair teak nero
Torsa dining table teak nero + CEMB



Solid chair teak
Torsa dining table teak + CEF



Solid chair teak + seat & back cushion
Torsa bistro table teak + CEMW

SIENA
designed by
MANUTTI DESIGN STUDIO





Siena lounge teak
Siena towel rack
Siena chair teak
Siena dining table
Siena custom concept
Flame small & large lava F10



Siena lounge teak
Siena custom concept
Mood lounge table ø80 lava F10 + iroko
Siena dining table
Siena chair teak



Siena lounge teak
Mood lounge table ø80 lava F10 + iroko



Siena custom concept



Siena cushion box
Siena 1S
Siena custom concept
Teak umbrella ø300

Siena textiles lounge black T4
Siena custom concept
Teak umbrella 300x400
Siena dining table
Siena textiles chair black T4



Siena textiles lounge black T4





CROSS

designed by
MADS ODGÅRD





Cross teak chair black T4
Torsa bistro table teak + CEMW
Flame small & medium lava F10



San bench
Cross teak chair custom fabric
Small central pole custom finish
Torsa bistro table teak + CET



Cross teak chair black T4
Cross teak chair custom fabric
Touch Pouf ø82



Siena lounge teak
teak umbrella 350x350
Cross teak chair bronze T3
Siena dining table





Livorno dining table + Teak top
Cross teak chair ecru T12



Quarto dining table white F8 + CEW
Cross chair white F8 + white T8
Flame small & medium white F8
River 1S old grey 84
River 3S old grey 84
Mood lounge table ø100 lava F10 + CEW



Cross chair white F8 + white T8



Cross chair lava F10 + black T7
Prato dining table lava F10 + aged teak
Prato bench lava F10 + aged teak



Cross chair lava F10 + black T7



Cross chair white F8 + white T8
Quarto dining table white F8 + teak



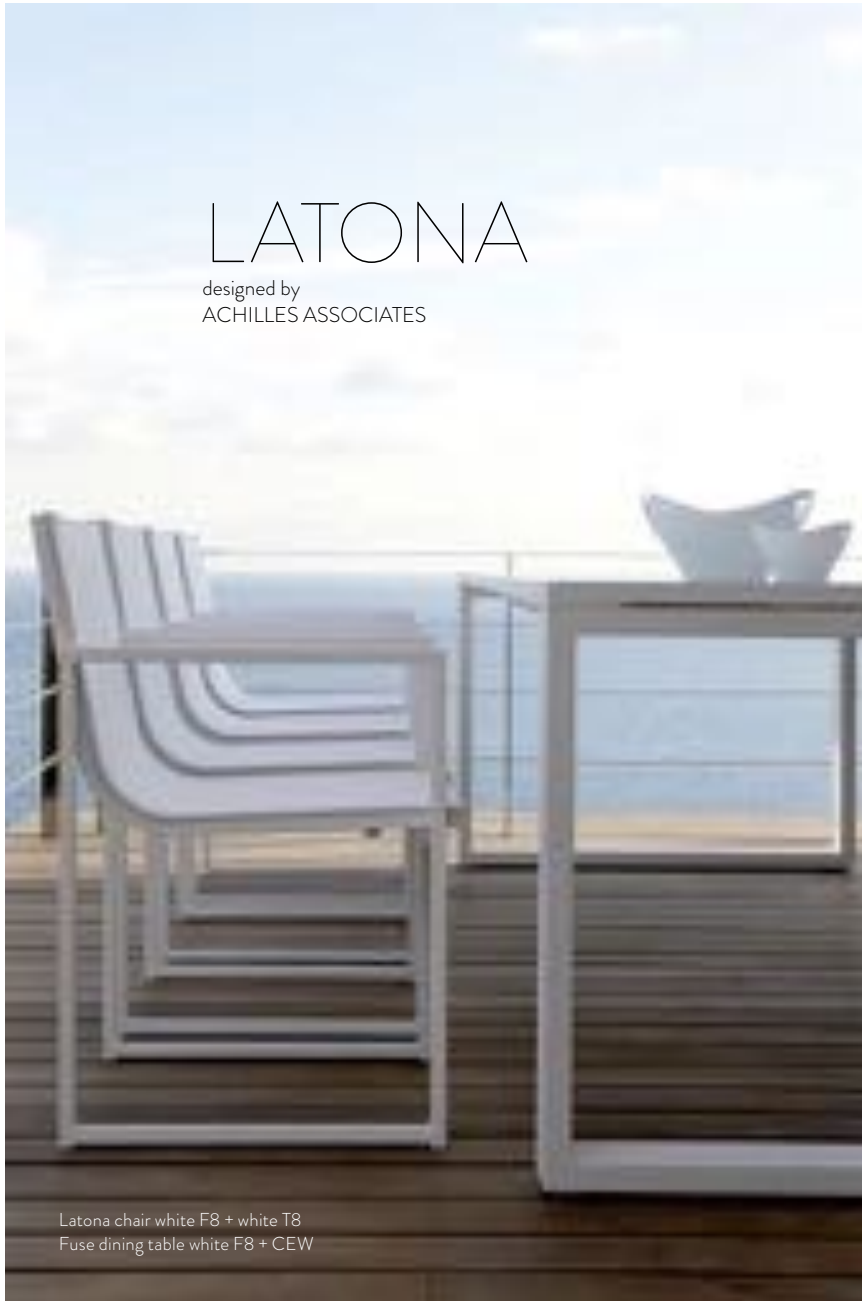

Zendo custom concept white F8 + nautic leather white 33
Fuse bench 300cm white F8
Fuse bench 45cm white F8
Fuse dining table white F8 + CEW
Latona chair white F8 + white T8





Latona (Helios) barstool white F8 + white T8
Quarto bartable white F8 + CEW



Latona (Helios) lounge white F8 + white T8



Latona chair lava F10 + mocca T10
Napoli bistro table lava F10 + TRB





Latona chair lava F10 + black T7
Napoli bistro table lava F10 + TRB

FUSE

designed by
MANUTTI DESIGN STUDIO





Fuse lounge white F8 + white T8
Fuse sidetable white F8
Fuse dining table white F8 + GLW
Fuse bench 300cm white F8
Fuse cushion box white F8
Fuse custom concept white F8 + white T8
Fuse bench 45 + white F8



Fuse lounge white F8 + white T8
Small central pole umbrella white F8



Latona chair white F8 + white T8
Fuse custom concept white F8
Small central pole umbrella white F8
Iron base 21 kg white F8



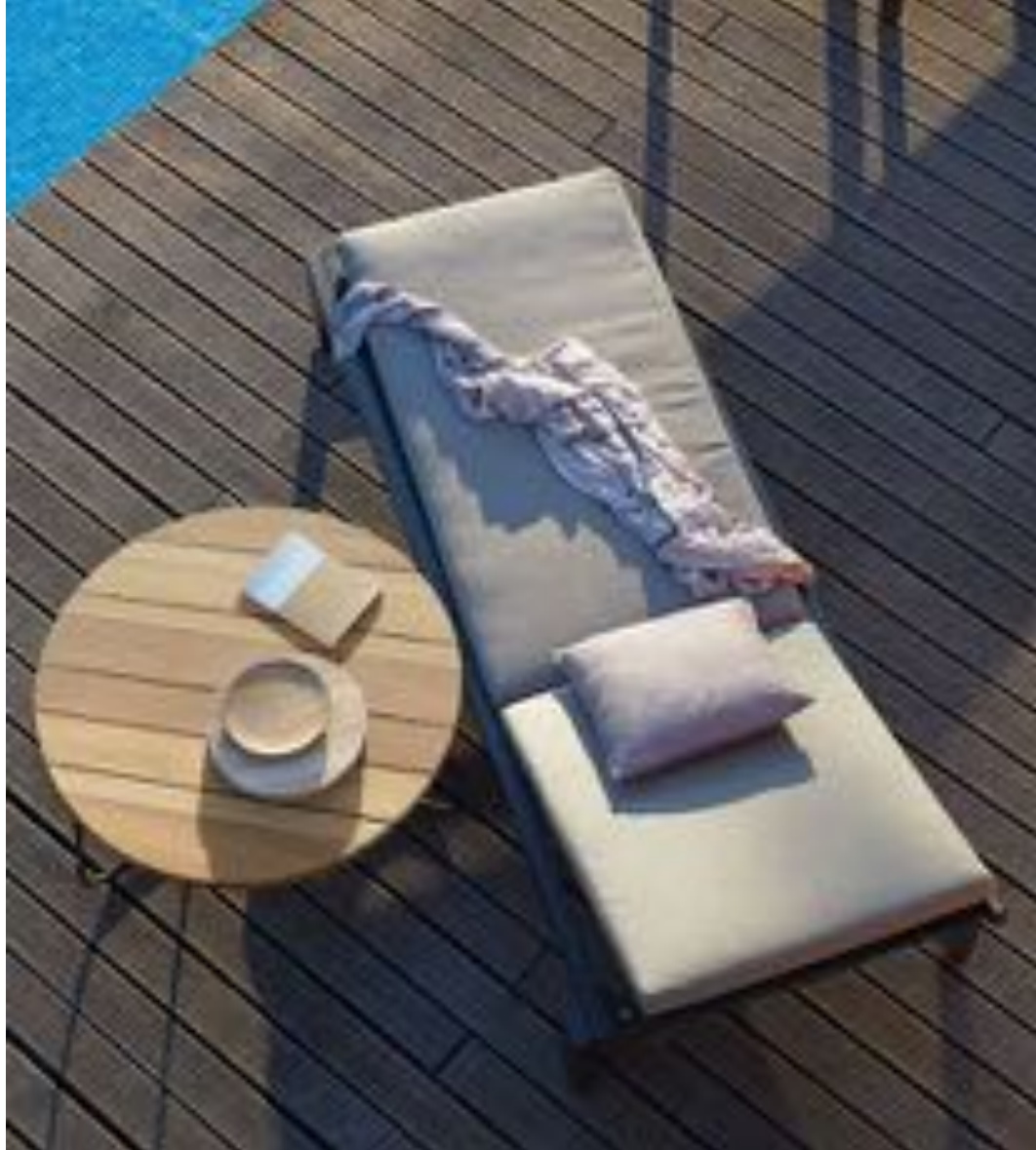

Fuse lounge lava F10 + black T7
Mood coffee table ø80 lava F10 + iroko





Fuse lounge lava F10 + black T7
Outdoor sidetable closed lava F10
Fuse custom concept lava F10 + black T7
Prato coffee table lava F10 + aged teak
Flame small & medium lava F10



Fuse bench 300cm white F8



Fuse dining table white F8 + GLW
Fuse bench 45cm white F8



Outdoor sidetable round white F8
Small central pole umbrella white F8
Fuse lounge white F8 + white T8
Fuse large footstool white F8
Fuse medium footstool white F8
Fuse sidetable white T8

SAN DIEGO

designed by
MANUTTI DESIGN STUDIO



San Diego Concept 2 - old grey 84
Flame small, medium & large flame F10
Twist bronze Rug



San Diego lounge old grey 84
San Diego small footstool old grey 84
Small central pole umbrella black T7





San Diego lounge old grey 84
San Diego small footstool old grey 84



San Diego chair old grey 84
Siena dining table



San diego chair old grey 84
Livorno dining table



San Diego round chair old grey 84





San Diego Concept 3 old grey 84



San Diego wing chair old grey 84
San Diego medium footstool old grey 84



MALIBU

designed by
MANUTTI DESIGN STUDIO

Malibu 2.5S camel 23

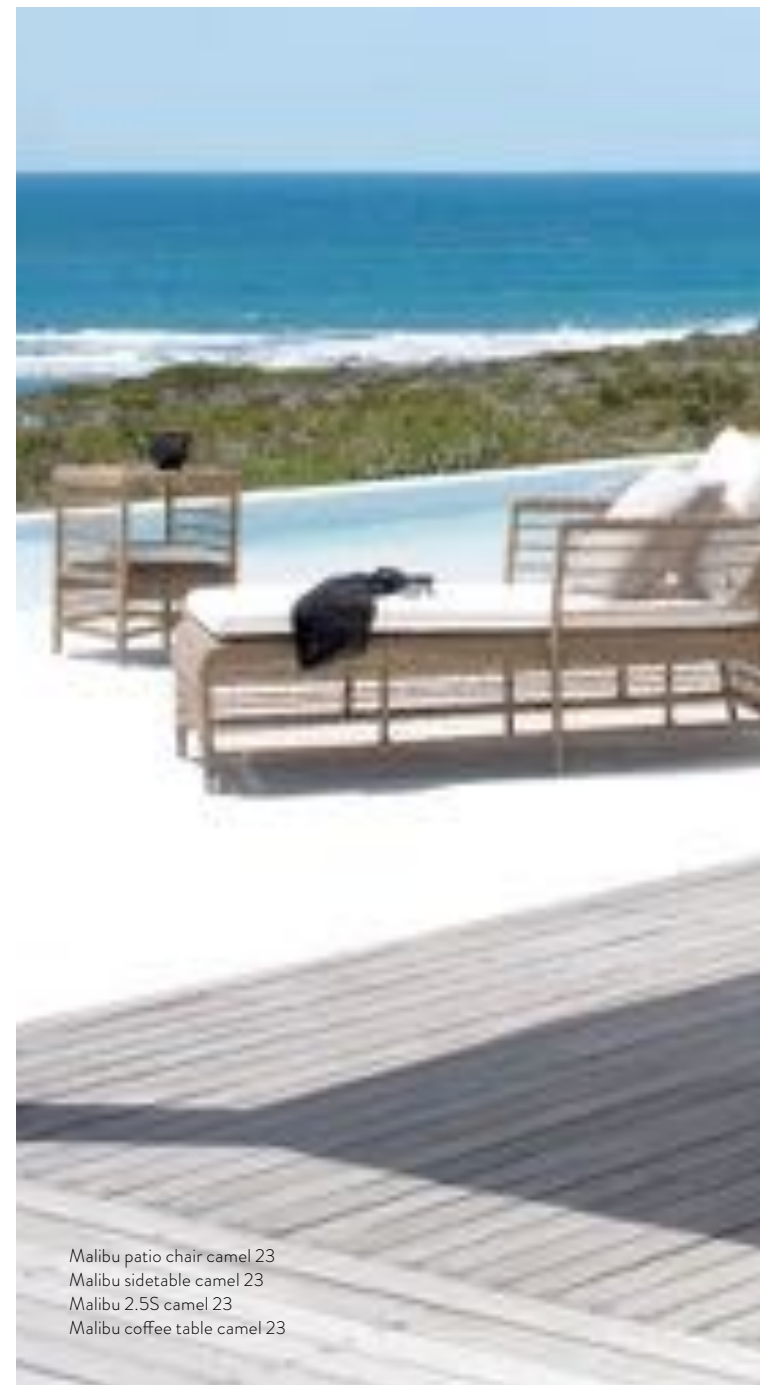

Malibu patio chair camel 23
Malibu sidetable camel 23
Malibu 2.5S camel 23
Malibu coffee table camel 23







Malibu 2.5S camel 23
Malibu 1S camel 23
Malibu sidetable camel 23
Malibu coffee table camel 23
Malibu patio chair camel 23

Malibu patio chair camel 23
Malibu 1S camel 23
Malibu medium footstool camel 23



Livorno dining table teak + stone insert
Malibu chair camel 23



Malibu square sidetable camel 23



Malibu chair camel 23

ST-TROPEZ

designed by
MANUTTI DESIGN STUDIO





St Tropez chair anthracite 89
St Tropez dining chair anthracite 89
Capri dining table anthracite teak



St Tropez chair anthracite 89
Capri dining table anthracite 89 + stone top



St Tropez chair anthracite 89
St Tropez dining chair anthracite 89
Capri dining table anthracite 89 teak + stone insert





Versailles chair white F8
Capri dining table white F8 + teak top
Teak umbrella 350x350



Versailles chair anthracite 89
Capri dining table anthracite 89 + stone top

Versailles chair anthracite 89



Collections Tables

Shaped for
long-lasting
comfort





MINUS
DINING TABLES



Duo chair flint F13 + pepper R4
Minus dining table flint F13 + CET



Duo chair lava F10 + anthracite R3
Minus dining table lava F10 + CEF





Solid chair teak
Torsa dining table teak T + CEMW



Radius chair lava F10 + silver R2
Torsa dining table teak T + CEF

TORSA
DINING TABLES



Solid chair lava F10 + anthracite R3
Torsa dining table teak nero TN + CEK

AIR
TABLES



Air dining table lava F10 + CEQ
Loop chair lava F10 + sparrow 28



Air dining table white F8 + iroko
Echo chair white F8 + silver R2



Air dining table lava F10 + Iroko
Echo chair lava F10 + bronze R1



Prato dining table white F8 + aged teak
 Prato bench white F8 + aged teak
 Latona (Helios) lounge white F8 + white T8
 Teak umbrella ø300



Prato coffee table lava F10 + GLB
 Cascade 1S + 3S lava F10 + anthracite R3
 Echo 1S lava F10 + anthracite R3

PRATO

TABLES



Prato dining table white F8 + GLW
 Echo chair white F8 + silver R2

Fuse dining table lava F10 + GLB
 Fuse bench 300cm lava F10
 Fuse bench 45cm lava F10
 Latona chair lava F10 + black T7



Fuse dining table white F8 + teak
 Echo chair white F8 + silver R2



FUSE

TABLES

Fuse dining table white F8 + CEW
 Fuse bench 300cm white F8



LUNA

TABLES

Extendable: see p. 120

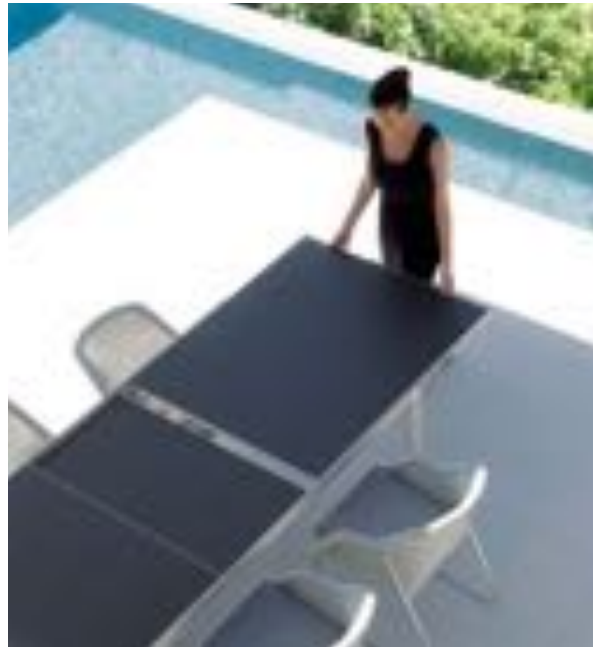

TRENTO

TABLES



Trento dining table lava F10 + GLB
Cascade 1S lava F10 + anthracite R3
Echo chair lava F10 + anthracite R3



Cascade Daybed white F8 + silver R2
Cascade 3S white F8 + silver R2
Cascade 1S white F8 + silver R2
Trento coffee table white F8 + CEL



Trento dining table white F8 + CEW
Mood chair white F8 + off white 31

QUARTO

TABLES



Quarto dining table white F8 + CEW
Echo chair white F8 + silver R2
Twilight white F8



Quarto bartable white F8 + TRW
Latona (Helios) barstool white F8 + white T8

SIENA
TABLES



Siena dining table teak
Siena chair teak



Siena coffee table teak
River 3S old grey 84
River 1S old grey 84
Flame large lava F10



Siena dining table teak
Mood chair lava F10 + hazel 44





Livorno dining table teak
Cross chair teak + ecru T12



Livorno dining table teak + stone insert
Malibu chair camel 23

LIVORNO

TABLES



Livorno dining table teak + stone insert
San Diego chair old grey 84

MILANO

TABLES



Milano extendible table teak
Cross chair teak + textiles ecru T12



CAPRI

TABLES



Capri dining table anthracite 89 + teak and stone insert
 St Tropez dining chair anthracite 89
 St Tropez chair anthracite 89



Capri dining table white F8 + top aged teak
 Versailles chair white F8



Solid chair teak nero
Torsa bistro table teak nero TN + CEK



Torsa bistro table teak T + CEF
Cross chair teak custom finish
Small central pole umbrella custom finish
San bench



TORSA
BISTRO TABLES



Radius chair lava F10 + silver R2
Torsa bistro table teak nero TN + CEMB



NAPOLI

BISTRO TABLES



TORSA
MULTIFIT COFFEE TABLES



MOOD
MULTIFIT COFFEE TABLES





CLOSED OUTDOOR SIDETABLES

MULTIFIT



OPEN OUTDOOR SIDETABLES

MULTIFIT





ROUND OUTDOOR SIDETABLES

MULTIFIT



VITRAL OUTDOOR SIDETABLES

MULTIFIT



Products overview

Our collections
ordered by type





CHAIRS

LOUNGE CHAIRS

SOFAS

LOUNGERS

LOW TABLES

BENCHES

DINING TABLES

BAR TABLES

BAR STOOLS

BISTRO TABLES

OUTDOOR RUGS

ACCESSORIES

UMBRELLAS

CUSHION BOXES



DUO Inspiration p. 82

Available colours



Tech.info:

p. 272



RADIUS Inspiration p. 88

Available colour combinations



Tech.info:

p. 273



ECHO Inspiration p. 94

Available colour combinations

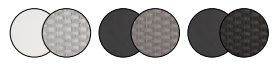

Tech.info:

p. 274



LOOP Inspiration p. 102

Available colour combinations



Tech.info:

p. 275



ZENDO Inspiration p. 108

Available colour combinations

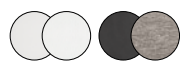

Tech.info:

p. 276



LINER Inspiration p. 118

Available colour combinations



Tech.info:

p. 279



SWING

Inspiration p. 130

Available colours



Tech.info:

p. 282



MOOD

Inspiration p. 146

Available colour combinations



Tech.info:

p. 284



SOLID

Inspiration p. 154

Available colours



Tech.info:

p. 285



SIENA

Inspiration p. 160

Available colour combinations



Tech.info:

p. 286



CROSS TEAK

Inspiration p. 168

Available colour combinations



+ 5 more

Tech.info:

p. 288



CROSS

Inspiration p. 174

Available colour combinations



Tech.info:

p. 288



LATONA

Inspiration p. 178

Available colour combinations



Tech.info:

p. 289



SAN DIEGO

Inspiration p. 192

Available colour



Tech.info:

p. 292



MALIBU

Inspiration p. 200

Available colour



Tech.info:

p. 294



ST-TROPEZ

Inspiration p. 206

Available colour



Tech.info:

p. 295



VERSAILLES

Inspiration p. 210

Available colours



Tech.info:

p. 295

LOUNGE CHAIRS

SOFAS

LOUNGERS

LOW TABLES

BENCHES

DINING TABLES

BAR TABLES

BAR STOOLS

BISTRO TABLES

OUTDOOR RUGS

ACCESSORIES

UMBRELLAS

CUSHION BOXES



KOBO

Inspiration p. 66

Available colours



Tech.info:

p. 270



ECHO

Inspiration p. 94

Available colour combinations



Tech.info:

p. 274



LINER

Inspiration p. 118

Available colour combinations



Tech.info:

p. 279



CASCADE

Inspiration p. 74

Available colour combinations



Tech.info:

p. 271



ZENDO

Inspiration p. 108

Available colour combinations



Tech.info:

p. 276



SQUAT

Inspiration p. 124

Available colour combination



Tech.info:

p. 280



SWING

Inspiration p. 130

Available colours

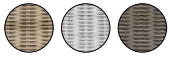

Tech.info:

p. 282



RIVER

Inspiration p. 138

Available colour



Tech.info:

p. 283



MOOD

Inspiration p. 146

Available colour combinations



Tech.info:

p. 284



SIENA

Inspiration p. 160

Available colour combinations



Tech.info:

p. 286



FUSE

Inspiration p. 184

Available colour combinations



Tech.info:

p. 290



SAN DIEGO

Inspiration p. 192

Available colour



Tech.info:

p. 292



MALIBU

Inspiration p. 200

Available colour



Tech.info:

p. 294

CHAIRS

LOUNGE CHAIRS

SOFAS

LOUNGERS

LOW TABLES

BENCHES

DINING TABLES

BAR TABLES

BAR STOOLS

BISTRO TABLES

OUTDOOR RUGS

ACCESSORIES

UMBRELLAS

CUSHION BOXES



KUMO

Inspiration p. 26

Available frame colours



Tech.info:

p. 260



ELEMENTS

Inspiration p. 34

Available colour combination



Tech.info:

p. 262



AIR

Inspiration p. 44

Available colour combinations



Tech.info:

p. 264



SAN

Inspiration p. 54

Available colour combination



Tech.info:

p. 266



MOON ISLAND

Inspiration p. 60

Available colours



Tech.info:

p. 268



KOBO

Inspiration p. 66

Available colours



Tech.info:

p. 270



CASCADE

Inspiration p. 74

Available colour combinations



Tech.info:

p. 271



ZENDO

Inspiration p. 108

Available colour combinations



Tech.info:

p. 276



SQUAT

Inspiration p. 124

Available colour combinations



Tech.info:

p. 280



RIVER

Inspiration p. 138

Available colour



Tech.info:

p. 283



SIENA

Inspiration p. 160

Available colour combinations



Tech.info:

p. 286



FUZE

Inspiration p. 184

Available colour combinations



Tech.info:

p. 290



SAN DIEGO

Inspiration p. 192

Available colour



Tech.info:

p. 292



MALIBU

Inspiration p. 200

Available colour



Tech.info:

p. 294

CHAIRS

LOUNGE CHAIRS

SOFAS

LOUNGERS

LOW TABLES

BENCHES

DINING TABLES

BAR TABLES

BAR STOOLS

BISTRO TABLES

OUTDOOR RUGS

ACCESSORIES

UMBRELLAS

CUSHION BOXES



KUMO

Inspiration p. 26

Available frame colours



Tech.info:

p. 260



ELEMENTS

Inspiration p. 34

Available colour combination



Tech.info:

p. 262



AIR

Inspiration p. 44

Available colour combinations



Tech.info:

p. 264



SAN

Inspiration p. 54

Available colour combination



Tech.info:

p. 266



CASCADE

Inspiration p. 74

Available colour combinations



Tech.info:

p. 271



ZENDO

Inspiration p. 108

Available colour combinations



Tech.info:

p. 276

+ optional combinations



LINER

Inspiration p. 118

Available colour combinations



Tech.info:

p. 279



SWING

Inspiration p. 130

Available colours



Tech.info:

p. 282



RIVER

Inspiration p. 138

Available colour



Tech.info:

p. 283



SIENA

Inspiration p. 160

Available colour combinations



Tech.info:

p. 286



LATONA

Inspiration p. 178

Available colour combinations



Tech.info:

p. 289



FUSE

Inspiration p. 184

Available colour combinations



Tech.info:

p. 290



SAN DIEGO

Inspiration p. 192

Available colour



Tech.info:

p. 292



MALIBU

Inspiration p. 200

Available colour



Tech.info:

p. 294

CHAIRS
LOUNGE CHAIRS
SOFAS
LOUNGERS

LOW TABLES

BENCHES
DINING TABLES
BAR TABLES
BAR STOOLS
BISTRO TABLES
OUTDOOR RUGS
ACCESSORIES
UMBRELLAS
CUSHION BOXES



MOOD

Inspiration p. 231

Available frame colours



Tech.info:

p. 311



TORSIA

Inspiration p. 217

Available frame colours



Tech.info:

p. 299



PRATO

Inspiration p. 219

Available frame colours



Tech.info:

p. 301



TRENTO

Inspiration p. 222

Available frame colours



Tech.info:

p. 304



QUARTO

Inspiration p. 223

Available frame colours



Tech.info:

p. 305



SIENA

Inspiration p. 224

Available frame colour



Tech.info:

p. 306

CHAIRS
 LOUNGE CHAIRS
 SOFAS
 LOUNGERS
 LOW TABLES
BENCHES
 DINING TABLES
 BAR TABLES
 BAR STOOLS
 BISTRO TABLES
 OUTDOOR RUGS
 ACCESSORIES
 UMBRELLAS
 CUSHION BOXES



SAN

Inspiration p. 54

Available colour combination



Tech.info:

p. 266



PRATO

Inspiration p. 219

Available colour combinations



Tech.info:

p. 301



FUSE

Inspiration p. 184

Available frame colours



Tech.info:

p. 290



TRENTO

Inspiration p. 222

Available frame colours



Tech.info:

p. 304

CHAIRS
LOUNGE CHAIRS
SOFAS
LOUNGERS
LOW TABLES
BENCHES

DINING TABLES

BAR TABLES
BAR STOOLS
BISTRO TABLES
OUTDOOR RUGS
ACCESSORIES
UMBRELLAS
CUSHION BOXES



MINUS

Inspiration p. 216

Available frame colours



Tech.info:

p. 298



TORSA

Inspiration p. 217

Available frame colours



Tech.info:

p. 299



AIR

Inspiration p. 218

Available frame colours



Tech.info:

p. 300



PRATO

Inspiration p. 219

Available frame colours



Tech.info:

p. 301



FUSE

Inspiration p. 220

Available frame colours



Tech.info:

p. 302



LUNA

Inspiration p. 221

Available frame colours



Tech.info:

p. 303



TRENTO

Inspiration p. 222

Available frame colours



Tech.info:

p. 304



QUARTO

Inspiration p. 223

Available frame colours



Tech.info:

p. 305



SIENA

Inspiration p. 224

Available frame colour



Tech.info:

p. 306



LIVORNO

Inspiration p. 225

Available frame colour



Tech.info:

p. 307



MILANO

Inspiration p. 226

Available frame colour



Tech.info:

p. 308



CAPRI

Inspiration p. 227

Available frame colours



Tech.info:

p. 309

- CHAIRS
- LOUNGE CHAIRS
- SOFAS
- LOUNGERS
- LOW TABLES
- BENCHES
- DINING TABLES

BAR TABLES

- BAR STOOLS
- BISTRO TABLES
- OUTDOOR RUGS
- ACCESSORIES
- UMBRELLAS
- CUSHION BOXES

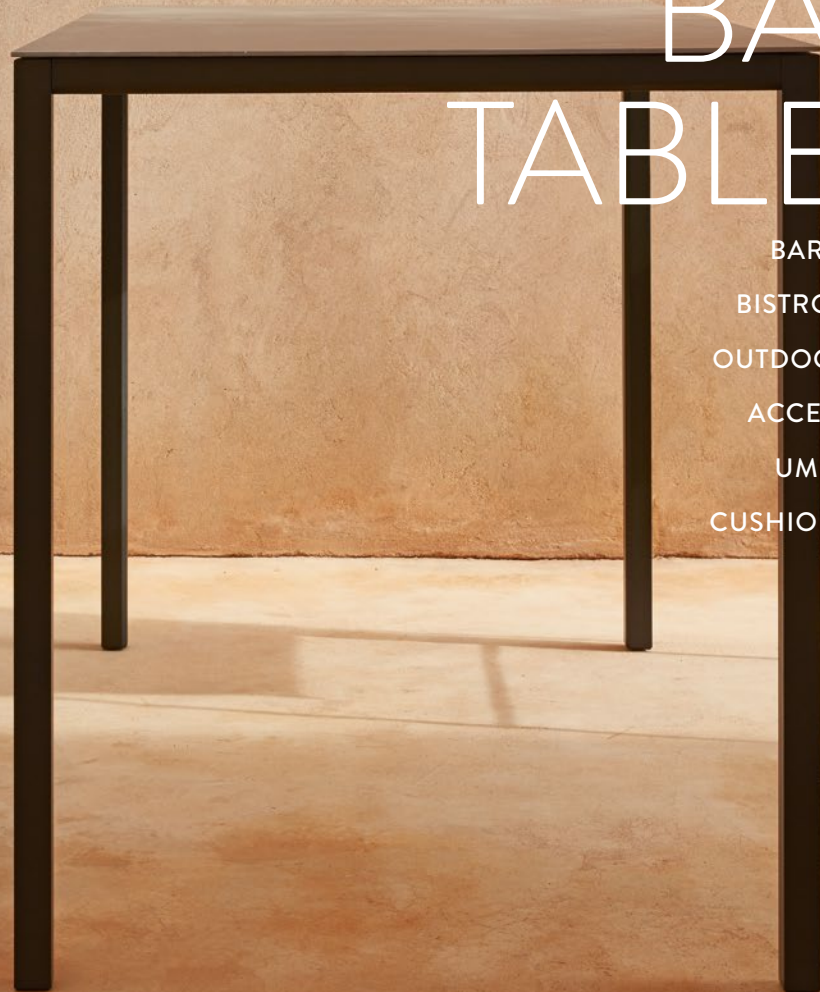

TRENTO

Inspiration p. 222

Available frame colours



Tech.info:

p. 304



QUARTO

Inspiration p. 223

Available frame colours



Tech.info:

p. 305



NAPOLI

Inspiration p. 229

Available frame colours



Tech.info:

p. 310

CHAIRS
 LOUNGE CHAIRS
 SOFAS
 LOUNGERS
 LOW TABLES
 BENCHES
 DINING TABLES
 BAR TABLES
**BAR
 STOOLS**
 BISTRO TABLES
 OUTDOOR RUGS
 ACCESSORIES
 UMBRELLAS
 CUSHION BOXES



MOOD

Inspiration p. 146

Available colour combinations



Tech.info:

p. 284



LATONA

Inspiration p. 178

Available colour combinations



Tech.info:

p. 289

CHAIRS
 LOUNGE CHAIRS
 SOFAS
 LOUNGERS
 LOW TABLES
 BENCHES
 DINING TABLES
 BAR TABLES
 BAR STOOLS

BISTRO TABLES

OUTDOOR RUGS
 ACCESSORIES
 UMBRELLAS
 CUSHION BOXES



TORSA

Inspiration p. 228

Available frame colours



Tech.info:

p. 299



NAPOLI

Inspiration p. 229

Available frame colours



Tech.info:

p. 310

CHAIRS
 LOUNGE CHAIRS
 SOFAS
 LOUNGERS
 LOW TABLES
 BENCHES
 DINING TABLES
 BAR TABLES
 BAR STOOLS
 BISTRO TABLES

OUTDOOR RUGS

ACCESSORIES
 UMBRELLAS
 CUSHION BOXES



STEPS

Available colours



Tech.info:

p. 318



LINEAR

Available colours



Tech.info:

p. 318



TWIST

Available colours



Tech.info:

p. 318

ACCESSORIES

CHAIRS
 LOUNGE CHAIRS
 SOFAS
 LOUNGERS
 LOW TABLES
 BENCHES
 DINING TABLES
 BAR TABLES
 BAR STOOLS
 BISTRO TABLES
 OUTDOOR RUGS
 UMBRELLAS
 CUSHION BOXES



SIDETABLES

Available colours



Tech.info:

p. 312



FLAME

Available colours



Tech.info:

p. 315



TROLLEYS

Available colours





TRAYS

Available colours



Tech.info:

p. 313



TWILIGHT

Available colours



Tech.info:

p. 315



TOWEL RACK

Available colours



Tech.info:

p. 313



KUMO POUFS

Available in all fabric colours



Tech.info:

p. 314



MOON ISLAND POUFS

Available in all fabric colours



Tech.info:

p. 314



POUFS

Available in all fabric colours



Tech.info:

p. 314

CHAIRS

LOUNGE CHAIRS

SOFAS

LOUNGERS

LOW TABLES

BENCHES

DINING TABLES

BAR TABLES

BAR STOOLS

BISTRO TABLES

OUTDOOR RUGS

ACCESSORIES

CUSHION BOXES

UMBRELLAS



CENTRAL POLE

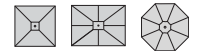

Available colours



Tech.info:

p. 316



SMALL CENTRAL POLE



Available colours



Tech.info:

p. 317

CHAIRS
 LOUNGE CHAIRS
 SOFAS
 LOUNGERS
 LOW TABLES
 BENCHES
 DINING TABLES
 BAR TABLES
 BAR STOOLS
 BISTRO TABLES
 OUTDOOR RUGS
 ACCESSORIES
 UMBRELLAS

CUSHION BOXES



POWDER COATED

Available colours



Tech.info:

p. 319



TEAK

Available colours



Tech.info:

p. 319



WICKER

Available colours



Tech.info:

p. 319

Technical specifications Furniture

Measurements,
finishings, concepts
and more





KUMO collection

Designed by Lionel Doyen



Materials & colours

FRAME
PCA



Cushions

Suggested colour combo - see back cover (flap)

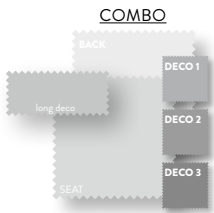

A1 - A6 - A7
B9 - B11 - B13

Features



modular system

Options



protective cover
see page 342

SUGGESTED CONCEPTS

CONCEPT 1

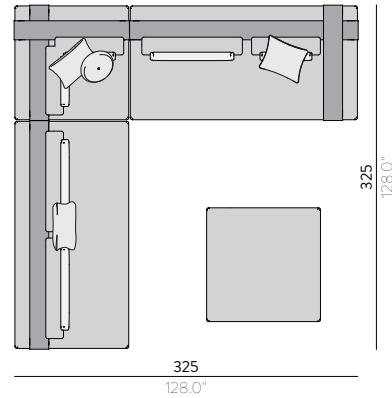

CONCEPT 2

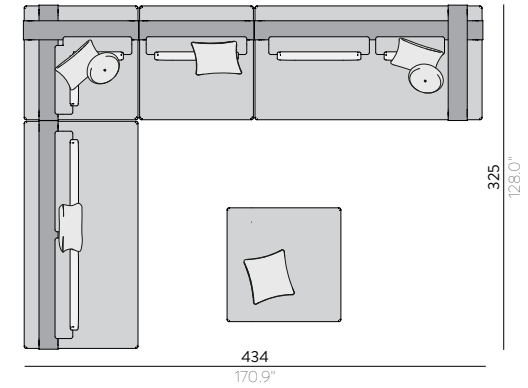

CONCEPT 3

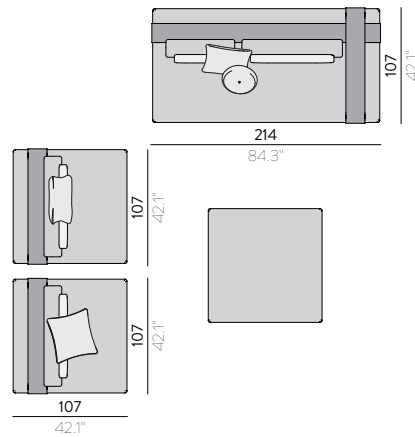

CONCEPT 4

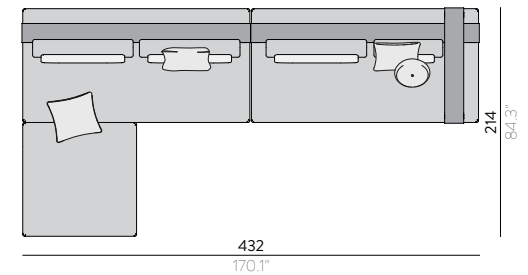

CONCEPT 5

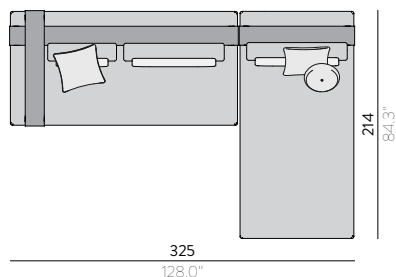

CONCEPT 6

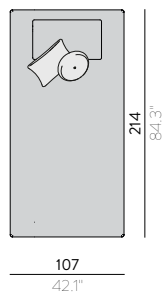

ALL AVAILABLE ITEMS FOR CUSTOMISED COMPOSITIONS

BASE+SEAT 214 / FS-KO214+SC214

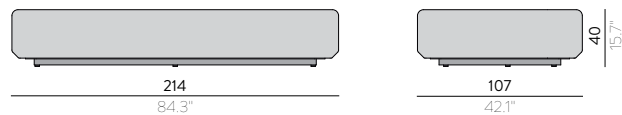

BASE+SEAT 107 / FS-KO107+SC107

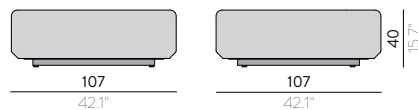

POUF 50 / FS-KOPF50

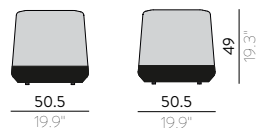

BACKREST / FS-BR216X55

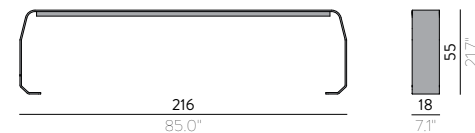

BACKREST / FS-BR109X55

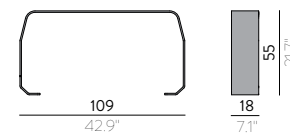

ARMREST / FS-AR109X57

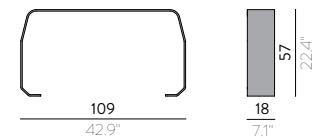

ELEMENTS collection

Designed by Gerd Couckhuys



Materials & colours

BASE
PCA

FRAME - TOP PLATE
PCA - Quaryl®



F7
black



F8
white
Q8-Quaryl®
by Villeroy&Boch®

Cushions

Suggested colour combo - see back cover (flap)

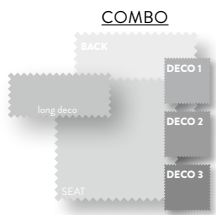

B15 - B20

REGULAR

long deco cushion incl.



A2 - B10

CASUAL

Features



modular
system



reclining
back 30°



remote controlled
LED-lighting



protective cover
see page 342

Options

SUGGESTED CONCEPTS

CONCEPT 1

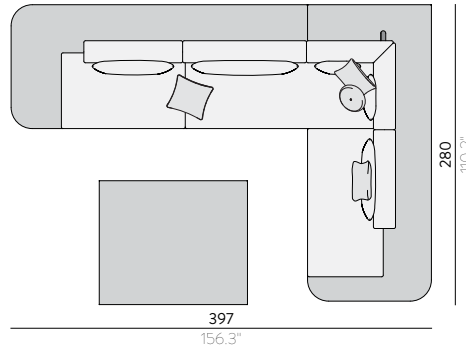

CONCEPT 2

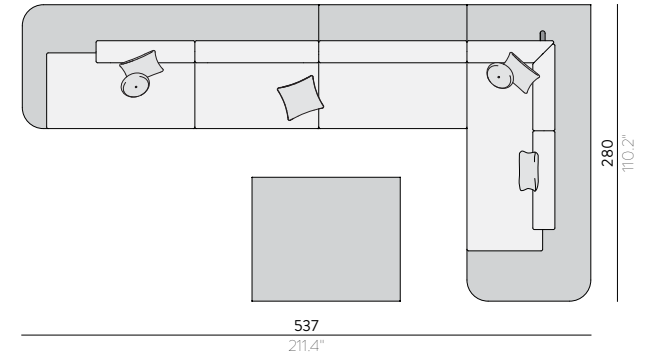

CONCEPT 3

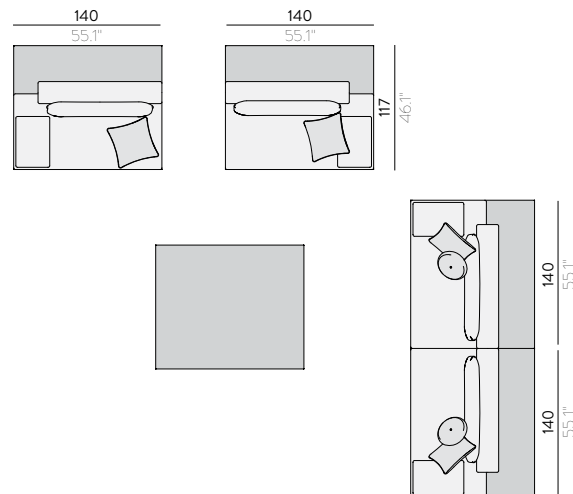

CONCEPT 4

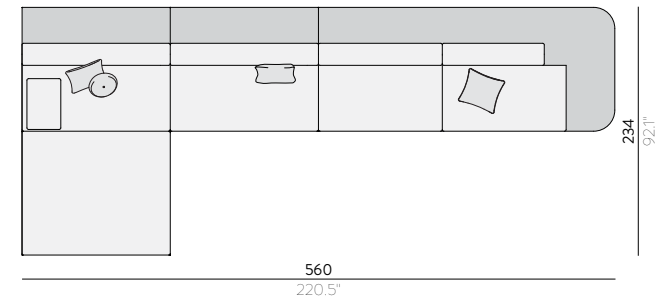

CONCEPT 5

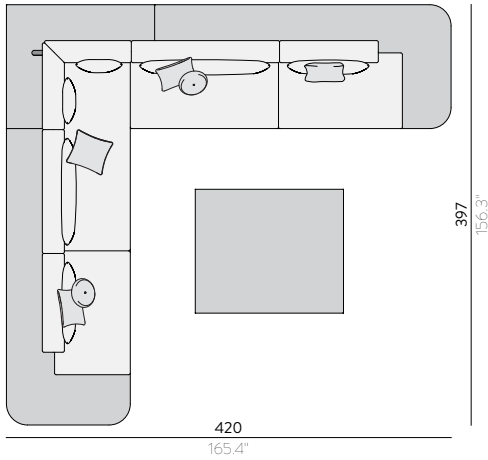

CONCEPT 6

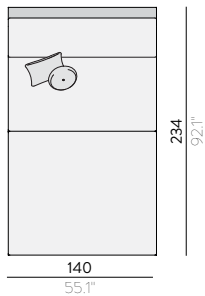

ALL AVAILABLE ITEMS FOR CUSTOMISED COMPOSITIONS



LEFT END SEAT 280 / FS-ESELS

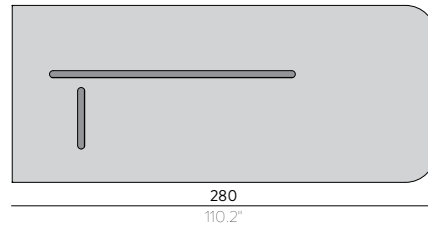

RIGHT END SEAT 280 / FS-ESERS

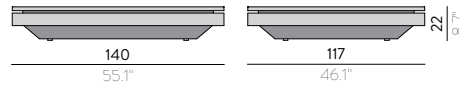
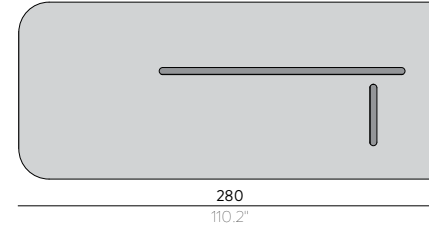

CORNER SEAT 140 / FS-ESCS

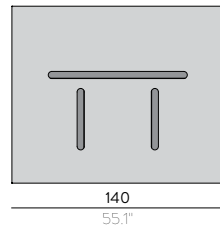

LARGE MIDDLE SEAT 140 / FS-ESMSL

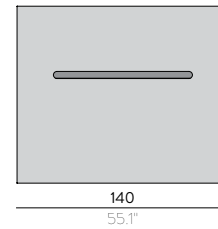

LARGE FOOTSTOOL / COFFEE TABLE 140 / FS-ESFL

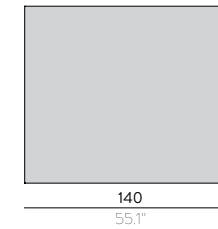

FOOTREST 70 / FS-ESFR

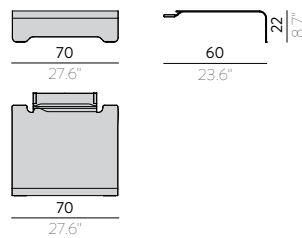

SIDETABLE 35 / FS-ESST

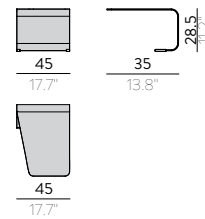

TROLLEY FOR BACKRESTS / FS-TY01

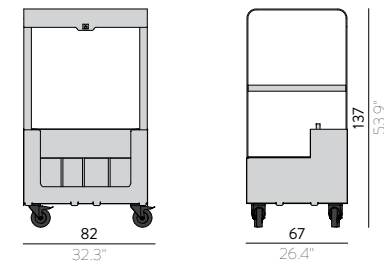

AIR collection

Designed by Koen Van Extergem



Materials & colours

FRAME - FINISHING

PCSTS - alu

PCSTS - iroko

PCSTS - iroko

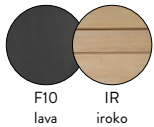

Cushions

Suggested colour combo - see back cover (flap)

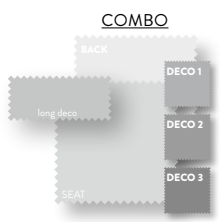

A1 - A2 - A5 - B18

Features



Options



remote controlled LED-lighting

SUGGESTED CONCEPTS

CONCEPT 1

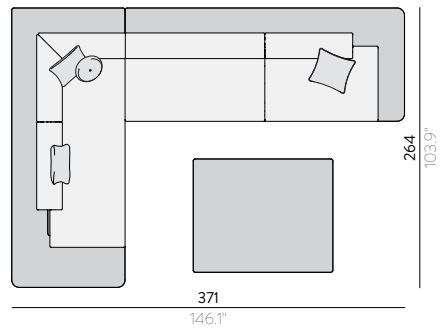

CONCEPT 2

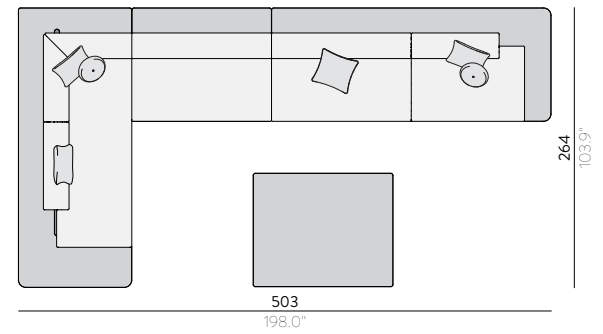

CONCEPT 3

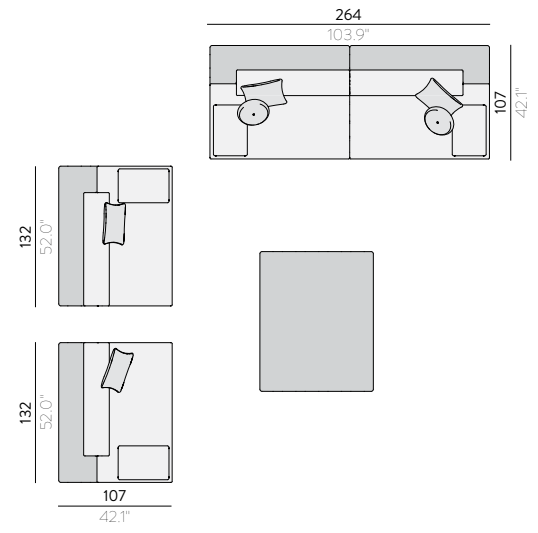

CONCEPT 4

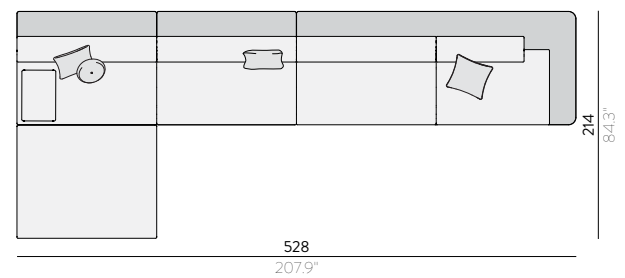

CONCEPT 5

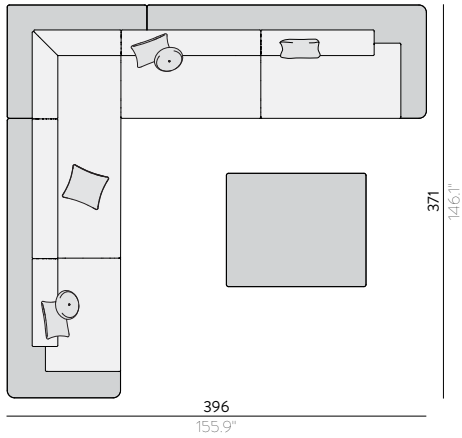

CONCEPT 6

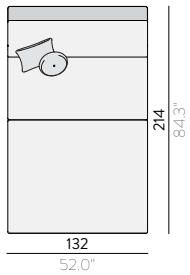

ALL AVAILABLE ITEMS FOR CUSTOMISED COMPOSITIONS

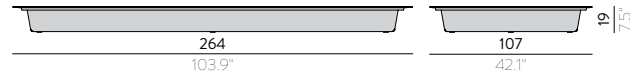

LEFT END SEAT / FS-ARELS

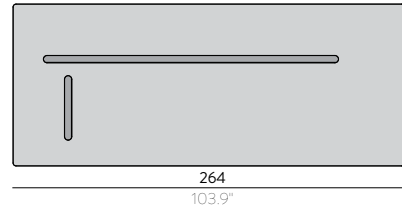

RIGHT END SEAT / FS-ARERS

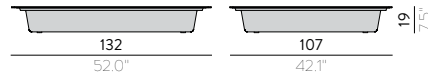
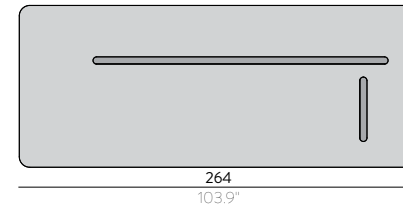

CORNER / FS-ARCS

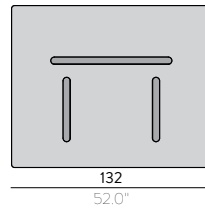

LARGE MIDDLE SEAT / FS-ARMSL

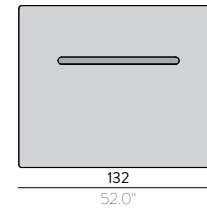

LARGE FOOTSTOOL / COFFEE TABLE 140 / FS-ESFL

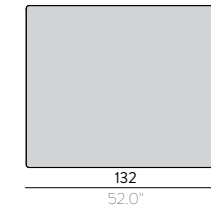

TROLLEY / FS-TY02

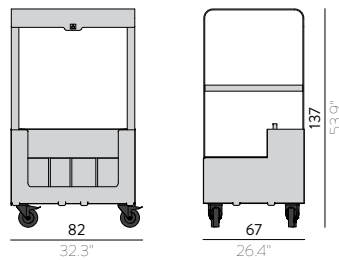

SAN collection

Designed by Lionel Doyen



BENCH (BASE 200) / FS-SN200

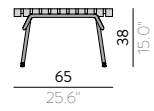
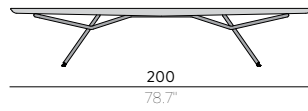

MARBLE ROUND 40 / FS-SNMAR40

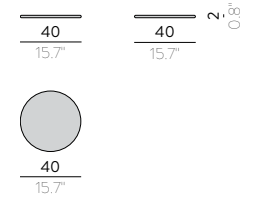

Materials & colours

FRAME - FINISHING
PCSTS - iroko

FINISHING ACCESSORY
marble

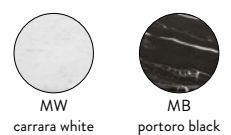
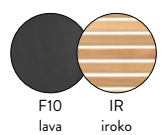

SOFA / FS-SNC1

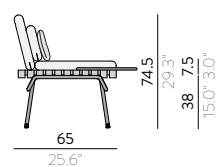
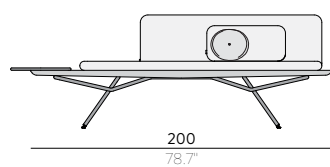

MARBLE RECTANGULAR 60 / FS-SNMAR60

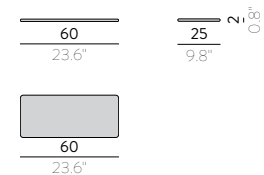

Cushions

Suggested colour combo - see back cover (flap)

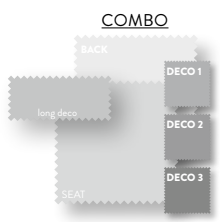

A7 - B9 - B10

DOUBLE 1SEATER / FS-SNC2

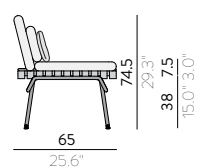
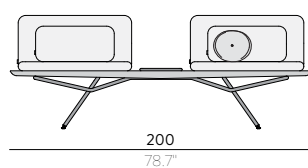

Options



LOUNGER / FS-SNC3

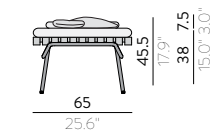
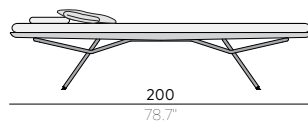



MOON ISLAND collection

Designed by Gerd Couckhuyt



Materials & colours

FRAME
PCA

FINISHING
nautic leather

nautic Batyline®



33N
white

T11N
sand

Cushions

Suggested colour combo - see back cover (flap)

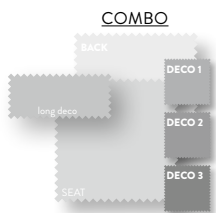

A3 - A4

Features

Options



modular system



possibility to customise with fabrics from CAT.A and CAT.B



protective cover see page 342

SUGGESTED CONCEPTS

CONCEPT 1

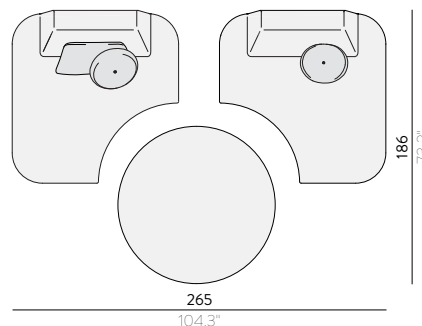

CONCEPT 2

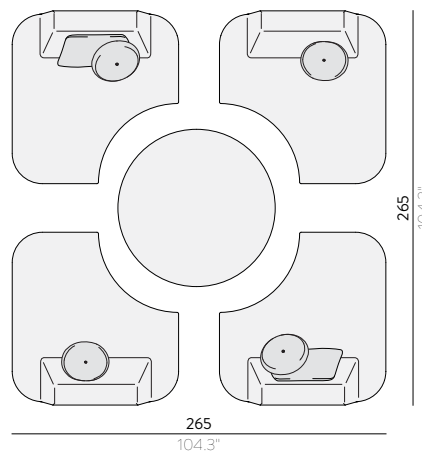

MOON ISLAND collection

Designed by Gerd Couckhuys

ALL AVAILABLE ITEMS FOR CUSTOMISED COMPOSITIONS

LEFT CORNER / FS-MILCS

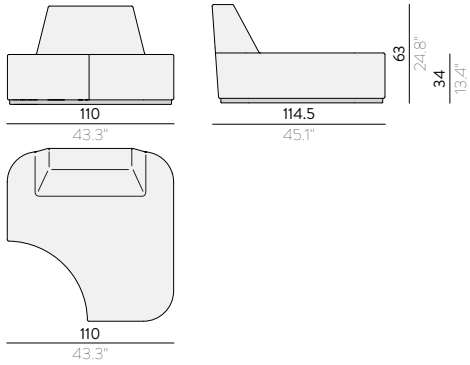

FOOTSTOOL / SIDETABLE 52 / FS-MIFS52

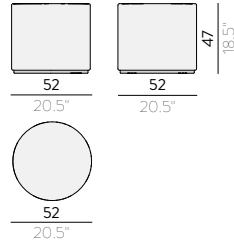

RIGHT CORNER / FS-MIRCS

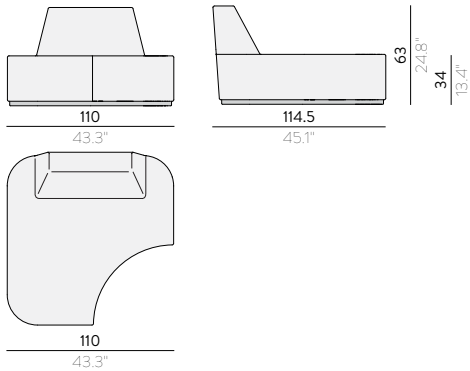

FOOTSTOOL / SIDETABLE 63 / FS-MIFS63

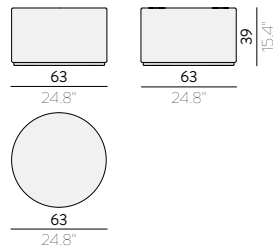

LOUNGE TABLE / FOOTSTOOL 104 / FS-MILT

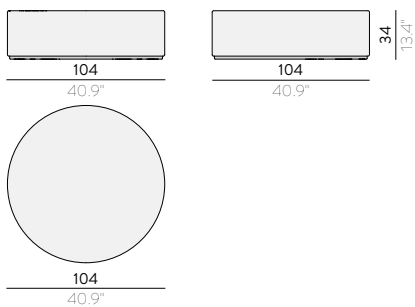



Materials & colours

FINISHING

rope



R3 anthracite



R4 pepper

Cushions

Suggested colour combo - see back cover (flap)

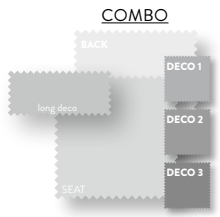

A1 - A7 - B11 - B12

Options



protective cover
see page 342

1S / FS-1S46

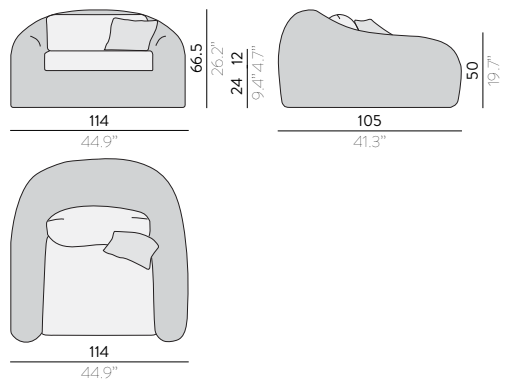

3S / FS-2S94

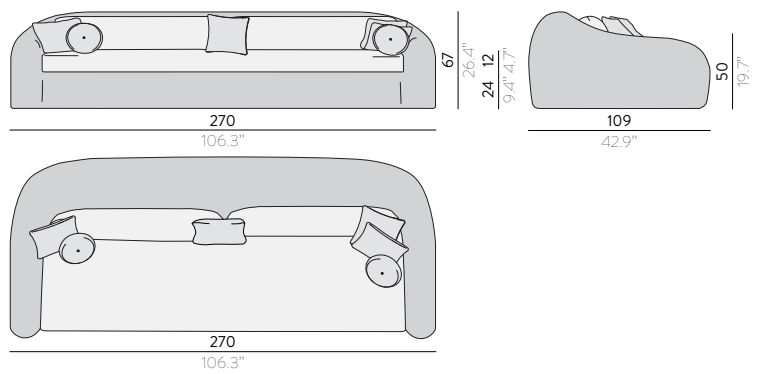

CASCADE collection

Designed by Manutti Design Studio



Materials & colours

FRAME - FINISHING

PCA - rope

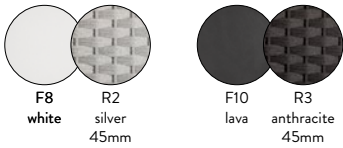

Cushions

Suggested colour combo - see back cover (flap)

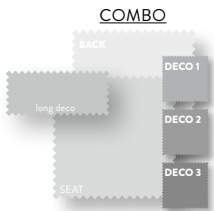

B10 - B11 - B13

Options



protective cover
see page 342

1S / FS-1S44

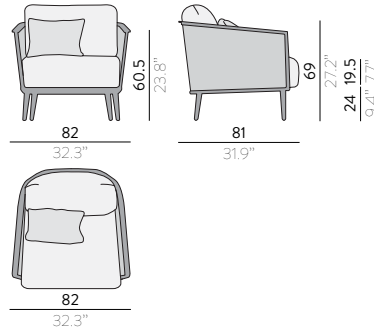

3S / FS-2S90

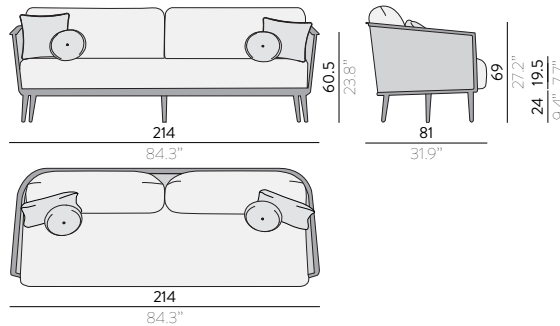

DAYBED / FS-DB01

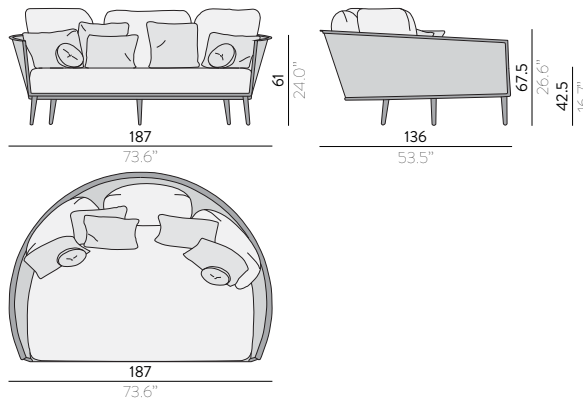

DUO collection

Designed by Koen Van Extergem



CHAIR / FS-CH39

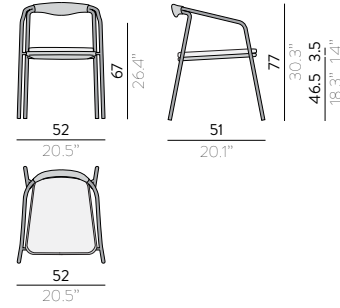

ROCKING CHAIR / FS-RC02

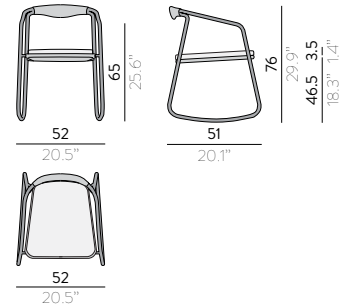

Materials & colours

FRAME - FINISHING

PCA - rope

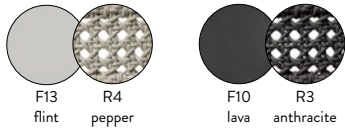

Cushions

Suggested colour combo - see back cover (flap)



Features



stackable chair

Options



protective cover
see page 342

RADIUS collection

Designed by Manutti Design Studio



Materials & colours

FRAME - FINISHING

PCSTS - rope

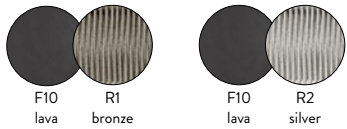

Cushions

Suggested colour combo - see back cover (flap)

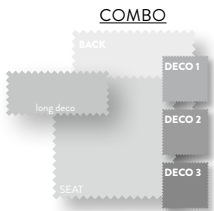

A5 - B13

Options



protective cover
see page 342

CHAIR / FS-CH40

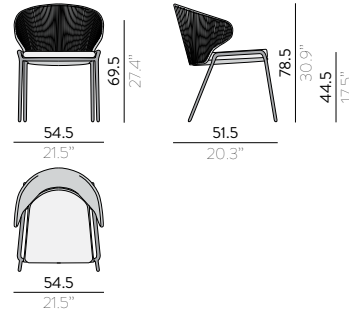



Materials & colours

FRAME - FINISHING

PCSTS - rope

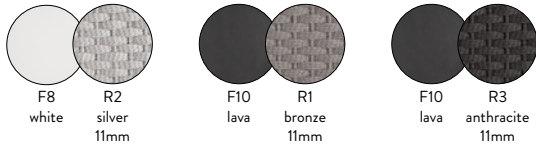

No cushions

Features



stackable chair

Options



protective cover
see page 342

CHAIR / FS-CH38

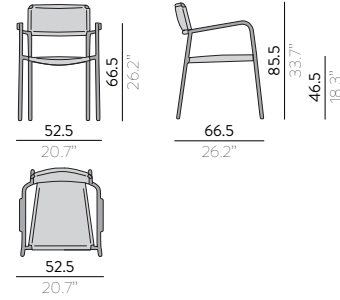

1S / FS-1S43

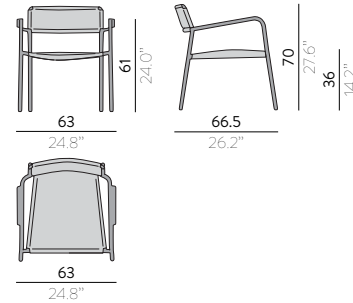

**Materials & colours****FRAME - FINISHING**

PCSTS - outdoor fabric

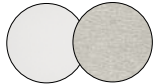
F8
white27
smokeyF10
lava28
sparrowF10
lava40
milestone

PCSTS - nautic leather

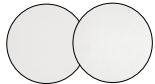
F8
white33N
white**No cushions****Features**

stackable chair

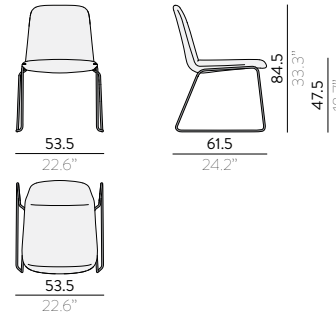
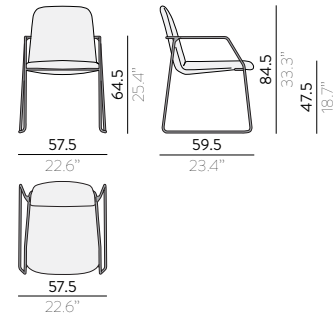
Optionsprotective cover
see page 342possibility to customise
with fabrics from
CAT. A and CAT. B**DINING CHAIR / FS-DC31****CHAIR / FS-CH35**

ZENDO collection

Designed by Manutti Design Studio



Materials & colours

STANDARD COMBINATIONS FRAME - FINISHING

PCA - outdoor fabric

PCA - nautic leather

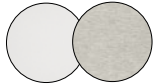

F8 white
28 smokey



F10 lava
28 sparrow

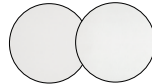

F8 white
33N white

OPTIONAL COMBINATIONS FRAME - FINISHING

PLEASE REFER TO PRICELIST

Cushions

Suggested colour combo - see back cover (flap)

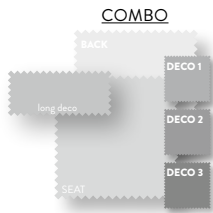

A4 - B16 - B17

Features



modular system



with wheels

Options



protective cover
see page 342

SUGGESTED CONCEPTS

CONCEPT 1

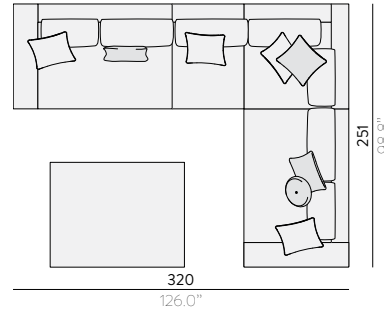

CONCEPT 2



CONCEPT 3

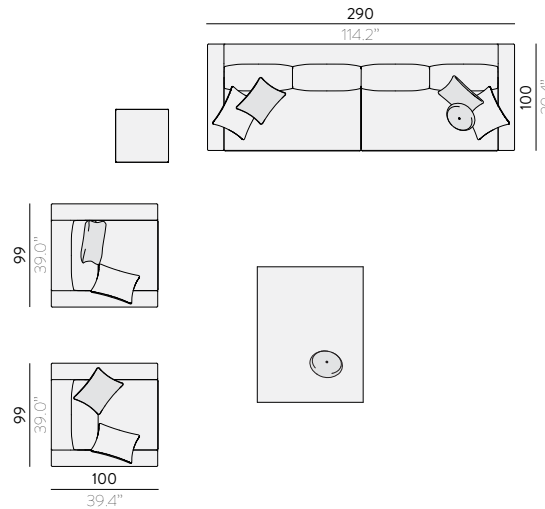

CONCEPT 4

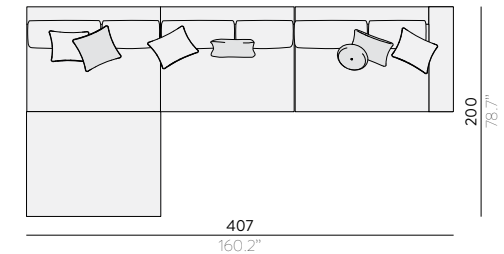

ZENDO collection

Designed by Manutti Design Studio

ALL AVAILABLE ITEMS FOR CUSTOMISED COMPOSITIONS

CLUB CHAIR / FS-CH30

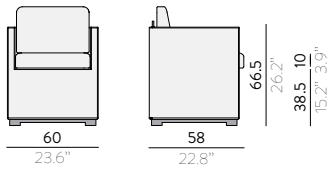

1S / FS-ZO1S

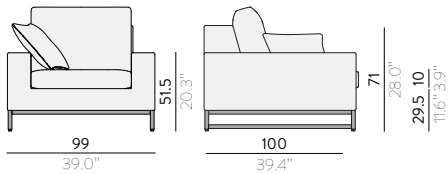

2.5S / FS-ZO2S

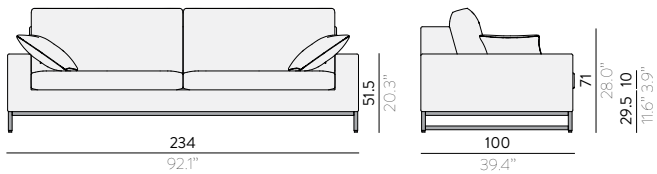

3S / FS-ZO3S

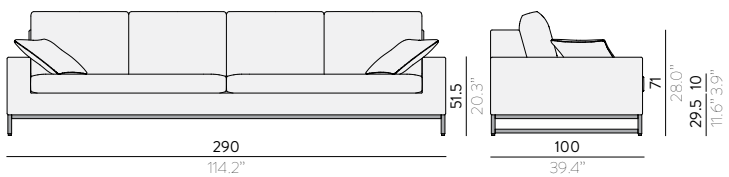

LEFT SEAT / FS-ZOLS

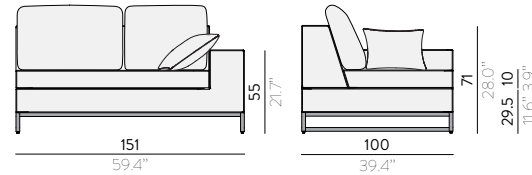

RIGHT SEAT / FS-ZORS

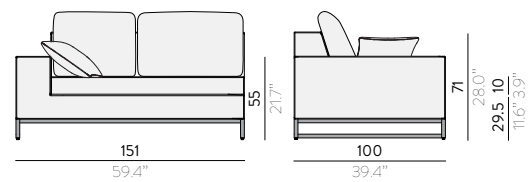

CORNER / FS-ZOCS

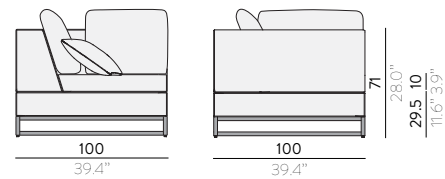

LARGE MIDDLE SEAT / FS-ZOMSL

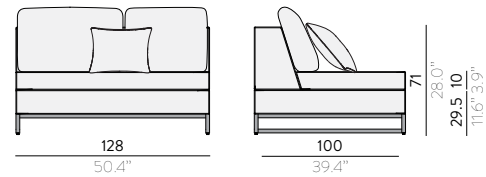

SMALL MIDDLE SEAT / FS-ZOMSS

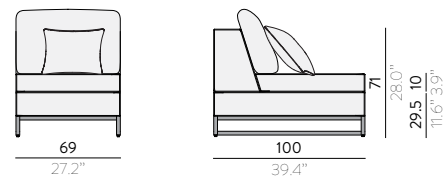

LARGE FOOTSTOOL / SIDETABLE / FS-ZOFL

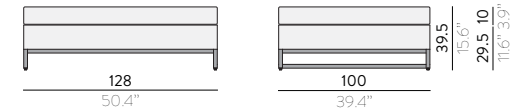

MEDIUM FOOTSTOOL / SIDETABLE / FS-ZOFM

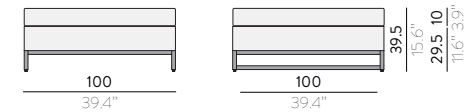

SMALL FOOTSTOOL / SIDETABLE / FS-ZOFS

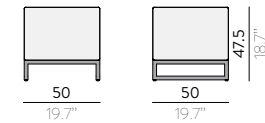

LOUNGER / FS-ZOLO

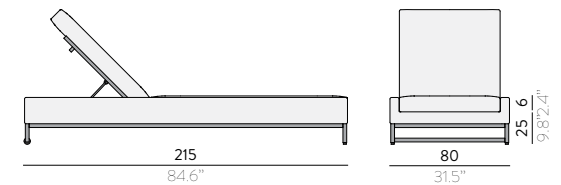



LINER collection

Designed by Bram Bollen



Materials & colours

STANDARD COMBINATIONS FRAME - FINISHING

PCA - outdoor fabric

PCA - nautic leather



OPTIONAL COMBINATIONS FRAME - FINISHING

PLEASE REFER TO PRICELIST

Cushions

Suggested colour combo - see back cover (flap)

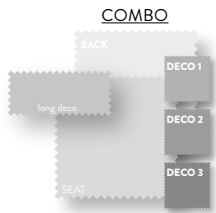

A4 - B16 - B17

Features

Options



with wheels



protective cover
see page 342

CHAIR / FS-CH25

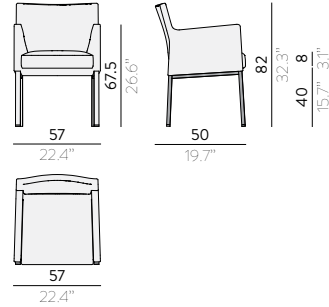

1S / FS-1S40

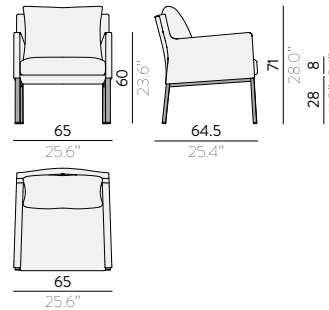

LOUNGER / FS-LO53

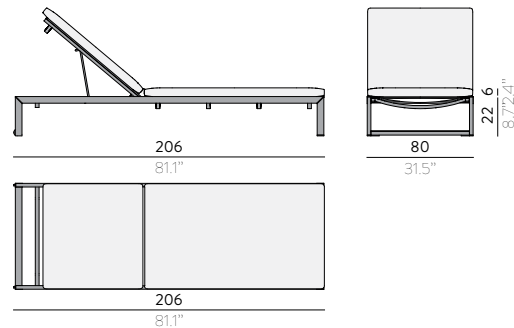

SQUAT collection

Designed by Manutti Design Studio



Materials & colours

PCSTS - nautic fabric

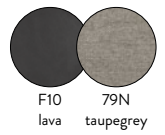

Cushions

Suggested colour combo - see back cover (flap)

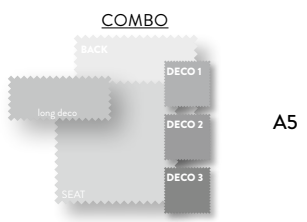

Features



modular system

Options



headrest 60cm or 75cm



protective cover see page 342

SUGGESTED CONCEPTS

CONCEPT 1

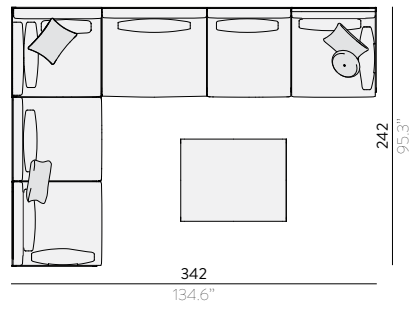

CONCEPT 2

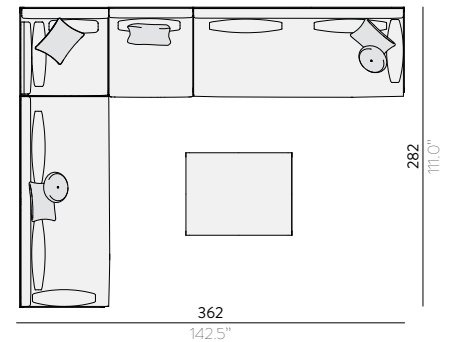

CONCEPT 3

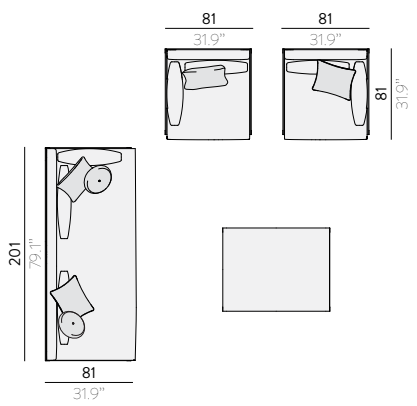

CONCEPT 4

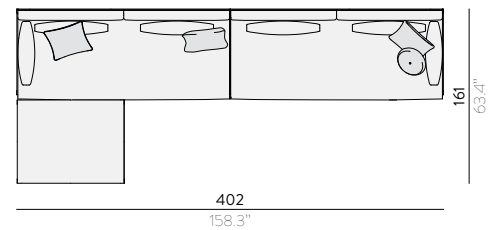

ALL AVAILABLE ITEMS FOR CUSTOMISED COMPOSITIONS

1S / FS-ST1S

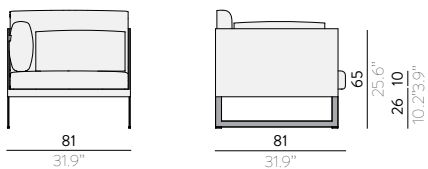

CORNER / FS-STCS

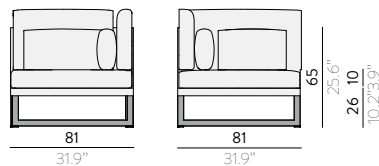

RIGHT SEAT / FS-STRS

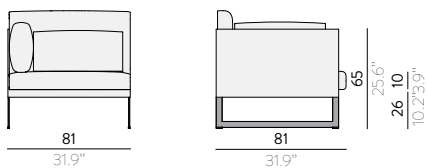

SMALL MIDDLE SEAT / FS-STMSS

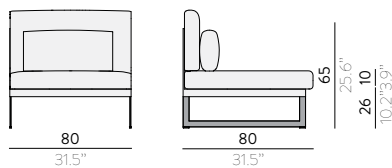

RIGHT CORNER DOUBLE SEAT / FS-STRDRS

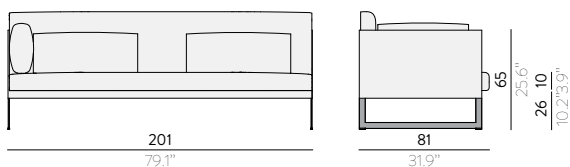

LARGE MIDDLE SEAT / FS-STMSL

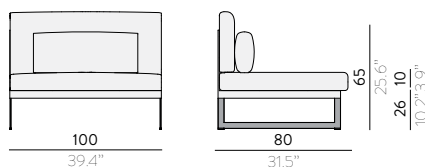

LEFT SEAT / FS-STLS

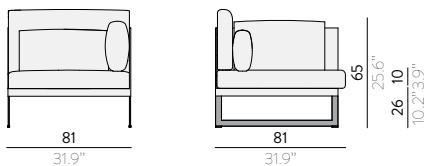

LARGE FOOTSTOOL / SIDETABLE / FS-STFL

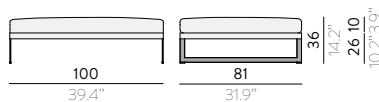

LEFT CORNER DOUBLE SEAT / FS-STDLS

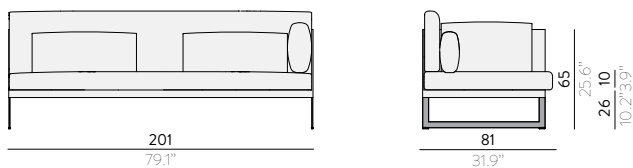

MEDIUM FOOTSTOOL / SIDETABLE / FS-STFM

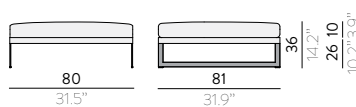

SWING collection

Designed by Manutti Design Studio



Materials & colours

FINISHING

Wicker 2mm

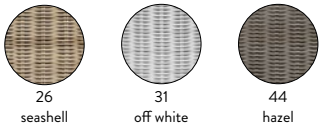

Cushions

Suggested colour combo - see back cover (flap)

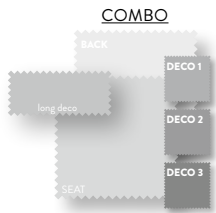

B16 - B17 - B20

Features



with wheels

CORD CHAIR / FS-CH26

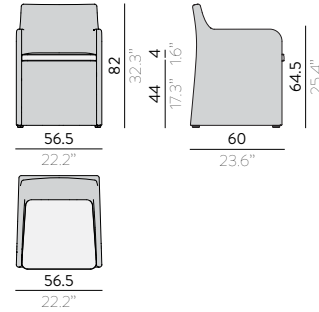

CORD LOUNGER / FS-LO52

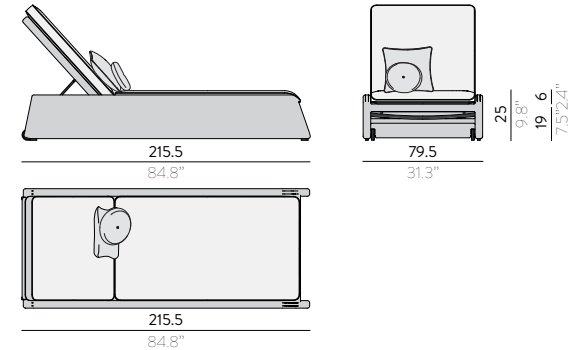

CORD IS / FS-1S38

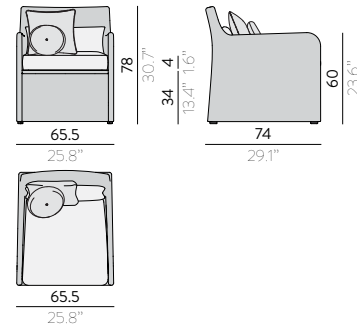

CORD SMALL FOOTSTOOL / SIDETABLE / FS-FR84S

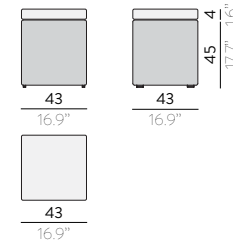

CORD MEDIUM FOOTSTOOL / FS-FR84M

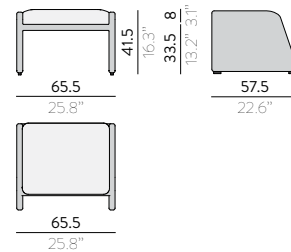

RIVER collection

Designed by Manutti Design Studio



Materials & colours

FINISHING
Wicker 6mm



84
old grey cord

Cushions

Suggested colour combo - see back cover (flap)

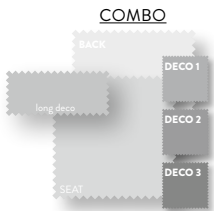

A2 - B14

Features



with wheels

Options



protective cover
see page 342

1S / FS-1S45

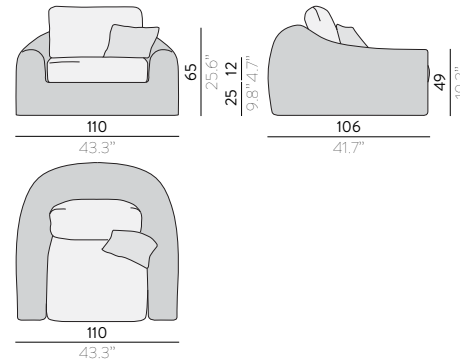

SUNBED LARGE / FS-SB05XL

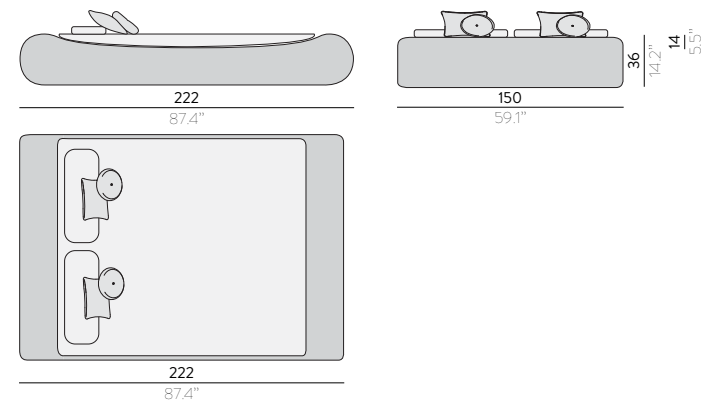

3S / FS-2S91

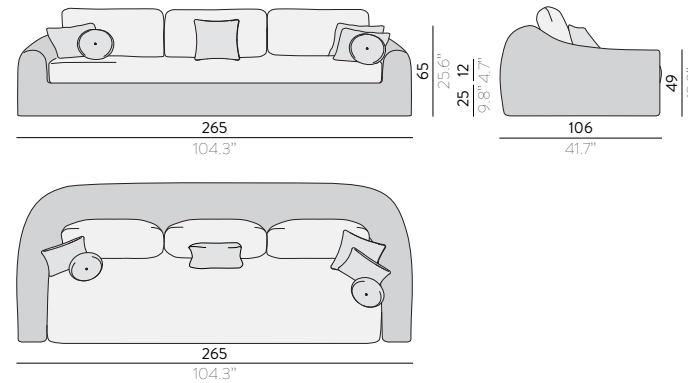

SUNBED SMALL / FS-SB05

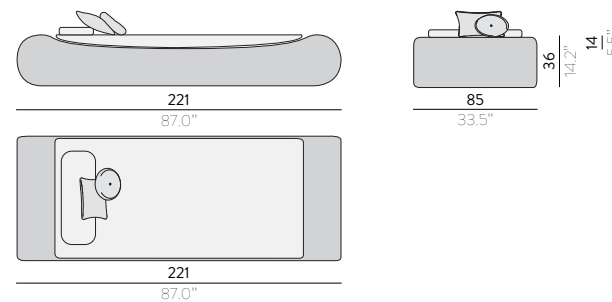

MOOD collection

Designed by Manutti Design Studio



Materials & colours

FINISHING

Wicker 2mm

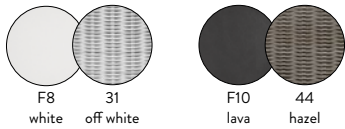

Cushions

Suggested colour combo - see back cover (flap)

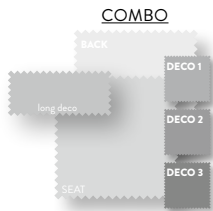

B16 - B17

CHAIR / FS-CH29

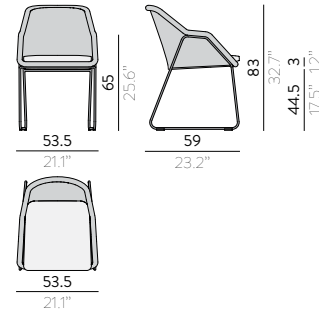

BARSTOOL 80 / FS-BS64

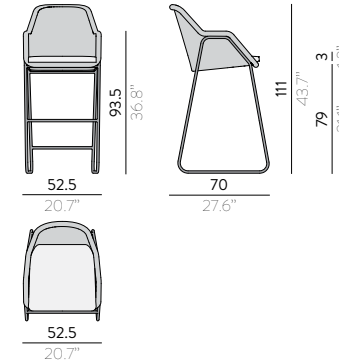

1S / FS-1S39

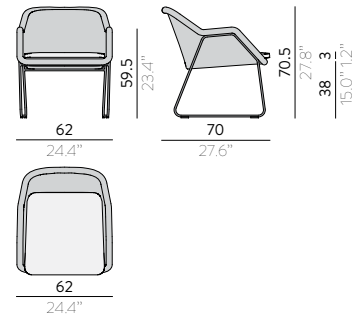

BARSTOOL 60 / FS-BS64L

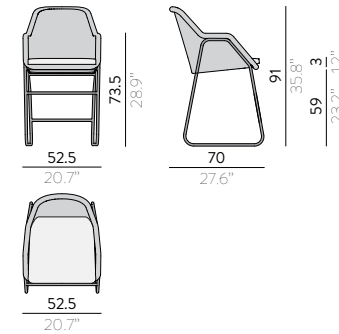

SOLID collection

Designed by Lionel Doyen



ARMCHAIR / FS-CH41

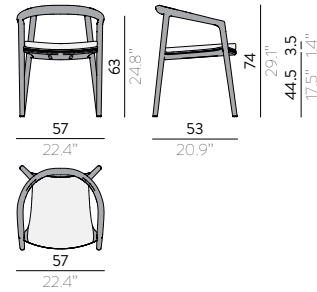

Materials & colours

FRAME

teak



Cushions

Suggested colour combo - see back cover (flap)

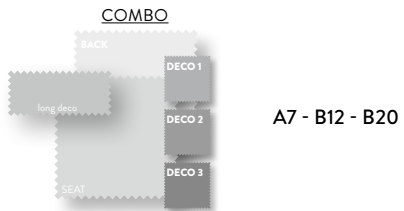

Features

Options



stackable chair



removable back cushion

SIENA collection

Designed by Manutti Design Studio



Materials & colours

FRAME
teak



FINISHING (only for chair and lounger)
textiles

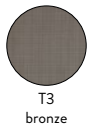

Cushions

Suggested colour combo - see back cover (flap)

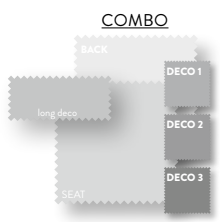

B13 - B20

Features



modular system



stackable chair



with wheels

SUGGESTED CONCEPTS

CONCEPT 1

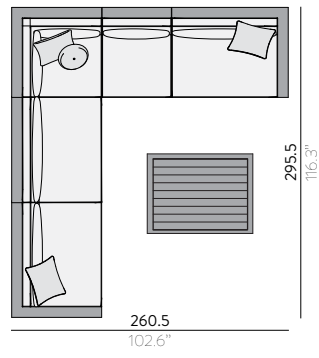

CONCEPT 2

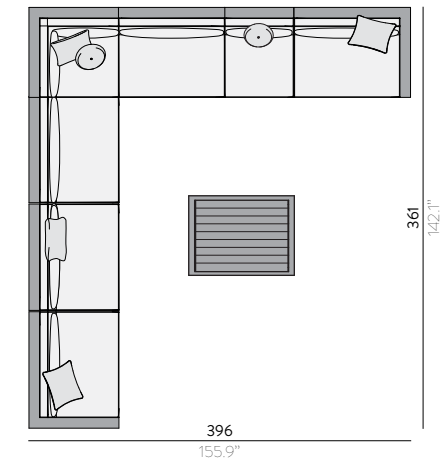

CONCEPT 3

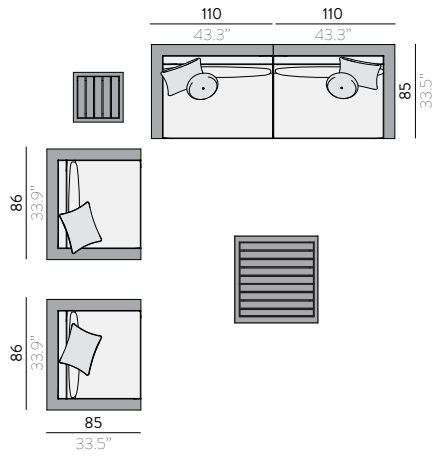

CONCEPT 4

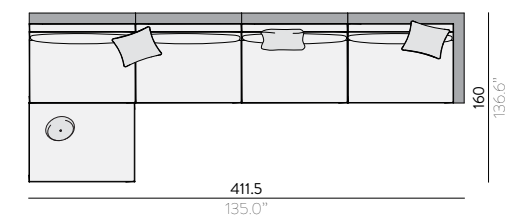

SIENA collection

Designed by Manutti Design Studio

ALL AVAILABLE ITEMS FOR CUSTOMISED COMPOSITIONS

TEAK TEXTILES CHAIR / FS-TKCH03

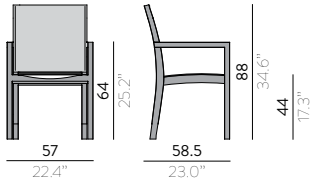

TEAK TEXTILES LOUNGER / FS-TKLO02

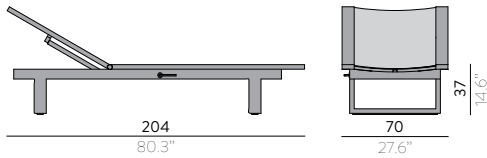

TEAK CHAIR / FS-TKCH02

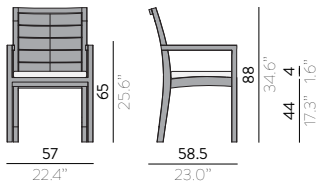

TEAK LOUNGER / FS-TKLO01

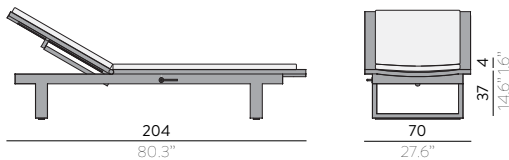

TEAK LOUNGE 1S / FS-TK1S01

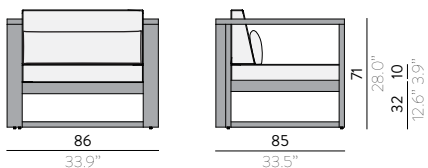

TEAK LOUNGE LEFT SEAT / FS-TKLS01

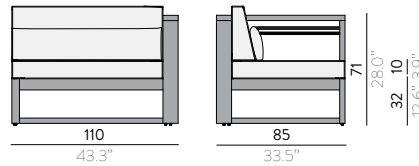

TEAK LOUNGE RIGHT SEAT / FS-TKRS01

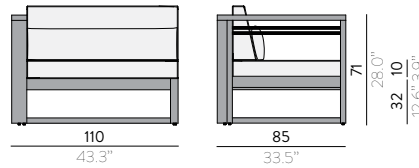

TEAK LOUNGE CORNER SEAT / FS-TKCS01

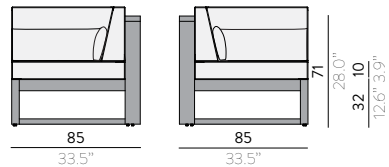

TEAK LOUNGE SMALL MIDDLE SEAT / FS-TKMSS01

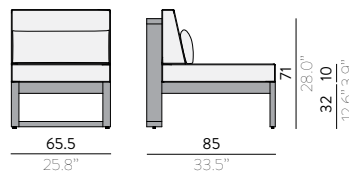

TEAK LOUNGE LARGE MIDDLE SEAT / FS-TKMSL01

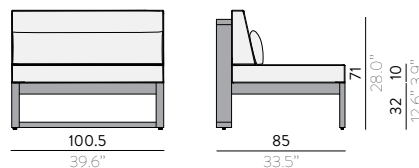
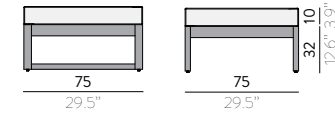
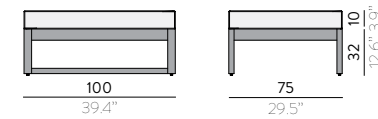
TEAK LOUNGE MEDIUM FOOTSTOOL /
SIDETABLE / FS-TKFM01TEAK LOUNGE LARGE FOOTSTOOL /
SIDETABLE / FS-TKFLO1

TEAK SIDETABLE / FS-TKCT01

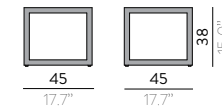

TEAK TOWEL RACK / FS-TKTR01

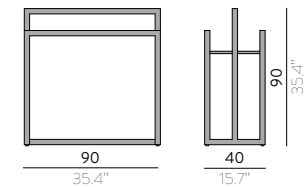

CROSS TEAK collection

Designed by Mads Ogdgård



CHAIR / FS-CH33TK

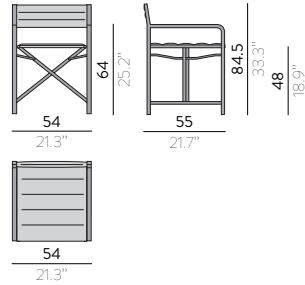

Materials & colours

FRAME - FINISHING

teak - textiles



CUSTOMISED FINISHING

selected fabrics

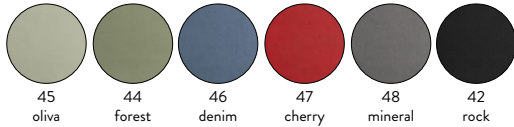

No cushions

Features



folding chair

Options



possibility to customise with selected fabrics

CROSS ALU collection

Designed by Manutti Design Studio



CHAIR / FS-CH33

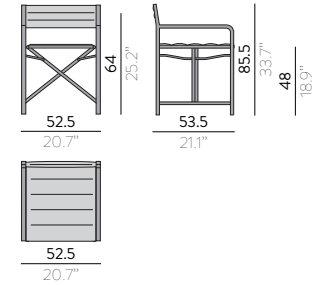

Materials & colours

FRAME - FINISHING

PCA - textiles



No cushions

Features



folding chair

LATONA collection

Designed by Manutti Design Studio



Materials & colours

FRAME - FINISHING

PCA - textiles

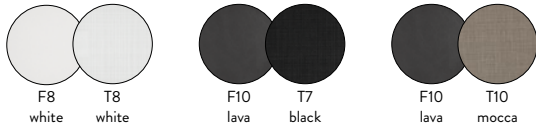

No cushions

No options

TEXTILES CHAIR / FS-CH12A

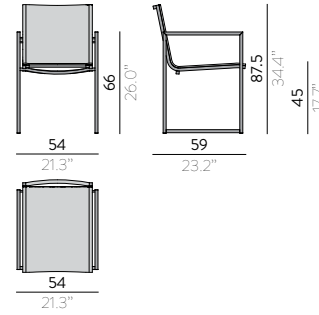

HELIOS TEXTILES BARSTOOL 80 / FS-BS65

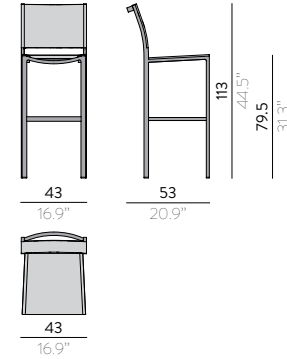

(HELIOS) TEXTILES LOUNGER / FS-LO54

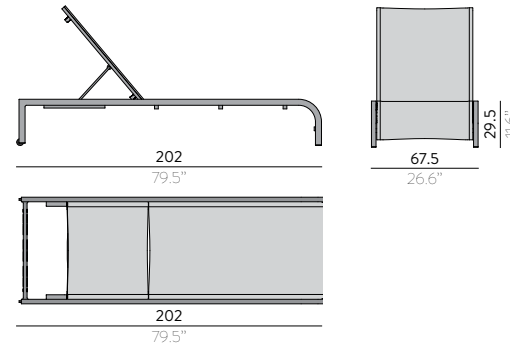

(HELIOS) TEXTILES BARSTOOL 60 / FS-BS65L

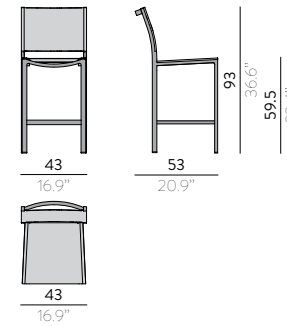

FUSE collection

Designed by Manutti Design Studio



Materials & colours

FRAME - FINISHING
PCA - rope



Cushions

Suggested colour combo - see back cover (flap)

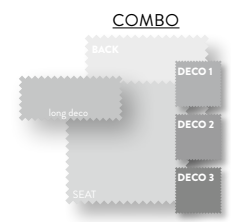

A8 - B13 - B15

Features

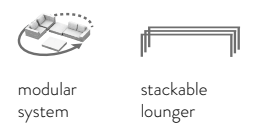

Options



SUGGESTED CONCEPTS

CONCEPT 1

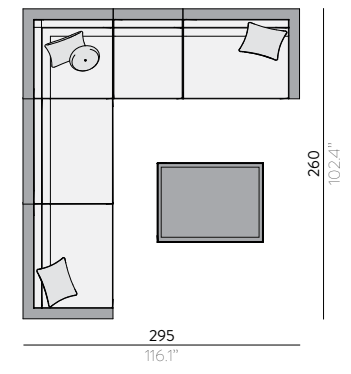

CONCEPT 2

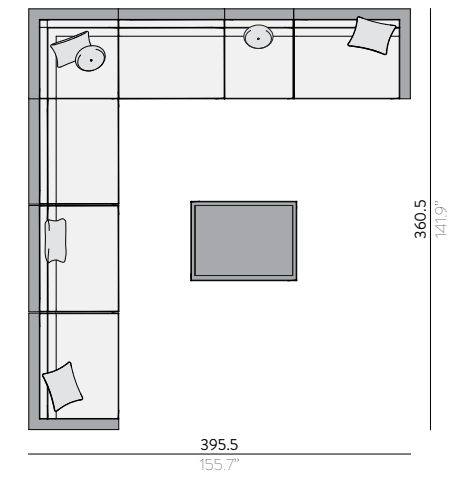

CONCEPT 3

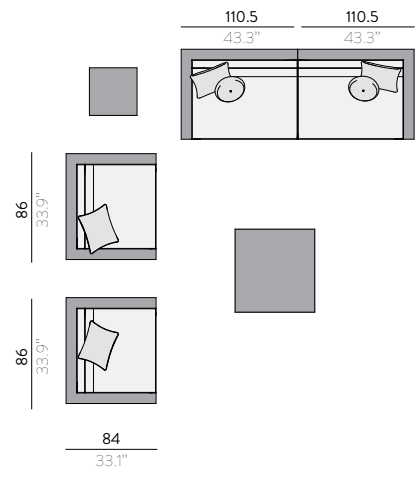

CONCEPT 4

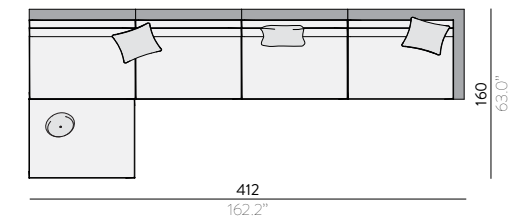

ALL AVAILABLE ITEMS FOR CUSTOMISED COMPOSITIONS

1S / FS-FE1S

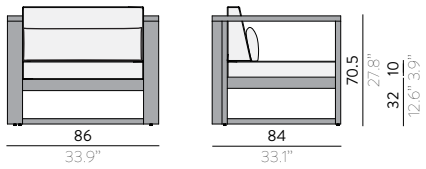

LARGE MIDDLE SEAT / FS-FEMSL

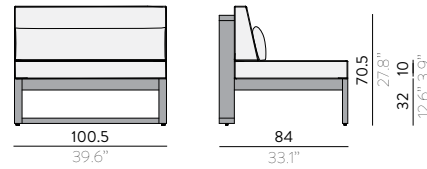

BENCH 300 (FULL ALU TOP) / FS-BE300

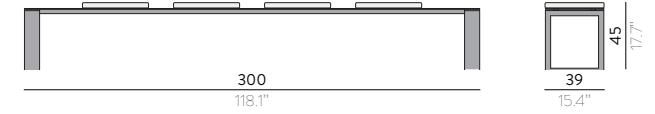

LEFT SEAT / FS-FELS

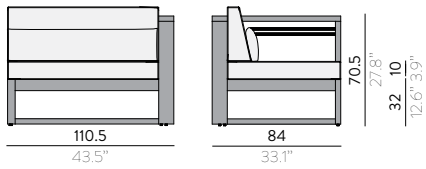

MEDIUM FOOTSTOOL / SIDETABLE / FS-FEFM

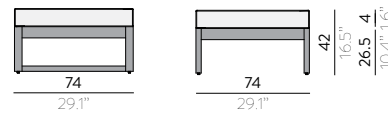

BENCH 45 (FULL ALU TOP) / FS-BE45

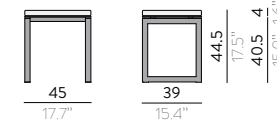

RIGHT SEAT / FS-FERS

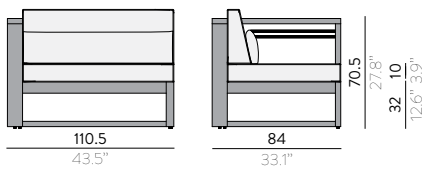

LARGE FOOTSTOOL / SIDETABLE / FS-FEFL

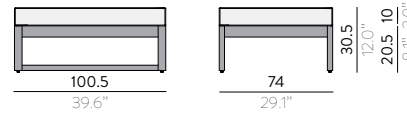

CORNER SEAT / FS-FECS

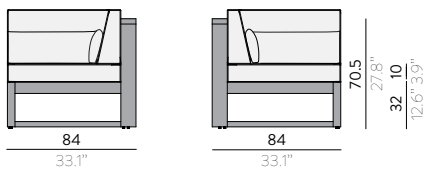

LOUNGER / FS-FELO

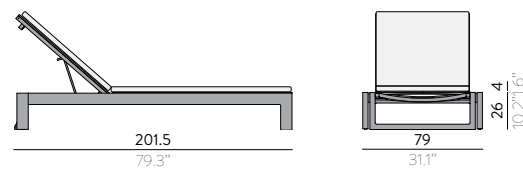

SMALL MIDDLE SEAT / FS-FEMSS

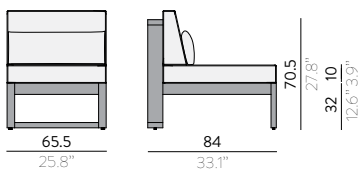

SIDETABLE / FS-CT88

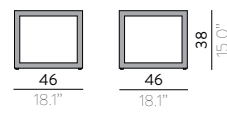

SAN DIEGO collection

Designed by Manutti Design Studio



Materials & colours

FINISHING

wicker 5mm wicker 8mm



84
old grey cord
(only for cord
round chair)

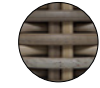

84
old grey cord

Cushions

Suggested colour combo - see back cover (flap)

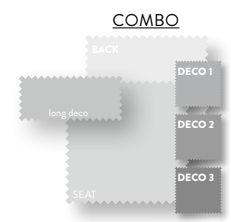

A8 - B15 - B20

Features



modular system



with wheels

Options



protective cover
see page 342

SUGGESTED CONCEPTS

CONCEPT 1

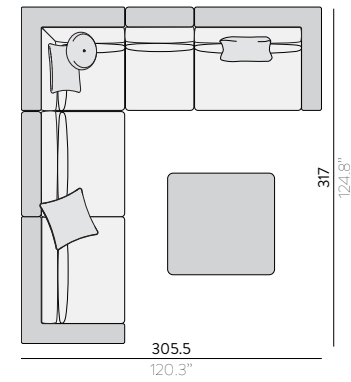

CONCEPT 2

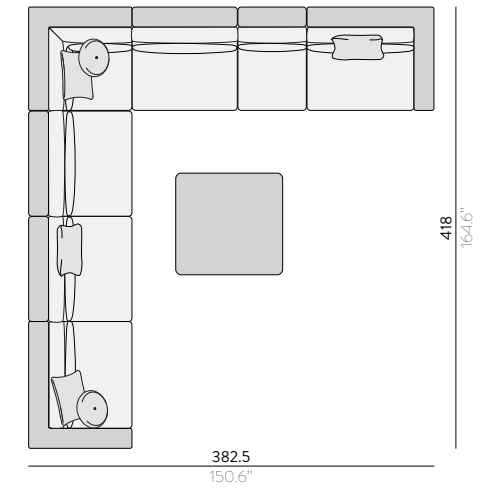

CONCEPT 3

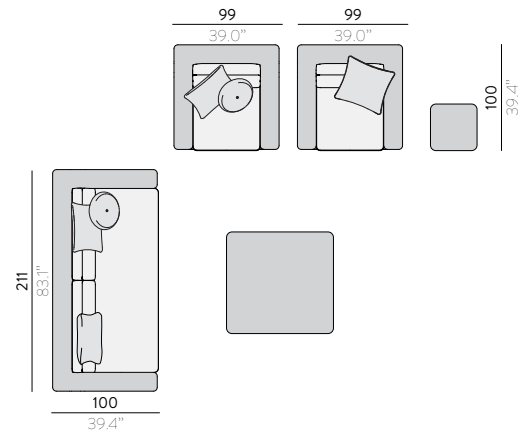

CONCEPT 4

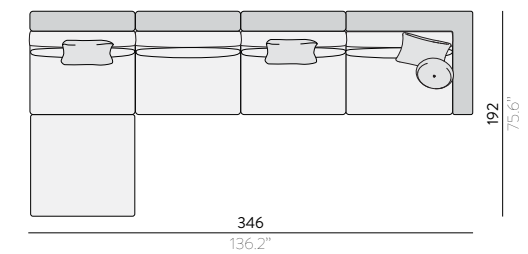

SAN DIEGO collection

Designed by Manutti Design Studio

ALL AVAILABLE ITEMS FOR CUSTOMISED COMPOSITIONS

CORD CHAIR / FS-CH19

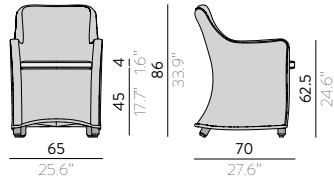

CORD ROUND CHAIR / FS-CH28

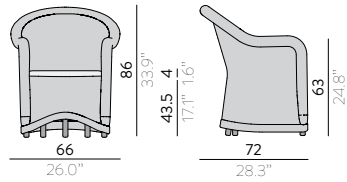

CORD WING CHAIR / FS-CH23

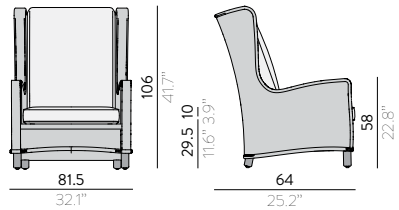

CORD 1S / FS-1S35

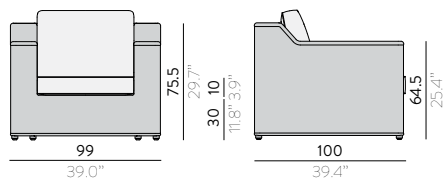

CORD 2.5S / FS-2S96

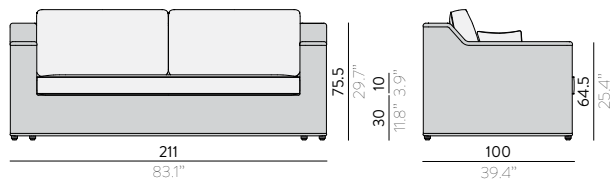

CORD LEFT SEAT / FS-SDL5

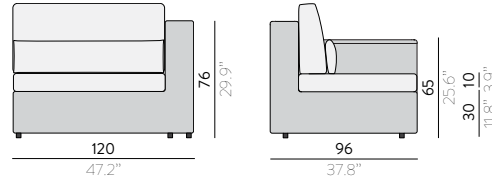

CORD RIGHT SEAT / FS-SDRS

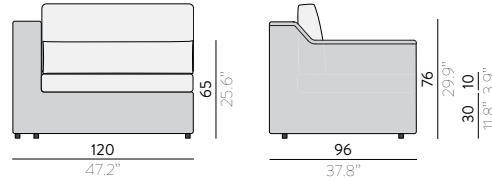

CORD CORNER / FS-SDCS

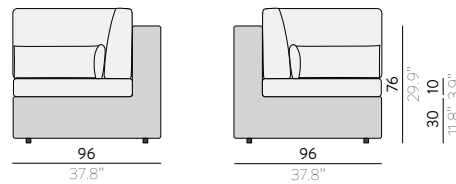

CORD SMALL MIDDLE SEAT / FS-SDMSS

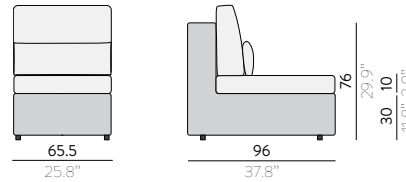

CORD LARGE MIDDLE SEAT / FS-SDMSL

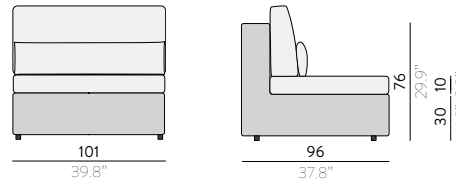

CORD SMALL FOOTSTOOL / SIDETABLE / FS-FR80S

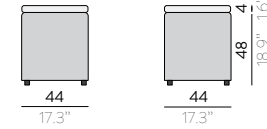

CORD MEDIUM FOOTSTOOL / SIDETABLE / FS-FR80M

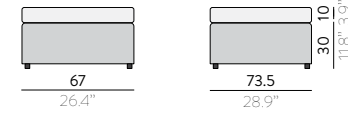

CORD LARGE FOOTSTOOL / SIDETABLE / FS-SDFL

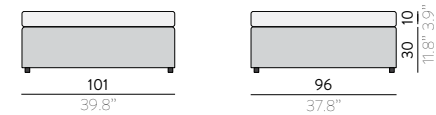

CORD LOUNGER / FS-SDLO

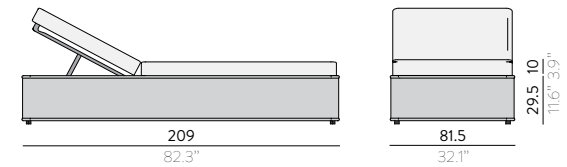

MALIBU collection

Designed by Manutti Design Studio



Materials & colours

FINISHING
wicker 2,8mm



23
camel

Cushions

Suggested colour combo - see back cover (flap)

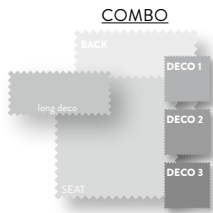

A2 - B20

No options

CORD SQUARE CHAIR / FS-CH18

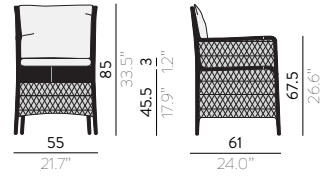

CORD SQUARE 1S / FS-1S36

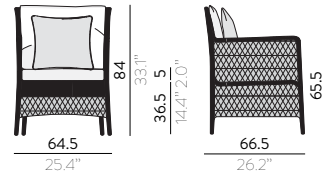

CORD SQUARE 2.5S / FS-2S97

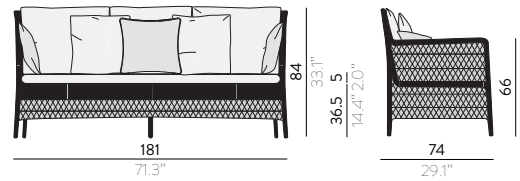

CORD SQUARE PATIO CHAIR / FS-LO49

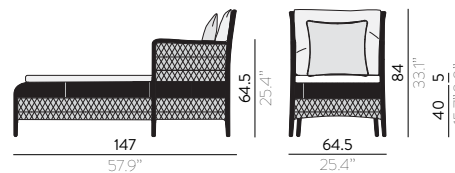

CORD SQUARE COFFEE TABLE / FS-CT83



CORD SQUARE MEDIUM FOOTSTOOL /
SIDETABLE / FS-FR81

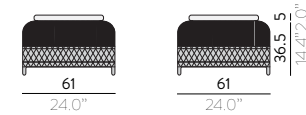

CORD SQUARE SIDETABLE / FS-CT84

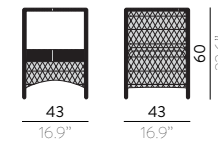

ST TROPEZ collection

Designed by Manutti Design Studio

VERSAILLES collection

Designed by Manutti Design Studio



Materials & colours

FRAME

wrought iron + chromatisation



89
anthracite

Cushions



cushion
with piping

Options



teak arm

DINING CHAIR / FS-ACS-10

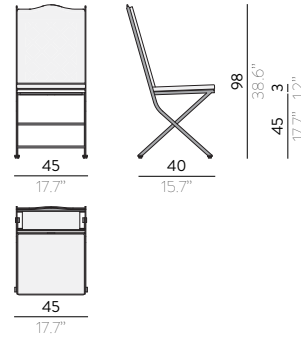

CHAIR / FS-ACS-20

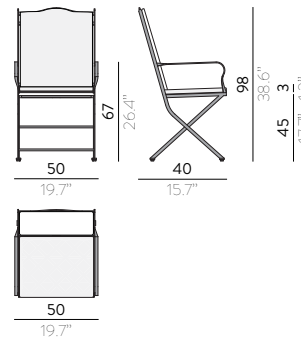

Materials & colours

FRAME

wrought iron + chromatisation



89
anthracite



F8
white

Cushions



cushion
with piping

Options



teak arm

DINING CHAIR / FS-ACV-10

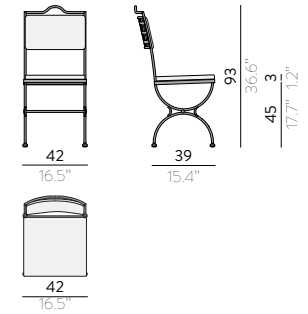

CHAIR / FS-ACV-20

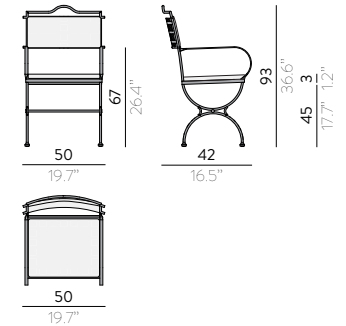

Technical specifications Tables & Accessories

Measurements,
materials & options





MINUS tables

Designed by Manutti Design Studio



Features



table top in 1 piece
with 5 parts simulation

Options



PROTECTIVE COVER

Materials & colours

FRAME PCA

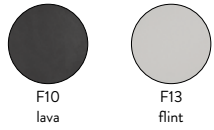
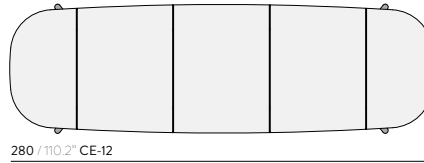

TABLE TOP CE - ceramic 12mm



DINING TABLE



TORSA tables

Designed by Manutti Design Studio



Features



oval shaped ceramic table top with rounded corners

Options



protective cover

Materials & colours

FRAME

teak



T
teak



TN
brushed teak
nero

TABLE TOP

CE - ceramic 6mm (only for rectangular table)



60 - CEW
white



64 - CEQ
quartz



66 - CEL
perla

CE - ceramic 12mm



53 - CEF
fossil



54 - CET
travertin geo



57 - CEK
basalt black



58 - CEMW
marble white



59 - CEMB
marble black

DINING TABLE

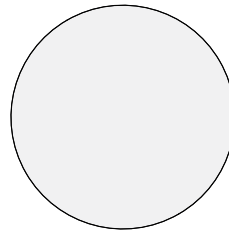

148 / 58.3" CE-12

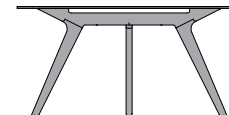

148 / 58.3"

73 / 28.7"



264 / 103.9" CE-6 / CE-12

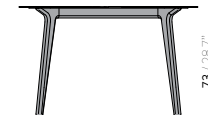

118 / 46.5"

73 / 28.7"

COFFEE TABLE

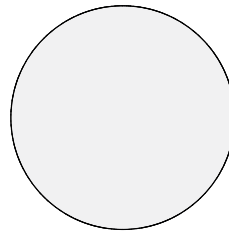

148 / 58.3" CE-12

100 / 39.4" CE-12



148 / 58.3"

100 / 39.4"

29.2 / 11.5"

BISTRO TABLE

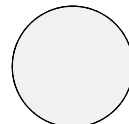

80 / 31.5" CE-12

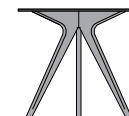

80 / 31.5"

73 / 28.7"

AIR tables

Designed by Manutti Design Studio



Features



special saw-cut
iroko table top



oval shaped ceramic
table top with
rounded corners

Materials & colours

FRAME PWI



TABLE TOP

IR - iroko



48 - IR
iroko

CE - ceramic 6mm



60 - CEW
white

64 - CEQ
quartz

66 - CEL
perla

CE - ceramic 12mm



53 - CEF
fossil

54 - CET
travertin geo

57 - CEK
basalt black

58 - CEMW
marble white

59 - CEMB
marble black

DINING TABLE

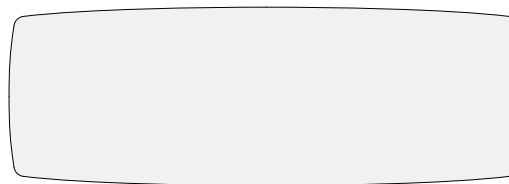

340 / 133.9" IR / CEQ



113 / 44.5"



ceramic

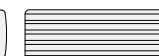

iroko slates



264 / 103.9" IR / CE-6 / CE-12

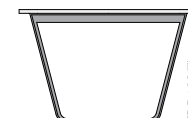

113 / 44.5"



ceramic



iroko slates

PRATO tables

Designed by Manutti Design Studio



Materials & colours

FRAME
PWI



TABLE TOP

AT - teak 35mm

CE - ceramic 6mm



CE - ceramic 12mm

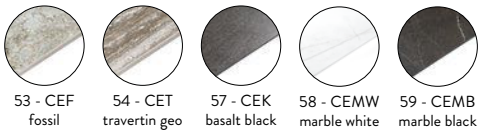

GL - acid etched glass 10mm

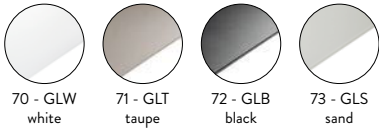

DINING TABLE



270 / 106.3" AT / CE-12 / GL

215 / 84.6" GL

107 / 42.1"

75 / 29.5"

COFFEE TABLE



180 / 70.9" AT / CE-12 / GL

150 / 59.1" CE-6 / GL

90 / 35.4"

35 / 13.8"

BENCH

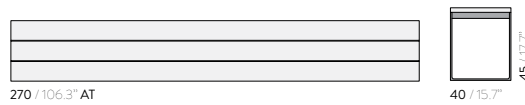

270 / 106.3" AT

40 / 15.7"

45 / 17.7"

FUSE tables

Designed by Manutti Design Studio



Options



PROTECTIVE COVER
only for Trespa®/glass/ceramic
table tops

Materials & colours

FRAME PCA



TABLE TOP

TL - teak 35mm

CE - ceramic 6mm



CE - ceramic 12mm

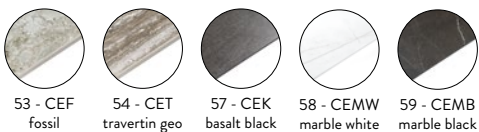

GL - acid etched glass 10mm

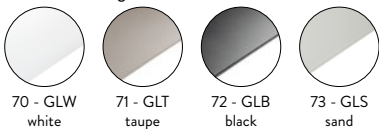

TR - Trespa® 10mm



DINING TABLE



300 / 118.1" CE-6 / GL / TR

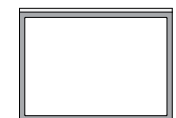

100 / 39.4"

75 / 29.5"

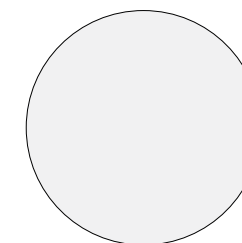

148 / 58.3" TL / CE-12 / GL

130 / 51.2" TL / GL

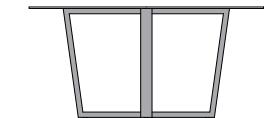

148 / 58.3"

130 / 51.2"

75 / 29.5"

BENCH 300

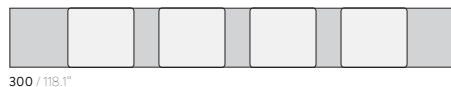

300 / 118.1"

with full alu top

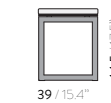

39 / 15.4"

44.5 / 17.5"

BENCH 45



45 / 17.7"

with full alu top



39 / 15.4"

44.5 / 17.5"

LUNA tables

Designed by Manutti Design Studio



Features



LED-LIGHTING
set includes battery,
charger and remote
control



easy sliding system for
extendible function

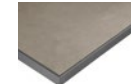

integrated table top

Options



PROTECTIVE COVER
only for Trespa®/glass/ceramic
table tops

Materials & colours

FRAME PCA

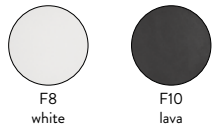

F8
white

F10
lava

TABLE TOP

CE - ceramic 6mm

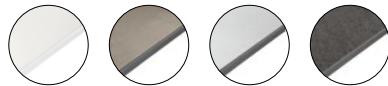

60 - CEW
white

64 - CEQ
quartz

66 - CEL
perla

67 - CEK
basalt black

GL - acid etched glass 10mm

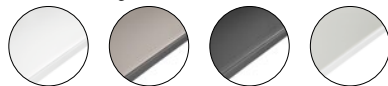

70 - GLW
white

71 - GLT
taupe

72 - GLB
black

73 - GLS
sand

TR - Trespa® 10mm



90 - TRW
white

92 - TRB
black

EXTENDIBLE DINING TABLE

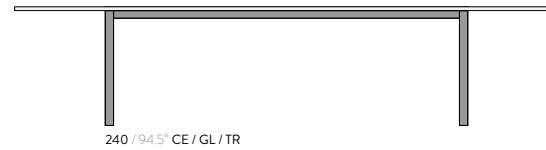

240 / 94.5" CE / GL / TR

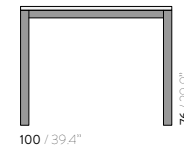

100 / 39.4"

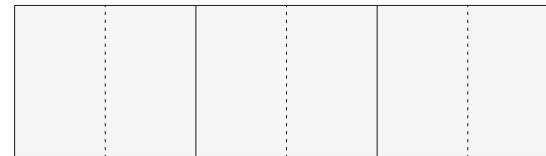

360 / 142"

open dimensions

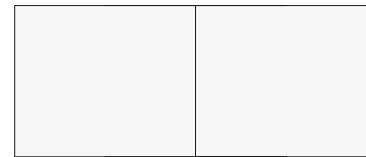

240 / 94.5"

closed dimensions

TRENTO tables

Designed by Manutti Design Studio

Features



2 wheels for easy moving
(not for low dining table)

Options



PROTECTIVE COVER
only for Trespa®/glass/ceramic
table tops



Materials & colours

FRAME PCA



TABLE TOP

TL - teak 35mm

CE - ceramic 6mm



GL - acid etched glass 10mm

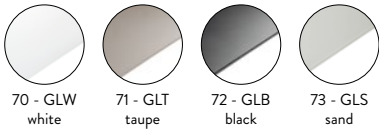

TR - Trespa® 13mm

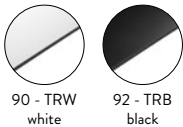

DINING TABLE

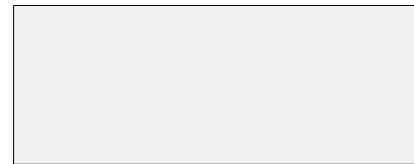

270 / 106.3" CE-6 / GL
215 / 84.6" TL / CE-6 / GL
150 / 59.1" TL / CE-6 / GL / TR



105 / 41.3"

90 / 35.4"



105 / 41.3" CE-6 / GL

90 / 35.4" TL / CE-6 / GL / TR



105 / 41.3"

90 / 35.4"

COFFEE TABLE

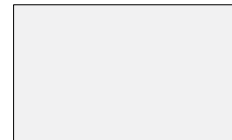

150 / 59.1" TL / CE-6 / GL / TR



90 / 35.4"



105 / 41.3" CE-6 / GL

90 / 35.4" TL / CE-6 / GL / TR



105 / 41.3"

90 / 35.4"

BENCH



190 / 74.8" TR
125 / 49.2" TR



39 / 15.4"

QUARTO tables

Designed by Manutti Design Studio



Options



PROTECTIVE COVER
only for Trespa®/glass/ceramic
table tops

Materials & colours

FRAME PCA

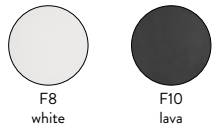

F8
white

F10
lava

TABLE TOP

TL - teak 35mm CE - ceramic 6mm



43 - TL
teak slates

60 - CEW
white

64 - CEQ
quartz

66 - CEL
perla

67 - CEK
basalt black

GL - acid etched glass 10mm

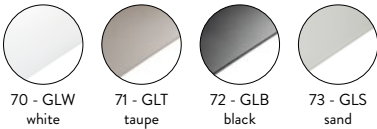

70 - GLW
white

71 - GLT
taupe

72 - GLB
black

73 - GLS
sand

TR - Trespa® 13mm



90 - TRW
white

92 - TRB
black

BAR TABLE

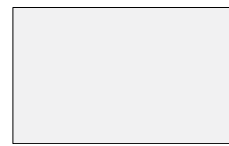

150 / 59.1" TL / CE-6 / GL / TR
130 / 51.2" TL / CE-6 / GL / TR

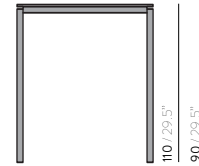

90 / 35.4"
75 / 29.5"

110 / 29.5"
90 / 29.5"



105 / 41.3" CE-6 / GL
90 / 35.4" TL / CE-6 / GL / TR
75 / 29.5" TL / CE-6 / GL / TR

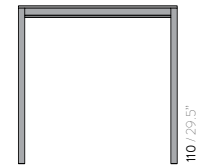

105 / 41.3"
90 / 35.4"
75 / 29.5"

110 / 29.5"
90 / 29.5"

DINING TABLE



270 / 106.3" CE-6 / GL
215 / 84.6" TL / CE-6 / GL
150 / 59.1" TL / CE-6 / GL / TR
130 / 51.2" TL / CE-6 / GL / TR



105 / 41.3"
90 / 35.4"
75 / 29.5"

75 / 29.5"
65 / 29.5"



105 / 41.3" CE-6 / GL
90 / 35.4" TL / CE-6 / GL / TR
75 / 29.5" TL / CE-6 / GL / TR

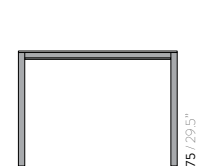

105 / 41.3"
90 / 35.4"
75 / 29.5"

75 / 29.5"
65 / 29.5"

COFFEE & LOUNGE TABLE



150 / 59.1" TL / CE-6 / GL / TR
130 / 51.2" TL / CE-6 / GL / TR



90 / 35.4"
75 / 29.5"

35 / 29.5"
18 / 29.5"



105 / 41.3" CE-6 / GL
90 / 35.4" TL / CE-6 / GL / TR
75 / 29.5" TL / CE-6 / GL / TR

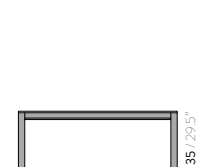

105 / 41.3"
90 / 35.4"
75 / 29.5"

35 / 29.5"
18 / 29.5"

FOOTSTOOL/ SIDETABLE

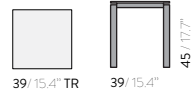

39 / 15.4" TR

39 / 15.4"

45 / 17.7"

SIENA tables

Designed by Manutti Design Studio



Tabletops

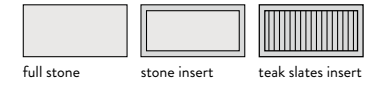

Materials & colours

FRAME

teak



T
teak

TABLE TOP

FULL STONE TABLE TOP

bluestone 30mm

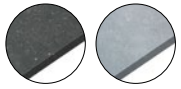

00 - BD dark
00 - BL light

satingo 30mm striped border

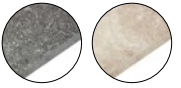

01 - SB blue
01 - SS sand

granite 30mm



06 - GC caramel

satingo 20mm



09 - SN nero

TEAK BORDER + INSERT

bluestone 20mm

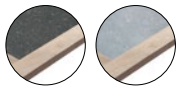

40 - BD dark
40 - BL light

satingo 20mm



41 - SB blue
41 - SS sand

granite 20mm



46 - GC caramel

satingo 20mm



49 - SN nero

teak 35mm



43 - TL teak slates

DINING TABLES



180 / 70.9"

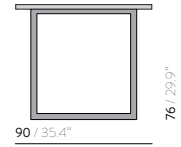

90 / 35.4"

76 / 29.9"

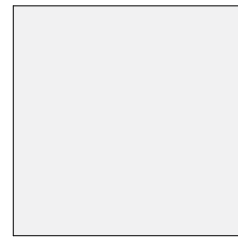

152 / 59.8"
120 / 47.2"

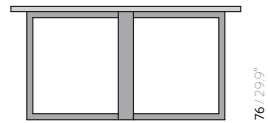

152 / 59.8"
120 / 47.2"

76 / 29.9"

120x120 only with full stone

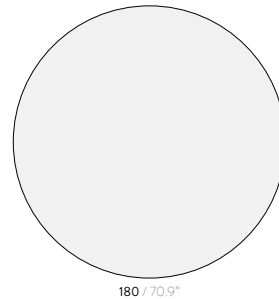

180 / 70.9"
155 / 61.0"
130 / 51.2"

ø180 and ø155 no full stone

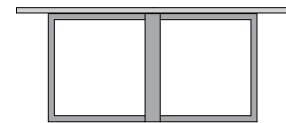

180 / 70.9"
155 / 61.0"
130 / 51.2"

76 / 29.9"

COFFEE TABLES

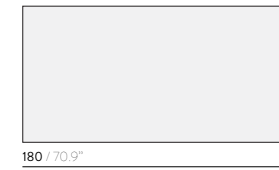

180 / 70.9"



90 / 35.4"

35 / 13.8"



152 / 59.8"
120 / 47.2"

120x120 only with full stone

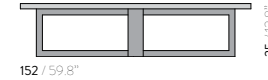

152 / 59.8"
120 / 47.2"

35 / 13.8"

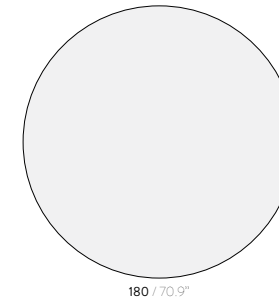

180 / 70.9"
155 / 61.0"
130 / 51.2"

ø180 and ø155 no full stone

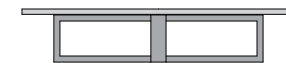

180 / 70.9"
155 / 61.0"
130 / 51.2"

35 / 13.8"

LIVORNO tables

Designed by Manutti Design Studio



Tabletops

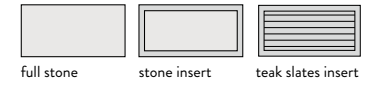

Materials & colours

FRAME

teak



T
teak

TABLE TOP

FULL STONE TABLE TOP

bluestone 30mm granite 30mm satino 30mm striped border satino 20mm

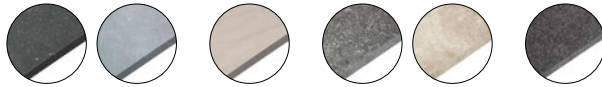

00 - BD dark
00 - BL light
06 - GC caramel
01 - SB blue
01 - SS sand
09 - SN nero

FULL STONE TABLE TOP WITH PARROT'S BILL

bluestone 30mm satino 30mm



60 - BD dark
60 - BL light
61 - SB blue
61 - SS sand

TEAK BORDER + INSERT

bluestone 20mm granite 20mm satino 20mm satino 20mm

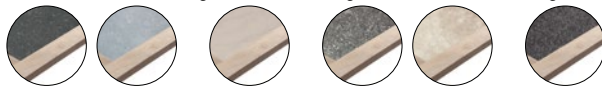

40 - BD dark
40 - BL light
46 - GC caramel
41 - SB blue
41 - SS sand
49 - SN nero

teak 35mm



43 - TL
teak slates

DINING TABLE

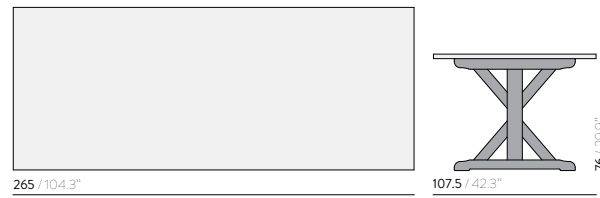

MILANO tables

Designed by Manutti Design Studio



Materials & colours

FRAME

teak



T
teak

TABLE TOP

TEAK BORDER + INSERT

bluestone 20mm



40 - BD
dark



40 - BL
light

granite 20mm



46 - GC
caramel



41 - SB
blue



41 - SS
sand

satingo 20mm



49 - SN
nero

teak 35mm



43 - TL
teak slates

EXTENDIBLE DINING TABLE

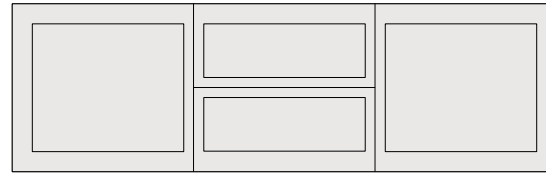
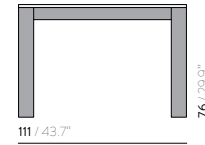

360 / 142

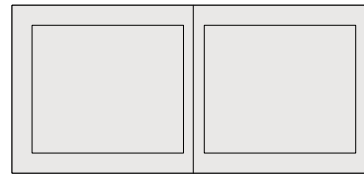

240 / 94.5"

closed dimensions

Tabletops

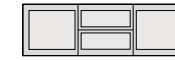

stone insert

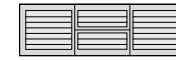

teak slates insert

CAPRI tables

Designed by Manutti Design Studio



Materials & colours

FRAME

wrought iron



TABLE TOP

ST - FULL STONE TABLE TOP

bluestone 30mm

granite 30mm

satingo 30mm

satingo 20mm

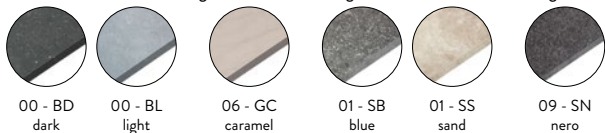

ST - FULL STONE TABLE TOP WITH PARROT'S BILL

bluestone 30mm

satingo 30mm



AT - TEAK TABLE TOP

teak 35mm



Tabletops



full stone



teak slates insert

DINING TABLE

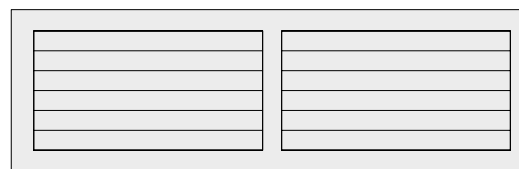

345 / 106.3" AT

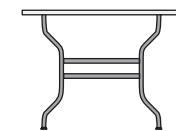

107 / 41.3"

75 / 29.5"



270 / 106.3" ST

240 / 94.5" ST / AT

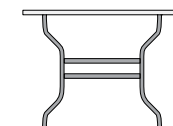

105 / 41.3"

75 / 29.5"



90 / 35.4" ST

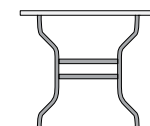

90 / 35.4"

75 / 29.5"

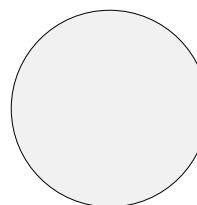

130 / 51.2" ST

90 / 35.4" ST

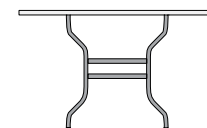

130 / 51.2"

90 / 35.4"

75 / 29.5"

NAPOLI tables

Designed by Manutti Design Studio



Materials & colours

FRAME
PCAF8
whiteF10
lavaF11
shingle

TABLE TOP

TL - teak 20mm

CE - ceramic 6mm with border

43 - TL
teak slates60 - CEW
white64 - CEQ
quartz66 - CEL
perla67 - CEK
basalt black

GL - acid etched glass 10mm with border

70 - GLW
white71 - GLT
taupe72 - GLB
black73 - GLS
sand

TR - Trespa® 13mm

90 - TRW
white92 - TRB
black

Options



PROTECTIVE COVER
only for Trespa®/glass/ceramic
table tops

HIGH
BISTRO
TABLE

WITH BORDER



75 / 29.5" CE-6 / GL
60 / 23.6" CE-6 / GL

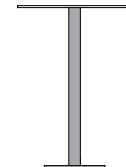

75 / 29.5"
60 / 23.6"

110 / 43.3"

WITHOUT BORDER



90 / 35.4" TL / TR
75 / 29.5" TL / TR
60 / 23.6" TR

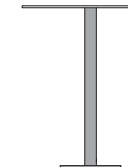

90 / 35.4"
75 / 29.5"
60 / 23.6"

110 / 43.3"

WITHOUT BORDER

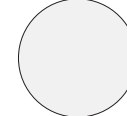

80 / 31.5" TL / TR

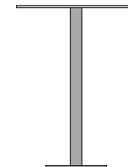

80 / 31.5"

110 / 43.3"

BISTRO
TABLE

WITH BORDER



75 / 29.5" CE-6 / GL
60 / 23.6" CE-6 / GL

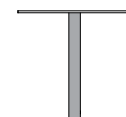

75 / 29.5"
60 / 23.6"

74.5 / 29.3"

WITHOUT BORDER

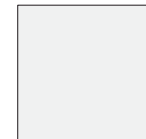

90 / 35.4" TL / TR
75 / 29.5" TL / TR
60 / 23.6" TR

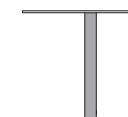

90 / 35.4"
75 / 29.5"
60 / 23.6"

74.5 / 29.3"

WITHOUT BORDER

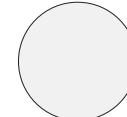

80 / 31.5" TL / TR

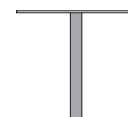

80 / 31.5"

74.5 / 29.3"



Options



protective cover

Materials & colours

FRAME
PCSTS



F8
white

F10
lava

F13
flint

TABLE TOP

IR - iroko



IR
iroko

CE - ceramic 6mm



60 - CEW
white

64 - CEQ
quartz

66 - CEL
perla

CE - ceramic 12mm



53 - CEF
fossil

54 - CET
travertin geo

57 - CEK
basalt black

58 - CEMW
marble white

59 - CEMB
marble black

GL - acid etched glass 10mm

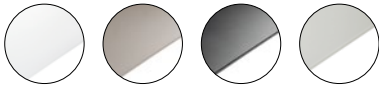

70 - GLW
white

71 - GLT
taupe

72 - GLB
black

73 - GLS
sand

TR - Trespa® 13mm



90 - TRW
white

92 - TRB
black

LOUNGE
TABLE

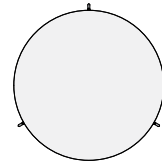

100 / 39.4" IR / CE-6 / CE-12 / GL / TR
80 / 31.5" IR / CE-6 / CE-12 / GL / TR



100 / 39.4"
80 / 31.5"

32.5 / 12.8"
27.5 / 10.8"

COFFEE
TABLE

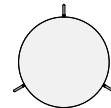

60 / 23.6" IR / CE-6 / CE-12 / GL / TR
42 / 16.5" IR / CE-6 / CE-12 / GL / TR

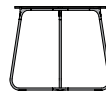

60 / 23.6"
42 / 16.5"

55.5 / 21.9"
44.5 / 17.5"

OUTDOOR SIDE TABLES

Designed by Manutti Design Studio



Materials & colours

FRAME + TABLE TOP
PCA

TABLE TOP (ONLY FOR ROUND 42)

iroko

IR
iroko

CLOSED 36 / FS-ST01

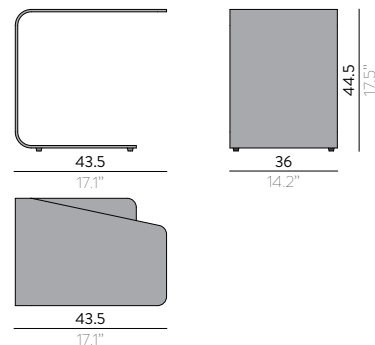

OPEN 32 / FS-ST02

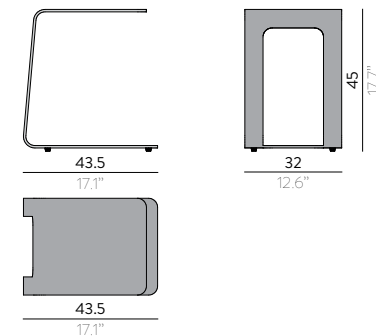

ROUND 48 / FS-ST03

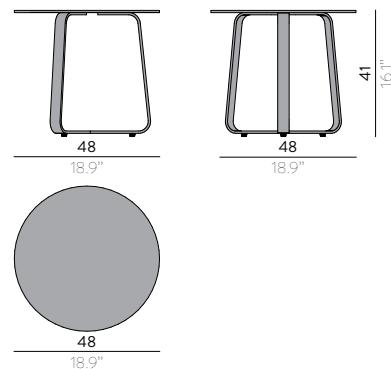

ROUND 42 / FS-ST05

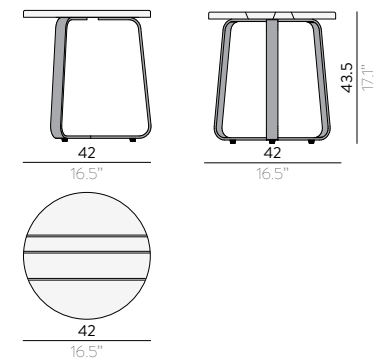

VITRAL 80 (SET OF 2) / FS-ST04-38

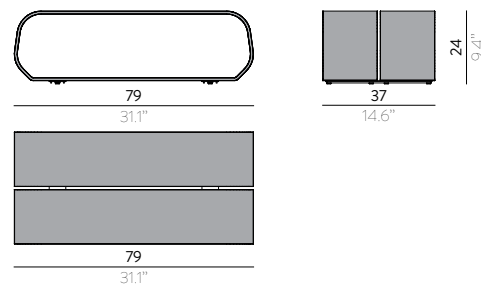

VITRAL 80 (SET OF 3) / FS-ST04-58

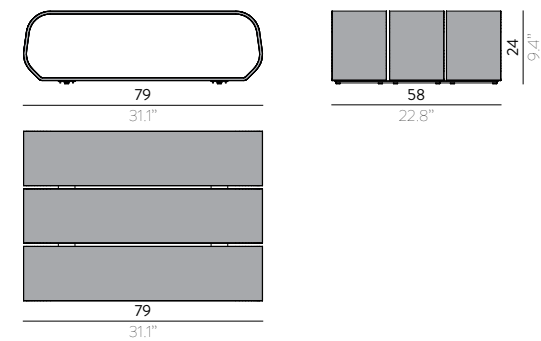

TRAYS



Materials & colours

BASE - FRAME
PCA

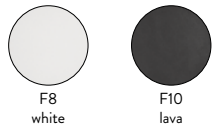

TRAY 48X48 / FS-TRAY48X48

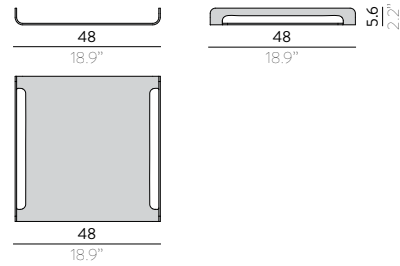

TRAY 60X28 / FS-TRAY60X28

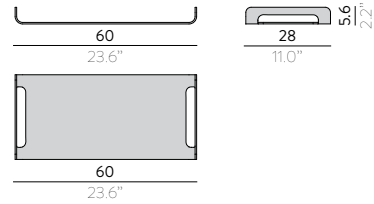

TOWEL RACK

Designed by Manutti Design Studio



Materials & colours

FRAME
teak



TEAK TOWEL RACK / FS-TKTR01

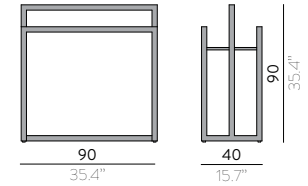

POUFS

TOUCH



FINISHING
all fabrics

TOUCH 112X65 / FS-THPF112

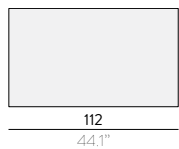
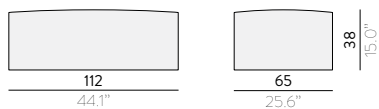

TOUCH Ø82 / FS-THPF82

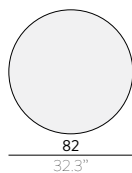
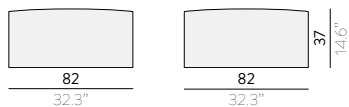

TOUCH Ø52 / FS-THPF52

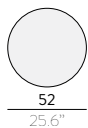
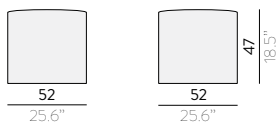

MOON ISLAND



FINISHING
all fabrics

MOON ISLAND POUF 52 / FS-MIFS52

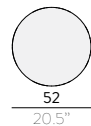
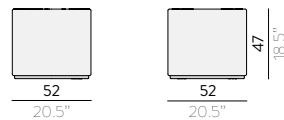

MOON ISLAND POUF 63 / FS-MIFS63

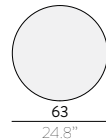
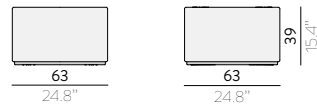

KUMO



FINISHING
all fabrics

KUMO POUF 50 / FS-KOPF50

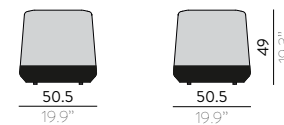

OUTDOOR LIGHTING & CANDLES

Designed by Manutti Design Studio



Materials & colours

FRAME - FINISHING

PCA - iroko



Features



scented candle

FLAME CANDLE SMALL / FS-CDL-S

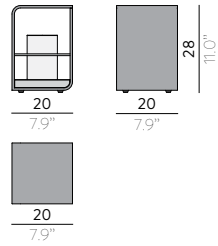

FLAME CANDLE MEDIUM / FS-CDL-M

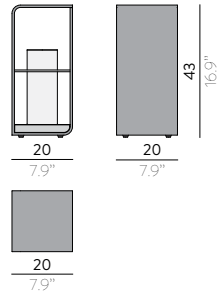

FLAME CANDLE LARGE / FS-CDL-L

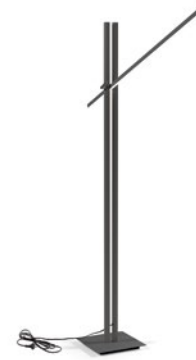
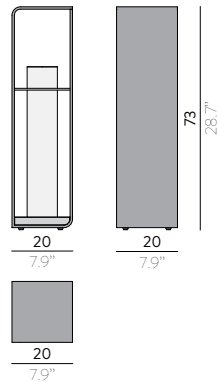

Materials & colours

BASE - FRAME

PCA



TWILIGHT / FS-LA04

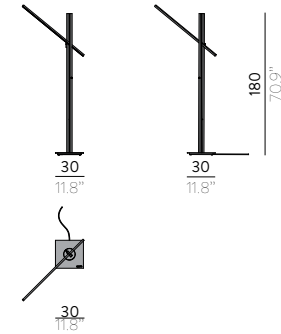

UMBRELLAS

Designed by Manutti Design Studio



UMBRELLA Materials & colours FRAME

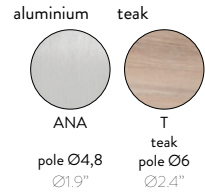

BASE Materials & colours FRAME



FINISHING - fabrics

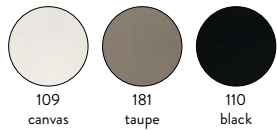

Features Umbrella



mechanism in anodised aluminium



mechanism in anodised aluminium



protective cover included

Features Base



with wheels

Options Base



pole protector

SQUARE UMBRELLA 300X300 / CEPAL300X300

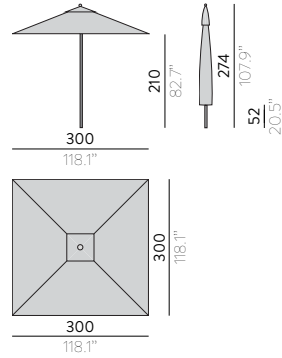

RECTANGULAR UMBRELLA 300X400 / CEPAL300X400

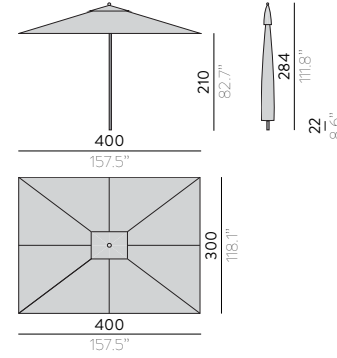

ROUND UMBRELLA Ø350 / CEPAL350XR

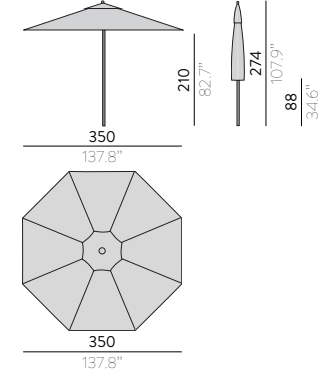

STONE BASE 55KG / UBAG55

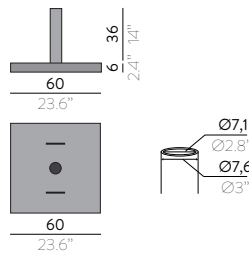

STONE BASE 80KG WITH WHEELS / UBAGB80W

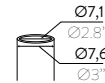
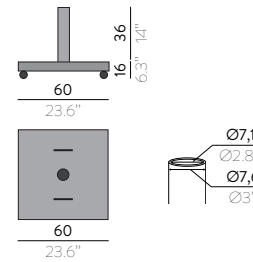

UMBRELLAS

Designed by Manutti Design Studio



Materials & colours

FRAME

aluminium PCA

ANA	F8	F7
pole Ø3,9	white	black
Ø1.54"	pole Ø3,9	pole Ø3,9
	Ø1.54"	Ø1.54"

FINISHING - fabrics

standard

109	181	110
canvas	taupe	black

selected fabrics

45	44	46	47	48	42
oliva	forest	denim	cherry	mineral	rock

Features



mechanism in anodised aluminium



protective cover included

SMALL ALUMINIUM UMBRELLA (4 RIBS) 180X180 / SCP-180X180

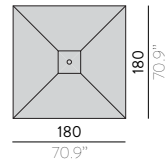
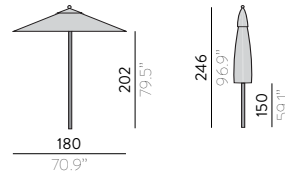

IRON BASE 21KG / UBAIB25

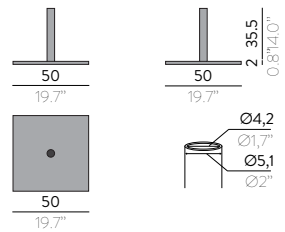

RUGS

Designed by Manutti Design Studio

STEPS



Materials & colours

FINISHING

70%polypropylene, 10% polyester, 20% viscose



M413
aqua



M480
silver

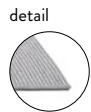

detail



400 / 157.5"

300 / 118.1"

260 / 102.4"

200 / 78.7"

LINEAR



Materials & colours

FINISHING

polyolefin



M514
pepper



M513
anthracite



detail



350 / 137.8"

290 / 114.2"

230 / 90.6"

250 / 98.4"

200 / 78.7"

170 / 66.9"

TWIST



Materials & colours

FINISHING

textylene



TS12
silver



TS11
bronze



detail



350 / 137.8"

290 / 114.2"

230 / 90.6"

250 / 98.4"

200 / 78.7"

170 / 66.9"



CORD CUSHION BOX SMALL / FS-CCCBS

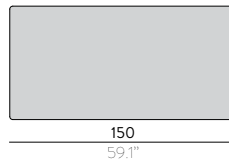
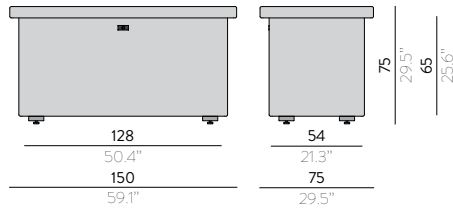

Materials & colours

FINISHING

wicker 2mm

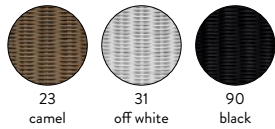

Features



cushion boxes can be locked

CORD CUSHION BOX LARGE / FS-CCCBL

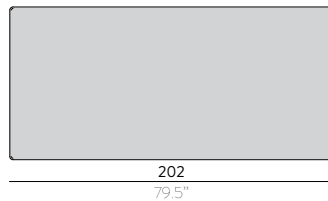
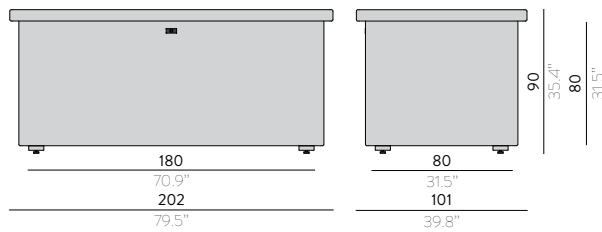

Materials & colours

FINISHING

PCA

teak

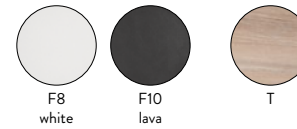

Features



cushion boxes can be locked (except for teak cushion box)

PCA CUSHION BOX LARGE / FS-FECBL

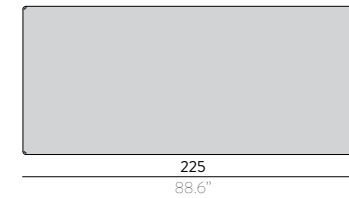
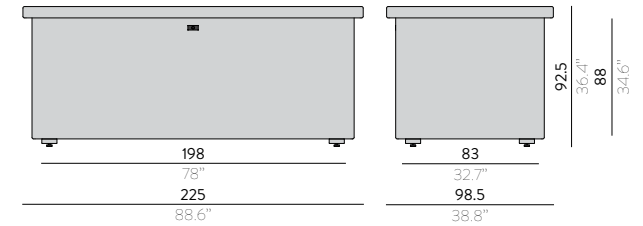

TEAK CUSHION BOX LARGE / FS-TKCB01

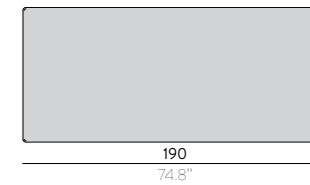
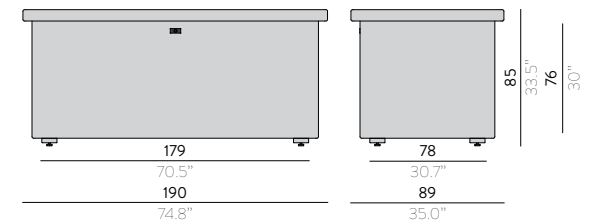

Materials and fabrics

Technical specifications
of fabrics and materials
used for frames,
finishings, table tops
and cushions





MATERIALS

POWDER COATED ALUMINIUM (PCA)

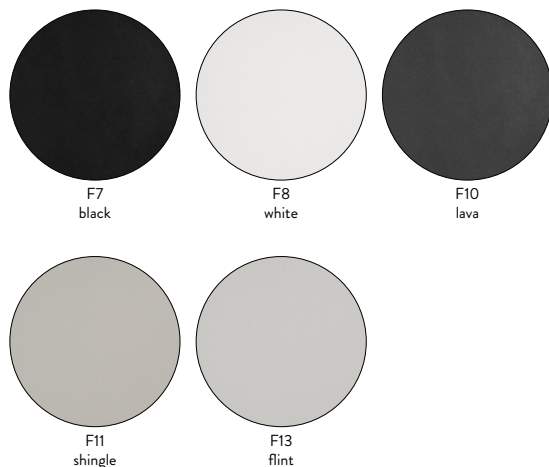

POWDER COATED ALUMINIUM

- Fluidised powder coating applied to the aluminium structure by electrostatic spray. To ensure the solidity and resistance of the powder coating, the whole thing is stoved at a temperature of between 160°C (320°F) and 210°C (410°F) (T° according to type of powder)
- Easy to clean and maintain (for specific maintenance see p. 346)
- For outdoor and indoor use

GEPOEDERLAKT ALUMINIUM

- Deklaag van gefluidiseerd poeder, aangebracht door elektrostatisch spuiten op de aluminium structuur; om een stevige en duurzame deklaag te verwezenlijken, is het geheel gebakken in de oven op een temperatuur tussen 160°C (320°F) en 210°C (410°F) (naargelang het poedertype)
- Gemakkelijke reiniging en onderhoud (voor een specifiek onderhoud zie p. 346)
- Voor gebruik buiten en binnen

ALUMINIUM THERMOLAQUE

- Poudre powder coating fluidisée appliquée par spray électrostatique sur la structure en aluminium. pour obtenir le solide et la résistance du revêtement powder coating, l'ensemble est cuit au four à une température entre 160°C (320°F) et 210°C (410°F) (T° selon type poudre)
- Nettoyage et entretien facile, pour un entretien spécifique (voir p. 346)
- Pour une utilisation en extérieur et intérieur

PULVERBESCHICHTETES ALUMINIUM

- Beschichtung mit verflüssigtem Pulver, das im elektrostatischen Sprayverfahren auf das Aluminiumgestell aufgetragen wird. Zur Erreichung einer festen und widerstandsfähigen Pulverbeschichtung erfolgt anschließend eine Härtung im Ofen bei einer Temperatur zwischen 160°C (320°F) und 210°C (410°F) (Dauer in Abhängigkeit vom Pulvertyp)
- Einfache Reinigung und Pflege (spezielle Pflege siehe S. 346)
- Für die Verwendung im Außen- und Innenbereich

ALUMINIO CON REVESTIMIENTO EN POLVO

- Revestimiento en polvo licuado aplicado mediante pulverizador electrostático sobre la estructura de aluminio. Para adquirir la solidez y resistencia del revestimiento en polvo, el conjunto se mete en horno a una temperatura de entre 160°C (320°F) y 210°C (410°F) (en función del tipo de polvo)
- Fácil limpieza y mantenimiento, para un mantenimiento específico (consulte p. 346)
- Utilizable al aire libre y en interiores

ALLUMINIO TERMOLACCATO

- Polvere powder coating fluidificata applicata mediante spray elettrostatico sulla struttura in alluminio. Per ottenere la solidità e la resistenza del rivestimento powder coating, il tutto viene cotto al forno a una temperatura compresa tra i 160°C (320°F) e i 210°C (410°F) (in base al tipo di polvere)
- Facile pulizia e manutenzione, per una manutenzione specifica vedere p. 346
- Per un utilizzo in ambienti esterni ed interni

ANODISED ALUMINIUM (ANA)

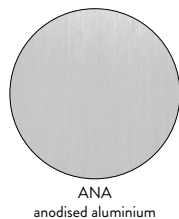

ANODISED ALUMINIUM

- Electrochemical surface treatment on aluminium
- Protects the aluminium from mechanical wear and tear, chemical attack and corrosion
- Micron content: 27 MICRON oxide layer with open pores and a well-determined layer thickness formed
- Recommended near the sea, a swimming pool, in very industrial areas, or near a railway
- For outdoor and indoor use
- Does not require any specific maintenance, easy to clean

GEANODISEERD ALUMINIUM

- Electrochemische oppervlaktebehandeling op aluminium
- Beschermt het aluminium tegen mechanische slijtage, chemische aantasting en corrosie
- Microngehalte : 27 MICRON oxidelaag met open poriën en een welbepaalde laagdikte gevormd
- Aanbevolen in de buurt van de zee, zwembaden, in de buurt van zware industrie, spoorwegen
- Voor gebruik buiten en binnen
- Gemakkelijke reiniging en onderhoud

ALUMINIUM ANODISÉ

- Traitement de surface électrochimique sur aluminium
- protège l'aluminium contre l'usure mécanique, l'érosion chimique et la corrosion
- Microns : couche d'oxydation de 27 MICRONS avec pores ouverts et une épaisseur de couche formée suivant des spécifications déterminées
- Préconisé a proximité de la mer, piscine, dans des zones fortement industrielle, voie ferrée
- Pour une utilisation extérieure et intérieure
- ne demande aucun entretien spécifique, nettoyage facile

ELOXIERTES ALUMINIUM

- Elektrochemische Oberflächenbehandlung von Aluminium
- Schützt Aluminium vor mechanischem Verschleiß, dem Angriff durch Chemikalien und Korrosion
- Mikroanteil: 27 MICRON offeneporige Oxidschicht und mit genau definierter Schichtdicke
- Empfohlen in der Umgebung des Meeres, eines Schwimmbades, in Gebieten mit hoher Industriekonzentration und in Eisenbahnnähe
- Für Außen- und Innenverwendung
- Ohne spezielle Wartungsanforderungen, problemlose Reinigung

ALUMINIO ANODIZADO

- Tratamiento electroquímico de la superficie de aluminio
- Protege el aluminio del desgaste mecánico, de daños por productos químicos y de la corrosión
- Valor en micrones: capa de óxido de 27 micrones con poros abiertos y un determinado grosor de capa formado
- Se recomienda si se va a utilizar cerca del mar, de una piscina, de la vía férrea o en zonas industriales
- Para uso en exteriores y interiores
- No precisa mantenimiento específico, de fácil limpieza

ALLUMINIO ANODIZZATO

- Trattamento elettrochimico superficiale dell'alluminio
- Protegge l'alluminio dall'usura meccanica, dal deterioramento chimico e dalla corrosione
- Spessore in micron: pellicola di ossido di 27 MICRON con pori aperti e spessore dello strato definito
- Si consiglia di adottarlo nelle aree vicino al mare, a piscine, nelle aree altamente industriali e vicino alle ferrovie
- Per uso in ambienti esterni ed interni
- Non richiede alcuna manutenzione specifica, facile pulizia

STAINLESS STEEL (PCSTS)

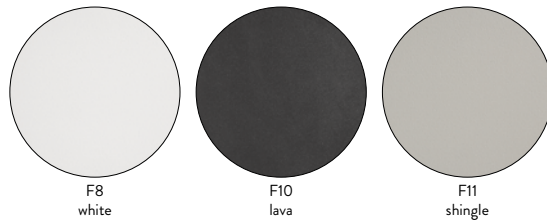

ELECTROPOLISHED STAINLESS STEEL

- Stainless steel 316L and 304L that has been treated. This special treatment draws chrome and nickel and other materials present in steel to the surface, hence giving a brilliant appearance and providing an additional protective coating
- Technique used in the naval industry
- Recommended near the sea, a swimming pool, in very industrial areas, or near a railway
- For outdoor and indoor use

BEHANDELD ROESTVRIJ STAAL

- Behandeld roestvrij staal 316L en 304L. Deze specifieke behandeling zorgt voor een grotere concentratie aan chroom en nikkel en andere legeringselementen bij het oppervlak van het staal zodat het een extra glanzende bescherm laag krijgt
- Techniek gebruikt in de scheepvaartindustrie
- Aanbevolen in de buurt van de zee, zwembaden, in de buurt van zware industrie, spoorwegen
- Voor gebruik buiten en binnen

ACIER INOXYDABLE TRAITÉ

- Acier inoxydable 316L et 304L, ayant subi un traitement. Ce traitement spécifique attire le chrome et le nickel et autres matières présentes dans l'acier à la surface donnant ainsi une apparence brillante et apportant une couche protectrice supplémentaire
- Technique utilisée dans l'industrie navale
- Préconisé à proximité de la mer, piscine, dans des zones fortement industrielle, voie ferrée
- Pour une utilisation en extérieur et intérieur

BEHANDELTER EDELSTAHL

- Behandelter Edelstahl 316L und 304L. Bei dieser speziellen Behandlung werden Chrom, Nickel und andere Legierungselemente an der Oberfläche konzentriert, wodurch die Oberfläche einen besonderen Glanz erhält und eine zusätzliche Schutzschicht gebildet wird
- Diese Technik kommt aus dem Schiffsbau
- Empfohlen in der Umgebung des Meeres, eines Schwimmbades, in Gebieten mit hoher Industriekonzentration und in Eisenbahnnähe
- Für die Verwendung im Außen- und Innenbereich

ACERO ELECTROPULIDO

- Acero inoxidable 316L y 304L, sometido a un tratamiento. Este tratamiento específico atrae al cromo, el níquel y otros materiales presentes en el acero hacia la superficie, lo que hace que ésta tenga una apariencia brillante y proporciona una capa adicional de protección
- Técnica utilizada en la industria naval
- Se recomienda si se va a utilizar cerca del mar, de una piscina, de la vía férrea o en zonas industriales
- Utilizable al aire libre y en interiores

ACCIAIO INOSSIDABILE TRATTATO

- Acciaio inossidabile 316L e 304L sottoposto a trattamento. Questo trattamento specifico attira il cromo, il nickel e altri elementi presenti nell'acciaio verso la superficie, creando così un aspetto brillante e generando un'ulteriore strato protettivo
- Tecnica utilizzata nel settore navale
- Si consiglia di adottarlo nelle aree vicino al mare, a piscine, nelle aree altamente industriali e vicino alle ferrovie
- Per un utilizzo in ambienti esterni ed interni

WROUGHT IRON (PWI)

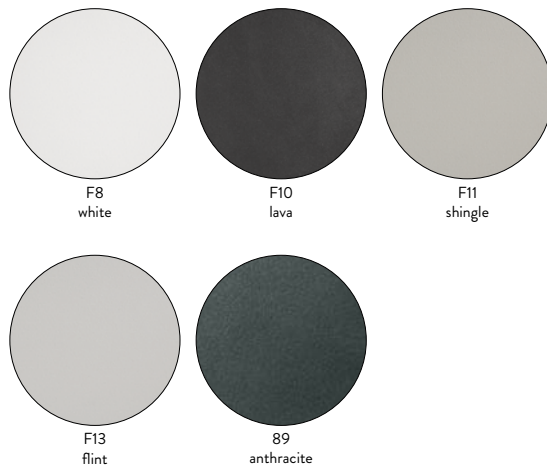

WROUGHT IRON

- Sanded solid forged iron, with anti-oxidation treatment (phosphatation) and stoved at 180°C (356°F) min.
- 100% UV-resistant, does not discolour in the light and sun
- Swimming pool and sea water resistant and repellent
- Does not require any specific maintenance, easy to clean
- For outdoor and indoor use
- Each item of furniture is assembled by hand
- 100% recyclable

SMEEDIJZER

- Massief gezandstraald smeedijzer, behandeld tegen oxidatie (fosfatering) en in de oven gebakken op minstens 180°C (356°F).
- 100% uv-bestendig, verkleurt niet onder invloed van licht en de zon
- Waterafstotend en bestand tegen water van zwembaden en zeewater
- Vergt geen enkel specifiek onderhoud, gemakkelijk schoon te maken
- Voor gebruik buiten en binnen
- Elk meubelstuk wordt met de hand geassembleerd
- 100% recycleerbaar

FER FORGÉ

- Fer forgé massif sablé, traité anti-oxydation (phosphatation) et cuit au four à 180°C (356°F) min.
- 100% résistante aux UV, ne se décolore pas sous l'action de la lumière et du soleil
- Résistant et hydrophobe à l'eau de piscine et de mer
- Ne demande aucun entretien spécifique, nettoyage facile
- Pour une utilisation en extérieur et intérieur
- Chaque mobilier est assemblé manuellement
- 100% recyclable

SCHMIEDEEISEN

- Sandgestrahtes massives Schmiedeeisen, rostschutzbehandelt (Phosphatierung) und im Ofen bei min. 180°C (356°F) gebrannt
- 100 % UV-beständig, bleicht an Licht und Sonne nicht aus
- Wasserabstoßend und schwimmbad- und meerwasserbeständig
- Erfordert keine spezielle Pflege, einfach zu reinigen
- Für die Verwendung im Außen- und Innenbereich
- Jedes Möbelstück wird von Hand zusammengebaut
- 100 % recyclingfähig

HIERRO FORJADO

- Hierro forjado macizo arenado, con tratamiento antioxidación (fosfatación) y cocido al horno a 180°C (356°F) min.
- 100% resistente a los rayos UV, no se decolora por efecto de la luz y del sol
- Resistente e hidrófugo al agua de piscina y de mar
- No requiere tratamiento específico, de fácil limpieza
- Utilizable al aire libre y en interiores
- Cada pieza se monta manualmente
- 100% reciclable

FERRO FORGIATO

- Ferro massiccio forgiato sabbiato, sottoposto a trattamento antiossidante (fosfatazione) e cottura in forno a 180°C (356°F) min.
- Resistente al 100% ai raggi UV, non scolora se esposto a luce o ai raggi solari
- Resistente all'acqua di piscina e di mare, e idrorepellente
- Non richiede alcuna manutenzione specifica, facile pulizia
- Per un utilizzo in ambienti esterni ed interni
- Ogni mobile viene assemblato a mano
- Riciclabile al 100%

MATERIALS

QUARYL® (QUARTZ COMPOSITE)

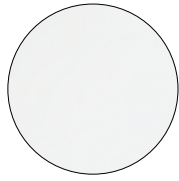

Q8
quaryl®
(only Elements)



- Quartz coloured right through, so absolutely colourfast
- Frost- and UV-resistant making the material highly suitable for outdoor use
- Fully scratch-resistant (more than most other known composites)
- Low porosity and very high density
- Extremely stable and durable
- Ecological and 100% recyclable
- Hygienic: the visible surface is without pores so easy to maintain and clean.

- In de massa gekleurde kwarts en daardoor absoluut kleurecht en kleurvast
- Vorst- en UV-bestendig wat dit materiaal uiterst geschikt maakt voor buitengebruik
- Heel krasbestendig (meer dan de meeste andere gekende composietsoorten)
- Weinig poreus en zeer hoge densiteit
- Uiterst stabiel en duurzaam
- Ecologisch en 100% recycleerbaar
- Hygiënisch: zichtbare oppervlak is porienvrij en hierdoor gemakkelijk te onderhouden en te reinigen.

- Quartz teinté dans la masse et donc totalement inaltérable
- Résistant au gel et aux UV ; ce matériau se prête donc tout à fait à une utilisation extérieure
- Très résistant aux rayures (plus que la plupart des autres types de composites connus)
- Peu poreux et de très haute densité
- Extrêmement stable et durable
- Écologique et recyclable à 100 %
- Hygiénique : la surface visible est exempte de pores et dès lors facile à entretenir et à nettoyer.

- In der Masse gefärbter Quarz und dadurch absolut farbecht und farbfest
- Frost- und UV-beständig, sodass dieses Material besonders geeignet ist zur Verwendung unter freiem Himmel
- Sehr kratzbeständig (mehr als die meisten bekannten Verbundmaterialien)
- Wenig porös und sehr hohe Dichte
- Besonders stabil und haltbar
- Ökologisch und 100% recycelbar
- Hygienisch: Die sichtbare Oberfläche ist porenfrei und dadurch einfach zu warten und zu reinigen.

- Cuarzo coloreado en la masa lo cual garantiza la estabilidad y la solidez del color
- Resistente a las heladas y a UV debido a lo cual este material resulta extremadamente idóneo para usos exteriores
- Muy resistente a los rasguños (más que la mayoría de los otros compuestos conocidos)
- Poco poroso y una muy alta densidad
- Sumamente estable y duradero
- Ecológico y 100% reciclable
- Higiénico: la superficie visible no tiene poros por lo cual resulta fácil de mantener y limpiar.

- Nella massa dei quarzi colorati, quindi assolutamente inalterabile come colore
- Resistente al gelo e ai raggi UV, quindi questo materiale è adattissimo per essere usato all'aperto
- Molto resistente ai graffi (più della maggior parte degli altri tipi di composito conosciuti)
- Scarsa porosità ed elevata densità
- Molto stabile e durevole
- Ecologico e riciclabile al 100%
- Considerazioni igieniche: la superficie visibile è priva di pori e quindi di facile manutenzione e pulizia.



ROPE (R)



R1
bronze
4.5mm



R1
bronze
11mm



R2
silver
4.5mm



R2
silver
11mm

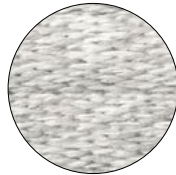

R2
silver
45mm



R3
anthracite
4.5mm



R3
anthracite
11mm

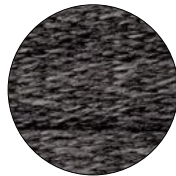

R3
anthracite
45mm



R3
anthracite
45mm



R4
pepper
4.5mm



R4
pepper
45mm

- Blend of Textilene® and polyolefin, UV-resistant
- Swimming pool and sea water resistant and repellent
- Easy to clean and maintain. For specific maintenance, woven & textiles cleaner (see p. 346)
- Each item of furniture is assembled by hand
- Recyclable, GreenGuard certified, REACH certified

- Combinatie van Textilene® en polyolefine, uv-bestendig
- Waterafstotend en bestand tegen water van zwembaden en zeeewater
- Gemakkelijke reiniging en onderhoud, voor specifiek onderhoud woven & textiles cleaner (zie p. 346)
- Elk meubelstuk is met de hand gevlochten
- Recyclebaar, GreenGuard gecertificeerd, REACH gecertificeerd

- Combinaison de Textilene® et polyolefine, resistant aux uv
- Résistante et hydrophobe à l'eau de piscine et de mer
- Nettoyage et entretien facile, pour un entretien spécifique, woven & textiles cleaner (voir p. 346)
- Chaque mobilier est tressé à la main
- Recyclable, GreenGuard certifié, REACH certifié

- Kombination von Textilene® und Polyolefin, UV-beständig
- Wasserabstoßend und Chlor- und Salzwasserbeständig
- Einfache Reinigung und Pflege; für die spezielle Pflege woven & textile cleaner (siehe S. 346)
- Jedes Möbelstück ist von Hand geflochten
- Recyclingfähig, GreenGuard Zertifiziert, REACH Zertifiziert

- Combinacion Textilene® y polyolefina, resistente a los rayos UV
- Resistente e hidrófuga al agua de piscina y de mar
- Fácil limpieza y mantenimiento, para un mantenimiento específico, limpiador woven & textiles (consulte p. 346)
- Todas las piezas se tejen a mano
- Reciclable, GreenGuard certificada, REACH certificada

- Combinazione Textilene® e polyolefina, resistente agli uv
- Resistente all'acqua di piscina e di mare, e idrorepellente
- Facile pulizia e manutenzione, per una manutenzione specific usare il woven & textiles cleaner (vedere p. 346)
- Ogni mobile è intrecciato a mano
- Riciclabile, GreenGuard certificata, REACH certificata

MATERIALS

WICKER

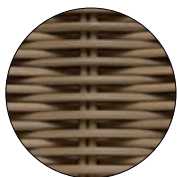

23
camel
2mm



23
camel
2.8mm

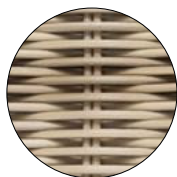

26
seashell
2mm

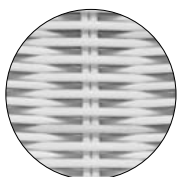

31
off white
2mm



44
hazel
2mm



84
old grey
6mm



84
old grey
8mm



90
black
2mm

THE FIBRES

- A synthetic fibre (HDPE), high quality thermoplastic fibre
- Resistant to great variations in temperature, even extreme, from -25°C (-13°F) to +70°C (158°F)
- Fibre dyed in the mass, UV-resistant, does not discolour in the light and sun
- Swimming pool and sea water resistant and repellent
- UV tested 3500 h of exposure DIN 53387 Xenon Arc radiation
- High stability with traction resistance >20 MPA (ISO527)
- Easy to clean and maintain, for specific maintenance, woven & textile cleaner (see p. 346)
- For outdoor and indoor use
- Different finishes available depending on collections
- Each item of furniture is assembled by hand
- Toxin-free, ecological, 100% recyclable

VEZELS

- Een synthetische thermoplastische vezel (HDPE) van uitstekende kwaliteit
- Bestand tegen grote temperatuurschommelingen, zelfs extreme van -25°C (-13°F) tot +70°C (158°F)
- In de massa gekleurde vezel, uv-bestendig, verkleurt niet onder de invloed van het licht en de zon
- Waterafstotend en bestand tegen water van zwembaden en zee water
- Beproeft uv-weerstand bij een blootstelling van 3500 uur DIN 53387 Xenon Arc radiation (straling xenon-lichtboog)
- Hoge stabiliteit met een trekweerstand > 20 MPa (ISO527)
- Gemakkelijke reiniging en onderhoud, voor een specifiek onderhoud, wovon & textile cleaner (zie p. 346)
- Voor gebruik buiten en binnen
- Verschillende afwerkingen verkrijgbaar naargelang de collectie
- Elk meubelstuk is met de hand gevlochten
- Zonder toxines, milieuvriendelijk, 100% recycleerbaar

FIBRE

- Une fibre synthétique (hdpe), fibre thermoplastique de haute qualité
- Résistante aux grandes variations de température même extrême de -25°C (-13°F) à +70°C (158°F)
- Fibre colorée dans la masse, résistante aux UV, ne se décolore pas sous l'action de la lumière et du soleil
- Résistante et hydrophobe à l'eau de piscine et de mer
- Testé uv 3500 h d'exposition DIN 53387 Xenon Arc radiation
- Haute stabilité avec une résistance à la traction > 20 MPA (ISO527)
- Nettoyage et entretien facile, pour un entretien spécifique, wovon & textile cleaner (voir p. 346)
- Pour une utilisation en extérieur et intérieur
- Différentes finitions disponibles selon les collections
- Chaque mobilier est tressé à la main
- Sans toxines, écologique, 100% recyclable

FASERN

- Hochqualitative thermoplastische Synthetikfaser (HDPE)
- Beständig selbst bei extremen Temperaturschwankungen von -25°C (-13°F) bis +70°C (158°F)
- Durchgefärbte Faser, UV-beständig
- Wasserabstoßend und Chlor- und Salzwasserbeständig
- UV-Test (3500 h Bewitterung DIN 53387 Bestrahlung mit Xenon-Bogenlampe)
- Hohe Stabilität mit Zugfestigkeit > 20 MPA (ISO 527)
- Einfache Reinigung und Pflege; für die spezielle Pflege wovon & textile cleaner (siehe S. 346)
- Für die Verwendung im Außen- und Innenbereich
- Unterschiedliches Oberflächenfinish je nach Kollektion
- Jedes Möbelstück ist von Hand geflochten
- Toxinfrei, ökologisch, 100% recyclingfähig

LAS FIBRAS

- Fibra sintética (HDPE), fibra termoplástica de alta calidad
- Resistente a grandes oscilaciones térmicas, incluso extremas de -25°C (-13°F) a +70°C (158°F)
- Fibra teñida en masa, resistente a los rayos UV, no se decolora por efecto de la luz y del sol
- Resistente e hidrófuga al agua de piscina y de mar
- Sometida a pruebas UV 3500 h de exposición DIN 53387 radiación con arco de xenon
- Alta estabilidad con resistencia a la tracción >20 MPA (ISO527)
- Fácil limpieza y mantenimiento, para un mantenimiento específico, limpiador textil (consulte p. 346)
- Utilizable al aire libre y en interiores
- Distintos acabados disponibles en función de las colecciones
- Todas las piezas se tejen a mano
- Sin toxinas, ecológica, 100% reciclable

VETRO

- Una fibra sintetica (hdpe), fibra termoplastica de alta qualità
- Resistente agli elevati sbalzi di temperatura, addirittura da -25°C (-13°F) fino a +70°C (158°F)
- Fibra colorata nell'impasto, resistente agli UV, non scolora se esposta alla luce o ai raggi solari
- Resistente all'acqua di piscina e di mare, e idrorepellente
- Testata con 3500 ore di esposizione agli UV con il test lampada ad arco allo xeno DIN 53387
- Alta stabilità con resistenza alla trazione > 20 MPA (ISO527)
- Facile pulizia e manutenzione, per una manutenzione specifica usare il wovon & textile cleaner (vedere p. 346)
- Per un utilizzo in ambienti esterni ed interni
- Diverse finiture disponibili in base alle collezioni
- Ogni mobile è intrecciato a mano
- Senza tossine, ecologico, riciclabile al 100%

MATERIALS

TEAK (T) / AGED TEAK (AT) / BRUSHED TEAK NERO (TN)



AT
aged teak



T
teak



TN
brushed teak
nero

- Superior quality teak wood (VINIR & HARA) aged 60 to 80 years, sourced from ecological plantations
- Great stability under the effect of UV radiation, chlorine and sea water
- Easy to clean, various specific treatments possible (see p. 346)
- For outdoor and indoor use
- 100% recyclable

- Teakhout van de beste kwaliteit (VINIR & HARA) van bomen van 60 tot 80 jaar, afkomstig van milieuvriendelijke aanplantingen
- Grote stabiliteit tegenover uv-stralen, chloor en zeewater
- Gemakkelijk te reinigen, diverse specifieke behandelingen mogelijk (zie p. 346)
- Voor gebruik buiten en binnen
- 100% recycleerbaar

- Bois teck de qualité supérieure (VINIR & HARA) âgé de 60 à 80 ans, provenant de plantations écologiques
- Grande stabilité sous l'effet des rayons UV, du chlore et de l'eau de mer
- Nettoyage facile, divers traitements spécifiques possibles (voir p. 346)
- Pour une utilisation en extérieur et intérieur
- 100% recyclable

- Hochqualitatives Teakholz (VINIR & HARA), Alter 60 – 80 Jahre, aus ökologischem Anbau
- Hohe UV-, Chlor- und Salzwasserbeständigkeit
- Einfache Reinigung, verschiedene spezielle Pflegemöglichkeiten (siehe S. 346)
- Für die Verwendung im Außen- und Innenbereich
- 100 % recyclingfähig

- Madera de teca de calidad superior (VINIR & HARA) envejecida de 60 a 80 años procedente de plantaciones ecológicas
- Extraordinaria estabilidad ante el efecto de los rayos UV, del cloro y del agua marina
- Fácil limpieza, se pueden utilizar diversos tratamientos específicos (consulte p. 346)
- Utilizable al aire libre y en interiores
- 100% reciclable

- Legno tek di qualità superiore (VINIR e HARA) invecchiato tra i 60 e gli 80 anni, proveniente da piantagioni ecologiche
- Grande stabilità se esposto ai raggi UV, al cloro e all'acqua di mare
- Facile pulizia, sono disponibili diversi trattamenti specifici (vedere p. 346)
- Per un utilizzo in ambienti esterni ed interni
- Riciclabile al 100%

IROKO (IR)



IR
iroko

- Superior quality West African hardwood – Durability classification 1
- Great stability under the effect of UV radiation, chlorine and seawater
- Easy to clean, standard pre-treated with wood protector water repellent (see p. 346)
- For outdoor and indoor use
- 100% recyclable

- Hoge kwaliteit West-Afrikaans hardhout – Duurzaamheidsklasse 1
- Grote stabiliteit tegenover UV-stralen, chloor en zeewater
- Gemakkelijk te reinigen, standaard voorbehandeld met een houtbeschermingsproduct – waterafstotend (zie p. 346)
- Voor buiten- en binnengebruik
- 100% recycleerbaar

- Bois dur de qualité supérieure, en provenance d'Afrique de l'Ouest Classement durabilité de niveau 1
- Grande stabilité sous l'effet des rayons UV, du chlore et de l'eau de mer.
- Facile à nettoyer, prétraité de série avec un produit protecteur hydrofuge (voir p. 346)
- Pour une utilisation en extérieur et intérieur
- 100% recyclable

- Westafrikanisches Hartholz mit überragender Qualität Dauerhaftigkeitsklasse 1
- Hohe UV-, Chlor- und Salzwasserbeständigkeit
- Einfach zu reinigen, als Standard mit Holzschutzmittel vorbehandelt - wasserabweisend (siehe S. 346)
- Für die Verwendung im Außen- und Innenbereich
- 100% recyclingfähig

- Madera dura de calidad superior procedente de África occidental. Clase de durabilidad 1
- Extraordinaria estabilidad ante el efecto de los rayos UV, del cloro y del agua marina
- Fácil limpieza, pretratada de serie con protector de madera y repelente al agua (ver p. 346).
- Utilizable al aire libre y en interiores
- 100% reciclable

- Legno duro dell'Africa Occidentale di qualità superiore Classificazione della durabilità 1
- Grande stabilità se esposto ai raggi UV, al cloro e all'acqua di mare
- Facile pulizia, pre-trattato standard con prodotto di protezione del legno idrorepellente (vedi p. 346)
- Per un utilizzo in ambienti esterni ed interni
- Riciclabile al 100%

MATERIALS

TRESPA® (HPL)

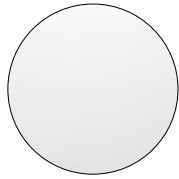

90 - TRW
white



92 - TRB
black



Trespa® is a flat thermo hardening resin-based sheet, homogenously reinforced with wood-based fibres and manufactured at high pressure and temperature (HPL – High Pressure Laminate). The visible side is covered in a decorative surface using the patented EBC technology.
For this Manutti works with 10 & 13 mm thick sheets.
For all colours the border has a black finish.

Trespa® is een vlakke plaat op basis van thermohardende harsen, homogeen versterkt met op hout gebaseerde vezels en vervaardigd onder hoge druk en temperatuur (HPL – High Pressure Laminate).
De zichtbare zijde wordt voorzien van een decoratief oppervlak met behulp van de gepatenteerde EBC-technologie. Manutti werkt hiervoor met platen met een dikte van 10 & 13 mm. De boord is bij alle kleuren afgewerkt in zwart.

Trespa® est un panneau plat à base de résines thermodurcissables, renforcé de manière homogène avec des fibres à base de bois et fabriqué sous haute pression et à haute température (HPL – High Pressure Laminate - Laminé à haute pression).
La face visible est dotée d'une surface décorative au moyen de la technologie EBC brevetée. Pour ce faire, Manutti travaille avec des panneaux d'une épaisseur de 10 & 13 mm. La finition du bord est pour tous les coloris en noir.

Trespa®-Platten werden auf der Basis wärmehärtender, gleichmäßig mit Holzfasern verstärkter Harze unter Hochdruck und bei hohen Temperaturen hergestellt (HPL – High Pressure Laminate).
Die sichtbare Seite wird nach dem patentierten EBC-Verfahren mit einer Deko-Oberfläche versehen. Manutti arbeitet mit 10 & 13 mm dicken Platten.
Bei allen Collectionsfarben ist die Tischkante grundsätzlich in der Farbe schwarz.

Trespa® es una placa plana compuesta básicamente de resinas termoendurecidas, reforzada de forma homogénea con fibras de madera y fabricada a alta presión y temperatura (HPL – laminado a alta presión).
La parte que queda a la vista incorpora una superficie decorativa por medio de la tecnología patentada EBC. Manutti trabaja con placas de 10 & 13 mm de grosor.
Para todos los colores el borde tiene una finición negra.

Trespa® è una lamina piatta a base di resine termoindurite rafforzata omogeneamente con fibre su base di legno e fabbricata ad alta pressione e temperatura. (HPL – High Pressure Laminate, laminato ad alta pressione). Il lato visibile viene fornito di una superficie decorativa grazie alla tecnologia brevettata EBC.
Manutti utilizza lamine con uno spessore di 10 & 13 mm. La rifinitura del bordo è per tutti i colori in nero.

MATERIALS

ACID ETCHED GLASS

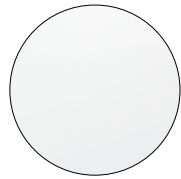

70 - GLW
white

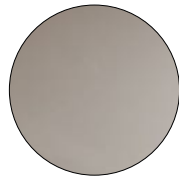

71 - GLT
taupe



72 - GLB
black

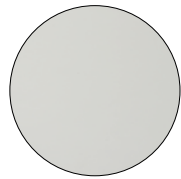

73 - GLS
sand

- Hardened glass, acid etched on the top, coloured on the bottom side. Specific gravity: 2.5 kg
- Colour fastness: differences in colour between different table tops can occur. These are caused by the different production batches in which they were made. A colour difference of delta E = 2, measured on the surface of the glass, is acceptable
- Tensile strength: intrinsic tensile strength 10,000 N/mm²
- Scratch resistance: no value available, but clearly sharp objects may cause scratches on the surface of the glass
- Thermal conductivity: 0.8 W/mK
- For outdoor and indoor use

- Gehard glas, aan bovenzijde verzuurd, kleur aan onderzijde ingebakken. Soortelijk gewicht: 2.5 kg
- Kleurechtheid: er kunnen kleurverschillen optreden tussen verschillende tafelbladen, te wijten aan verschillende productiebatches waarin ze gemaakt werden. Een kleurverschil van delta E = 2, gemeten aan het glasoppervlak, is aanvaardbaar
- Treksterkte: intrinsieke treksterkte 10.000 N/mm²
- Krasvastheid: geen waarde beschikbaar, maar het is evident dat scherpe voorwerpen krasen kunnen veroorzaken aan het glasoppervlak
- Warmtegeleidingscoëfficiënt: 0.8 W/mK
- Voor gebruik buiten en binnen

- Verre trempé, face supérieure acidifiée et couleur cuite en face inférieure. Poids spécifique : 2,5 kg
- Inaltérabilité des couleurs : des différences de couleur peuvent survenir entre différents plateaux de table, consécutives aux différents bains de production dans lesquels ces plateaux ont été fabriqués. Une différence de couleur de delta E = 2, mesurée au niveau de la surface du verre, est admissible
- Résistance à la traction : résistance à la traction intrinsèque de 10.000 N/mm²
- Résistance aux rayures : aucune valeur disponible, mais il est évident que les objets contondants peuvent entraîner des rayures à la surface du verre
- Coefficient de conductivité thermique : 0,8 W/mK
- Pour une utilisation en extérieur et intérieur

- Gehärtetes Glas, an der Oberseite gesäuert, Farbe an der Unterseite eingeschmolzen. Spezifisches Gewicht: 2.5 kg
- Farbechtheit: es können Farbunterschiede zwischen verschiedenen Tischblättern auftreten, zurückzuführen auf unterschiedliche Produktionsbatches in denen sie gemacht wurden. Ein Farbunterschied von Delta E = 2, gemessen an der Glasoberfläche, ist akzeptabel
- Ziehstärke: intrinsische Ziehstärke 10.000 N/mm²
- Kratzfestigkeit: kein Wert verfügbar, aber es ist selbstverständlich, dass scharfe Gegenstände Kratzer an der Glasoberfläche verursachen können
- Wärmeleitkoeffizient: 0.8 W/mK
- Für die Verwendung im Außen- und Innenbereich

- Vidrio templado, lado superior mateado al ácido, lado inferior de color esmaltado. Peso específico: 2.5 kg
- Estabilidad del color: el color de las hojas de vidrio puede variar ligeramente según la serie de producción. Una variación de color del valor delta E = 2, medida en la superficie del cristal, se considera aceptable.
- Resistencia a la tracción: resistencia a la tracción intrínseca 10.000 N/mm²
- Resistencia al rayado: no hay valores disponibles, pero es evidente que el contacto con objetos agudos o punzantes puede rayar la superficie del vidrio
- Coeficiente de conductividad térmica: 0.8 W/mK
- Utilizable al aire libre y en interiores

- Vetro temperato, lato superiore acidificato, di color cotto sul lato inferiore. Peso specifico: 2,5 kg
- Inalterabilità dei colori: è possibile notare differenze di colore tra i diversi piani del tavolo, a seguito di un diverso lotto di fabbricazione con il quale sono stati prodotti. Una differenza di colore dal delta E = 2, misurata a livello della superficie del vetro, risulta essere accettabile
- Resistenza alla trazione: resistenza alla trazione intrinseca pari a 10.000 N/mm²
- Resistenza alle graffiature: nessun valore disponibile, ma risulta evidente che gli oggetti contudenti possono provocare graffiature sulla superficie del vetro
- Coefficiente di conduzione termica: 0,8 W/mK
- Per un utilizzo in ambienti esterni ed interni

TEMPERED GLASS



GLASS

- Called tempered glass or safety glass
- Only obtainable in transparent or white toughened glass within the Manutti collection
- Hardened glass with a min. thickness of 6 to 8 mm depending on application
- Identical design to glass for car industry

GLAS

- Getemperd glas of veiligheidsglas genoemd
- Enkel te bekomen in transparant of wit gehard glas binnen de collectie Manutti
- Gehard glas met een min. dikte van 6 tot 8 mm afhankelijk van toepassing
- Identieke uitvoering zoals glas voor auto-industrie

VERRE

- Verre trempé, également appelé verre de sécurité
- Uniquement disponible en transparent ou en verre blanc durci au sein de la collection Manutti
- Verre durci d'une épaisseur minimale de 6 à 8 mm en fonction de l'application
- Exécution identique à celle du verre pour l'industrie automobile

GLAS

- Getempertes Glas oder auch Sicherheitsglas genannt
- In der Manutti-Kollektion ist Temperglas nur transparent oder in weiß erhältlich
- Temperglas mit einer Mindestdicke von 6 bis 8 mm je nach Verwendungszweck
- Gleiche Ausführung wie bei Sicherheitsglas für die Automobilindustrie

CRISTAL

- Cristal templado o, según se denomina, cristal de seguridad
- Sólo disponible en cristal rígido transparente o blanco en la colección Manutti
- Cristal rígido con un grosor mínimo de 6 a 8 mm, dependiendo de la aplicación
- Versión idéntica a la del cristal utilizado en la industria de la automoción

VETRO

- Vetro temperato, detto anche vetro di sicurezza
- Disponibile solamente in vetro trasparente o temperato nella collezione Manutti
- Vetro temperato con uno spessore minimo di 6-8 mm in base all'applicazione
- Stessa realizzazione del vetro per il settore automobilistico

MATERIALS

CERAMIC 6 mm

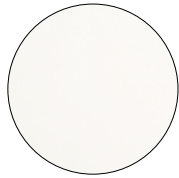

60 - CEW
white

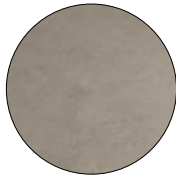

64 - CEQ
quartz



66 - CEL
perla



67 - CEK
basalt black

CERAMIC 12 mm



53 - CEF
fossil

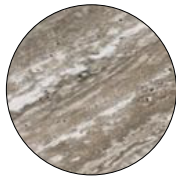

54 - CET
travertin geo



57 - CEK
basalt black



58 - CEMW
marble white



59 - CEMB
marble black

CERAMICS

The Manutti ceramic table tops are composed of sand, clay and natural stone formed into a layer which is baked at 1100°C. The 3 mm plates are cooled down and are glued together with a resin of polyurethane and fibre glass.

A few characteristics of ceramics are:

- Hygienic surface
- Colourproof
- Resistance to fire and high temperatures
- Impermeability
- Resistance to bending, scratching
- Resistance to wear and tear
- Resistance to chemical products
- Environment friendly
- For outdoor and indoor use

KERAMIEK

De keramische tafelbladen van Manutti zijn samengesteld uit zand, klei en natuursteen die omgevormd wordt tot een laag die gebakken wordt op 1100°C. De afgekoelde platen van 3 mm dik worden vervolgens per twee aan elkaar gelijmd met een harslijm van polyurethaan en glasvezel.

Eigenschappen van keramiek zijn:

- Hygiënisch oppervlak, ondoordringbaar
- Kleurbestendig
- Onderhoudsvriendelijk
- Vuur- en hittebestendig
- Bestand tegen chemische producten
- Zeer sterk en krasvrij
- Slijtvast
- Milieuvriendelijk
- Voor gebruik buiten en binnen

CERAMIQUE

Les plateaux en céramique de Manutti sont composés de sable, d'argile et de pierre naturelle pour être transformées en une couche cuite à 1100° C. De 3 mm, les plaques sont refroidies et collées par paires à l'aide d'une résine adhésive en polyuréthane et fibre de verre.

Les caractéristiques de céramique sont :

- Surface hygiénique, imperméable
- Couleurs inaltérables
- Entretien facile
- Résistance au feu et aux températures élevées
- Résistance aux produits chimiques
- Résistance à la flexion
- Résistance à l'usure
- Respect de l'environnement
- Pour une utilisation en extérieur et intérieur

KERAMIK

Die Manutti Keramik-Tischplatten bestehen aus Sand, Ton und Naturstein, die bis einer Masse transformiert werden und bei 1100° C gebacken werden. Die gekühlten Platten von 3mm dick werden nachher pro Paar zusammen geklebt mit einem Harz-Klebstoff aus Polyurethan. Zwischen beiden Platten fügen wir ein Glasfaser-Gewebe hinzu.

Die Eigenschaften von Keramik sind:

- Hygienische Oberflächen, undurchlässig
- Farbecht
- Einfache Wartung
- Feuer- und hitzebeständig
- Chemikalienbeständig
- Sehr stark und kratzfest
- Verschleissfest
- Umweltfreundlich
- Für die Verwendung im Außen- und Innenbereich

CERAMICO

Los tableros cerámicos de Manutti consisten de arena, arcilla y piedra natural que han sido cocidos a 1100°C, así formando una capa homogénea. Las capas enfriadas de 3mm luego son pegadas con una cola de poliuretano y fibra de vidrio. Las características de cerámico son las siguientes:

- Superficie higiénica
- Mantenimiento fácil
- Duradero
- No alteraciones de color
- Resistencia a la flexión al fuego y a las temperaturas elevadas
- Impermeabilidad
- Resistencia al desgas al rayado y a la abrasión
- Resistencia a productos químicos
- Respeto al medio ambiente
- Superficie higiénica Alteraciones de color
- Utilizable al aire libre y en interiores

CERAMICA

I piani del tavolo in ceramica di Manutti sono composti di sabbia, argilla e pietra naturale che è trasformato in un strata che viene cotto a 1100°C.

Le piastre di raffreddamento di 3 millimetri di spessore sono poi incollato da due insieme con una colla di resina di poliuretano e fibra di vetro. Proprietà delle ceramiche sono:

- Superficie igienica, impenetrabile
- Colore resistente
- Di facile manutenzione
- Fuoco e resistente al calore
- Resistente agli agenti chimici
- Molto forte e resistente ai graffi
- Resistente all'usura
- Ecologico
- Per un utilizzo in ambienti esterni ed interni

MATERIALS

STONE

STRAIGHT BORDER

bluestone 30 mm

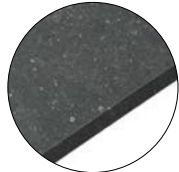

00 - BD
dark

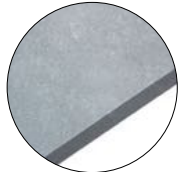

00 - BL
light

granite 30 mm



06 - GC
caramel

satingo 30 mm striped

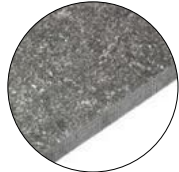

01 - SB
blue



01 - SS
sand

satingo 20 mm



09 - SN
nero

PARROT'S BILL

bluestone 30 mm

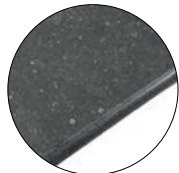

60 - BD
dark



60 - BL
light

satingo 30 mm

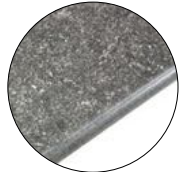

61 - SB
blue



61 - SS
sand

BELGIAN BLUESTONE

Belgian bluestone or "Little Granite" is a limestone with a more or less pronounced natural blue/grey colour, which is characterized by the presence of a large number of fossilised crinoids. This type of bluestone is only quarried in Belgium.

- It develops a natural patina
Use: outdoors, changes due to the action of rain and UV-rays to its original pale blue-grey colour
Use: indoors in the course of time, it develops a deeper colour
- Bluestone is susceptible to products and scratches
- Belgian bluestone can often contain a number of white veins (1), black lines, spots and fossils (2)
- Depending on the finishing, the stone has a different look

(1) "White veins" are water veins, formed by water, 100% specific to bluestone and are not cracks as people often assume.

(2) Fossils and colour differences: stone is a natural material formed by different perfectly petrified fossils. So it is normal to find nests of crustaceans in the stone.

In other words, even in one sheet of stone clear differences in colour can be observed.

BLUESTONE text is based on a publication by the WTCB (Wetenschappelijk en Technisch Centrum voor het Bouwbedrijf - Building Industry Scientific and Technical Centre)

BELGISCHE BLAUWSTEEN

Belgisch Blauwsteen of "Petit granit" (ook arduin genoemd) is een kalksteen met een min of meer uitgesproken natuurlijke blauwgrijze kleur, die wordt gekenmerkt door de aanwezigheid van erg veel crinoideresten (zeeliekersten).

Deze soort blauwsteen wordt uitsluitend ontgonnen in België.

- Deze steen ondergaat een natuurlijke patine
Gebruik: buitenshuis, evolueert door inwerking van regen en UV-stralen naar zijn oorspronkelijke bleekblauwe-grijze kleur
Gebruik: binnenshuis, bekomt na verloop van tijd een diepere kleur
- Arduin is product- en krasgevoelig
- Belgische blauwsteen kan steeds een aantal witte aders (1), zwarte lijnen, zwarte lijnen vlekken en fossielen (2) bevatten
- Afhankelijk van de afwerking, heeft de steen een andere 'look'

(1) "Witte aders" zijn wateraders, gevormd door insijpeling van water, 100% eigen aan blauwsteen en zijn geen barsten zoals soms wordt verondersteld.

(2) Fossielen en kleurverschillen: steen is een natuurlijk materiaal, gevormd door verschillende perfect versteende fossielen. Het is dus normaal dat men in de steen nesten van schelpachtigen aantreft. Maw zelfs in 1 plaat kan men duidelijke kleurverschillen aantreffen.

Text BLAUWSTEEN gebaseerd op een uitgave van het WTCB (Wetenschappelijk en Technisch Centrum voor het Bouwbedrijf)

LA PIERRE BLEUE BELGE

La pierre bleue belge ou "petit granit" est une pierre calcaire dotée d'un coloris naturel bleu gris plus ou moins prononcé. Elle est caractérisée par la présence de très nombreux fossiles crinoïdes (lis de mer). Ce type de pierre bleue est exclusivement extrait en Belgique.

- Subit une patine naturelle
Utilisation : à l'extérieur, en raison d'influence de la pluie et des rayons UV, évolue vers sa teinte gris bleu clair originelle
Utilisation : à l'intérieur, au fil du temps, revêt une couleur plus profonde
- La pierre bleue est sensible aux griffes et aux produits
- La pierre bleue belge peut toujours comporter un certain nombre de veines blanches (1), lignes noires, taches noires et fossiles (2)
- L'aspect de la pierre est déterminé par la finition

(1) Les "veines blanches" sont des veines aqueuses provoquées par l'infiltration d'eau. Elles sont 100% propres à la pierre bleue. Contrairement à la croyance populaire, il ne s'agit pas de fissures.

(2) Fossiles et différences de couleurs : la pierre est un matériau naturel constitué par différents fossiles parfaitement pétrifiés. Il est donc tout à fait normal que les pierres présentent des nids de fossiles de la famille des coquillages. En d'autres mots, on peut rencontrer des différences de couleurs marquées, même sur 1 seule plaque.

Texte PIERRE BLEUE basé sur une édition du CSTC (Centre Scientifique et Technique de la Construction)

BELGISCHER BLAUSTEIN

Belgischer Blaustein oder "Petit Granit" ist ein Kalkstein mit einer ausgesprochen natürlichen blaugrauen Farbe, die durch die Ansammlung von sehr vielen Crinoideresten (Seelilienresten) gekennzeichnet ist. Diese Art von Quaderstein wird ausschließlich in Belgien gewonnen.

- Belgischer Blaustein bekommt eine natürliche Patina
Verwendung outdoor: Durch Einwirkung von Regen und UV-Strahlen entwickelt er im Laufe der Zeit wieder seine ursprüngliche hellblau-graue Farbe.
Verwendung indoor: Er wird im Laufe der Zeit dunkler.
- Belgischer Blaustein ist kratzempfindlich und es können immer einige weiße Adern (1), schwarze Linien, schwarze Flecken und Fossilien (2) sichtbar sein.

(1) "Weiße Adern" sind Wasseradern, die durch Einsickern von Wasser gebildet werden; sie sind charakteristisch für Belgischen Blaustein und sind keine Risse, wie allgemein angenommen wird.
(2) Fossilien und Farbunterschiede: Stein ist ein natürliches Material und wird aus verschiedenen, perfekt versteinerten Fossilien gebildet. Es ist daher normal, dass im Stein Nesten von Muschelarten zu sehen sind. In einer Platte können daher Farbunterschiede auftreten.

Der Text BELGISCH GRANIT basiert auf einer Veröffentlichung des WTCB (Wissenschaftlich-Technisches Zentrum für das Baugewerbe)

GRANITO BELGA

El granito belga o "pequeño granito" es una piedra caliza con un tono gris azulado natural más o menos marcado que se caracteriza por la presencia de restos crinoideos (lirios marinos). Este tipo de granito se explota exclusivamente en Bélgica.

- Se somete a una patina natural
Utilización: en el exterior, por el efecto de la lluvia y los rayos UV va evolucionando hasta recuperar su color gris azulado pálido original
Utilización: en interiores adquiere un color más oscuro con el paso del tiempo
- El granito belga es sensible a los productos y arañazos
- El granito belga puede contener siempre una cierta cantidad de vetas blancas (1), líneas negras, manchas negras y fósiles (2)
- El "look" de la piedra es determinado por el acabado

(1) Las "vetas blancas" son vetas de agua, formadas por la filtración de agua, 100% naturales del granito belga y no son grietas, como se suele decir popularmente.

(2) Fósiles y diferencias en los colores: la piedra es un material natural formada con distintos fósiles perfectamente petrificados. Por tanto, es normal que se encuentren marcas de conchas en la piedra. En otras palabras, es posible observar diferencias en los tonos incluso en una misma placa.

Texto sobre el GRANITO BELGA basado en un informe del WTCB (Centro científico y técnico para la construcción, por sus siglas en neerlandés)

PIETRA BLU

La pietra blu belga o "granito piccolo" è una pietra calcarea di un colore naturale blue grigio con toni più o meno pronunciati. Al suo interno sono presenti fossili di crinoidi. Questo tipo di pietra blu è esclusivamente estratta in Belgio.

- Si sviluppa una patina naturale
Uso: all'esterno può cambiare tonalità se influenzata dalla pioggia e dai raggi UV
Uso: all'interno, col tempo, prende un colore più profondo
- La pietra blu è sensibile ai graffi e a sostanze chimico-naturali
- La pietra blu belga può sempre contenere un certo numero di venature bianche (1), linee/macchie nere e fossili (2)
- Il "look" della pietra è determinato dalla rifinitura.

(1) Sono delle venature idriche causate dall'infiltrazione dell'acqua. Sono 100% proprie alla pietra blu. Contrario alla convinzione popolare, non si tratta di fessure. (2) Fossili e differenze di colore: la pietra è un materiale naturale composto da diversi fossili perfettamente pietrificati, dunque è normale che le pietre presentino dei fossili della famiglia di conchiglie.

In altre parole, anche su una sola lamina possiamo osservare delle differenze di colore.

Fabrics

Colours, composition &
washing instructions





FABRICS BY COMPOSITION

100% acrylic

- 100% Acrylic fabric
- Developed specifically for outdoor use
- Fibres dyed in the mass, UV-resistant
- Swimming pool and sea water resistant and repellent
- Washable at 30°C (86°F)
- Light fastness: 7-8
- Resistance to pilling: 5
- Resistance to abrasion (Martindale): 12 000

- Weefsel 100% Acryl
- Specifiek ontwikkeld voor buitengebruik
- In de massa gekleurd, uv-bestendig
- Waterafstotend en bestand tegen water van zwembaden en zee water
- Wasbaar op 30°C (86°F)
- Lichtechtheid: 7-8
- Weerstand tegen pilling: 5
- Wrijftechtheid (Martindale): 12 000

- Tissu 100% Acrylique
- Développé spécifiquement pour un usage en extérieur
- Teinte dans la masse, résistant aux UV
- Résistant et hydrophobe à l'eau de piscine et de mer
- Lavable à 30°C (86°F)
- Solidité à la lumière: 7-8
- Résistance boulochage: 5
- Solidité au frottement (Martindale): 12 000

- Stoff 100% Acryl
- Speziell für die Verwendung im Außenbereich entwickelt
- Spinnfärbung, UV -beständig
- Wasserabstoßend und Chlor- und Salzwasserbeständig
- Waschbar bei 30°C (86°F)
- Lichtechtheit: 7-8
- Pillingeffekt: 5
- Scheuerfestigkeit (Martindale): 12 000

- Tejido 100% Acrílico
- Desarrollado específicamente para su uso en exteriores
- Teñido en masa, resistente a los rayos UV
- Resistente e hidrófugo al agua de piscina y de mar
- Lavable a 30°C (86°F)
- Resistencia a la luz: 7-8
- Resistencia a pilling: 5
- Resistencia a la fricción (Martindale): 12 000

- Tessuto Acrilico al 100%
- Sviluppato appositamente per l'impiego in ambienti esterni
- Colorato nell'impasto, resistente agli UV
- Resistente all'acqua di piscina e di mare, e idrorepellente
- Lavabile a 30°C (86°F)
- Resistenza alla luce: 7-8
- Resistenza al pilling: 5
- Resistenza d'attrito (Martindale): 12 000

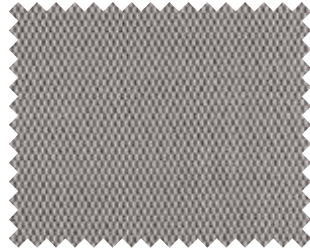

STORM
col. 06



ABYSS
col. 08



SOFT WHITE
col. 12



LIGHT PETROL BLUE
col. 14

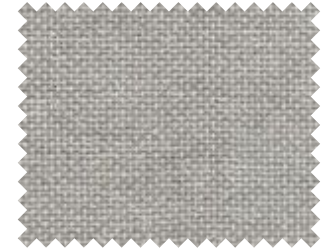

MILESTONE
col. 40



OLIVA
col. 45



DENIM
col. 46



CHERRY
col. 47



MINERAL
col. 48



GRAPHITE
col. 49



DUNE
col. 57



NAUTIC TAUPEGREY
col. 79N



METALLIC
col. 90

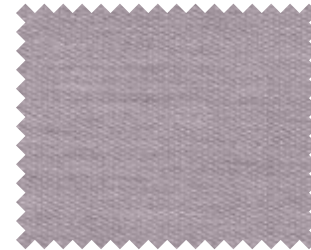

LILA
col. 91



COTTAGE GREEN
col. 92

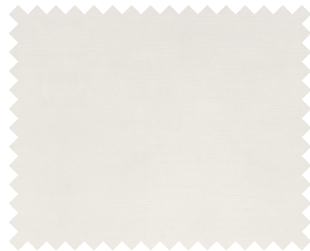

CANVAS
col. U109



BLACK
col. U110



TAUPE
col. U181



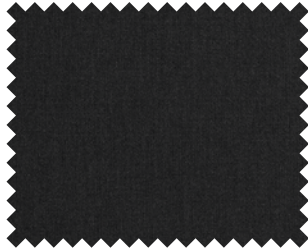

ROCK
col. 42



FOREST
col. 44



COSMOPOLITAN
col. 51



SUNSET
col. 56



SEAGREEN
col. 95

Polyester/PVC composite



- Polyester 85% / PVC 15% composition
- Developed specifically for outdoor and indoor use
- Dyed in the mass
- Swimming pool and sea water resistant and repellent
- Easy to clean and maintain, for specific maintenance, woven & textile cleaner (see p. 346)
- Light fastness: extreme light stability: > 3 UVA 340/2000 h
- Resistance to abrasion : very high use

- Stoff 85% Polyester / 15% PVC
- Speziell für die Verwendung im Außen- und Innenbereich entwickelt
- Durchgefärbt
- Wasserabstoßend und Chlor- und Salzwasserbeständig
- Einfache Reinigung und Pflege; für einen speziellen Pflege-, Textil- und Textilverreiniger (p.346)
- Lichtechtheit : extreme Stabilität < 3 UVA 340/2000 h
- Scheuerfestigkeit : extreme Nutzung möglich

- Weefsel 85% Polyester / 15% PVC
- Specifiek ontwikkeld voor buiten- en binnengebruik
- Gekleurd in de massa
- Waterafstotend en bestand tegen water van zwembaden en zeewater
- Gemakkelijke reiniging en onderhoud, voor een specifiek onderhoud, wovon & textile cleaner (zie p. 346)
- Lichtechtheid: extreme stabiliteit : < 3 UVA 340/2000 h
- Wrijftechtheid: zeer intens gebruik mogelijk

- Tejido 85% Poliéster / 15% PVC
- Desarrollado específicamente para su uso en exteriores e interiores
- Teñido en masa
- Resistente e hidrófugo al agua de piscina y de mar
- Fácil limpieza y mantenimiento, para un mantenimiento específico, limpiador textil (consulte p. 346)
- Comportamiento a la luz: < 3 UVA 340/2000 h
- Resistencia a la fricción : uso muy intenso

- Tissu 85% Polyester / 15% PVC
- Développé spécifiquement pour un usage en extérieur et intérieur
- Teinte dans la masse
- Résistant et hydrophobe à l'eau de piscine et de mer
- Nettoyage et entretien facile, pour un entretien spécifique, usare il woven & textile cleaner (voir p.346)
- Solidité à la lumière : extrême stabilité < 3 UVA 340/2000 h
- Solidité au frottement: utilisation extrême possible

- Tessuto 85% Poliestere / 15% PVC
- Sviluppato appositamente per l'impiego in ambienti esterni ed interni
- Colorato nell'impasto
- Resistente all'acqua di piscina e di mare, e idrorepellente
- Facile pulizia e manutenzione, per una manutenzione specifica usare il woven & textile cleaner (vedi p. 346)
- Resistenza alla luce: < 3 UVA 340/2000 h
- Resistenza d'attrito : uso molto intenso



TEXTILES BRONZE
col. T3



TEXTILES BLACK
col. T7



TEXTILES WHITE
col. T8



TEXTILES MOCCA
col. T10

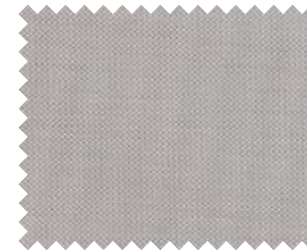

TEXTILES SAND
col. T11



TEXTILES ECRU
col. T12

FABRICS BY COMPOSITION

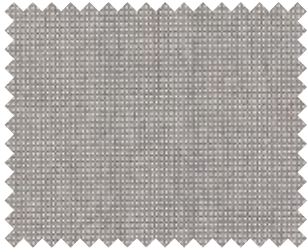

SAPPHIRE
col. 23



SMOKEY
col. 27



SPARROW
col. 28



NAUTIC COAL BLACK
col. N30



NAUTIC WHITE GREY
col. N31



NAUTIC GREY-QUARTZ
col. N32

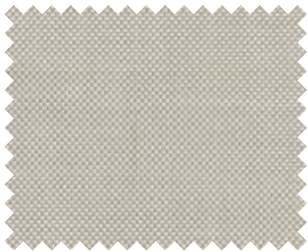

WHITE SAND
col. 38



YELLOW
col. 43



CLOUD
col. 53



VANILLA
col. 58



LINEN
col. 59



LAGOON DIAMONDS
col. 69

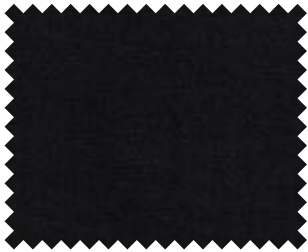

CHARCOAL
col. 74

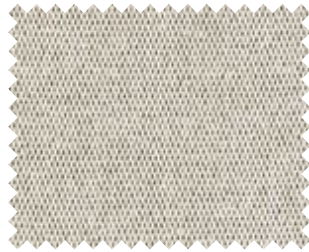

HAVANNA
col. 75



KHAKI
col. 78



PURPLE
col. 81



AUBERGINE
col. 82



PUMPKIN
col. 85



OREGANO
col. 94



AZZURE
col. 96

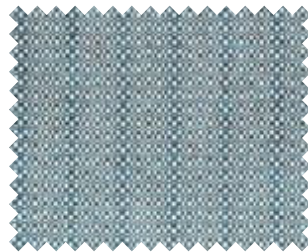

PAVONE BLUE
col. 97



ICE BLUE
col. 36

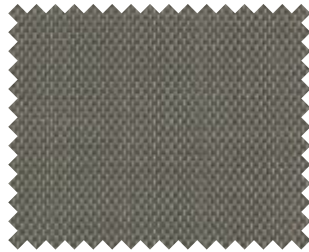

HAZELNUT
col. 37



SHELL WHITE
col. 70

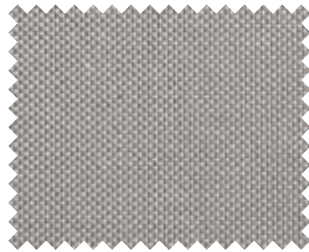

FLANNEL
col. 73



MUSTARD
col. 89



JADE
col. 93

100% Polyolefin

- 100% Polyolefin fabric
- Developed specifically for outdoor use
- Fibres dyed in the mass, UV-resistant
- Swimming pool and sea water resistant and repellent
- Washable at 30°C (86°F)
- Light fastness: 7
- Resistance to pilling: 5
- Resistance to abrasion (Martindale): 15 000
- 100% recyclable

- Weefsel 100% Polyolefin
- Specifiek ontwikkeld voor buitengebruik
- In de massa gekleurd, uv-bestendig
- Waterafstotend en bestand tegen water van zwembaden en zeewater
- Wasbaar op 30°C (86°F)
- Lichtechtheid: 7
- Weerstand tegen pilling: 5
- Wrijftechtheid : Martindale: 15 000
- 100% recycleerbaar

- Tissu 100% Polyolefine
- Développé spécifiquement pour un usage en extérieur
- Teinte dans la masse, résistant aux UV
- Résistant et hydrophobe à l'eau de piscine et de mer
- Lavable à 30°C (86°F)
- Solidité à la lumière: 7
- Resistance boulochage: 5
- Solidité au frottement (Martindale): 15 000
- 100% recyclable

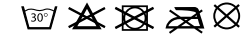

- Stoff 100 % Polyolefin
- Speziell für die Verwendung im Außenbereich entwickelt
- Spinnfärbefärbt, UV -beständig
- Wasserabstoßend und Chlor- und Salzwasserbeständig
- Waschbar bei 30°C (86°F)
- Lichtechtheit: 7
- Pillingeffekt: 5
- Scheuerfestigkeit (Martindale): 15 000
- 100% recyclingfähig

- Tejido 100% Polyolefin
- Desarrollado específicamente para su uso en exteriores
- Teñido en masa, resistente a los rayos UV
- Resistente e hidrófugo al agua de piscina y de mar
- Lavable a 30°C (86°F)
- Resistencia a la luz: 7
- Resistencia a pilling: 5
- Resistencia a la fricción (Martindale): 15 000
- 100% reciclable

- Tessuto Polyolefin al 100%
- Sviluppato appositamente per l'impiego in ambienti esterni
- Colorato nell'impasto, resistente agli UV
- Resistente all'acqua di piscina e di mare, e idrorepellente
- Lavabile a 30°C (86°F)
- Resistenza alla luce: 7
- Resistenza al pilling: 5
- Resistenza d'attrito (Martindale): 15 000
- 100% riciclabile

FABRICS BY COMPOSITION

Composition Polyolefin / Polyester

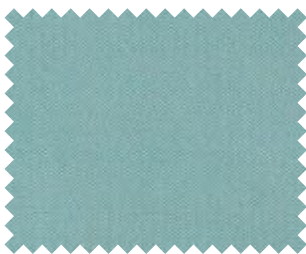
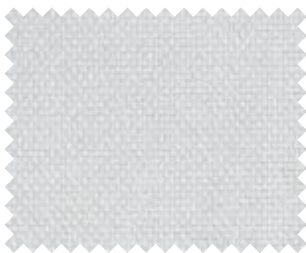
LAGOON
col. 67MIDNIGHT
col. 24CIMENTO
col. 03SEPIA
col. 04LAGOON STRIPES
col. 68

- Fabrics: 55% PP/45 Pes – 60% PP/40% Pes – 80% PP/12% Pes
- Developed specifically for outdoor use
- Fibres dyed in the mass, UV-resistant
- Swimming pool and sea water resistant and repellent
- Washable at 30°C (86°F)
- Light fastness: ≥6
- Resistance to pilling: 5
- Resistance to abrasion (Martindale): 30 000
- Recyclable

- Weefsels : 55% PP/45 Pes – 60% PP/40% Pes – 80% PP/12% Pes
- Specifiek ontwikkeld voor buitengebruik
- In de massa gekleurd, uv-bestendig
- Waterafstotend en bestand tegen water van zwembaden en zeewater
- Wasbaar op 30°C (86°F)
- Lichtechtheid: ≥6
- Weerstand tegen pilling: 5
- Wrijftechtheid (Martindale): 30 000
- Recycleerbaar

- Tissus : 55% PP/45 Pes – 60% PP/40% Pes – 80% PP/12% Pes
- Développé spécifiquement pour un usage en extérieur
- Teinte dans la masse, résistant aux UV
- Résistant et hydrophobe à l'eau de piscine et de mer
- Lavable à 30°C (86°F)
- Solidité à la lumière: ≥6
- Résistance boulochage: 5
- Solidité au frottement (Martindale): 30 000
- recyclable

- Stoff : 55% PP/45 Pes – 60% PP/40% Pes – 80% PP/12% Pes
- Speziell für die Verwendung im Außenbereich entwickelt
- Spinnfärbung, UV -beständig
- Wasserabstoßend und Chlor- und Salzwasserbeständig
- Waschbar bei 30°C (86°F)
- Lichtechtheit: ≥6
- Pillingeffekt: 5
- Scheuerfestigkeit (Martindale): 30 000
- recyclingfähig

- Tejidos : 55% PP/45 Pes – 60% PP/40% Pes – 80% PP/12% Pes
- Desarrollado específicamente para su uso en exteriores
- Teñido en masa, resistente a los rayos UV
- Resistente e hidrófugo al agua de piscina y de mar
- Lavable a 30°C (86°F)
- Resistencia a la luz: ≥6
- Resistencia a pilling: 5
- Resistencia a la fricción (Martindale): 30 000
- Recyclable

- Tessuti : 55% PP/45 Pes – 60% PP/40% Pes – 80% PP/12% Pes
- Sviluppato appositamente per l'impiego in ambienti esterni
- Colorato nell'impasto, resistente agli UV
- Resistente all'acqua di piscina e di mare, e idrorepellente
- Lavabile a 30°C (86°F)
- Resistenza alla luce: ≥6
- Resistenza al pilling: 5
- Resistenza d'attrito (Martindale): 30 000
- Riciclabile

88% PVC + 12% Polyester (Artificial leather)



NAUTIC LEATHER WHITE
col. 33N

- Artificial leather (leather appearance) with PES fabric + PVC coating
- Developed specifically for outdoor use
- Dyed in the mass, UV-resistant
- Swimming pool and sea water resistant and repellent
- Easy to clean and maintain, use water with a mild soap
- Light fastness: 7-8
- Resistance to abrasion (Martindale): >100 000
- Flame retardant : BS 5852 Source 0 - 1

- Kunstleder (Lederoptik) PVC-beschichtete Polyestergewebe
- Speziell für die Verwendung im Außenbereich entwickelt
- Durchgefärbt, UV -beständig
- Wasserabstoßend und Chlor- und Salzwasserbeständig
- Einfache Reinigung und Pflege: Verwenden Sie Wasser mit einer milden Seife
- Lichtechtheit: 7-8
- Scheuerfestigkeit (Martindale): > 100 000
- Schwer entflammbar: BS 5852 Source 0-1

- Kunstleer (uitzicht van leder) op basis van PVC met Polyester drager
- Specifiek ontwikkeld voor buitengebruik
- In de massa gekleurd, UV-bestendig
- Waterafstotend en bestand tegen water van zwembaden en zeewater
- Gemakkelijke reiniging en onderhoud, gebruik water met zachte zeep
- Lichtechtheid: 7-8
- Wrijfvechtheid (Martindale): > 100 000
- Vlamvertragend : BS 5852 Source 0 - 1

- Imitación de cuero (aspecto de piel) con tejido PES + coating PVC
- Desarrollado específicamente para su uso en exteriores
- Teñido en masa, resistente a los rayos UV
- Resistente e hidrófugo al agua de piscina y de mar
- Fácil limpieza y mantenimiento: usa agua con un jabón suave
- Resistencia a la luz: 7-8
- Resistencia a la fricción (Martindale): 100 000
- Retardante de llama: BS 5852 source 0 - 1

- Simili cuir (aspect cuir) tissu PES + coating PVC
- Développé spécifiquement pour un usage en extérieur
- Teinte dans la masse, résistant aux UV
- Résistant et hydrophobe à l'eau de piscine et de mer
- Nettoyage et entretien facile : utiliser de l'eau avec un savon doux
- Solidité à la lumière: 7-8
- Solidité au frottement (Martindale): >100 000
- Flame retardant : BS 5852 Source 0 - 1

- Similpelle (aspetto pelle) tessuto in PES + coating in PVC
- Sviluppato appositamente per l'impiego in ambienti esterni
- Colorato nell'impasto, resistente agli UV
- Resistente all'acqua di piscina e di mare, e idrorepellente
- Facile pulizia e manutenzione : usare acqua con un sapone delicato
- Resistenza alla luce: 7-8
- Resistenza d'attrito (Martindale): 100 000
- Igñifugo : BS 5852 source 0 - 1

Protection & maintenance

Carefree enjoyment
for years to come

Each Manutti product has been developed with an eye for the smallest details. The greatest attention is paid to the selection of the best raw materials and finishings, since outdoor furniture must withstand very diverse weather conditions. To maintain and protect your Manutti furniture, we have especially developed a series of maintenance products that will make your life easier and the life of your furniture longer. Allowing you carefree enjoyment of your exclusive Manutti outdoor furniture for years to come.





Protective covers

Manutti does not recommend using protective covers for wood tops (aged teak, teak and iroko) to prevent mold growth.



We offer an appropriate cover solution for almost every collection.

Whether you are looking for an easy way to protect your Manutti furniture from bad weather conditions or for an elegant solution to store your Manutti pieces in the off-season: our protective covers will do the trick.

Our soft covers present you with the best stain and water-repellent outdoor protection. With handy stay-on straps, our close fit covers ensure easy placement and maintenance. In addition, their antifungal properties will prevent the build up of mold and other fungi.



POLYURETHANE COATED SOFT COVERS

- Welded, not stitched seams (no water infiltration possible)
- Mold and fungal resistant
- Breathable fabric
- Die Nähte der Schutzhüllen sind nicht genäht, sondern verschweisst (Eindringen von Wasser also unmöglich)
- Bakterien und Schimmel resistent
- Atmungsaktiver Stoff
- Gelaste ipv gestikte naden (dus geen waterdoorsijpeling mogelijk)
- Bactérie- en schimmelwerend
- Ademende stof
- Costuras soldadas, no cosidas (no hay infiltración de agua posible)
- Resistente al moho y hongos
- Tejido transpirable
- Soudure au lieu de couture (infiltration d'eau impossible)
- Anti Bactérie et moisissure
- Tissu imper-respirant
- Le cuciture sono saldati e non cucite, in tal modo infiltrazione d'acqua può essere evitato.
- Sottoposto a trattamento protettivo contro muffe e funghi.
- Tessuto traspirante

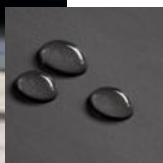

Furniture cover

A protective cover is made to fit each separate piece of furniture: it follows the lines of the design so that, even when covered, you still can see the beautiful shape of your Manutti furniture. The protective covers for stackable chairs and 1-seaters fit over 4 stacked pieces.



KUMO p. 260



ELEMENTS p. 262



MOON ISLAND p. 268



KOBO p. 270



CASCADE p. 271



DUO p. 272



RADIUS p. 273



ECHO p. 274



LOOP p. 275



ZENDO p. 276



LINER p. 279



SQUAT p. 280



RIVER p. 283



SAN DIEGO p. 292

Concept cover

A concept cover is made to order to cover up your chosen Manutti concept in full. An easy-fitting solution.



KUMO p. 260



ELEMENTS p. 262



ZENDO p. 276



SQUAT p. 280



FUSE p. 290



SAN DIEGO p. 292

Tabletop covers

Our custom size tabletop covers only cover up the tabletop, not the support of the table nor the chairs you choose to use with the table.

Only for Trespa®, acid etched glass and ceramic table tops



For more information about availability and dimensions, please refer to the pricelist.

Maintenance product range



MAINTENANCE PRODUCTS

ALUMINIUM & METAL FURNITURE

ALUMINIUM EN METALEN MEUBELN - MEUBLES EN ALUMINIUM ET EN METAL

MÖBELN AUS ALUMINIUM UND METALL - MUEBLES DE ALUMINIO Y DE METAL - MOBILI IN ALLUMINIO E METALLO



ALU & METAL PROTECTOR

- Cleaning wax that protects the lacquered aluminium or metal on your Manutti garden furniture.
- Reinigende wax die het gelakte aluminium of metaal van uw Manutti tuinmeubelen beschermt.
- Cire nettoyante qui protège l'aluminium ou le métal laqué de vos meubles de jardin Manutti.
- Reinigendes Wachs, das lackiertes Aluminium oder Metall Ihrer Manutti Outdoormöbeln schützt.
- Cera limpiadora que protege el aluminio o metal lacado de sus muebles de jardín Manutti.
- Cera pulente che protegge l'alluminio o il metallo laccati dei vostri mobili da giardino Manutti.

ref. 10006
€ 0,5L



CORRECTION PEN FOR POWDER COATED SURFACES

- Quick drying liquid paint (liquid, solvent free) for polyester powder coated surfaces.
- Ideal for retouching and repairing surface marks (impact, scratches, abrasion) on the powdercoating.
- Vloeibare sneldrogende verf (watergedragen, vrij van solventen) voor polyesterverlakte oppervlakken.
- Is ideaal voor retouches en herstellingen van oppervlaktebeschadigingen (schokken, krassen, wrijving).
- Peinture liquide hydro (sans solvants) pour surfaces laquées en poudre.
- Idéale pour des retouches et réparations des blessures superficielles (chocs, griffes, frottements).
- Flüssigfarbe (frei von Lösungsmitteln) schnelltrocknend für lackierte Flächen mit Polyesterpulverlacken.
- Ideal für Ausbesserungen und Reparaturen oberflächlicher Schäden (Stöße, Kratzer, Abrieb).
- Pintura líquida (sin solventes) de secado rápido para superficies lacadas en polvo.
- Ideal para retoques y reparaciones de daños superficiales (golpes, rasas, rozaduras).
- Vernice líquida ad asciugatura rapida (acquosa, priva di solventi) per superfici laccate a polvere.
- È ideale per ritocchi e riparazioni di lesioni superficiali (urti, graffi, attriti)

ref. COR PCA
€ 10ml

STAINLESS STEEL FURNITURE

ROESTVRIJ STALEN MEUBELN - MEUBLES EN ACIER INOXYDABLE - MÖBELN AUS ALUMINIUM UND EDELSTAHL

MUEBLES DE ACERO INOXIDABLE - MOBILI IN ACCIAIO INOSSIDABILE



STAINLESS STEEL CLEANER & RESTORER

- Cleans stainless steel and restores its original beauty. Makes the surface resistant to dirt and moisture.
- Reinigt roestvrij staal en geeft het zijn oorspronkelijke schoonheid terug.
- Maakt het oppervlak vuil- en vochtafstotend.
- Nettoie l'inox et lui rend sa beauté originelle. Protège la surface contre les saletés et l'humidité.
- Reinigt Edelstahl und gibt ihm seine ursprüngliche Schönheit zurück.
- Macht die Oberfläche schmutz- und feuchtigkeitsabstoßend.
- Limpia el acero inoxidable, devolviéndole su belleza original.
- Repele la suciedad y la humedad de las superficies
- Pulisce l'acciaio inossidabile e gli restituisce la sua bellezza originaria.
- Rende la superficie idrorepellente e resistente allo sporco.

ref. 10004
€ 0,5L



STAINLESS STEEL WAX PROTECTOR

- Removes superficial oxidation deposits on stainless steel, and prevents oxidation spots on your furniture.
- Verwijdert oppervlakkige oxidatieaanslag op roestvrij staal en voorkomt dat uw meubelen oxidatievlekjes vertonen.
- Enlève le voile d'oxydation sur vos meubles en inox et renforce leurs propriétés anticorrosion.
- Entfernt oberflächliche Oxidation auf Edelstahl und vermeidet, dass die Oberfläche Oxidationsflecken aufweist.
- Elimina la película de oxidación superficial del acero inoxidable, y evita que sus muebles presenten pequeñas manchas de oxidación.
- Elimina l'ossidazione superficiale sull'acciaio inossidabile ed evita che i vostri mobili mostrino macchioline di ossidazione.

ref. 10005
€ 0,5L

MAINTENANCE PRODUCTS

TEAK FURNITURE

TEAK MEUBELN - MEUBLES EN TECK - TEAKMÖBELN - MUEBLES DE TECA - MOBILI IN TEAK



ref. 10001
€ 1L

TEAK CLEANER

- Cleans greyed teak furniture and restores its clean and sturdy appearance.
- Reinigt grijs geworden teakhouten meubelen en geeft ze opnieuw een fris en stevig uiterlijk.
- Nettoie les meubles en teck devenus grisâtres, ravive leur éclat et leur apparence robuste.
- Reinigt grau gewordene Teakholzmöbeln und verleiht ihnen aufs Neue ein stabiles Aussehen.
- Limpia los muebles de madera de teca descoloridos, devolviéndoles su aspecto fresco y sano.
- Pulisce i mobili in legno di teak ingrigiti e conferisce loro nuovamente un aspetto fresco e robusto.



ref. 10003
€ 1L

TEAK COLOUR REFRESHER

- Maintains the natural, golden brown colour of teak longer and restores greyed teak to its natural colour.
- Houdt de natuurlijke, goudbruine kleur van teakhout langer in stand en geeft vergrijste teak opnieuw zijn natuurlijke kleur.
- Aide le teck à garder plus longtemps sa couleur dorée naturelle et ravive l'éclat du teck terni.
- Bewahrt die natürliche, goldbraune Farbe von Teakholz und verleiht grau gewordenem Teakholz abermals seine natürliche Farbe.
- Conserva durante más tiempo el color marrón dorado natural de la madera de teca, y devuelve a la madera de teca descolorida su color natural.
- Mantiene più a lungo il naturale colore bruno dorato del legno di teak e ridona al legno di teak ingrigito il suo colore naturale.



ref. 10002
€ 1L

TEAK STAIN PROTECTOR

- Saturates teak to make it impenetrable for liquids and dirt.
- Verzadigt teakhout zodat het ondoordringbaar wordt voor vloeistoffen en vuil.
- Imprègne le teck afin de le rendre imperméable aux liquides et saletés.
- Zieht tief in Teakholz ein, so dass es gegen Flüssigkeiten und Schmutz beständig ist.
- Satura la madera de teca, haciéndola impermeable a los líquidos e impenetrable a la suciedad.
- Nutre il legno di teak rendendolo impermeabile a liquidi e sporco.

WICKER & BATYLINE® FURNITURE

WICKER EN BATYLINE MEUBELN - MEUBLES EN RESINE ET BATYLINE - RESIN-UND BATYLINE-MÖBELN - MUEBLES DE RESINA Y BATYLINE - MOBILI IN RESINA E BATYLINE



ref. 10000
€ 0,5L

WOVEN & TEXTILES CLEANER

- Cleans braided PVC and batyline used in the woven seats and supports of Manutti garden furniture. Not suitable for textile.
- Reinigt gevlochten kunststof en batyline dat gebruikt wordt in vlechtwerkzittingen en -leuningen van Manutti tuinmeubelen. Niet geschikt voor textiel.
- Nettoie les garnitures tressées en matière plastique et la batyline utilisée pour les assises et dossiers tressés des meubles de jardin Manutti. Ne convient pas pour le textile.
- Reinigt geflochtenen Kunststoff und Batyline, das in geflochtenen Sitzflächen und Lehnen von Manutti Outdoormöbeln verwendet wurde. Nicht geeignet für Textilien.
- Limpia el material sintético y el batyline utilizados para los asientos y respaldos trenzados de los muebles de jardín Manutti. No apto para textiles.
- Pulisce i materiali sintetici ed il batyline intrecciati utilizzati nei sedili e negli schienali intrecciati dei mobili da giardino Manutti. Non è adatto per i tessuti.

NATURAL STONE

NATUURSTEEN - PIERRES NATURELLES - NATURSTEIN - PIEDRA NATURAL - PIETRA NATURALE



STONE CLEANER

- Removes spots on natural stone, from wine to marker pens, and from oil to mould.
- Verwijdert vlekken op natuursteen, van wijn tot alcoholstift en van olie tot schimmel.
- Enlève les taches de la pierre naturelle, du vin aux moississures en passant par l'huile et les feutres à l'alcool.
- Entfernt Flecken auf Naturstein – von Wein bis Permanent-Marker und von Öl bis Schimmel.
- Elimina las manchas de la piedra natural, desde manchas de vino y rotuladores indelebles hasta manchas de aceite y moho.
- Elimina le macchie sulla pietra naturale, dal vino al pennarello all'alcol, e dall'olio alla muffa.

ref. 10007
€ 0,5L

STONE STAIN PROTECTOR

- Penetrates natural stone to protect the surface against grease, moisture and dirt. Does not glaze, and allows the stone to continue to breathe. Limited or no discolouration.
- Dringt in natuursteen om het oppervlak te beschermen tegen vet, vocht en vuil. Glans niet en laat de steen verder ademen. Verkleurt niet of nauwelijks.
- Pénètre la pierre naturelle afin de protéger sa surface contre la graisse, l'humidité et les saletés. Ne brille pas et laisse la pierre respirer. Ne décolore pas ou très peu.
- Zieht in Naturstein ein und schützt die Oberfläche gegen Fett, Feuchtigkeit und Schmutz. Glänzt nicht und lässt den Stein weiter atmen. Verfärbt sich nicht oder kaum.
- Penetra en la piedra natural para proteger su superficie contra la grasa, la humedad y la suciedad. No brilla y permite que la piedra siga respirando. No altera (apenas) el color de la piedra.
- Penetra nella pietra naturale per proteggere la superficie da grasso, umidità e sporco. Non è lucido, e fa tornare a respirare la pietra. Non stinge, o stinge appena.

ref. 10008
€ 0,5L

STONE COLOUR REFRESHER

- Restores and deepens the colour of weather-beaten, dark natural stone such as bluestone, granite and satingo nero.
- Herstelt en verdiept de kleur van verweerde, donkere natuursteen zoals arduin, graniet en nero satingo.
- Approfondit et ravive la couleur de la pierre naturelle sombre et usée, comme la pierre de taille, le granit et la satingo nero.
- Die Farbe von verwittertem, dunklem Naturstein wie Schiefer, Granit oder Satingo Nero erstrahlt wieder in ursprünglicher Schönheit und wird vertieft.
- Restaura e intensifica el color alterado y oscurecido por los agentes atmosféricos de la piedra natural como el granito, el granito belga, el mármol y el Satingo Nero.
- Recupera ed intensifica il colore della pietra naturale scura corrosa, come pietra da taglio, granito e nero satingo.

ref. 10009
€ 0,5L

GREASE & OIL REMOVER FOR STONE

- Removes soaked in spots from natural stone and absorbs impurities from the stone. Subsequent treatment with Manutti Stone Stain Protector is recommended.
- Verwijdert geabsorbeerde vlekken uit natuursteen en slorpt onzuiverheden uit de steen op. Een nabehandeling met Manutti Stone Stain Protector is aangeraden.
- Enlève les taches profondes de la pierre naturelle et absorbe les impuretés. Un post-traitement au Manutti Stone Stain Protector est recommandé.
- Entfernt absorbierte Flecken aus Naturstein und nimmt Verschmutzungen aus dem Stein auf. Eine Nachbehandlung mit Manutti Stone Stain Protector wird empfohlen.
- Restaura e intensifica el color alterado y oscurecido por los agentes atmosféricos de la piedra natural como el granito, el granito belga, el mármol y el Satingo Nero.
- Rimuove dalla pietra naturale le macchie assorbite e risucchia impurità dalla pietra. Si consiglia un successivo trattamento con Manutti Stone Stain Protector.

ref. 10010
€ 0,25L

GLASS AND TRESPA®

NATUURSTEEN - PIERRES NATURELLES - NATURSTEIN - PIEDRA NATURAL - PIETRA NATURALE



GLASS, TRESPA® AND SILESTONE® CLEANER & POLISHER

- Is ideal for removing all kinds of stains (like light scale and marks due to water residu). Together with the included cloth and thanks to the light sand structure of the cleaner the table top is easy to clean without leaving scratches.
- Is ideaal om allerlei vlekken (zoals lichte kalkaanslag of randafzetting door water) te verwijderen. Dankzij het bijgeleverde doekje en de lichte zandstructuur van de cleaner kan het tafelblad makkelijk gereinigd worden zonder krassen te veroorzaken.
- Est idéal pour enlever toutes sortes de tâches (même de calc). À l'aide du chiffon compris et grâce à la structure sableuse les tâches peuvent être enlevées sans rayer le plateau.
- Ist ideal, um jegliche Art von Flecken zu entfernen (wie z.B. Kalkflecken und Wasserränder). Zusammen mit dem beiliegenden Tuch und dank seiner leicht körnigen Konsistenz, ist die Tischplatte mit diesem Pflegemittel problemlos zu reinigen, ohne dass Kratzer zurückbleiben.
- Es ideal para limpiar todos tipos de manchas (por ejemplo costra de cal, pequeñas manchas de agua secada). Gracias al paño incluido y a la estructura arenosa se puede limpiar el tablero sin rayarlo.
- E ideale per togliere qualsiasi macchia (come il deposito calcare dell' acqua). Grazie alla spugnetta in dotazione e alle struttura leggermente sabbiosa del cleaner si pu`o facilmente pulire senza lasciare graffi.

ref. 10011
€ 0,25L

Each product includes clear directions for use
 Bij elk product vindt u een duidelijke gebruiksaanwijzing
 Chaque produit s'accompagne d'un mode d'emploi clair
 Zu jedem Produkt gehört eine gut verständliche Gebrauchsanweisung
 Todos nuestros productos van acompañados de un modo de empleo claro
 Allegate ad ogni prodotto trovate chiare istruzioni per l'uso

Join the Manutti community

Our online presence allows us to connect with our customers in a more personal way. We find it inspiring to talk to fellow design enthusiasts and love giving our followers behind-the-scenes updates about our brand. It's this dialogue that gives us a treasure chest of information to further improve our products and services.

What's in it for you? Unlimited access to the latest inspirational Manutti updates and a chance to become part of our creative process.





COPYRIGHT

All Manutti designs, names, photos and intellectual property used in this brochure are the copyright of Manutti. Any infringement or abuse of our copyright will be pursued by law. Manutti always reserves the right to make changes or additions to the descriptions or features given in this brochure in the light of technical developments or availability of materials. We are not responsible for variations in colour, weight or dimensions, as variations are possible whenever products are hand-made.

All Manutti designs are registered trademarks and copyrighted by Manutti. Our trademark is protected by law and all infringements against our trademark and our copyright will be pursued by law.

Photo page 20 © Maurizio Paradisi CRN Shipyard - CRN 132 M/Y "Yalla" 73mt

MANUTTI Head office - Beverenstraat 13 -17 | 8540 Deerlijk - Belgium
Tel. + 32 56 645 625 | info@manutti.com

MANUTTI'S COMBOS

Colour is the spice to our furniture. To create an outdoor space that reflects your customers lifestyle and personality we created a wide range of colour combinations to choose from. Carefully selected and well balanced.

CAT. A

COMBO A1



COMBO A2

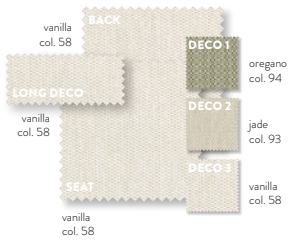

COMBO A3

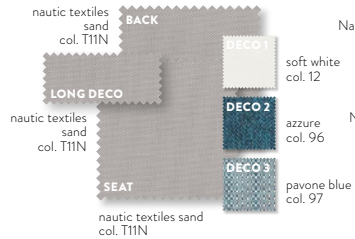

COMBO A4

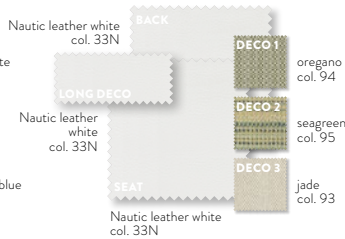

COMBO A5

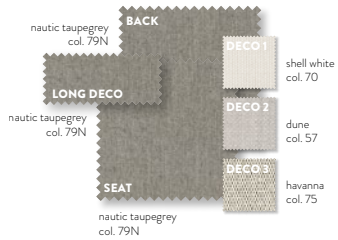

COMBO A6



COMBO A7



COMBO A8



CAT. B

COMBO B9

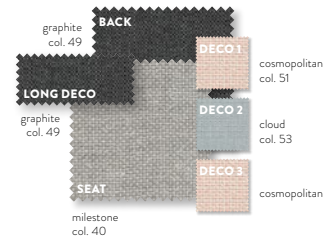

COMBO B10

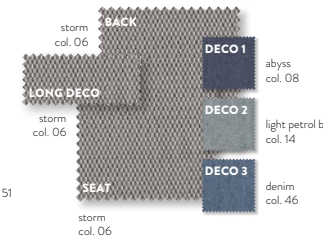

COMBO B11

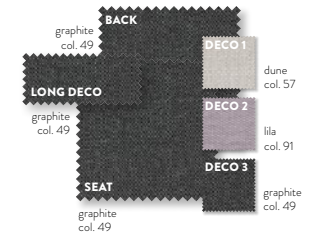

COMBO B12



COMBO B13



COMBO B14

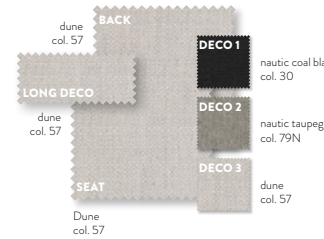

COMBO B15



COMBO B16



COMBO B17



COMBO B18



COMBO B19



COMBO B20



The best part of the day, **my outdoor moments**

manutti.com