

Molteni & C

45°/TAVOLINO — RON GILAD 2012

1—
3



Ron Gilad's new collection of furnishings, Grado°, underlines the designer's interest in basic geometric shapes. 45°/tavolino. Series of small tables with extra-light transparent crystal top, available in various sizes and marked by both a monochrome finish, american walnut or black oak, and by a bi-colour finish. Complex but essential shapes, "open box" table, of which we can only see the contours, able to integrate into all furnishing solutions with character.

FEATURES

Series of tables available in various sizes and finishes. They can have a top and a lower shelf.

DATASHEET

REGISTERED
DESIGN

IX.2018

WOOD STRUCTURE FINISHES

American walnut + yellow, red or blue (special colours) - all in American walnut - all in black oak

METALLIC STRUCTURE FINISHES

black chrome - pewter colour

LOWER SHELVES FINISHES

transparent extraclear glass - smoked glass - coloured glass in the Molteni colour range - eucalyptus (only for metal structure) - marble (black marquina/emperador dark/white Carrara/orient grey) Sahara noir marble - calacatta gold marble

UPPER SHELVES FINISHES

transparent extraclear glass
smoked glass

TECHNICAL INFORMATION

STRUCTURE

Extruded aluminium covered with wood veneer in Oak (*Quercus*) or American walnut (*Juglans nigra*) or anodised.

GLASS TOP

Tempered glass (5 mm thick) transparent extra clear, smoked, or painted in “Molteni Range” colours.

GLASS TOP WITH SIDES

Tempered glass thickness 5 mm transparent extra light. Gluing with UV polymerizable adhesives.

FEET

Chromed plastic element with non-slip rubber insert for floor placement.

MARBLE TOP

Marble in Range finishes with anti-stain, water-repellent treatments.

WOODEN TOP

Composite panel of MDF and sheet aluminium (1 mm thick), covered with Eucalyptus (*Eucalyptus globulus*) wood veneer.

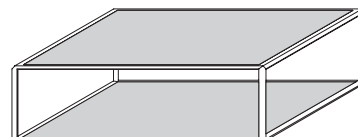
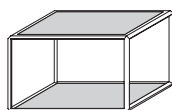
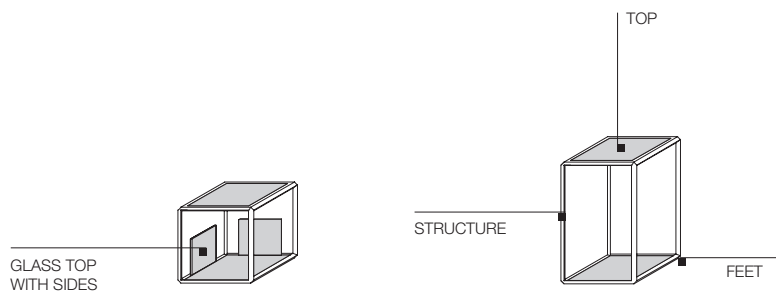

DATASHEET

REGISTERED
DESIGN

IX.2018

DIMENSIONS

Notes

- Tables cannot be stacked and fastened together
- The upper shelf can only be in glass
- Small tables W 36,4 x D 36,4 are also available with a glass top with sides.

floor standing small tables structure

GXT1

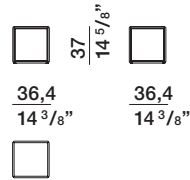

GXT2

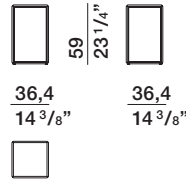

GXT3

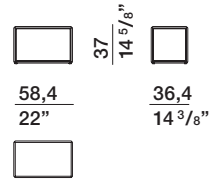

GXT4

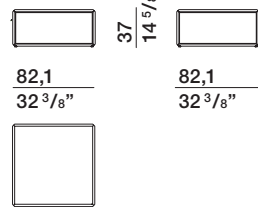

GXT6

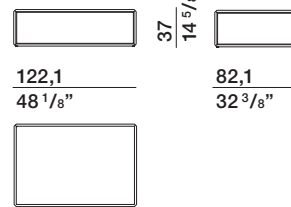

GXT5

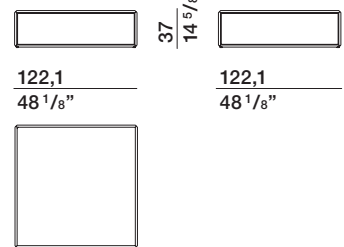

shelves

marble shelves th 1,5-5/8" and eucalyptus th 1,1-3/8" can only be used for the lower part

W 36,4 D 36,4

glass top with sides

for structure (only the lower)

GXR11

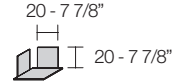
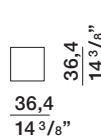

GXR13

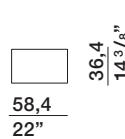

GXR14

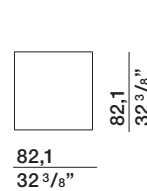

GXR16

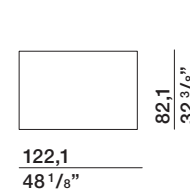

GXR15

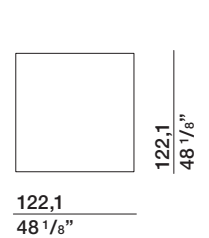

Composite small tables

floor standing small tables with shelves

WGXT1

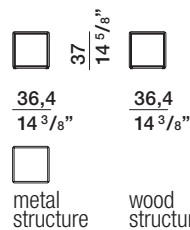

WGXT2

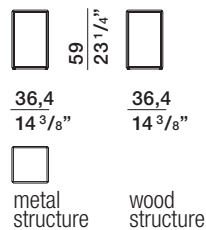

WGXT3

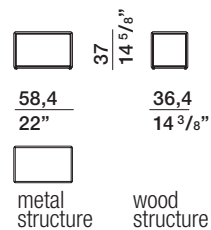

WGXT4

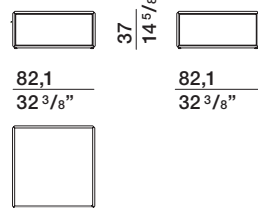

WGXT6

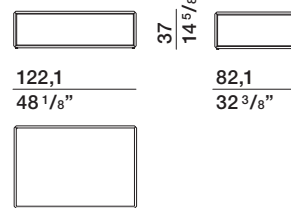

WGXT5

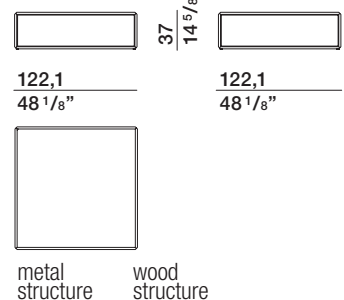

DATASHEET

REGISTERED
DESIGN

IX.2018

Molteni & C

FINISHES MOLTENI&C RANGE

IX.2018

	MATT LACQUER	GLOSSY LACQUER	COLOURED GLASS	ETCHED COLOURED GLASS	CARTAPAGLIA LACQUERED <i>only Gliss Master</i>	STOPSOL GLASS TRANSPARENT STOPSOL GLASS
CHALK WHITE	•	•	•	•	•	
PEARL	•	•	•	•	•	
SILICA	•	•	•	•	•	
SAND	•	•	•	•	•	
DOVE GREY	•	•	•	•	•	
PLATINUM	•	•	•	•	•	
DUNE	•	•	•	•	•	
CLAY	•	•	•	•	•	
DOLOMITE GREY	•	•	•	•	•	
COPPER	•	•	•	•	•	
RUST	•	•	•	•	•	
RUBY	•	•	•	•	•	
CARAMEL	•	•	•	•	•	
MOKA	•	•	•	•	•	
MUSTARD	•	•	•	•	•	
LIGHT BLUE GREY	•	•	•	•	•	
PEWTER COLOUR	•	•	•	•	•	
ANTHRACITE	•	•	•	•	•	
BLACK	•	•	•	•	•	
STOPSOL						•
LESSLESS RED	•					
	only matt lacquer					

Molteni & C

FINISHES MOLTENI&C RANGE

IX.2018

WOODS

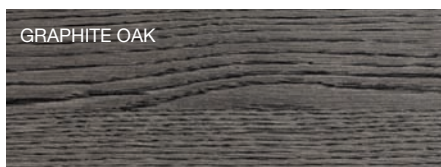
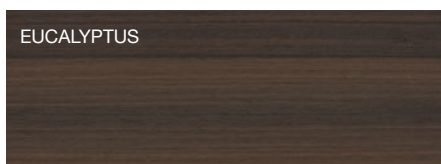

MARBLES

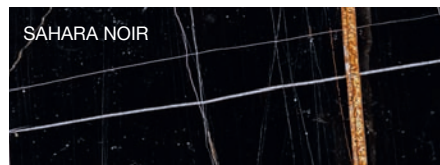
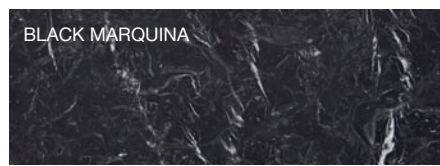
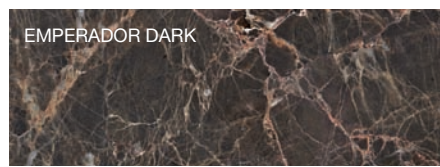
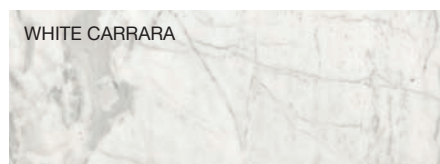

METAL PARTS

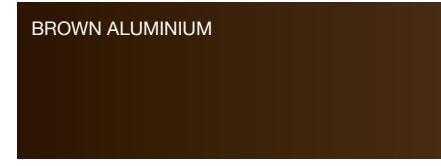
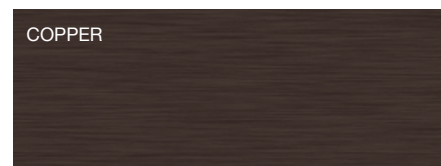
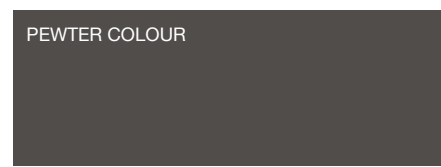
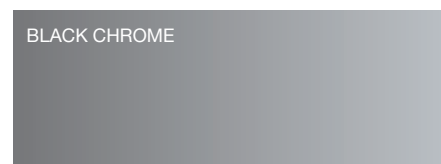

The finishes shown are indicative and refer to the entire production range. We recommend that you consult the "Colour Range" samples which shown the complete range of finishes, including those not shown here. Molteni&C reserves the right to modify the range without warning.

Molteni & C

FINISHES MOLTENI&C RANGE

IX.2018

MELAMINE FRONT
GLISS MASTER

CARTAPAGLIA WHITE



CARTAPAGLIA ANTHRACITE



CARTAPAGLIA SILICA



GRAFFIATO SILICA



GRAFFIATO BRONZE



SILK DOVE GREY



SILK SILICA



SILK CHALK WHITE



MELAMINE STRUCTURE
GLISS MASTER

WHITE SHANTUNG



GREY SHANTUNG



MELAMINE STRUCTURE
GLISS MASTER, MASTER DRESSING,
GLISS WALK-IN

SILVER CEMBRAN



LARIX DARK

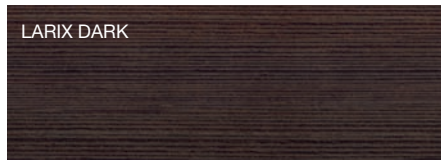

MELAMINE STRUCTURE
GLISS MASTER, MASTER DRESSING

WHITE



ECO SKIN

IVORY



HEMP



MINK



DARK BROWN

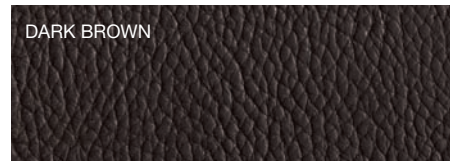

GREY



FINE GRAIN

FINE GRAIN

