



P.O. Box 68323, Bryanston 2021
200 Cussonia Park, 3 Ridge Road,
Laser Park, Honeydew, South Africa.
Tel: (011) 794-6311 • Fax: (011) 794-6233

INSTALLATION INSTRUCTIONS



INSTALLATION WARNING:

1. It is important that all K9 Racks and accessories are correctly attached (fastened) and secured to your vehicle.
2. Negligent installation of the K9 Rack and accessories could lead to an unfortunate vehicle accident. Furthermore injure and cause bodily harm or even lead to the demise of other folk.
3. Remember you are personally responsible in securing and checking the installation of your K9 Rack on your vehicle.
4. Once fitted the K9 Rack installation should be checked on a regular basis and if need be adjusted or secured.
5. Before you commence installation of your K9 Rack it is imperative that you read the instructions thoroughly to understand and be prepared for the assembly.
6. Should you not fully understand the assembly and installation instructions of the K9 Rack and you are apprehensive that you do not have the technical or mechanical know-how it would be in your interest to have the K9 Rack installed by a qualified professional at a garage or fitment centre.
7. Lastly it is extremely important that your equipment including the weight of the K9 Rack does not exceed your vehicles maximum roof load specifications.
8. In order to obtain your vehicle specifications one would need to contact your vehicle manufacturer or distributor or look in your service book provided with your vehicle.
9. It is very important that at all time should you need to drill through the roof of the vehicle, a stop of some sorts is placed on the drill bit to prevent it from penetrating the vehicles roof too far as damage can be done to the inner roof lining and air bag system.
10. A small bead of silicone should be applied to all holes in the roof of the vehicle.



SECTION 1: MOUNTING A K9 ROOF RACK ONTO A VEHICLE WITH GUTTERS, RAIN CHANNEL INCLUDING THE JEEP JL.

GETTING STARTED:

10mm spanner, wrench
13mm spanner, wrench
4mm allen key
5mm allen key
6mm allen key
Measuring tape

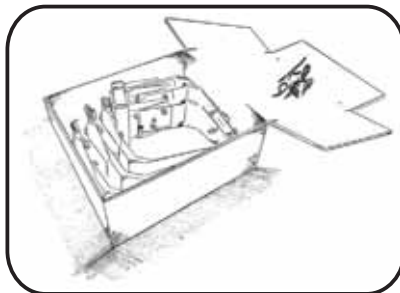

Once K9 leg box is opened, place in an accessible position.

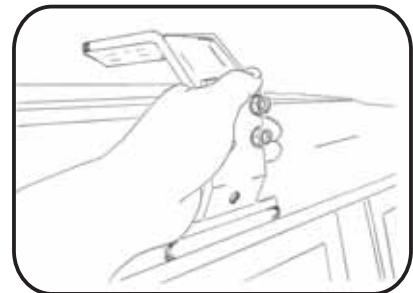

Remove leg from box, place in the gutter (rain channel) of the vehicle in order to obtain the correct height.

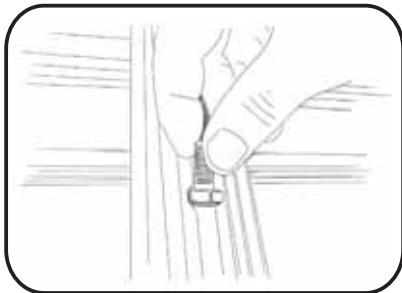

Remove rack from box, turn upside down and slot bolts into position onto slide rail.

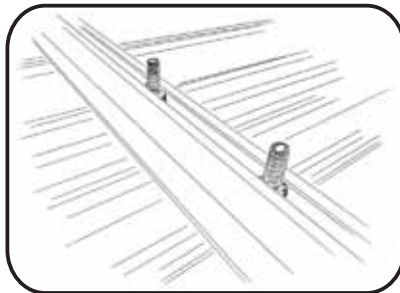

Two bolts per side on each slide rail that the legs are to be mounted to.

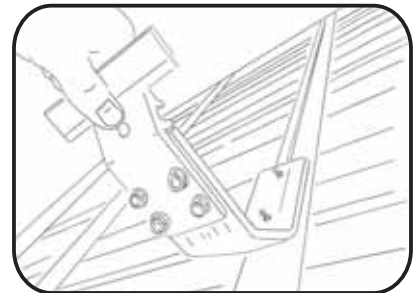

Place legs on slide rail into position.

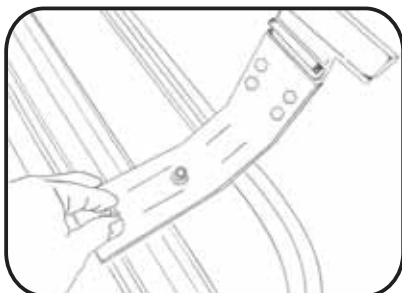

Thread nyloc nuts onto bolts.

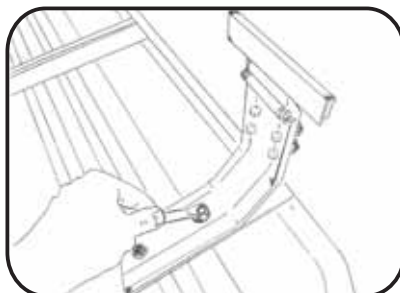

Secure with 13mm spanner/wrench but leave loose that they can still move.

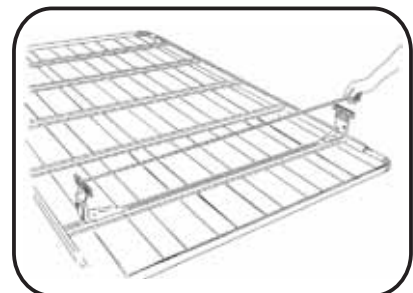

Use a measuring tape and adjust roof rack legs to the measurement required.

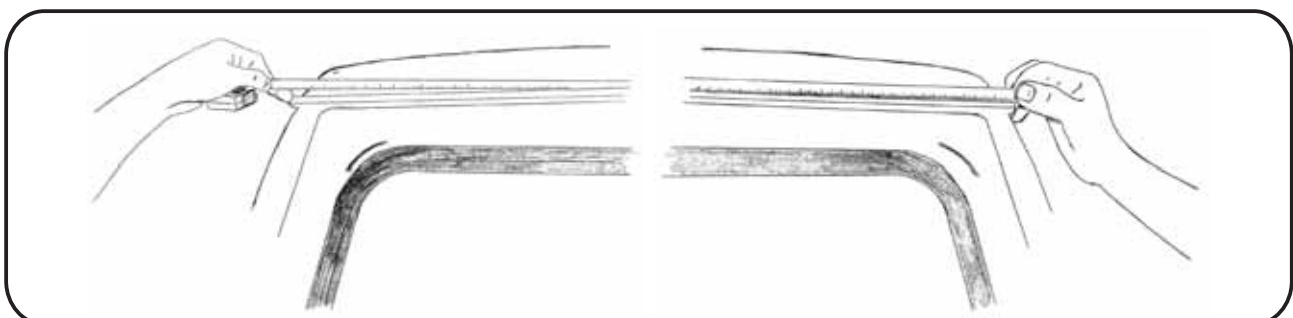

Ask someone to help measure the gutter (rain channel) width of the vehicle with a measuring tape.

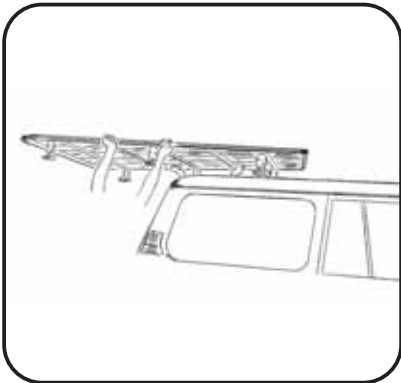

Turn K9 roof rack right side up and walk it over vehicle.

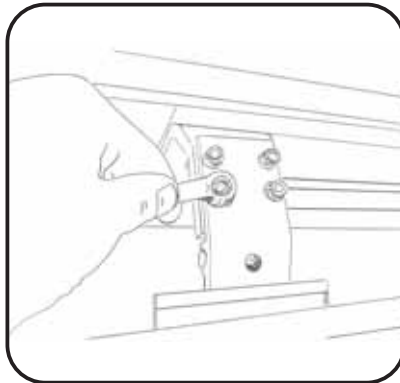

Adjust legs to desired angle and secure.

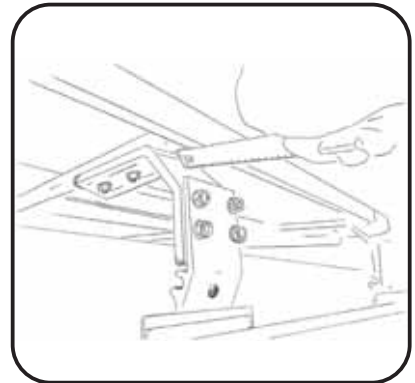

In order to centralize a K9 rack on vehicle use a measuring tape.

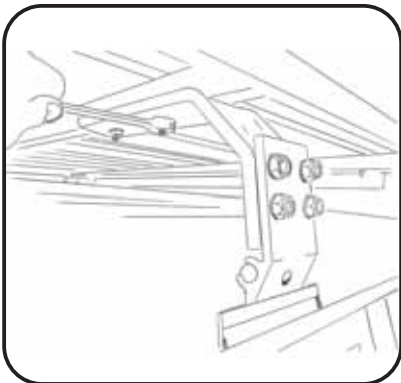

Fully tighten nyloc nuts with 13mm spanner/wrench on slide rail bolts.



Place K9 clamp in position and hand tighten. This should be done to all clamps provided.

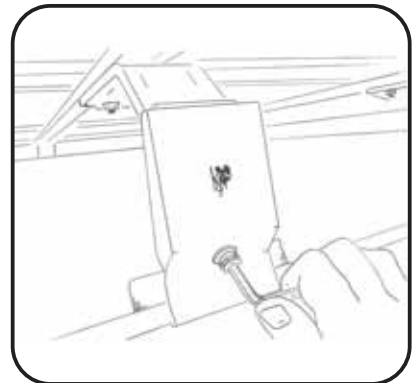

Systematically tighten K9 clamp with 6mm allen key. Do not over tighten.

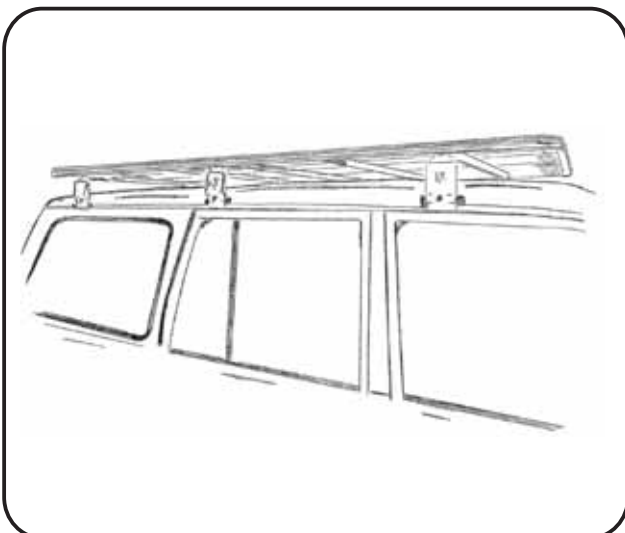

Make sure all bolts and nuts are secure before driving off.



JOB WELL DONE!

SECTION 2: MOUNTING A K9 ROOF RACK ONTO A VEHICLE WITHOUT GUTTERS, RAIN CHANNELS OR WITH OME BARS:

GETTING STARTED:

10mm spanner, wrench
12mm spanner, wrench
13mm spanner, wrench
4mm allen key
5mm allen key
Measuring tape



Once the K9 leg box is opened, place in an accessible position.

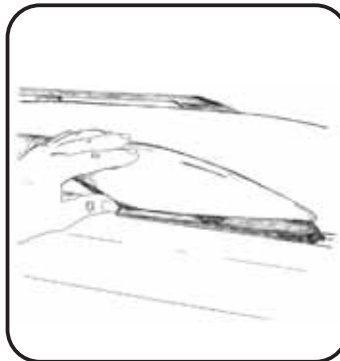

In order to remove plastic covers on OME factory bars to access mounting bolts push down and pry sides away to unclip

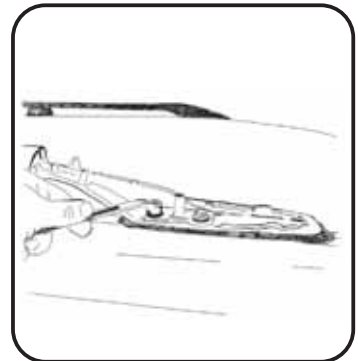

Remove bar with 12mm spanner/wrench.



It is important to put silicone on the holes in the roof before placing the spacers down.

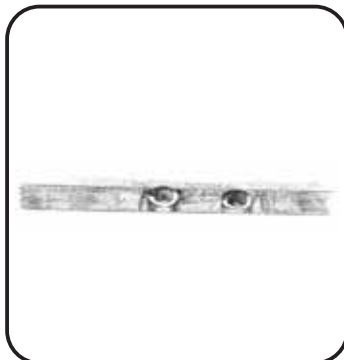

Place aluminium spacers provided into slots and align with holes.

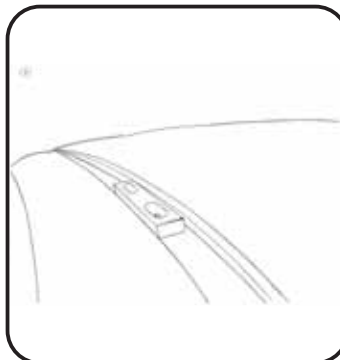

Or the slotted spaces which ever are supplied with the kit.

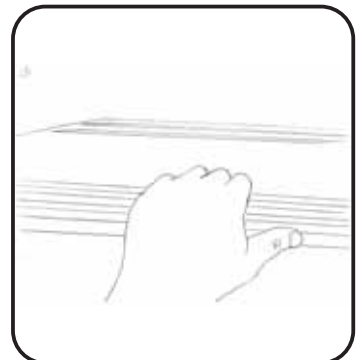

Place K9 track down on vehicles roof.

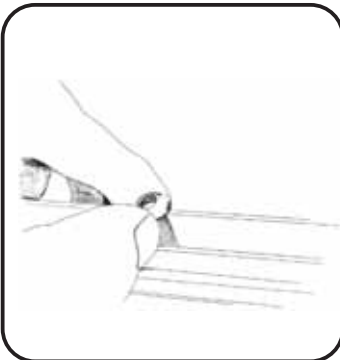

Place rail into correct position and thread in bolts.

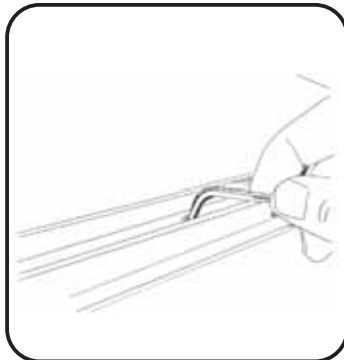

Tighten with 5mm allen key. Tighten each bolt systematically.

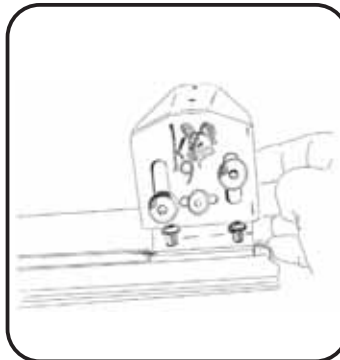

Slide K9 legs into rail.

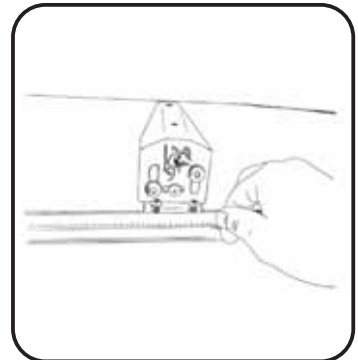

By using a tape measure adjust distance to slide rails on K9 rack.



Remove rack from box, turn upside down, slot bolts into position onto slide rail.

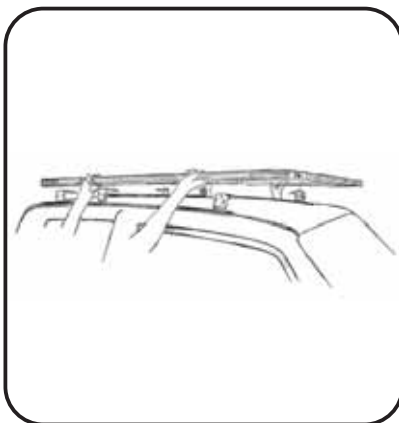

Turn K9 roof rack right side up and walk it over vehicle.

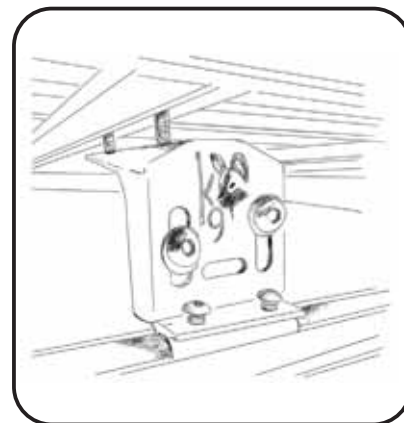

Align K9 legs with bolts on roof rack slide rails.

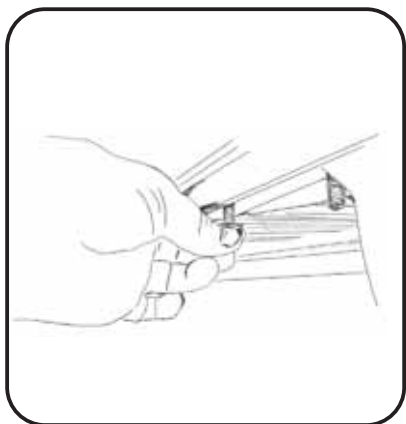

Thread nyloc nuts onto bolts.

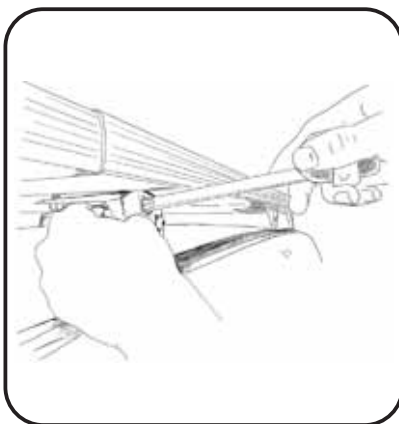

In order to centralize K9 rack on vehicle, use a measuring tape.

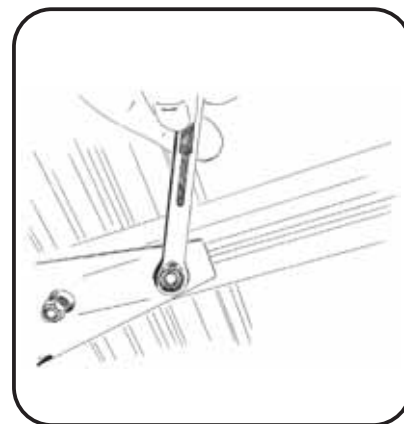

Fully tighten nyloc nuts with 13mm spanner/wrench on slide rails.

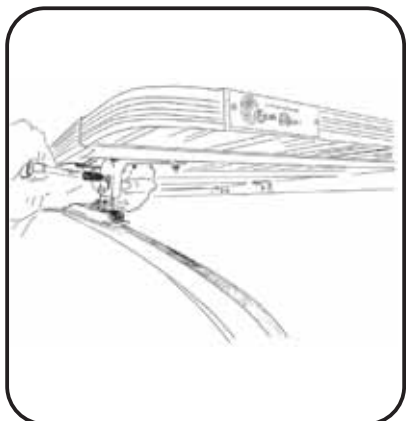

Adjust leg to height required and tighten.

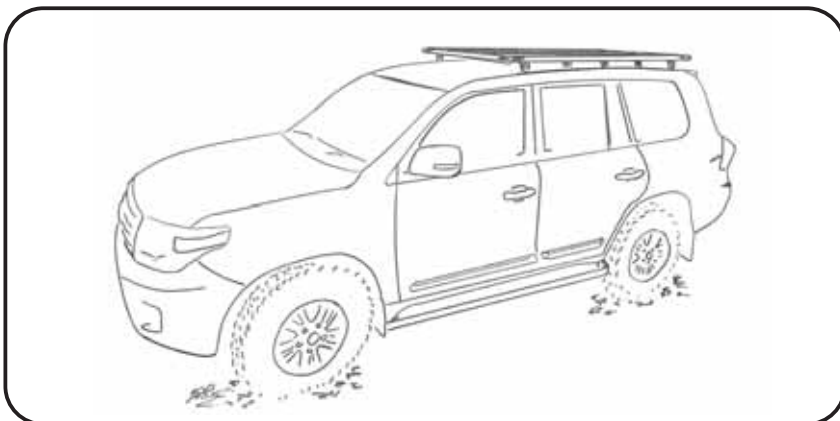

JOB WELL DONE!

MOUNTING RAILS ONTO A CANOPY OR JEEP JK 2015 MODEL. REFER TO SECTION 2 WITH REGARDS TO MOUNTING THE RACK:

GETTING STARTED:

- 10mm spanner
- 4mm allen key
- Blade or knife
- 6.5mm drill bit
- 12mm drill bit
- Drill
- Marking pen
- Tape measure

For ease of fitting - remove canopy from vehicle

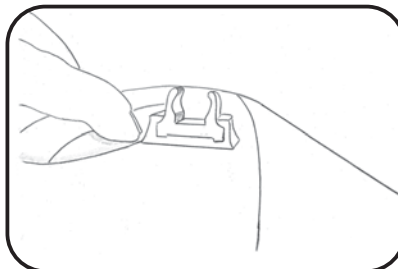

Place the rail roof up against inside of outer rib at the back of Jeep.

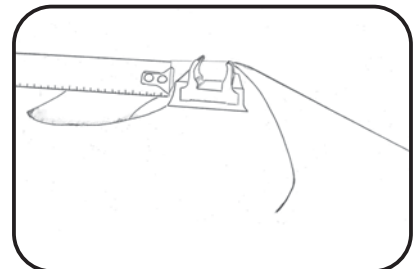

Measure with a tape 7mm from top of rib.

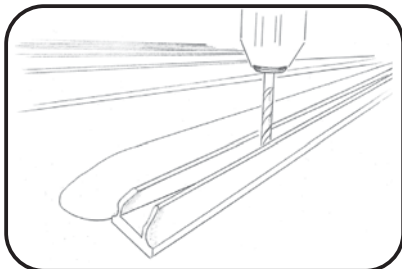

Drill small pilot hole first.

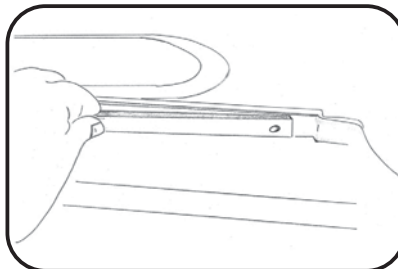

Check in the inside to make sure that holes are in the correct position in the inside the plates should fit onto the flat recess.

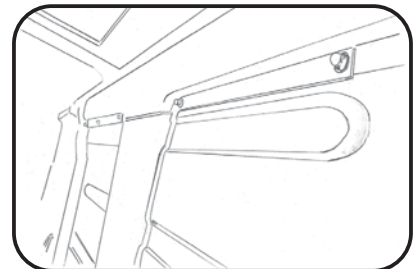

Finish drilling and secure plates and rails and place plastic caps on nuts.

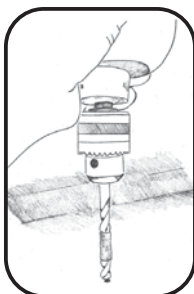
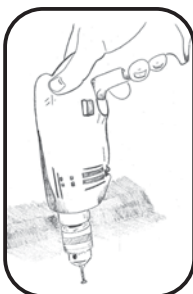

Using a small drill bit 5mm or smaller drill a pilot hole. Change drill bit to the finished hole required. Place tape around drill bit in order to stop the bit going too deep.

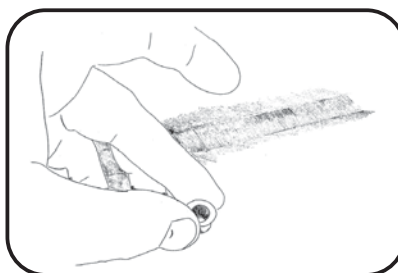

Rubber riv nuts should be used in the front.

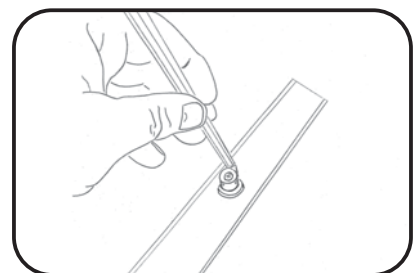

Before securing turn rail upside down, mark hole to be cut with a marking pen draw around rubber riv nut.

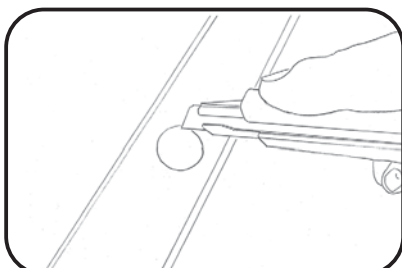

Cut hole out in rail rubber to accommodate rubber riv nut. Hole can be cut round or square.

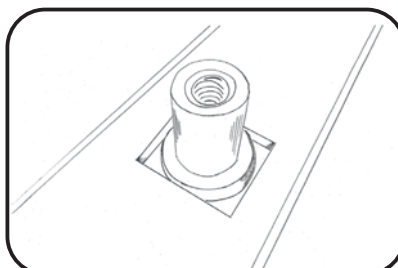

Make sure rubber riv nut fits in hole. Turn rail over and secure to roof.

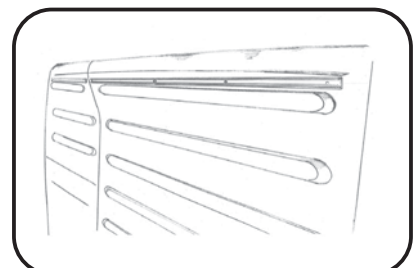

This allows rail to sit flush with roof. **JOB WELL DONE!**

(SHOULD YOU HAVE A OLDER MODEL JK PLEASE CONTACT YOUR NEAREST DISTRIBUTOR FOR INSTRUCTIONS)

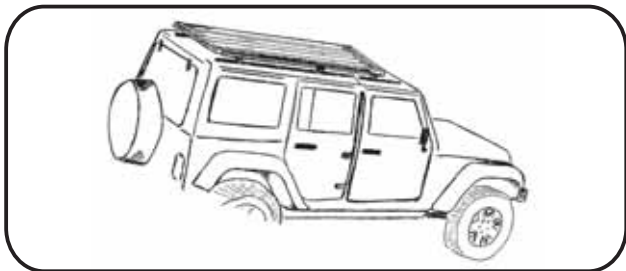

In order to mount rack refer to section 2.

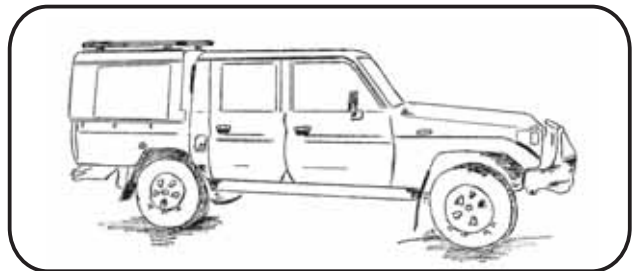

JOB WELL DONE!

SECTION 4: MOUNTING LEGS ONTO A DISCOVERY 3 OR 4 REFER TO SECTION 2 WITH REGARDS TO MOUNTING THE RACK:

GETTING STARTED:
13mm spanner/wrench
Tape measure
4mm allen key
5mm allen key

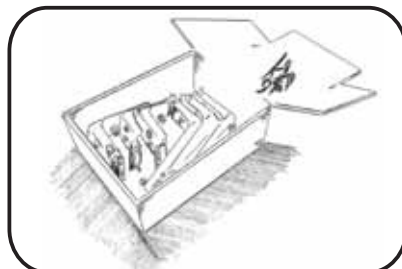

Once K9 leg box is opened, place in an accessible position.

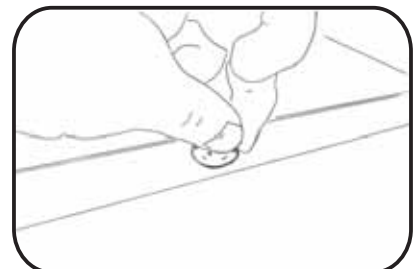

Remove plastic cap in rubber roof strip above front doors.

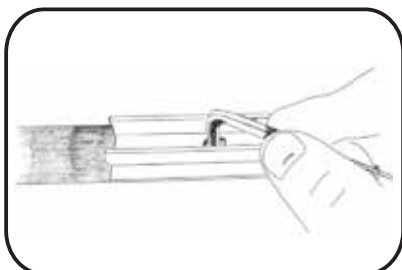

Secure rail with 4mm allen key down into position.

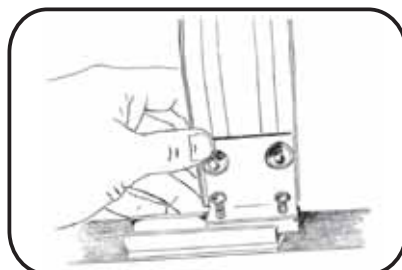

Slide front leg onto rail.

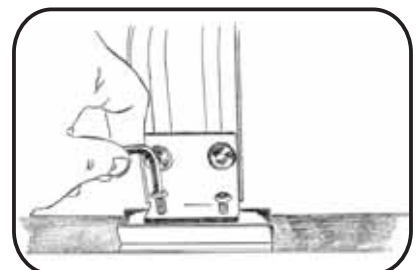

Adjust front leg so as it is level with vehicles roof and secure with 4mm allen key.

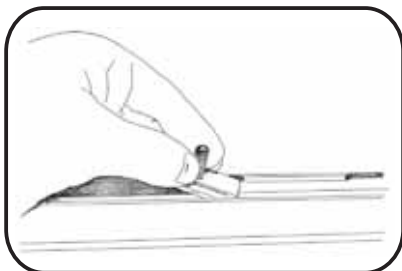

Insert 4 K9 roof rack slides into OME bars each side.

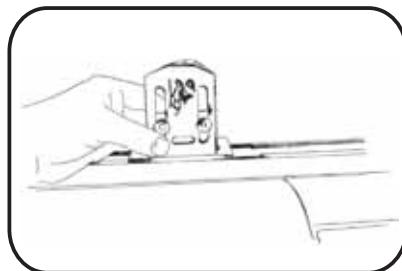

Attach K9 roof rack legs and secure with 13mm spanner/wrench but leave so that they can still move. In order to mount rack refer to section 2.

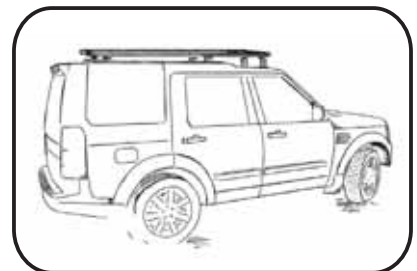

JOB WELL DONE!

Mounting K9 rails onto a VW Amarok

GETTING STARTED:

Measuring tape
Small tube of silicone
4mm allen key
Flat screwdriver

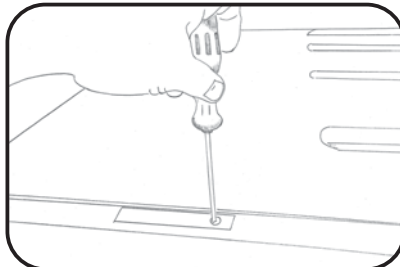

Turn lock in plastic cover plate on roof with flat screwdriver.

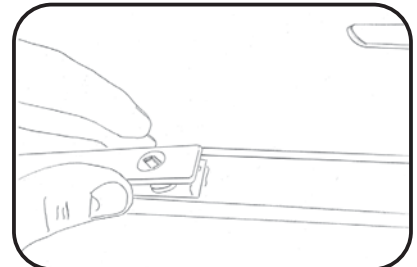

Lift plastic cover plate out to remove.

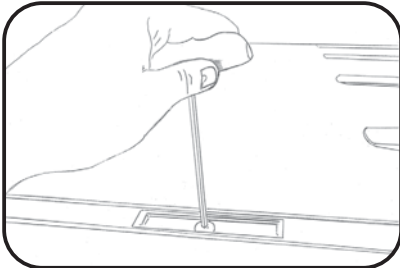

Remove bolts provided with allen key.

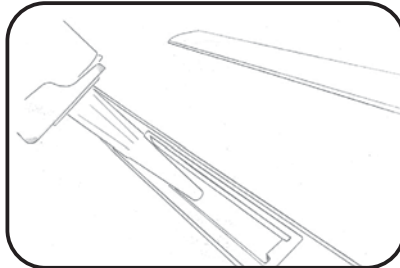

Insert a small amount of silicone into hole.

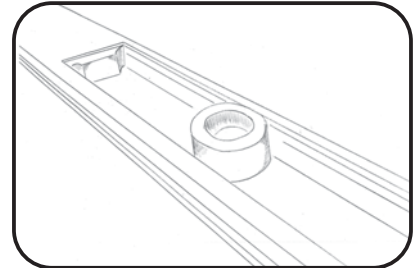

Place aluminium spacer provided into slot.

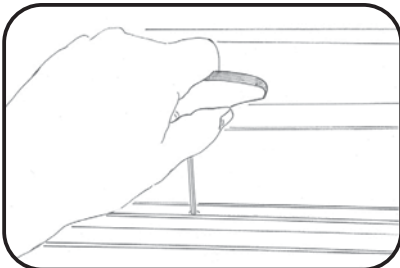

Fasten K9 rail down with bolts provided at the back first.

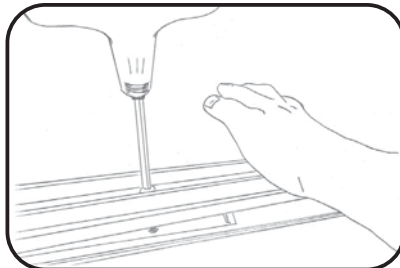

Fasten the K9 rail down with bolts provided at the front by pushing down on K9 rail.

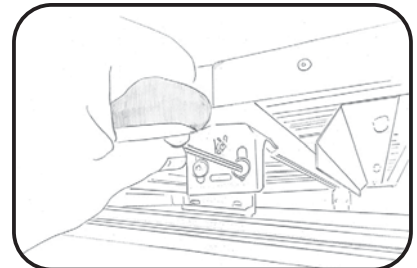

Fit roofrack to rails as per Section 2.

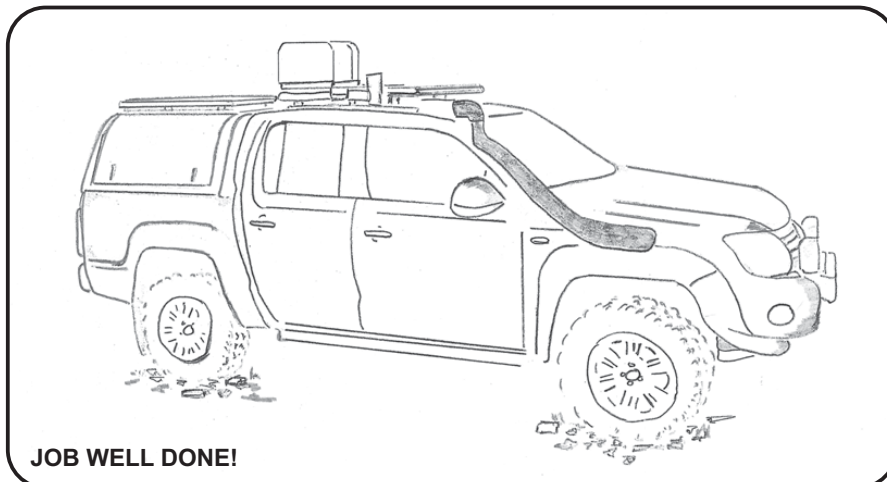

**Mounting K9 rail onto single and double cab vehicles without OEM hole inserts provided.
For example the Toyota Hilux Vego and Tundra.**

GETTING STARTED:

- Pencil
- Hacksaw
- Sharp knife
- 5mm drill bit + drill
- Pop rivet gun
- Vacuum cleaner
- 4mm allen key
- Small tube Silicone

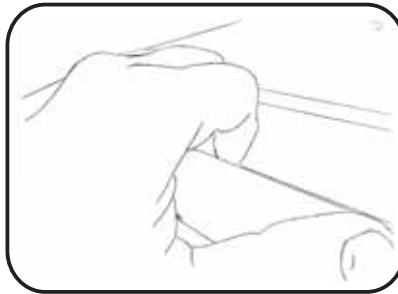

Pry rubber strip from roof.

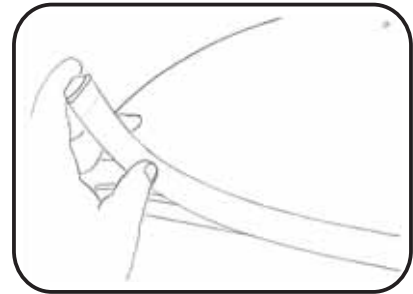

Fold rubber strip back and leave attached at the back.

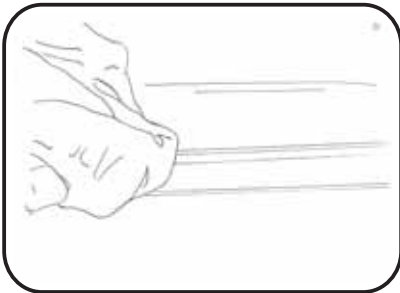

Clean slot after removing rubber strip.

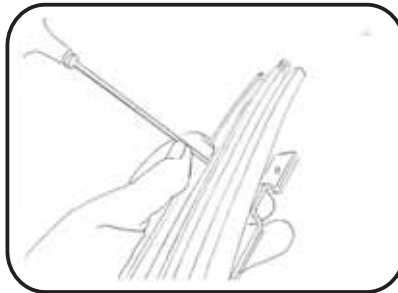

Fasten bracket to the track with bolts provided.

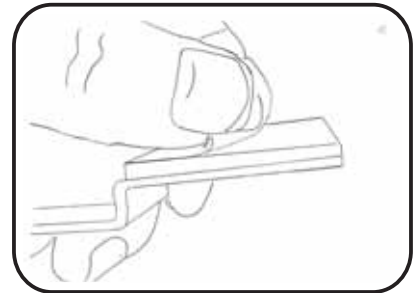

Remove plastic strip from adhesive strip.

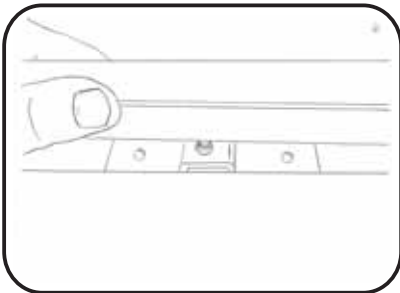

Place track in mounting position in slot and press down to locate brackets.

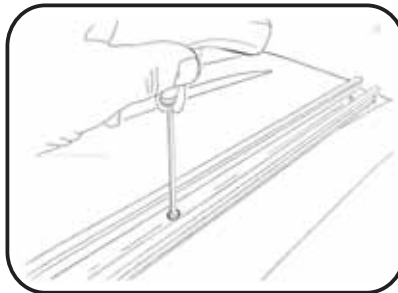

Remove bolts once in position.

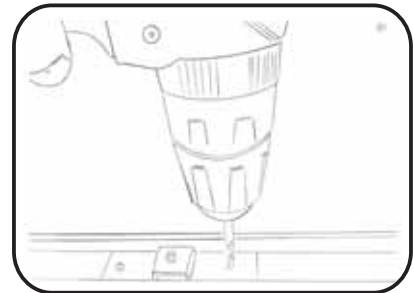

Drill holes with a 5mm drill bit. Take care not to drill too deep.



Vacuum out all loose particles.

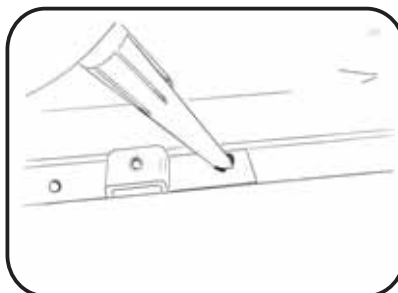

Place small bead of silicone around holes.

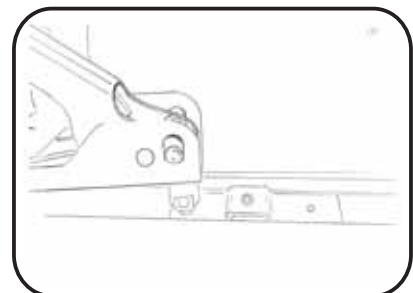

Pop rivet bracket in place with pop rivet gun.

**Mounting K9 rail onto single and double cab vehicles without OEM hole inserts provided.
For example the Toyota Hilux Vego and Tundra.**

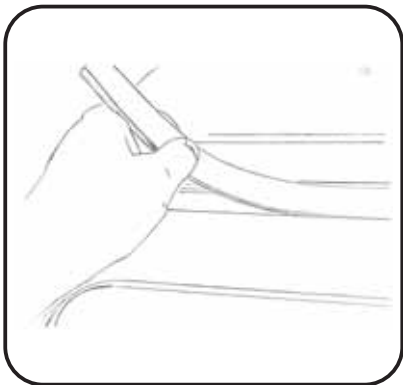

Replace rubber strip

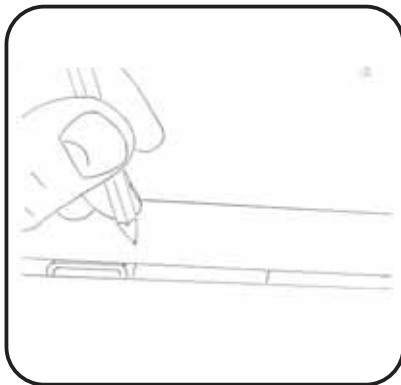

Draw a line where you need to cut rubber strip.

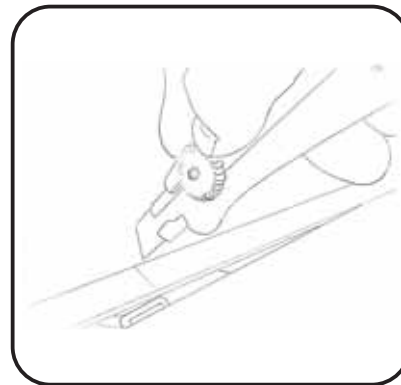

Cut the rubber strip with a sharp knife.



A straight edge can be used to assist.

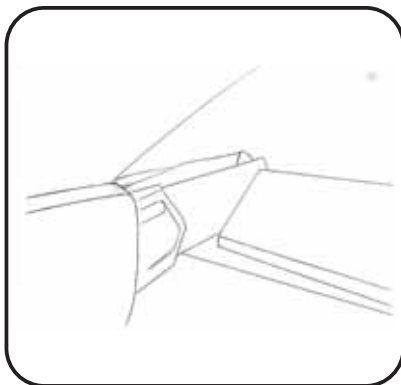

Cut all the way through the rubber strip.

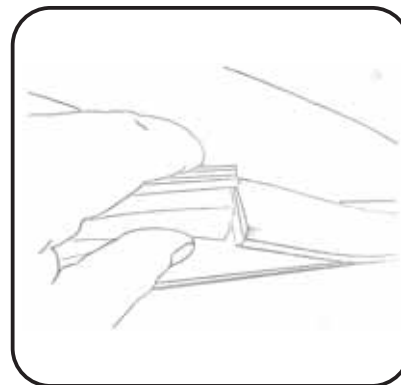

Twist strip to break off steel insert once cut with knife.

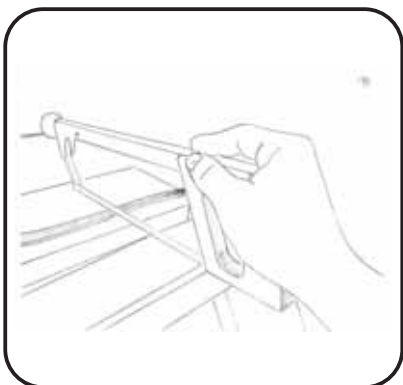

A hacksaw can also be used instead of a knife. But we recommend that a polystyrene block or similar is used to protect the roof of the vehicle.

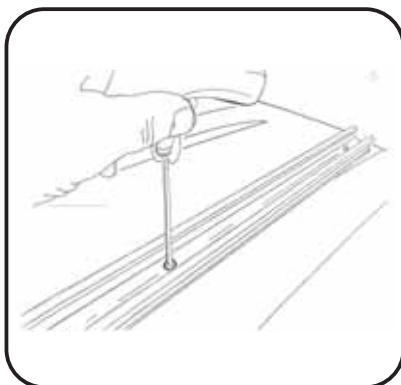

Fasten track down onto brackets and refer to section 2 in order to mount rack.

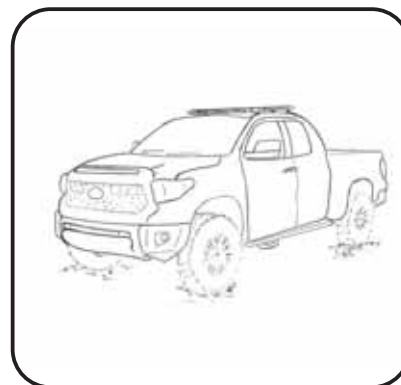

JOB WELL DONE!

FORD RANGER 2013 ON TRACK FITTING INSTRUCTIONS

GETTING STARTED:

Pencil
Hacksaw
Sharp knife
5mm drill bit + drill
Pop rivet gun
Vacuum cleaner
Small tube silicone
13mm spanner wrench
Tape measure

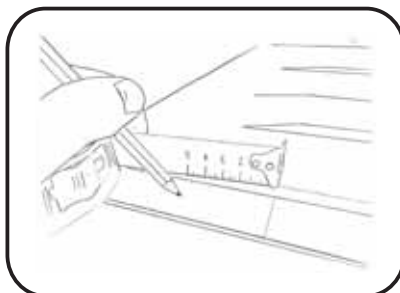

Measure 50mm back from prominent line in roof rubber.

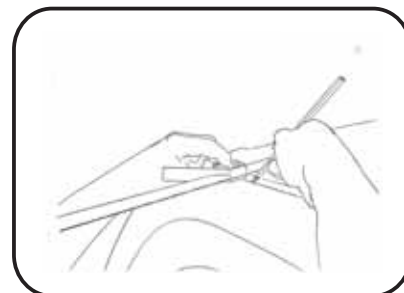

Draw a line with a pencil to mark the spot.

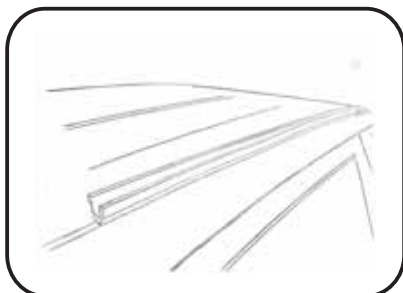

Place the track onto the roof align with the mark just made check you are happy with the position of the track.

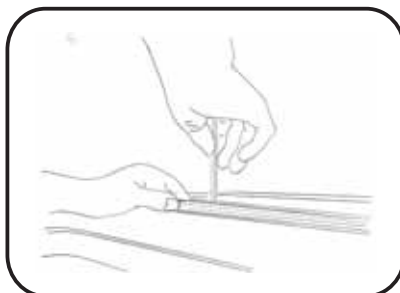

This should be aligned with pencil mark at the back.

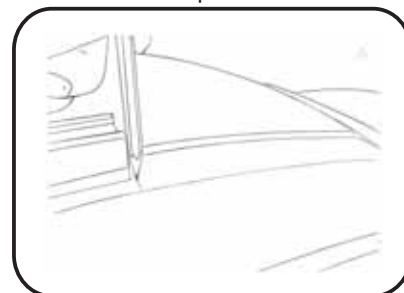

Mark the rubber strip in the front in order to cut out rubberstrip to accommodate track.

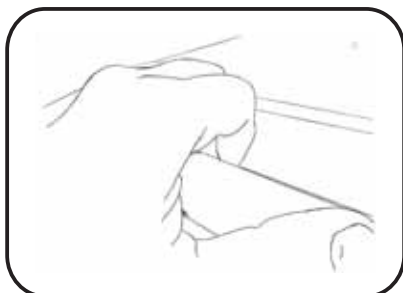

Pry rubber strip from roof.

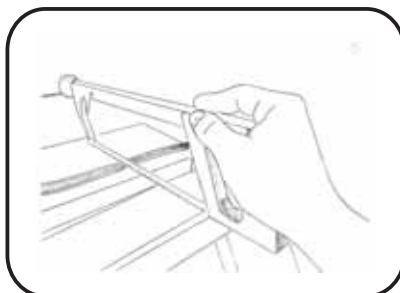

Cut rubber strip with a hacksaw using a polystyrene block or similar to protect vehicle roof when cutting.

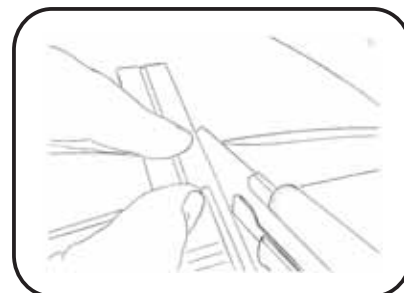

Alternatively a sharp knife can be used with a straight edge.

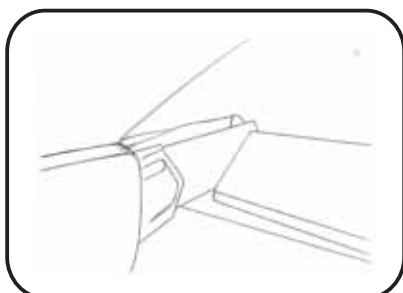

Cut through the rubber until you hit the steel insert.

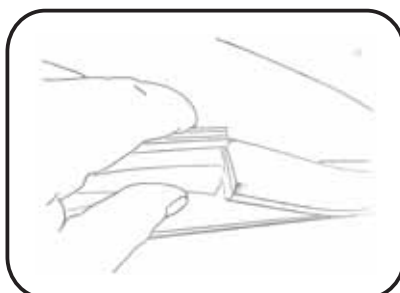

Twist strip to break off steel insert once cut with knife.

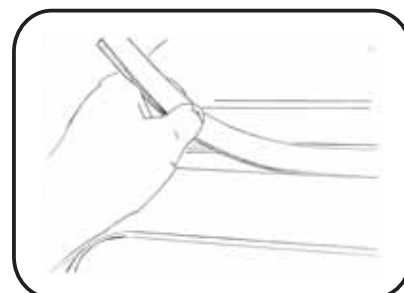

Remove rubber strip from roof by pulling upwards.

FORD RANGER 2013 ON TRACK FITTING INSTRUCTIONS

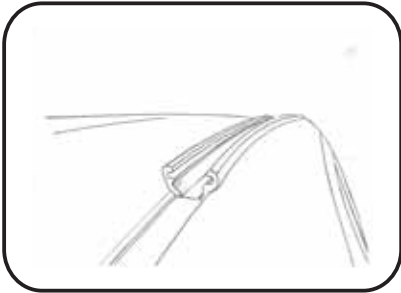

Place track down in slot now created.

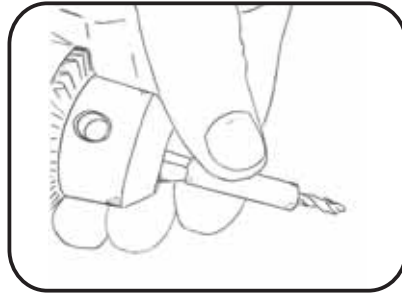

It is important to place tape around drill bit in order to stop the drill going too deep the drill should only protrude a maximum of 10mm

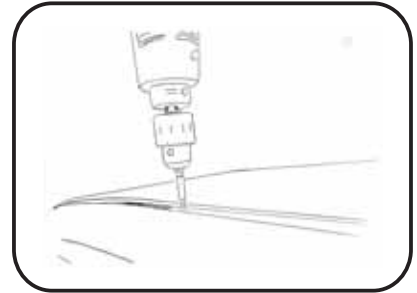

Mark the position of the holes with a drill through the track, remove the track and finish drilling.



Vacuum out all loose particles

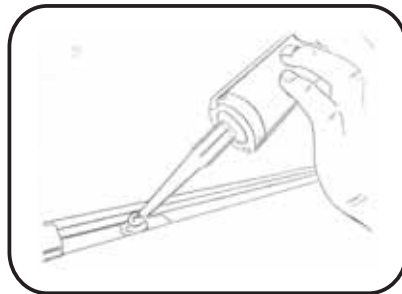

Place a small bead of Silicone around holes.

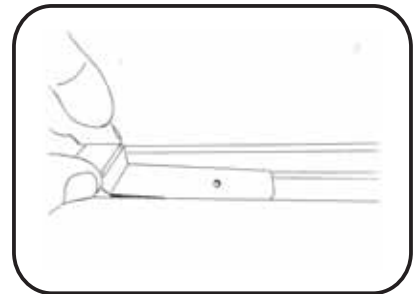

Place rubber cover plate down in slot and then track will go on top.

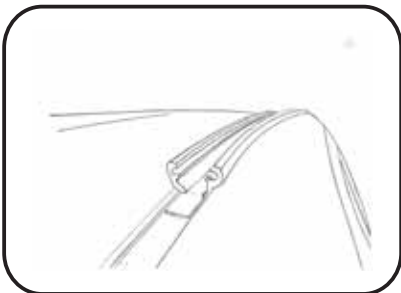

Track in slot with rubber strip cover plate.

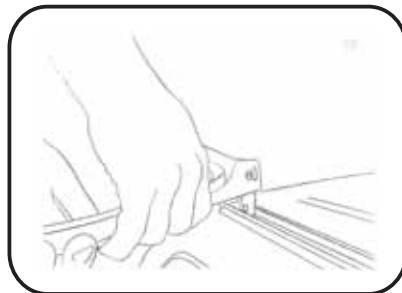

Poprivet track in place with poprivet gun.

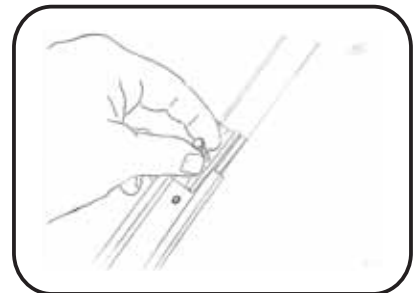

Slide mounting plates into track.

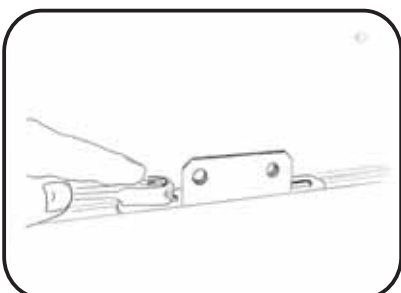

Attach K9 foot and adjust to align with roof rack to be fitted secure with 13mm spanner wrench

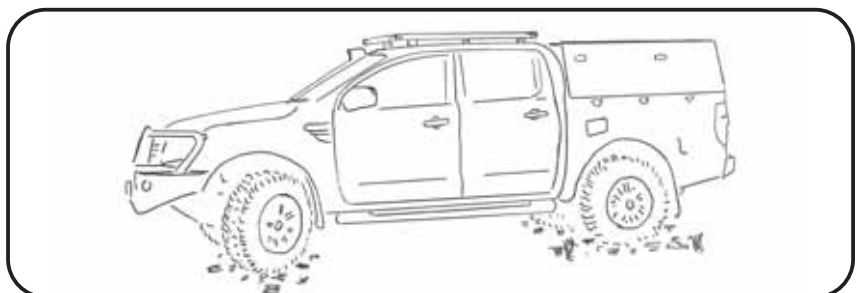

JOB WELL DONE!

2016 HILUX REVO TRACK FITTING INSTRUCTIONS

GETTING STARTED:

Pencil
Hacksaw
Sharp knife
5mm drill bit + drill
Pop rivet gun
Vacuum cleaner
Small tube silicone
13mm spanner wrench
Tape measure

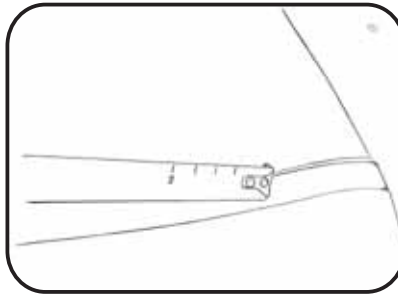

Measure 50mm on rubber strip from prominent line in roof rubber.

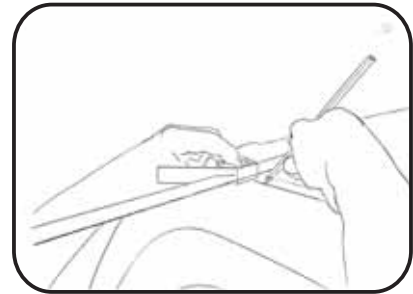

Draw a line with a pencil to mark the spot.

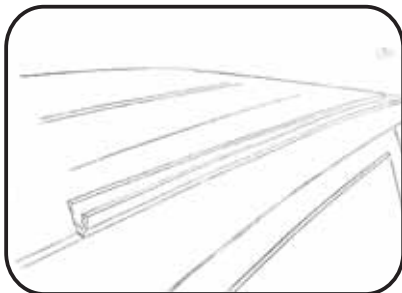

Place the track onto the roof align with the mark just made check you are happy with the position of the track.

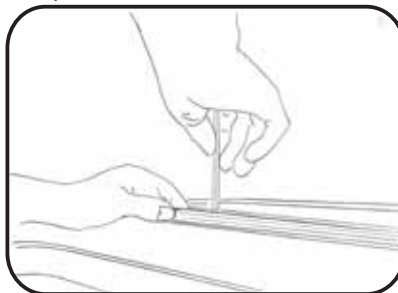

This should be aligned with pencil mark at the back.

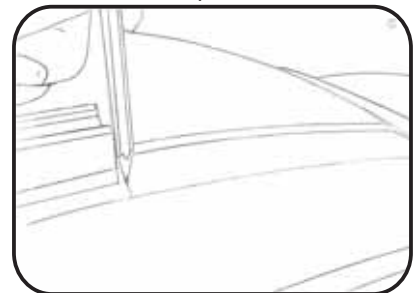

Mark the rubber strip in the front in order to cut out rubberstrip to accomodate track.

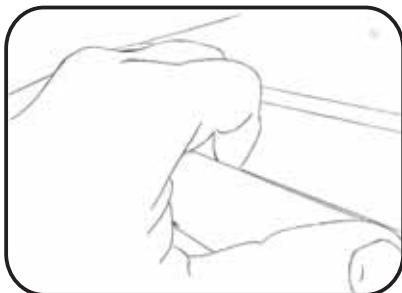

Pry rubber strip from roof.

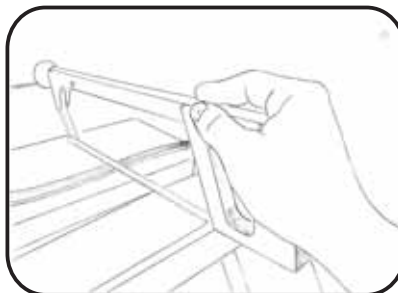

Cut rubber strip with a hacksaw using a polystyrene block or similar to protect vehicle roof when cutting.

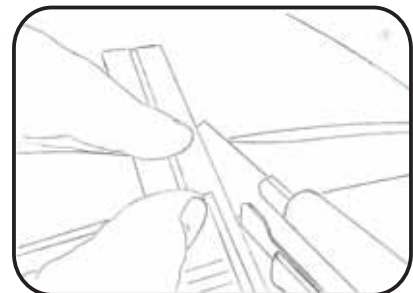

Alternatively a sharp knife can be used with a straight edge.

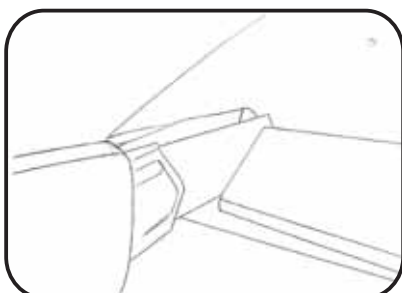

Cut through the rubber until you hit the steel insert.

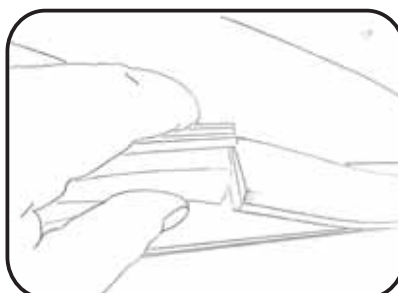

Twist strip to break off steel insert once cut with knife.

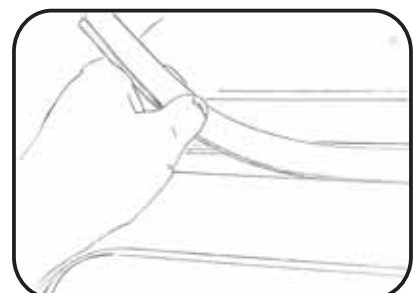

Remove rubber strip from roof by pulling upwards.

2016 HILUX REVO TRACK FITTING INSTRUCTIONS

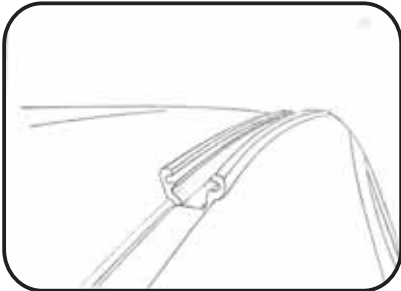

Place track down in slot now created.

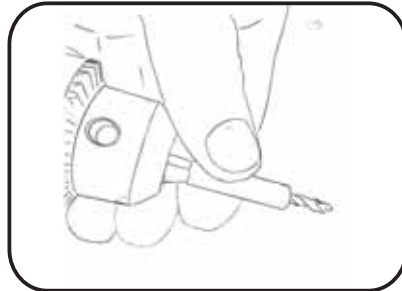

It is important to place tape around drill bit in order to stop the drill going too deep, the drill should only protrude a maximum of 10mm

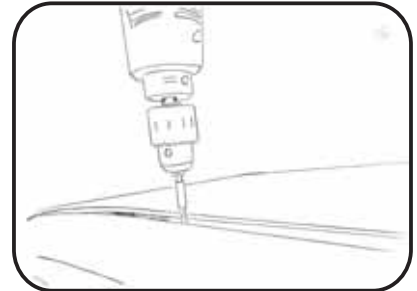

Mark the positions of the holes with a drill through the track, remove the track and finish drilling.



Vacuum out all loose particles.

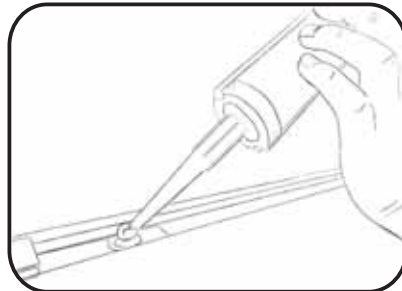

Place a small bead of silicone around holes.

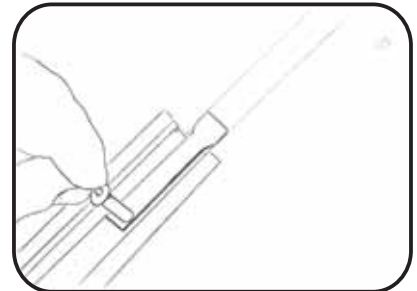

Put the poprivets in place as with rubber strip cover plate.

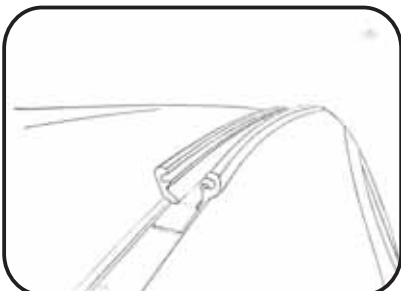

Track in slot with rubber strip cover plate.



Poprivet track in place with poprivet gun.

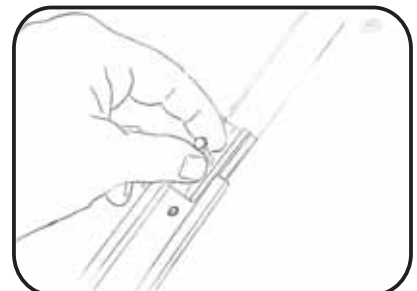

Slide mounting plates into track.

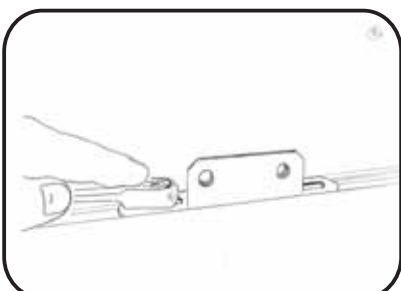

Attach K9 foot and adjust to align with roof rack to be fitted secure with 13mm spanner wrench.

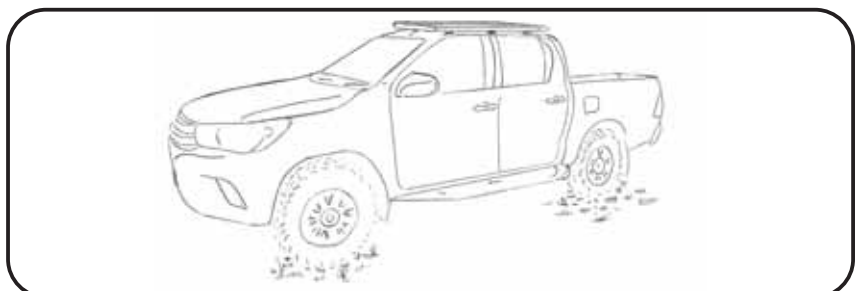

JOB WELL DONE!

GETTING STARTED:

10mm Socket Wrench
 13mm Spanner Wrench
 5mm Allen Key
 Cloth

Mounting K9 rail onto a Suzuki Jimny
Refer to section 1 for 2019 Jimny rack
mounting instructions.

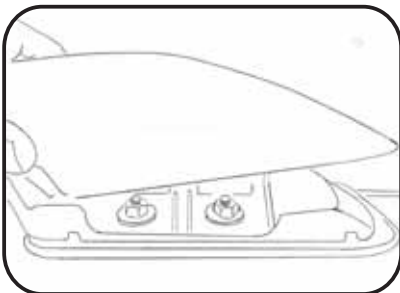

Unclip and remove plastic cover caps.

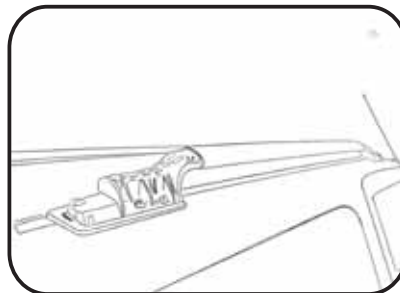

OEM bars once plastic covers have been removed.



Use a 10mm Socket Wrench to loosen securing nuts.

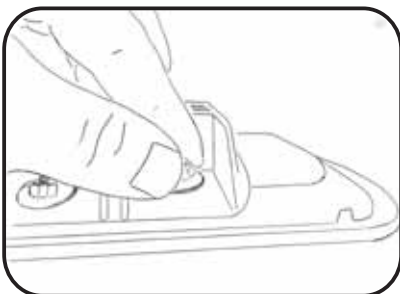

Remove and keep in a safe place as these will need to be used again.

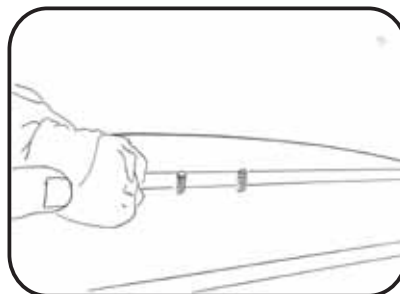

Wipe off the vehicles roof with a cloth.

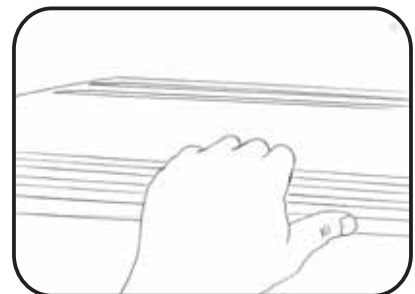

Place K9 track down on vehicles roof.



The K9 track will curve upwards once placed.

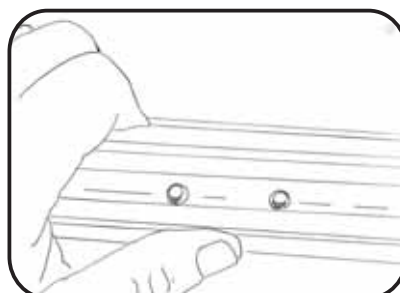

Align holes in the K9 track with studs on vehicles roof.

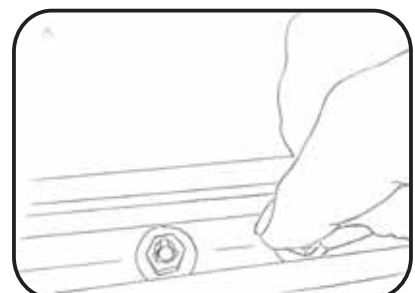

Secure with nuts, remove and hand tighten.

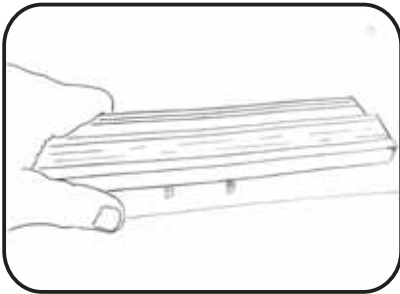

Press downwards to align.

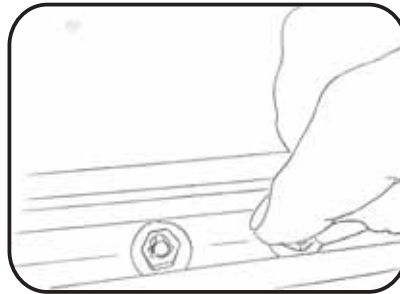

Secure with nuts removed and hand tighten.

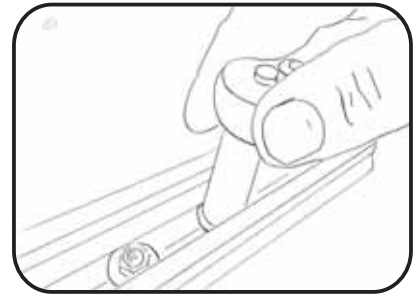

Tighten nuts with 10mm Socket wrench at the front and back.

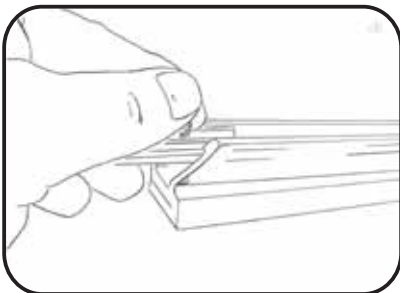

Slide aluminium plate into K9 track.

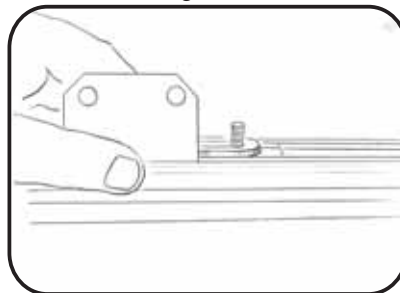

Place bottom foot on K9 track.

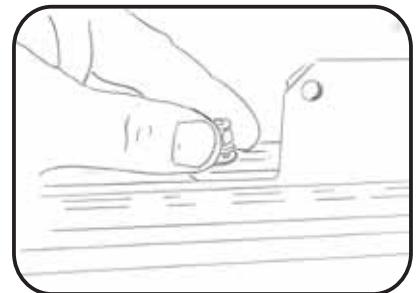

Thread nylock nuts onto thread.

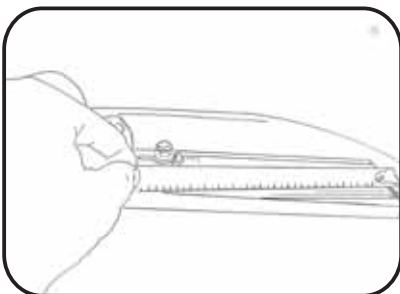

Measure between the legs to align with roof rack load bars.

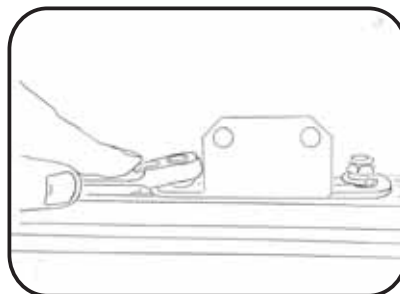

Tighten bottom foot with 13mm spanner/wrench.

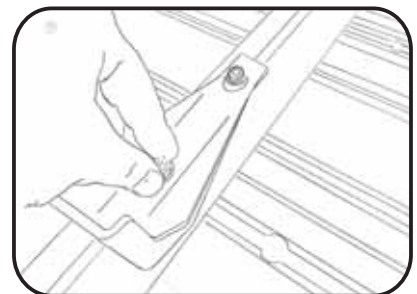

Refer to Section 2 in order to mount rack.



JOB WELL DONE!

Mounting K9 rails onto double cabs and vehicles without OEM hole insert provided.

GETTING STARTED:

- Socket set
- Flat screwdriver
- Star screwdriver
- 6.5mm drill bit
- Small tube of silicone
- Measuring tape
- 4mm allen key
- Marking pen

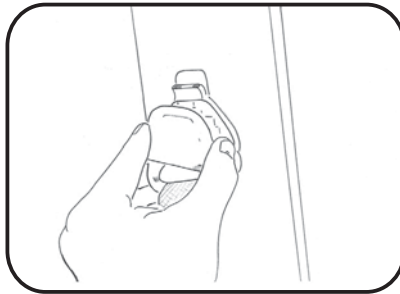

Unclip plastic cover on seatbelt slide.

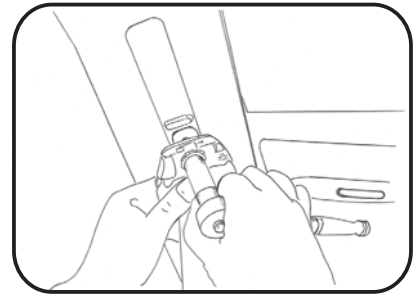

Remove with socket set.

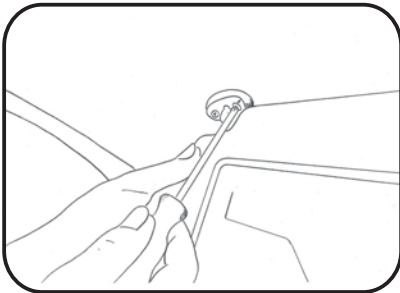

Undo sunvisors with star screwdriver.

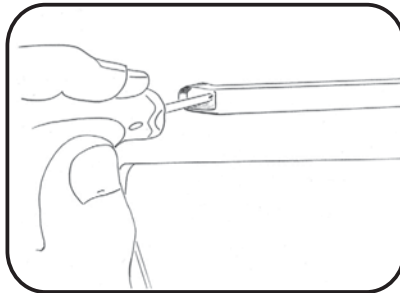

Undo side handles.

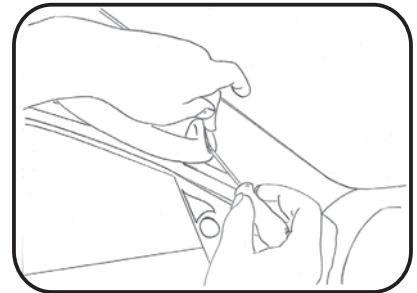

After all handles have been removed unclip plastic cover strips in order to drop hood lining.

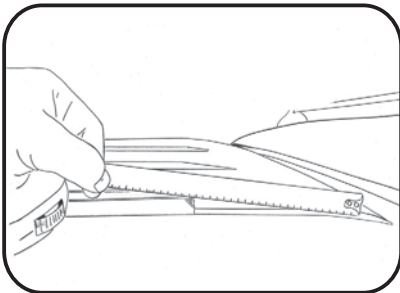

Place K9 rails on roof and use a measuring tape to make sure that they are equal on both sides.

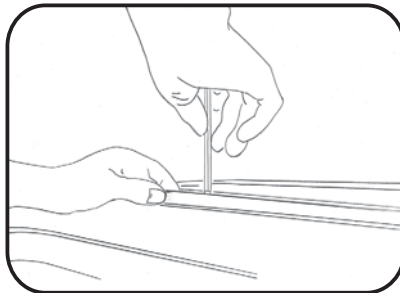

Mark holes with marking pen.

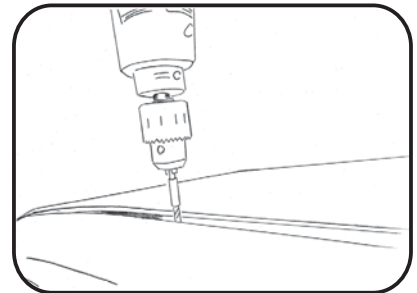

Place tape around drill bit in order to stop drill bit going too deep. Make sure when drilling that you do not drill into airbag actuator.

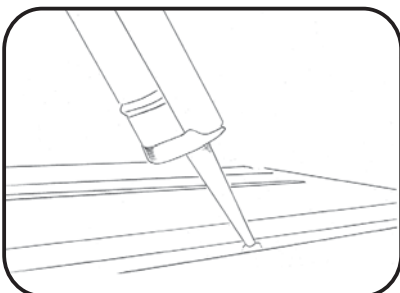

Vacuum holes and silicone.

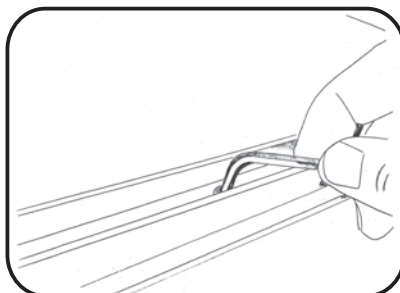

Systematically tighten bolts with 4mm allen key.

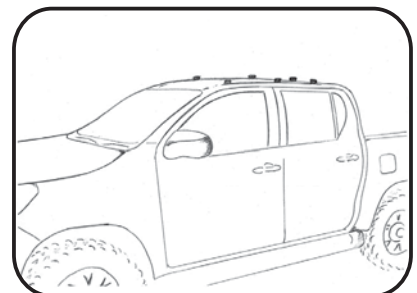

JOB WELL DONE! With regards to mounting the rack, refer to section 2.

Mounting K9 rails onto new shape Fortuner.

GETTING STARTED:

Socket set
 Small flat screw driver
 Star screw driver
 Measuring tape
 4mm allen key
 Marking pen
 Plastic clip remover
 2 x90 degree scribes
 Small tube of silicone



Unclip plastic cover on seatbelt slide.

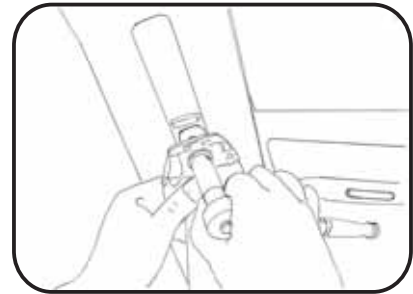

Remove with socket set.

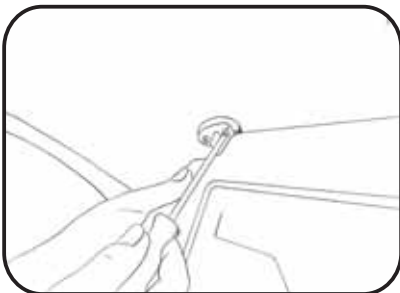

Undo sunviser with star screwdriver.



Pry plastic cover open with small flat screwdriver to gain access to bolts in handles.

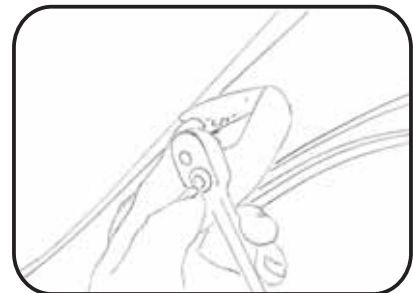

Remove handles with ratchet set.

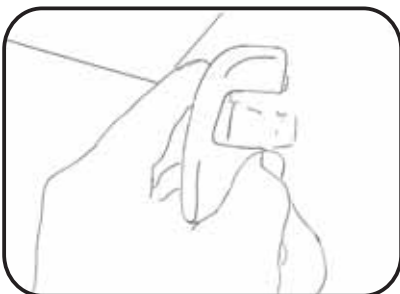

Unclip plastic cover on seatbelt at the back of vehicle.

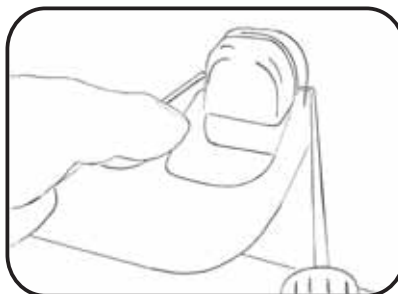

In order to remove grab handles slot 90 degree scribe in holes of each plastic clip and pull downwards.

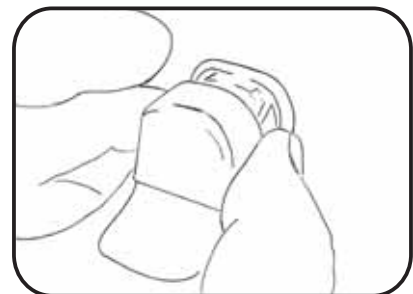

Take hold of plastic clips, remove plastic clip completely by pulling downwards.

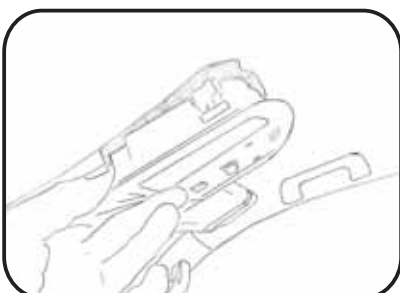

In order to remove front roof light gently take hold of light and pull downwards in order to unclip.



Centre and rear lights has release clips in the corners.



Gently pry plastic panels away from bodywork.

Mounting K9 rails onto new shape Fortuner.

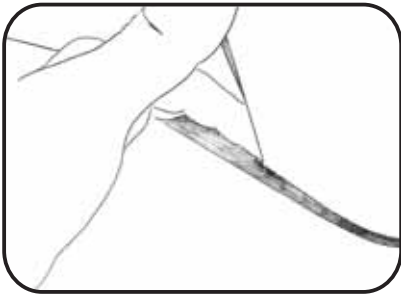

Gently pry plastic panels away from the body work at the back.

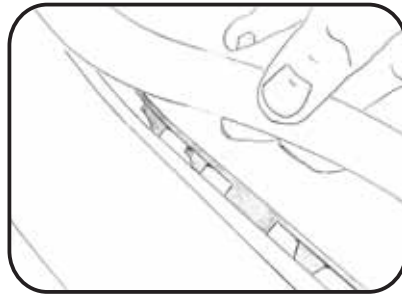

Remove door rubber from all side doors and rear door.

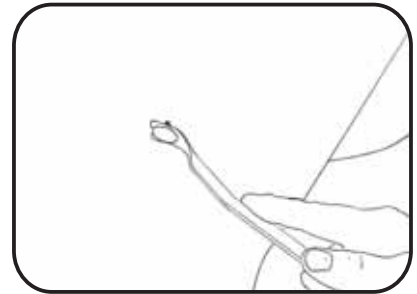

Use plastic clip remover to remove clips in roof lining.

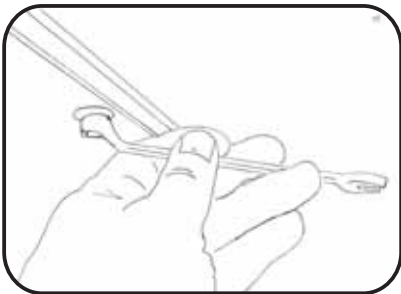

Undo nuts on the inside of the vehicle to loosen OEM bars.

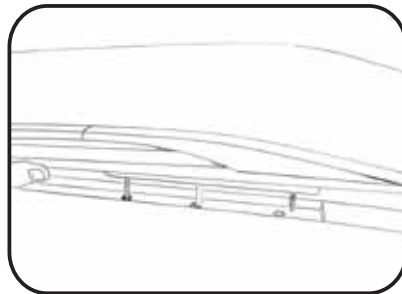

Pull up on OEM bars and remove.

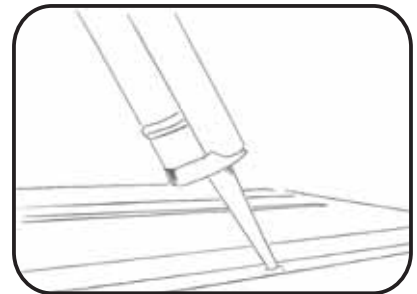

Apply a generous amount of silicone around the holes.

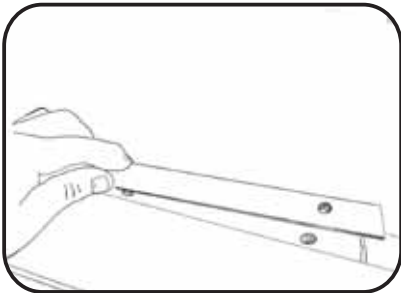

Place flat bar in groove of vehicle with rubber facing down.

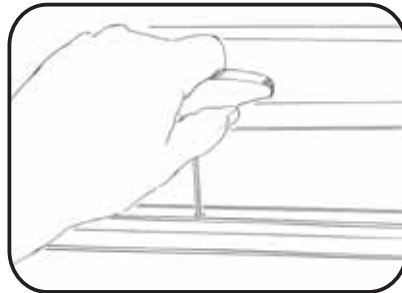

Fasten K9 rails down with bolts provided.

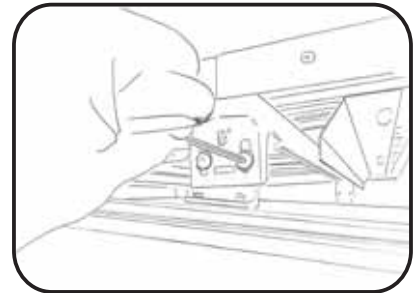

Fit roof rack rails as per Section 2.

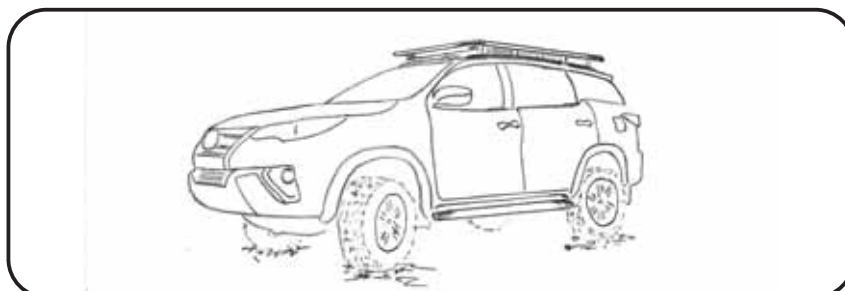

JOB WELL DONE!

Mounting K9 Spine system

GETTING STARTED:

13mm Spanner/Wrench
 Measuring Tape
 4mm Allen key
 Pencil
 Small tube of silicone
 Drill
 5mm drill bit+ stop
 Vacuum cleaner
 Pop Rivet Gun
 Sharp Knife

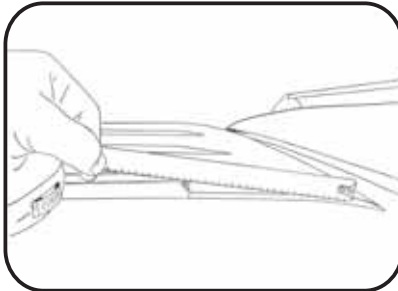

Measure both sides with a tape measure. Rule of thumb is 50mm from mark on rubber strip.

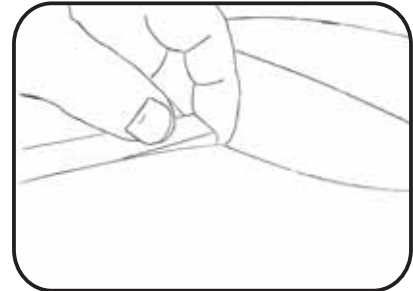

Pry rubber strip out of groove in the front.

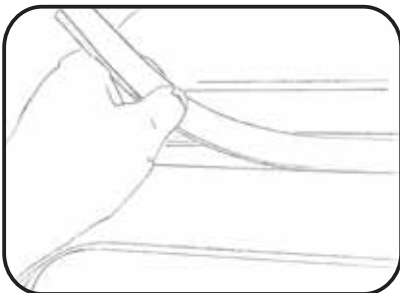

Fold rubber strip out of the way.

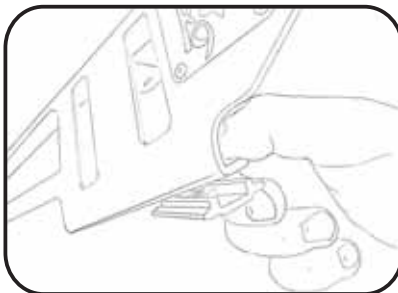

Attach track slide to K9 spine.

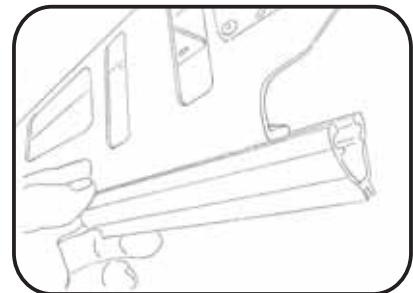

Slide aluminium track onto slides.

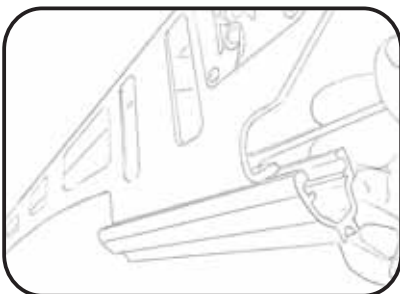

Centre aluminium slide and fasten in place.

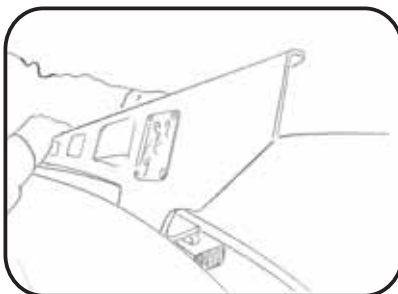

Place K9 spine in place in groove on vehicle align with marks already made.

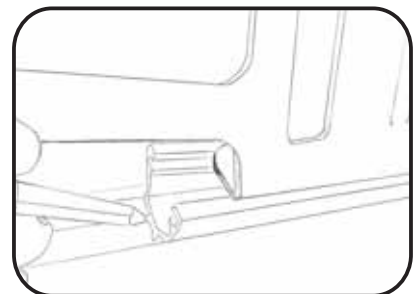

Mark with pencil on each slide of the aluminium slides.

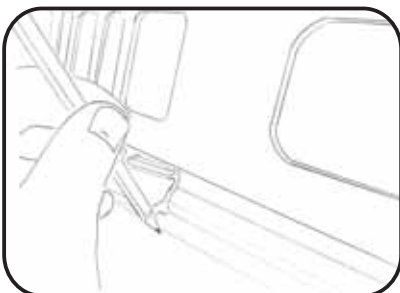

Do the same at the back.

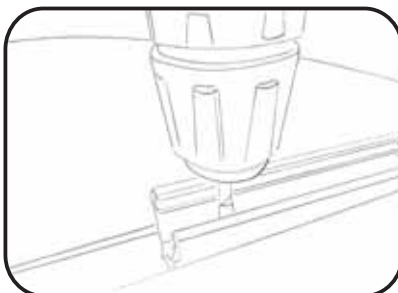

Remove aluminium slide from K9 spine place in groove and align with pencil marks and drill with 5mm drill +stop



Remove aluminium track and vacuum groove.

Mounting K9 Spine system

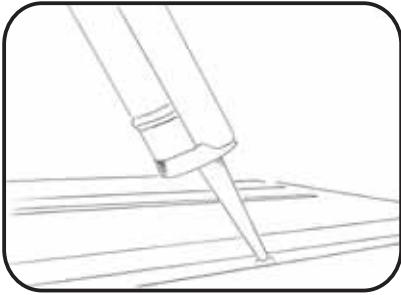

Silicone around the holes.

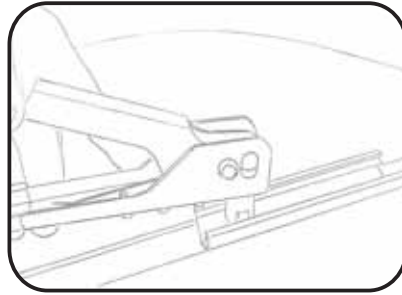

Pop Rivet the track in place with rivets supplied.

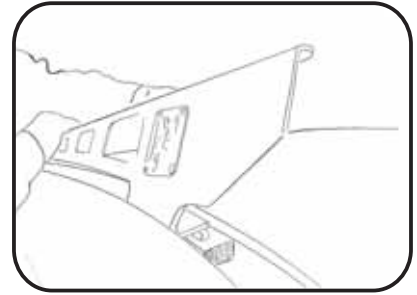

Slide aluminium slides into track and place K9 spine in place.

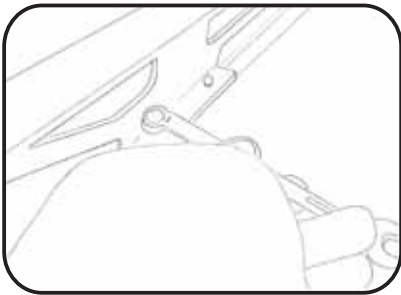

Thread nylock nuts onto thread and tighten with 13mm spanner wrench.

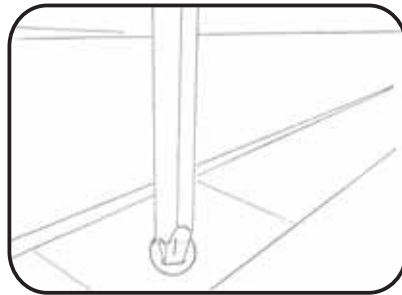

If the vehicle already has threads in the roof, take a sharp object eg. pencil or pen and pierce a hole through clear tape to gain access to threads



Silicone holes in roof.

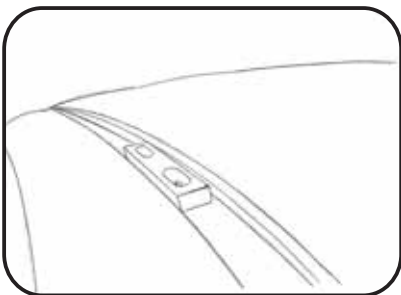

Place spacer in groove of vehicle.

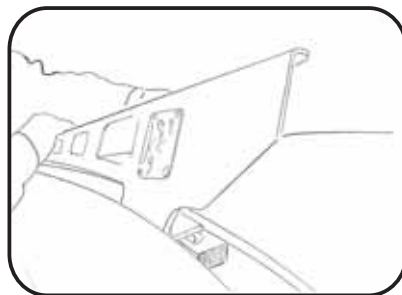

Place K9 spine on top of spacer.

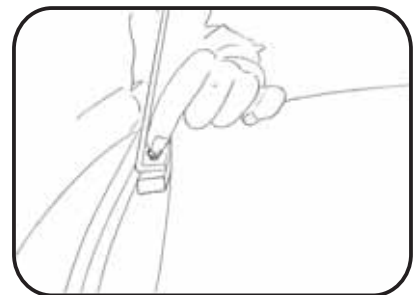

Secure with bolts provided.

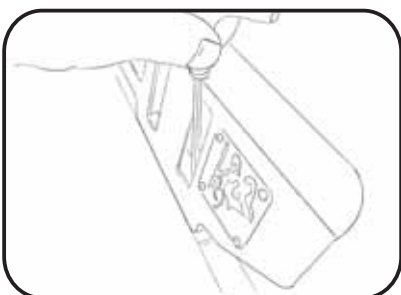

Tighten with 4mm allen key.

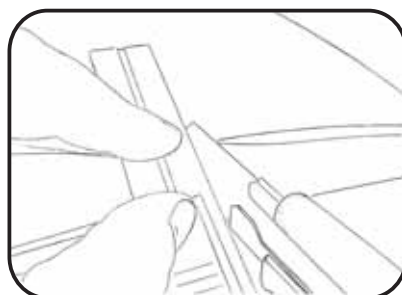

Use a straight edge to mark and cut rubber strip.

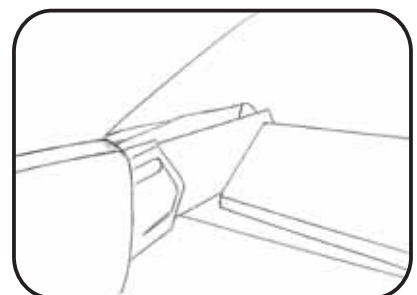

Cut with a sharp knife.

Mounting K9 Spine system

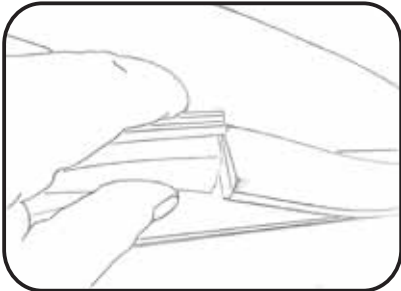

Twist rubber once cut in order to break metal insert.

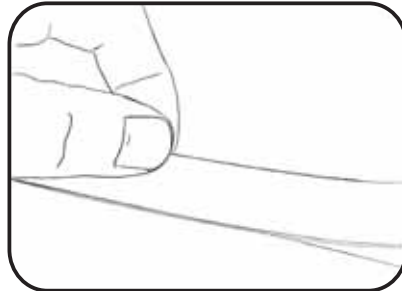

Press rubber strip back in groove.

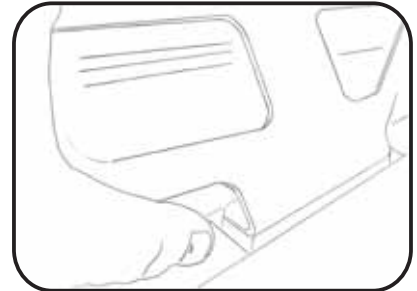

The rubber strip should be cut so as it fits exactly up against spacer or aluminium track.

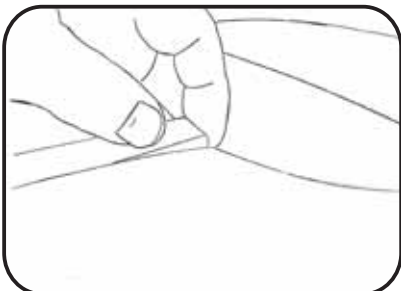

Press down on rubber strip in the front so as it clips into place.



Slide bolts provided into roof rack.



Walk K9 rack over vehicle.

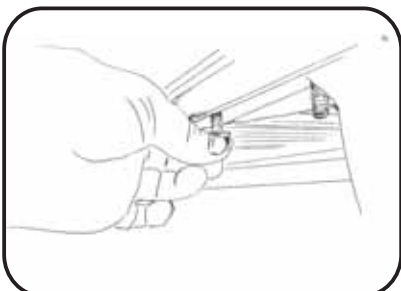

Align with slots in K9 spine.

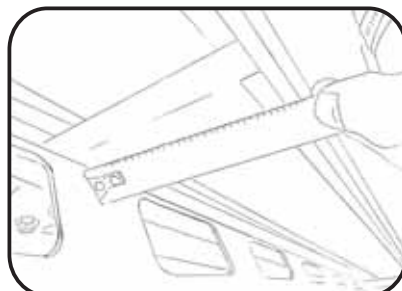

Measure each side to make sure it is in the middle of the vehicle with a measuring tape.

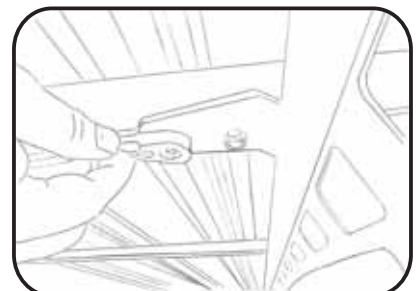

Secure with 13mm spanner wrench,

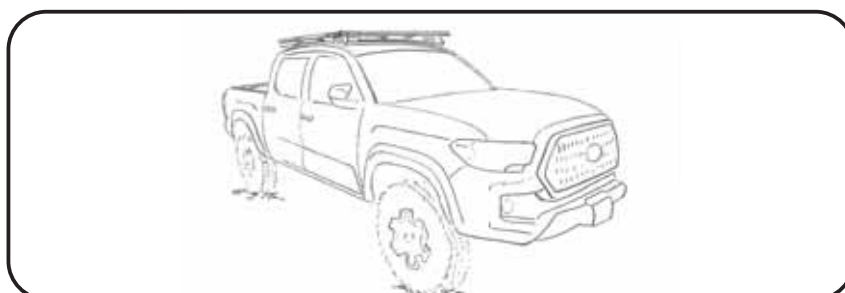

JOB WELL DONE!

K9 ACCESSORIES

All of these accessories mount to the K9 Rack system in minutes. There is no drilling required.

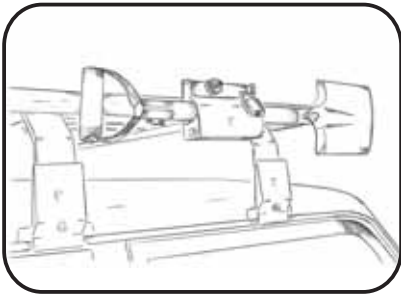

SPADE / SHOVEL AXE KITS.

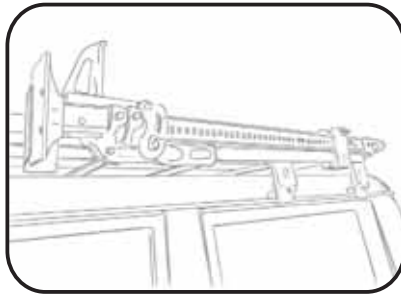

JACK KITS.

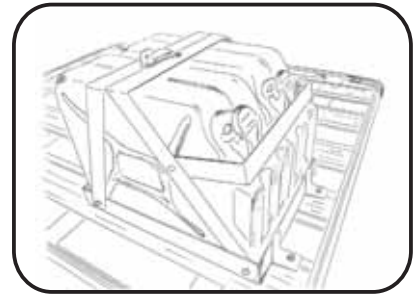

SINGLE, DOUBLE JERRY CAN HOLDER.

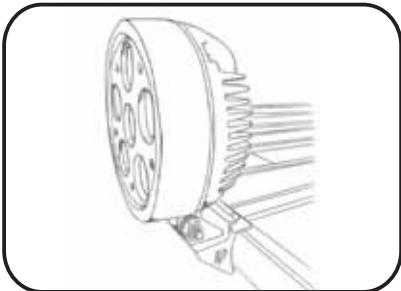

SPOTLIGHT AND LIGHTBAR KIT.

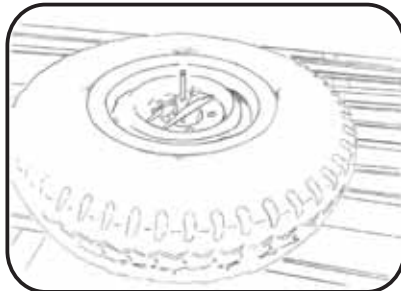

SPARE WHEEL KIT.

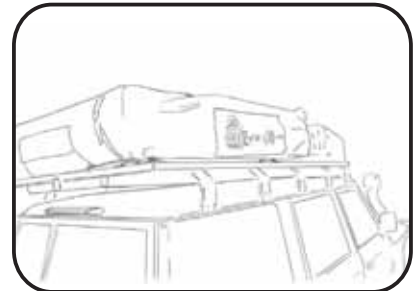

ROOFTENT FITTING KITS.

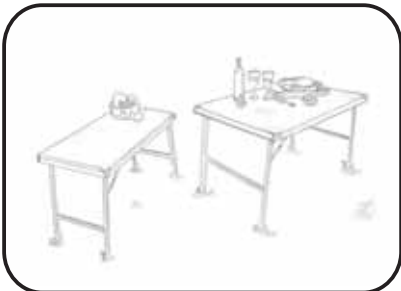

SMALL, MEDIUM, LARGE AND XL TABLES AND UNDER RACK SLIDES.

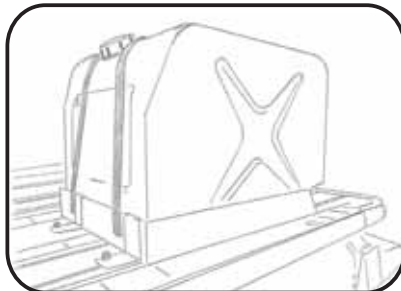

WATER CAN HOLDER.

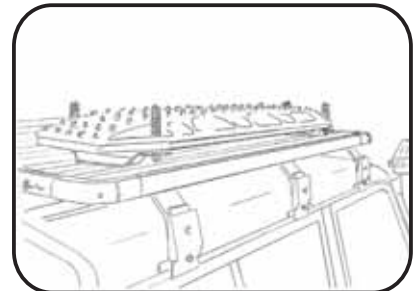

MAX TRAX BRACKET.

K9 LADDERS



76/78 CRUISER LADDERS



DEFENDER LADDER AND STEP



DISO 3/4 LADDER

Should there be an accessory that is not listed above that you would like, please contact your nearest K9 distributor, as chances are we do manufacture it.

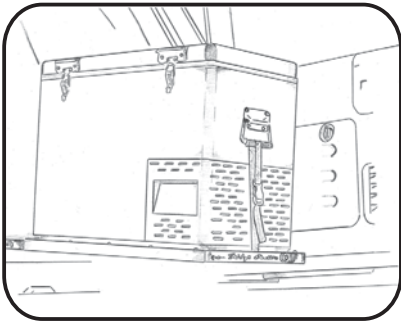

FRIDGE SLIDES



Manufactures a large range of Rec Vee equipment. For more information please contact your nearest distributor or go to www.eeziawn.com

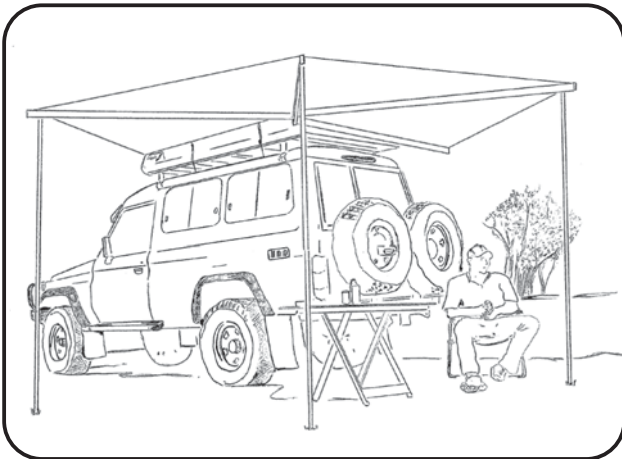

BAT270 AND MANTA 270+

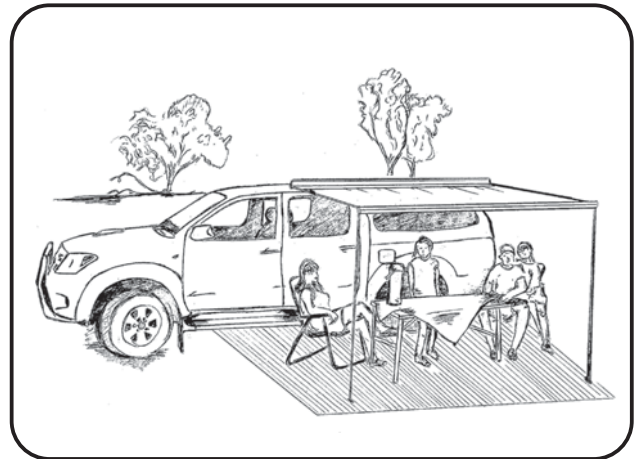

RETRACTABLE AWNINGS

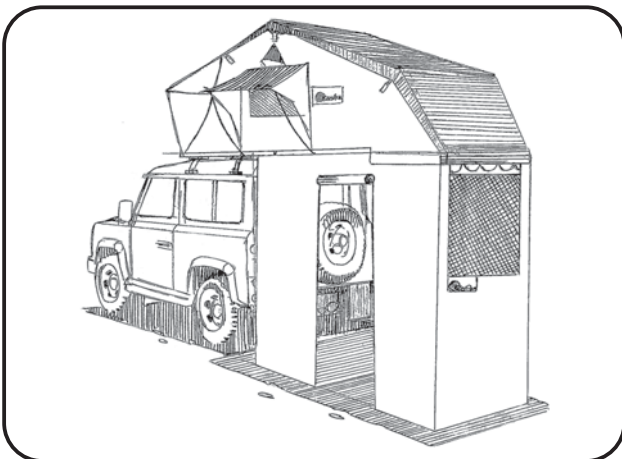

ROOF TENTS

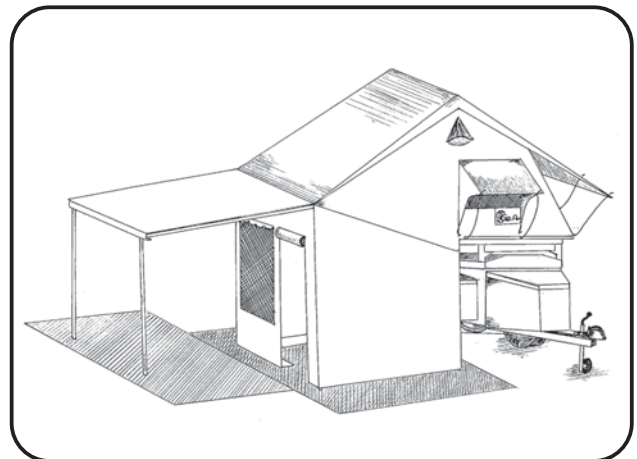

TRAILER TENTS

Eezi-Awn reserves the right to modify their equipment at their own discretion