



Item type
Dining Table

Item name
Atelier

Item no
113765

Attention! Place the item on a soft material on the floor before starting with the assembly, to prevent the item from being damaged.

Care instructions:

Dust regularly and clean with a soft dry cloth. Remove spills immediately as moisture can cause the veneer to peel off the surface.

Eichholtz B.V.
Delfweg 52
2211 VN Noordwijkerhout
The Netherlands

🏠 www.eichholtz.com
✉ service@eichholtz.com
☎ +31 (0)252 515 850

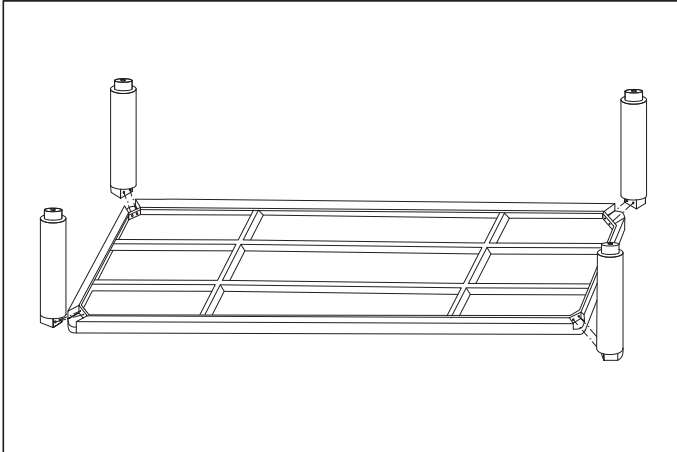

1. Put the dining table top upside down on a padded area.

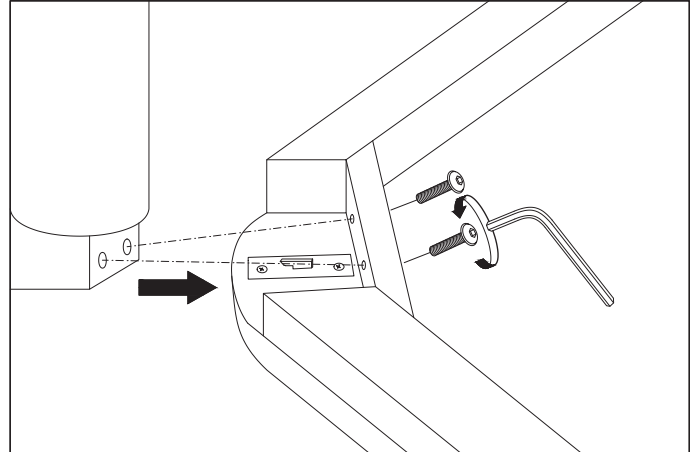

2. Place the legs in the correct position, aligning the holes of the legs with the holes of the top. Fix them with the bolts by using the provided allen key.