



E I C H H O L T Z

112381 CEILING LAMP BERNARDI

ASSEMBLY INSTRUCTION

1

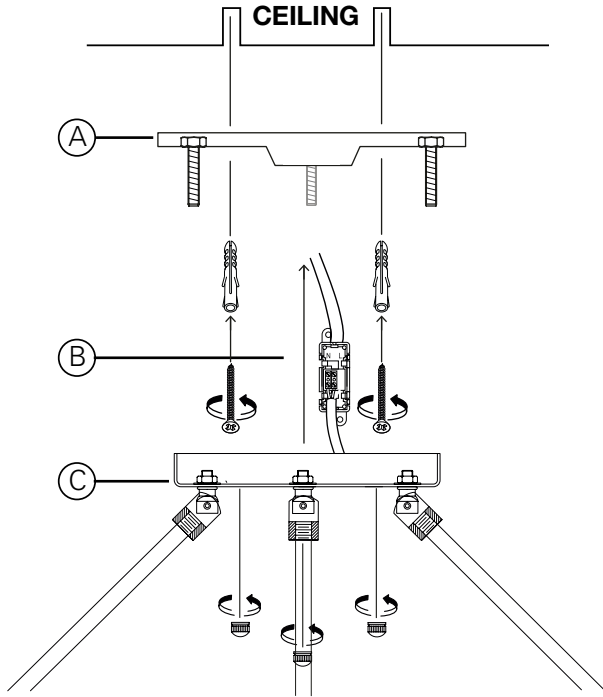

ZOOM

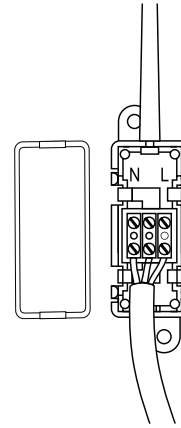

Two people are required for safe mounting of this luminaire.

Turn off the electricity supply at the main circuit panel before installing. Do not connect the electricity supply until your luminaire is fully assembled and installed.

Remove all parts from the carton and connect the pipes to the lamp first. Connect the other end of the pipes to the ceiling canopy (C).

Fix the ceiling plate (A) to the ceiling by using mounting plugs and screws suitable to your ceiling type. Make sure to guide your wires through the middle of the plate.

Place or hold the lamp in an elevated position in such a way that the wires can freely reach the ceiling junction box. Connect the 3 power wires according to their colours (B). Brown is the live wire, blue is the neutral wire, green/yellow is the earth wire.

Place the ceiling canopy (C) flush against the ceiling and fix it securely with the 3 nuts supplied. Tighten the nuts with tools, not just by hand (C).

Place the bulbs and finally unpack the glass decorations (F) and place them into the frame.

CARE INSTRUCTION

Wipe clean with soft, dry cloth. Always avoid the use of harsh chemicals or abrasive cleaners as they may cause damage to the fixture's finish.

