

Item type

Chandelier

Item name

Pasadena

Item no

111593UL

Attention! Do not connect your luminaire to electricity until it is fully assembled.

Care instructions:

Wipe with a soft dry cloth, do not use chemicals or abrasive cleaning materials.

Eichholtz B.V.

Delfweg 52
2211 VN Noordwijkerhout
The Netherlands

🏠 www.eichholtz.com
✉ service@eichholtz.com
☎ +31 (0)252 515 850

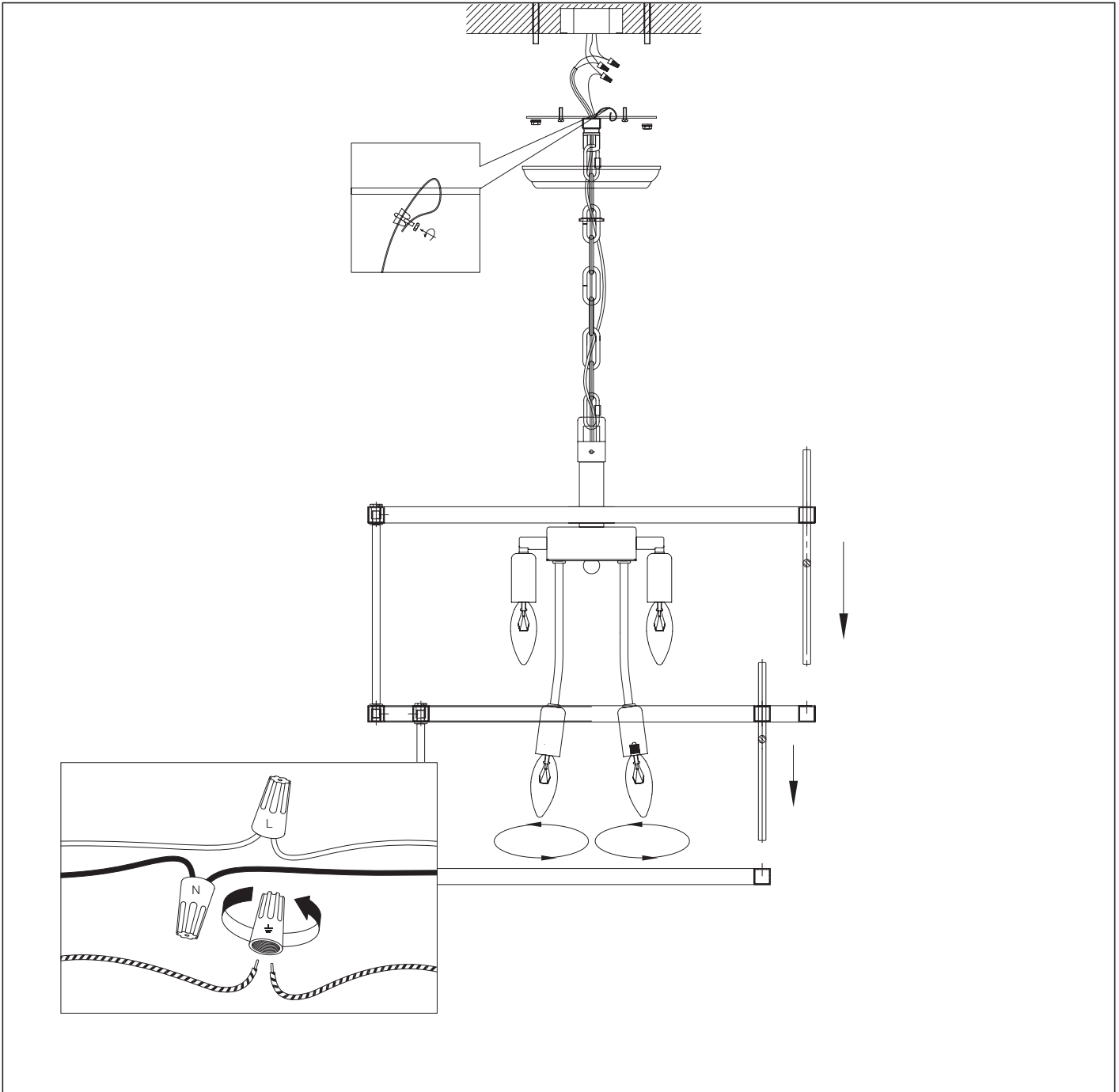

1. Fix the ceiling plate to the ceiling by using mounting plugs and screws suitable for your ceiling.
2. Lock the steel wire to the ceiling plate.
3. Hold the lamp in an elevated position in such a way that the wires can freely reach the ceiling junction box.
Thread the wires through the components: suspension eye, retaining nut, ceiling canopy and connect the 3 wires. L is the live wire, N is the neutral wire. The course wire is the grounding wire.
4. Fix the canopy by screwing the suspension eye (with retaining nut attached) to the ceiling bracket and fix it securely by tightening the retaining nut.
5. Check whether the connection is sufficiently strong by manually loading the chain. Carefully lower the lamp until the chain is taut. Straighten the chain links
6. Place the bulbs.
7. Place the glass.