

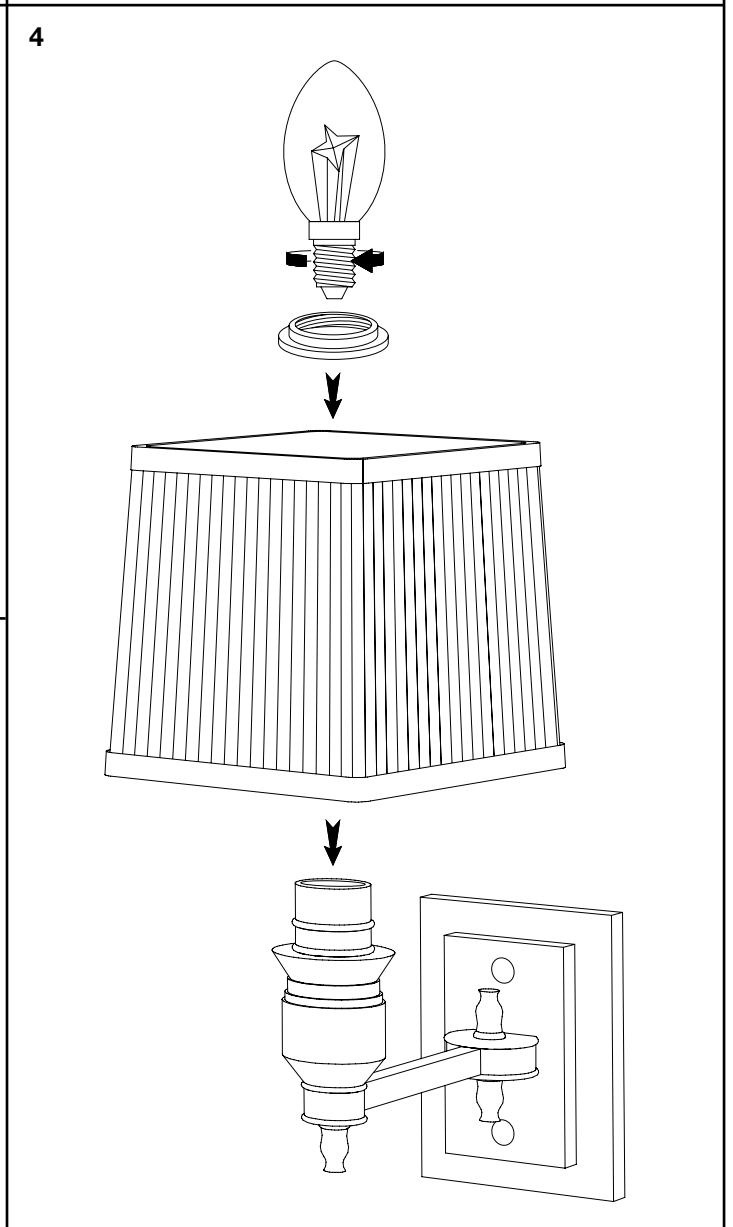

E I C H H O L T Z

108934 WALL LAMP LEXINGTON SINGLE

ASSEMBLY INSTRUCTION

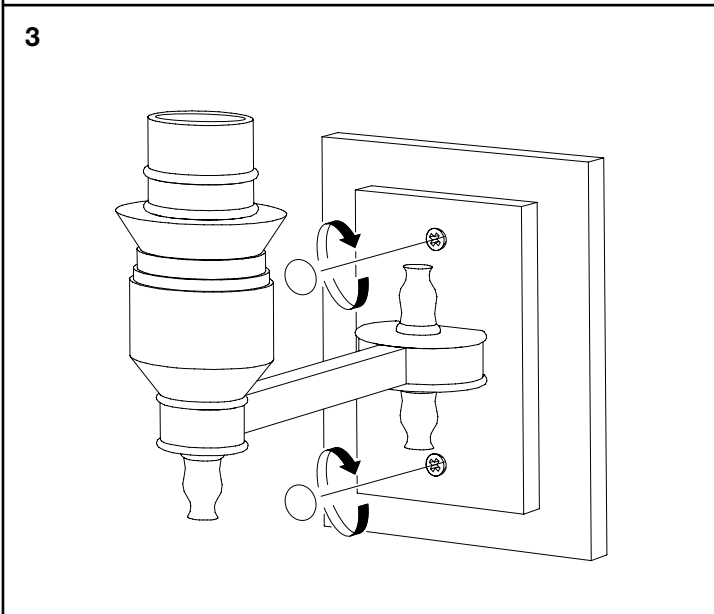
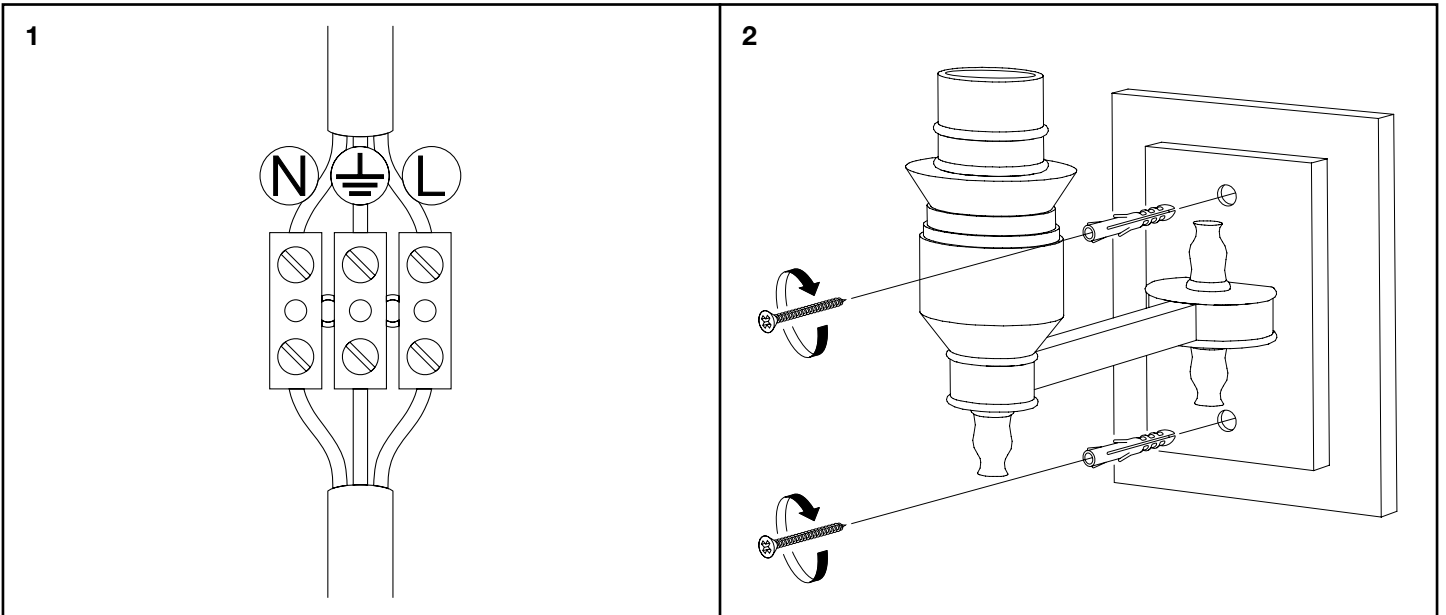

Turn off the electricity supply at the main circuit panel before installing.
Do not connect the electricity supply until your luminaire is fully assembled and installed.

Connect the 3 wires according to their colours. Brown is the live wire, blue is the neutral wire, green/yellow is the earth wire.

Fix the luminaire to your junction box or wall by using suitable wall mounting plugs and screws.

Screw the covers on the screw heads.