

FW
r1.00

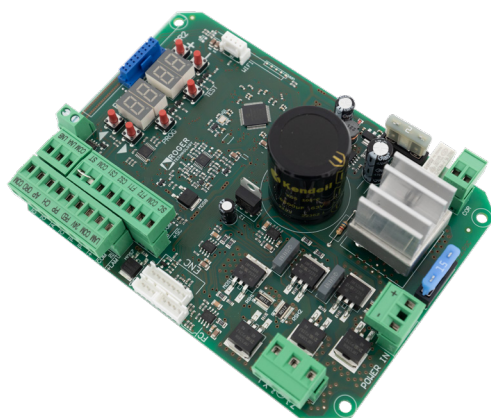

IS271 Rev.00 22/09/2023

B70/1T

centrale di comando 24Vdc per cancelli scorrevoli su colonna

ROGER
BRUSHLESS

Istruzioni originali



- IT - Istruzioni ed avvertenze per l'installatore
- EN - Instructions and warnings for the installer
- DE - Anweisungen und Hinweise für den Installateur
- FR - Instructions et consignes pour l'installateur
- ES - Instrucciones y advertencias para el instalador
- PT - Instruções e advertências para o instalador
- NL - Aanwijzingen en waarschuwingen voor de installateur
- PL - Instrukcja i ostrzeżenia dla instalatora

ROGER
TECHNOLOGY

FW
r1.00

Dispositivo IP B74/BCONNECT
B74/BCONNECT IP device

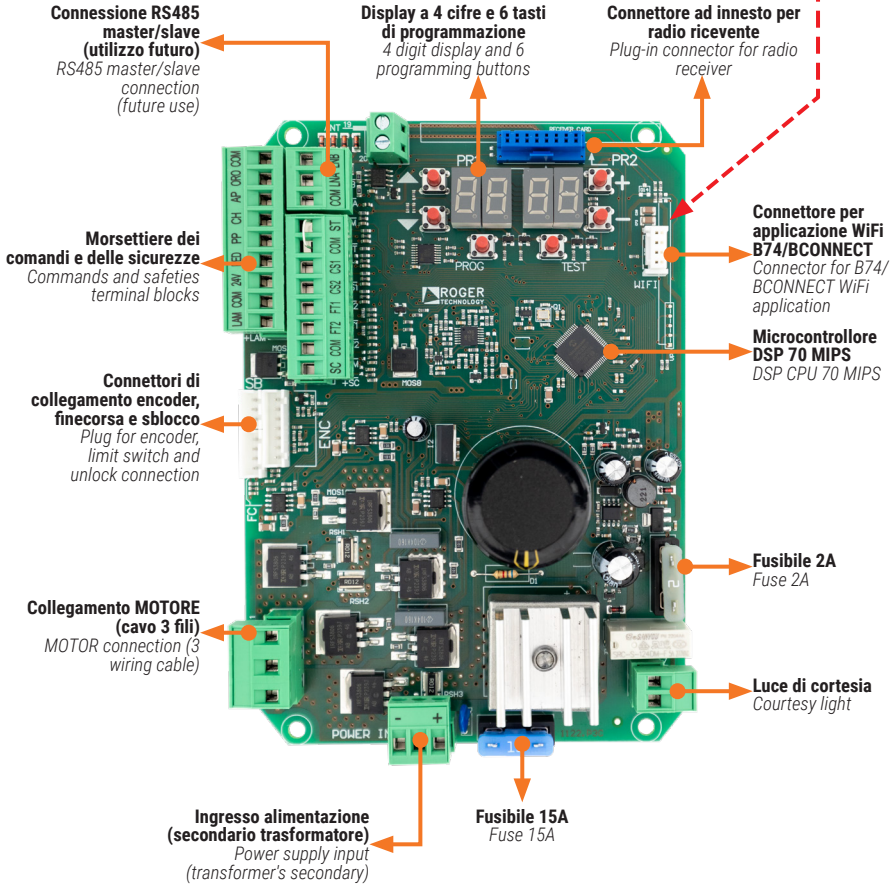

1

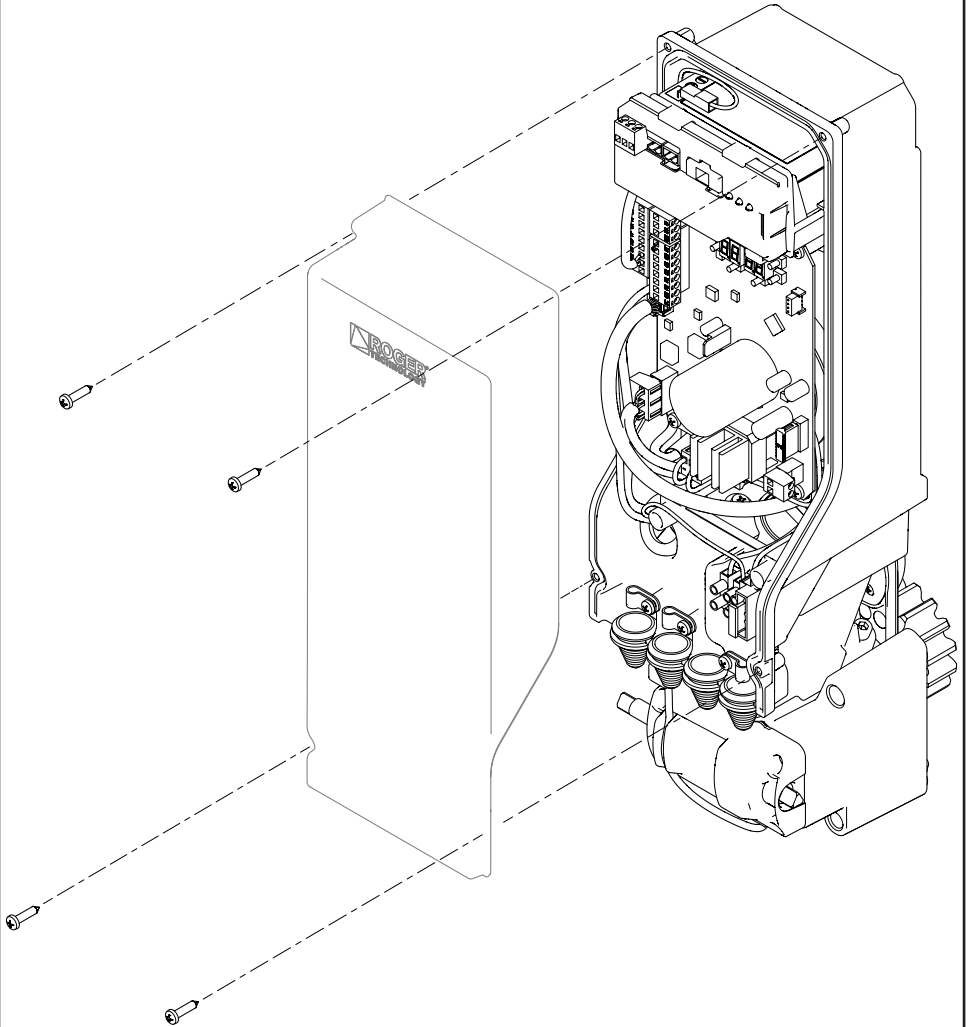

Scheda carica batteria **B71/BC** - **B71/BC** battery charger

2

dal secondario del trasformatore
from the secondary of the transformer

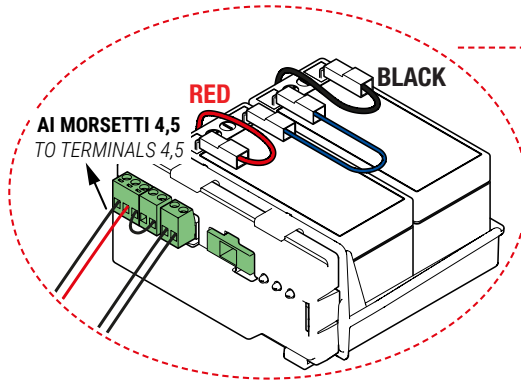

2 x 12V 1,2Ah

⚠ AGM Battery ONLY

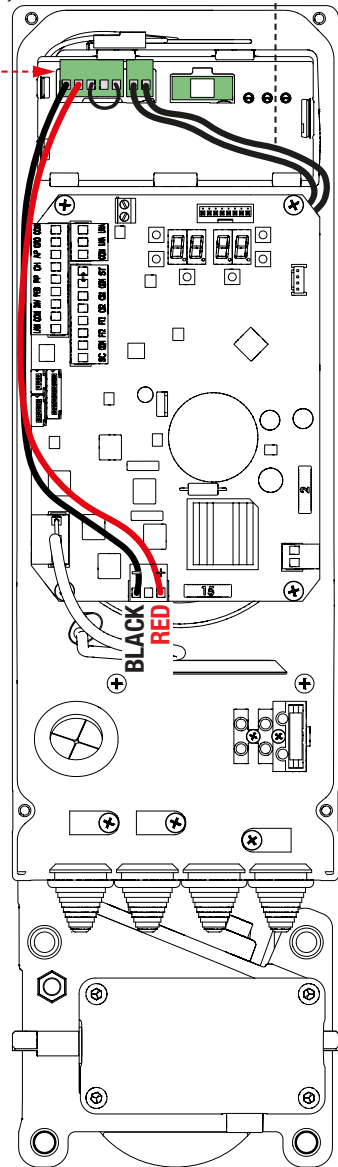

3

ANTENNA

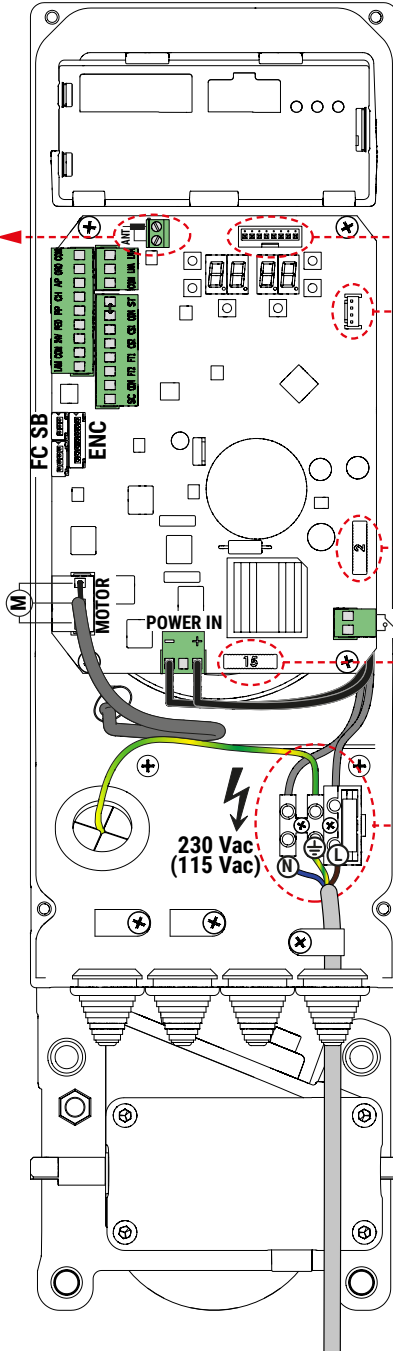

H93/RX22A/I
RICEVITORE RADIO
RADIO RECEIVER

B74/BCONNECT

F2 FUSIBILE
FUSE 2A

F1 FUSIBILE
FUSE 15A

F3 FUSIBILE
FUSE T1A
(T2A @115Vac)

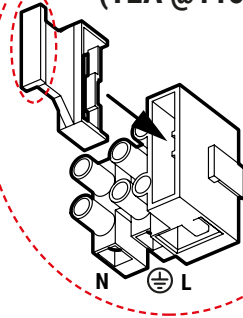

TW90 High Speed



4

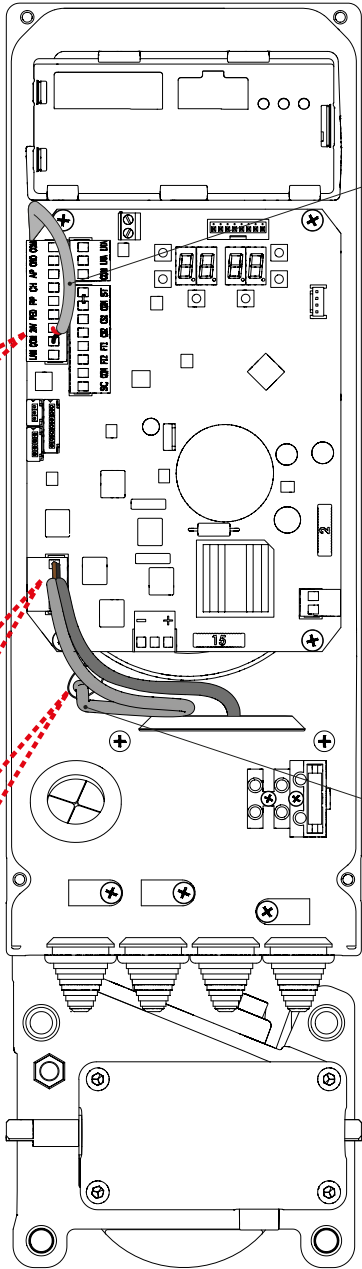
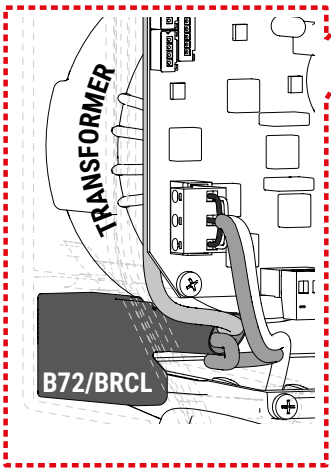
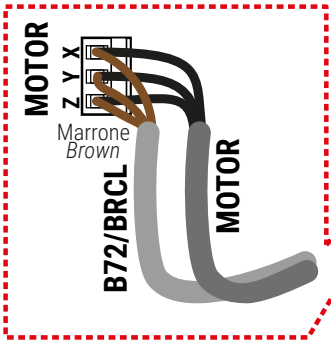
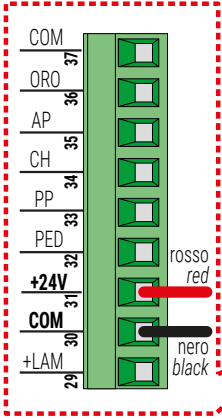

B72/BRCL

B72/BRCL



5

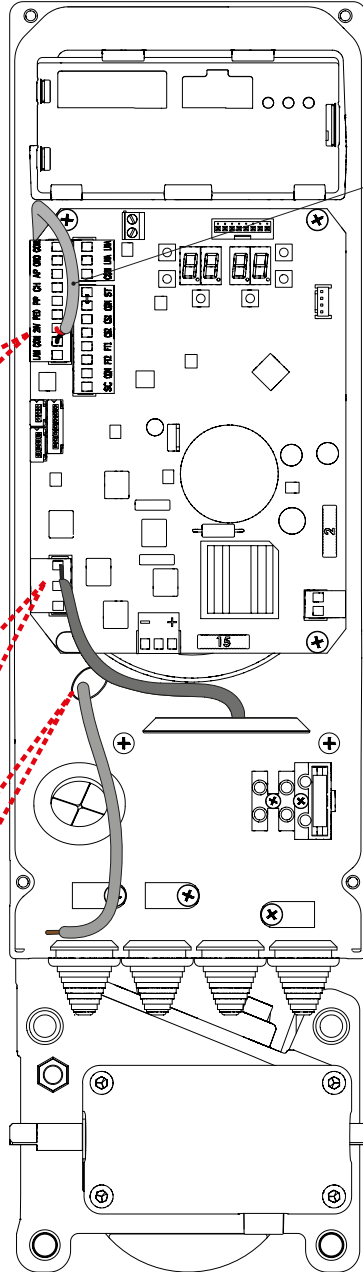
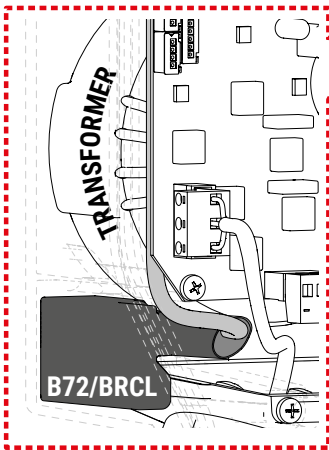
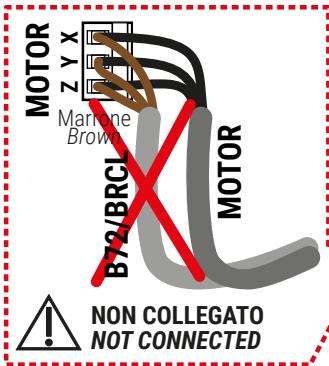
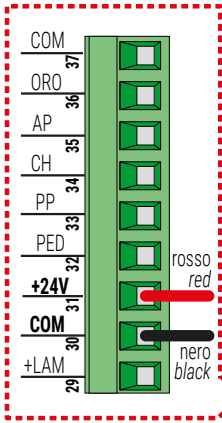

6

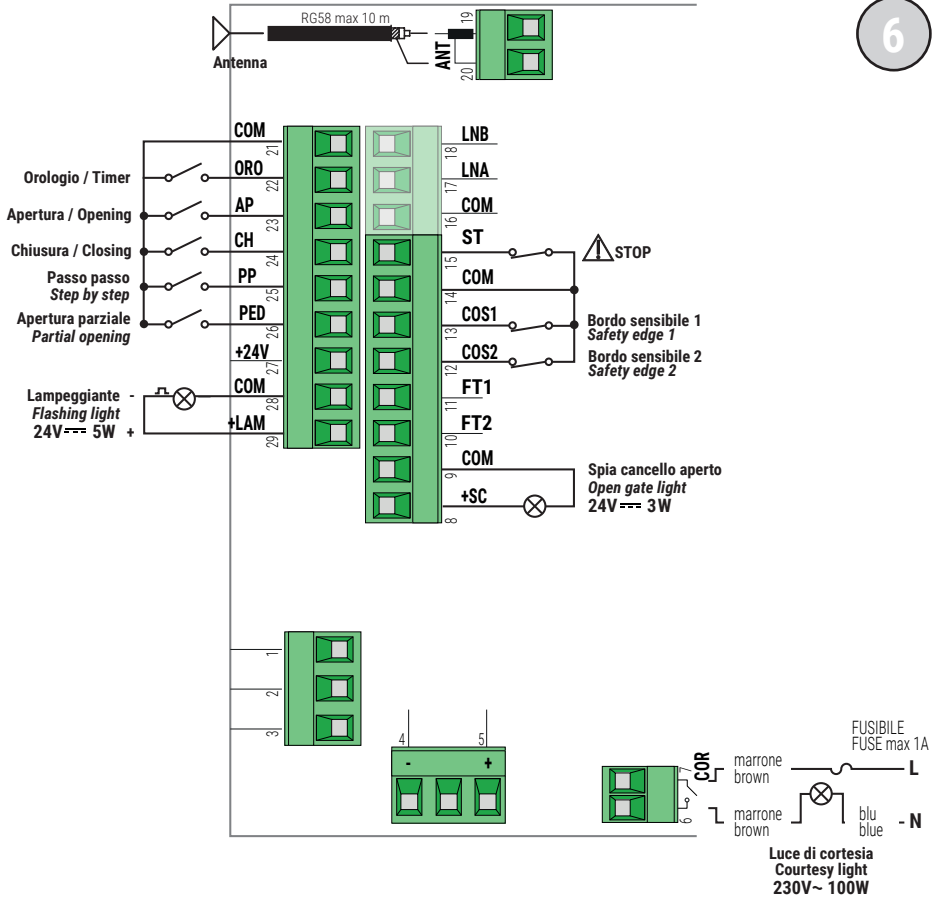

7



Utilizzo alternativo dell'uscita SC (par.20 diverso da 00).
Alternative use of SC output (par.20 different from 00).

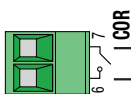

SISTEMA DI
GESTIONE
MANAGEMENT
SYSTEM



COLLEGAMENTO CON 1 COPPIA FOTOCELLULE SINCRONIZZATE (MODALITÀ NORMALE, SOLO COPPIA MASTER)
CONNECTION WITH 1 SYNCHRONISED PHOTOCELL PAIR (NORMAL MODE, MASTER PAIR ONLY)

ROSSO = libero da jumper
 RED = jumper free

8

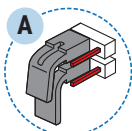
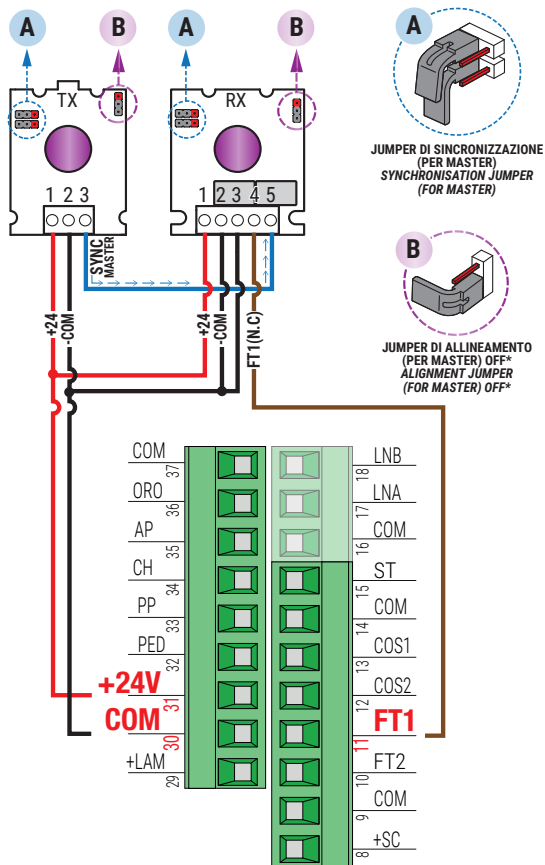

JUMPER DI SINCRONIZZAZIONE (PER MASTER)
SYNCHRONISATION JUMPER (FOR MASTER)

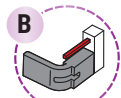

JUMPER DI ALLINEAMENTO (PER MASTER) OFF*
ALIGNMENT JUMPER (FOR MASTER) OFF*

* Per eseguire la modalità in di allineamento ottico
 (NOTA: consultare le istruzioni delle fotocellule):
 * To perform optical alignment mode
 (NOTE: refer to photocell instructions):

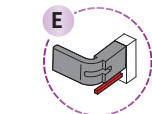
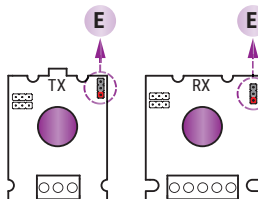

JUMPER DI ALLINEAMENTO ON*
ALIGNMENT JUMPER ON*



ATTENZIONE! Modificare la posizione dei jumper di sincronizzazione o di allineamento solamente quando le fotocellule sono **NON ALIMENTATE!** La configurazione scelta con i jumper viene memorizzata dalle fotocellule solamente all'accensione delle fotocellule.

Scollegare la morsetteria della centrale che fornisce alimentazione alle fotocellule, oppure togliere completamente la tensione al controller digitale (scollegando, se presenti, anche le batterie di backup) e verificare nella fotocellula TX / RX che il LED rosso di alimentazione sia spento; procedere soltanto ora all'impostazione della configurazione dei jumper.

ATTENTION! Please ensure that the photocell jumpers are only changed with the power to the control panel switched off, including the disconnection of any battery backup. Remove the terminal of the photocell inputs or completely remove the voltage from the digital controller (check that the digital controller is not powered by backup batteries) and check that the TX / RX photocell red power LED is off.

SI RACCOMANDA L' USO DI fotocellule Serie F4ES - F4S / RECOMMENDED USE for Series F4ES - F4S photocells

COLLEGAMENTO CON 2 COPPIE FOTOCELLE SINCRONIZZATE (MODALITÀ NORMALE, 1 MASTER E 1 SLAVE)
CONNECTION WITH 2 SYNCHRONISED PHOTOCCELL PAIRS (NORMAL MODE, 1 MASTER AND 1 SLAVE)

ROSSO = libero da jumper
 RED = jumper free

9

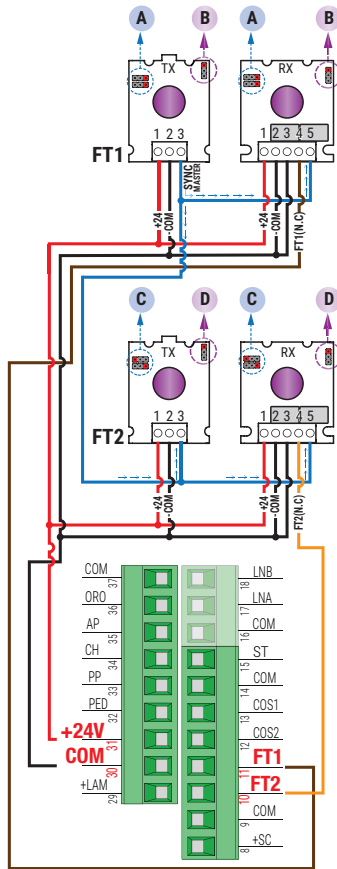

JUMPER DI SINCRONIZZAZIONE (PER MASTER)
SYNCHRONISATION JUMPER (FOR MASTER)



JUMPER DI ALLINEAMENTO (PER MASTER) OFF*
ALIGNMENT JUMPER (FOR MASTER) OFF*



JUMPER DI SINCRONIZZAZIONE (PER SLAVE1)
SYNCHRONISATION JUMPER (FOR SLAVE1)



JUMPER DI ALLINEAMENTO (PER SLAVE1) OFF*
ALIGNMENT JUMPER (FOR SLAVE1) OFF*

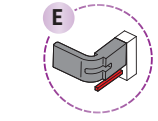
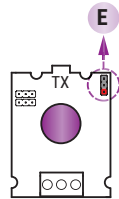

JUMPER DI ALLINEAMENTO ON*
ALIGNMENT JUMPER ON*

* Per eseguire la modalità in di allineamento ottico
 (NOTA: consultare le istruzioni delle fotocelle):
 * To perform optical alignment mode
 (NOTE: refer to photocell instructions):



ATTENZIONE! Modificare la posizione dei jumper di sincronizzazione o di allineamento solamente quando le fotocelle sono **NON ALIMENTATE!** La configurazione scelta con i jumper viene memorizzata dalle fotocelle solamente all'accensione delle fotocelle.

Scollegare la morsetteria della centrale che fornisce alimentazione alle fotocelle, oppure togliere completamente la tensione al controller digitale (scollegando, se presenti, anche le batterie di backup) e verificare nella fotocella TX / RX che il LED rosso di alimentazione sia spento; procedere soltanto ora all'impostazione della configurazione dei jumper.

ATTENTION! Please ensure that the photocell jumpers are only changed with the power to the control panel switched off, including the disconnection of any battery backup. Remove the terminal of the photocell inputs or completely remove the voltage from the digital controller (check that the digital controller is not powered by backup batteries) and check that the TX / RX photocell red power LED is off.

SI RACCOMANDA L' USO DI fotocelle Serie F4ES - F4S / RECOMMENDED USE for Series F4ES - F4S photocells

TEST FOTOCELLE · PHOTOCELLS TEST (AB 02)

COLLEGAMENTO CON 1 COPPIA FOTOCELLE SINCRONIZZATE (MODALITÀ NORMALE, SOLO COPPIA MASTER) CONNECTION WITH 1 SYNCHRONISED PHOTOCELL PAIR (NORMAL MODE, MASTER PAIR ONLY)

ROSSO = libero da jumper
RED = jumper free

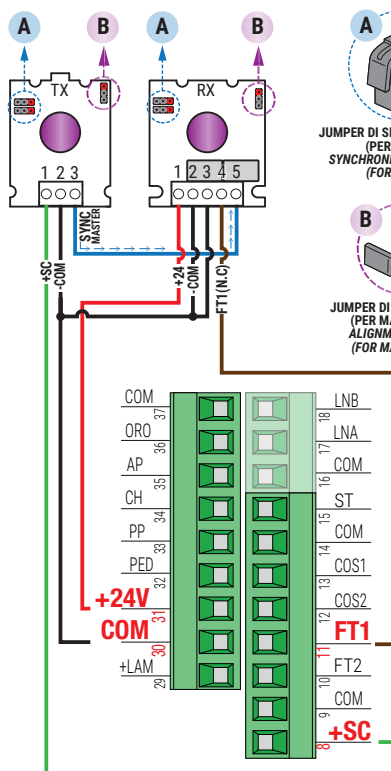

10

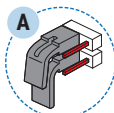

JUMPER DI SINCRONIZZAZIONE (PER MASTER)
SYNCHRONISATION JUMPER (FOR MASTER)

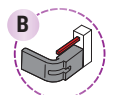

JUMPER DI ALLINEAMENTO (PER MASTER) OFF*
ALIGNMENT JUMPER (FOR MASTER) OFF*

* Per eseguire la modalità in di allineamento ottico
(NOTA: consultare le istruzioni delle fotocelle):
* To perform optical alignment mode
(NOTE: refer to photocell instructions):

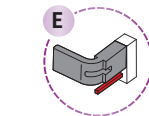
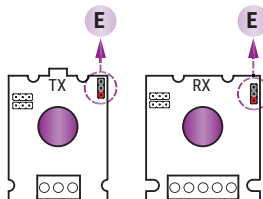

JUMPER DI ALLINEAMENTO ON*
ALIGNMENT JUMPER ON*



ATTENZIONE! Modificare la posizione dei jumper di sincronizzazione o di allineamento solamente quando le fotocelle sono **NON ALIMENTATE!** La configurazione scelta con i jumper viene memorizzata dalle fotocelle solamente all'accensione delle fotocelle.

Scollegare la morsetteria della centrale che fornisce alimentazione alle fotocelle, oppure togliere completamente la tensione al controller digitale (scollegando, se presenti, anche le batterie di backup) e verificare nella fotocella TX / RX che il LED rosso di alimentazione sia spento; procedere soltanto ora all'impostazione della configurazione dei jumper.

ATTENTION! Please ensure that the photocell jumpers are only changed with the power to the control panel switched off, including the disconnection of any battery backup. Remove the terminal of the photocell inputs or completely remove the voltage from the digital controller (check that the digital controller is not powered by backup batteries) and check that the TX / RX photocell red power LED is off.

SI RACCOMANDA L' USO DI fotocelle Serie F4ES - F4S / RECOMMENDED USE for Series F4ES - F4S photocells

TEST FOTOCELLE · PHOTOCELLS TEST (AB 02)

COLLEGAMENTO CON 2 COPPIE FOTOCELLE SINCRONIZZATE (MODALITÀ NORMALE, 1 MASTER E 1 SLAVE) CONNECTION WITH 2 SYNCHRONISED PHOTOCCELL PAIRS (NORMAL MODE, 1 MASTER AND 1 SLAVE)

ROSSO = libero da jumper
RED = jumper free

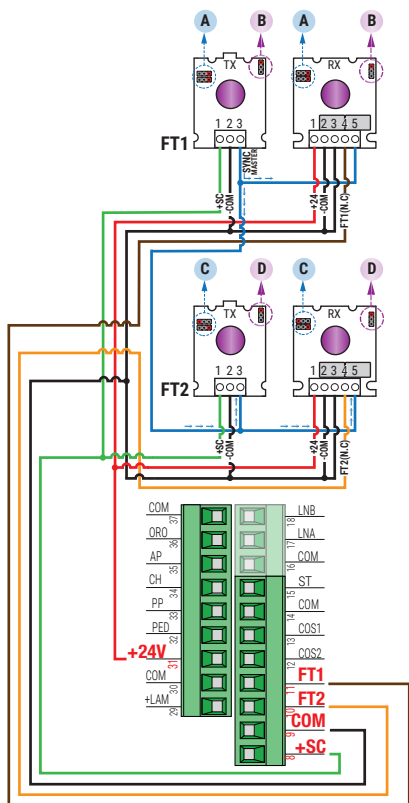

11



JUMPER DI SINCRONIZZAZIONE (PER MASTER)
SYNCHRONISATION JUMPER (FOR MASTER)



JUMPER DI ALLINEAMENTO (PER MASTER) OFF*
ALIGNMENT JUMPER (FOR MASTER) OFF*



JUMPER DI SINCRONIZZAZIONE (PER SLAVE1)
SYNCHRONISATION JUMPER (FOR SLAVE1)



JUMPER DI ALLINEAMENTO (PER SLAVE1) OFF*
ALIGNMENT JUMPER (FOR SLAVE1) OFF*

* Per eseguire la modalità in di allineamento ottico
(NOTA: consultare le istruzioni delle fotocelle):
* To perform optical alignment mode
(NOTE: refer to photocell instructions):

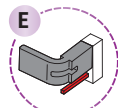
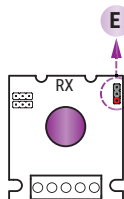
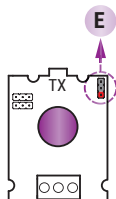

JUMPER DI ALLINEAMENTO ON*
ALIGNMENT JUMPER ON*



ATTENZIONE! Modificare la posizione dei jumper di sincronizzazione o di allineamento solamente quando le fotocelle sono **NON ALIMENTATE!** La configurazione scelta con i jumper viene memorizzata dalle fotocelle solamente all'accensione delle fotocelle.

Scollegare la morsetteria della centrale che fornisce alimentazione alle fotocelle, oppure togliere completamente la tensione al controller digitale (scollegando, se presenti, anche le batterie di backup) e verificare nella fotocella TX / RX che il LED rosso di alimentazione sia spento; procedere soltanto ora all'impostazione della configurazione dei jumper.

ATTENTION! Please ensure that the photocell jumpers are only changed with the power to the control panel switched off, including the disconnection of any battery backup. Remove the terminal of the photocell inputs or completely remove the voltage from the digital controller (check that the digital controller is not powered by backup batteries) and check that the TX / RX photocell red power LED is off.

SI RACCOMANDA L'USO DI fotocelle Serie F4ES - F4S / RECOMMENDED USE for Series F4ES - F4S photocells

BATTERY SAVING (AB 03)

BATTERY SAVING + TEST FOTOCPELLULE · PHOTOCELLS TEST (AB 04)

COLLEGAMENTO CON 1 COPPIA FOTOCPELLULE SINCRONIZZATE (MODALITÀ NORMALE, SOLO COPPIA MASTER) CONNECTION WITH 1 SYNCHRONISED PHOTOCCELL PAIR (NORMAL MODE, MASTER PAIR ONLY)

ROSSO = libero da jumper
RED = jumper free

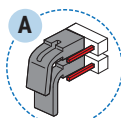
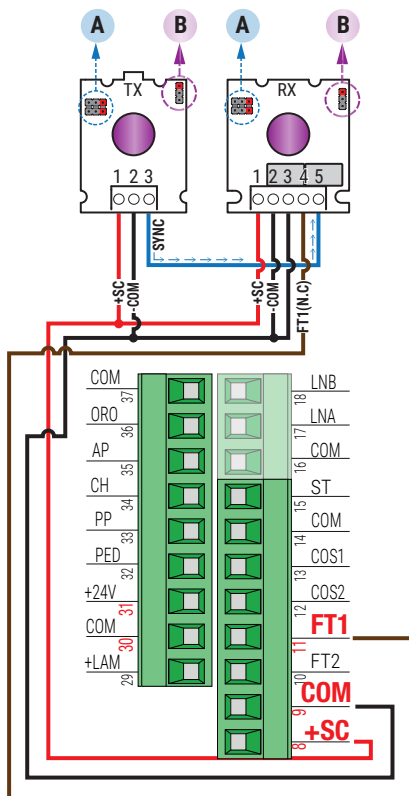

JUMPER DI SINCRONIZZAZIONE
(PER MASTER)
SYNCHRONISATION JUMPER
(FOR MASTER)

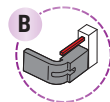

JUMPER DI ALLINEAMENTO
(PER MASTER) OFF*
ALIGNMENT JUMPER
(FOR MASTER) OFF*

12

* Per eseguire la modalità in di allineamento ottico
(NOTA: consultare le istruzioni delle fotocellule):
* To perform optical alignment mode
(NOTE: refer to photocell instructions):

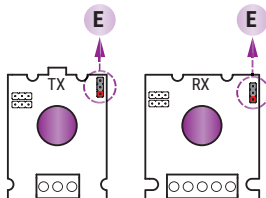

JUMPER DI ALLINEAMENTO ON*
ALIGNMENT JUMPER ON*



ATTENZIONE! Modificare la posizione dei jumper di sincronizzazione o di allineamento solamente quando le fotocellule sono **NON ALIMENTATE!** La configurazione scelta con i jumper viene memorizzata dalle fotocellule solamente all'accensione delle fotocellule.

Scollegare la morsetteria della centrale che fornisce alimentazione alle fotocellule, oppure togliere completamente la tensione al controller digitale (scollegando, se presenti, anche le batterie di backup) e verificare nella fotocellula TX / RX che il LED rosso di alimentazione sia spento; procedere soltanto ora all'impostazione della configurazione dei jumper.

ATTENTION! Please ensure that the photocell jumpers are only changed with the power to the control panel switched off, including the disconnection of any battery backup. Remove the terminal of the photocell inputs or completely remove the voltage from the digital controller (check that the digital controller is not powered by backup batteries) and check that the TX / RX photocell red power LED is off.

SI RACCOMANDA L' USO DI fotocellule Serie F4ES - F4S / RECOMMENDED USE for Series F4ES - F4S photocells

BATTERY SAVING (AB 03)

BATTERY SAVING + TEST FOTOCELLULE · PHOTOCELLS TEST (AB 04)

COLLEGAMENTO CON 2 COPPIE FOTOCELLULE SINCRONIZZATE (MODALITÀ NORMALE, 1 MASTER E 1 SLAVE) CONNECTION WITH 2 SYNCHRONISED PHOTOCCELL PAIRS (NORMAL MODE, 1 MASTER AND 1 SLAVE)

ROSSO = libero da jumper
RED = jumper free

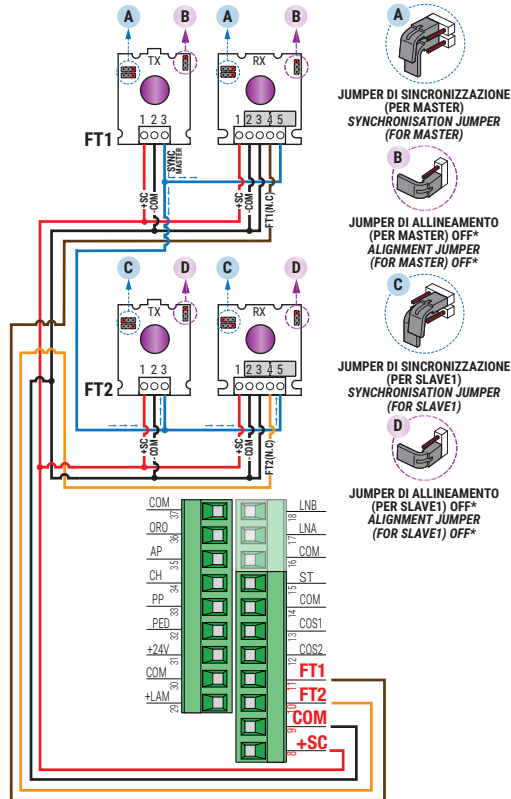

13

A
JUMPER DI SINCRONIZZAZIONE (PER MASTER)
SYNCHRONISATION JUMPER (FOR MASTER)

B
JUMPER DI ALLINEAMENTO (PER MASTER) OFF*
ALIGNMENT JUMPER (FOR MASTER) OFF*

C
JUMPER DI SINCRONIZZAZIONE (PER SLAVE1)
SYNCHRONISATION JUMPER (FOR SLAVE1)

D
JUMPER DI ALLINEAMENTO (PER SLAVE1) OFF*
ALIGNMENT JUMPER (FOR SLAVE1) OFF*

* Per eseguire la modalità in di allineamento ottico (NOTA: consultare le istruzioni delle fotocellule):
* To perform optical alignment mode (NOTE: refer to photocell instructions):

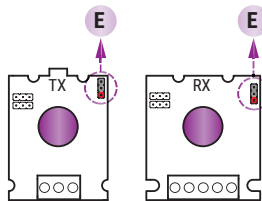

E
JUMPER DI ALLINEAMENTO ON*
ALIGNMENT JUMPER ON*



ATTENZIONE! Modificare la posizione dei jumper di sincronizzazione o di allineamento solamente quando le fotocellule sono **NON ALIMENTATE!** La configurazione scelta con i jumper viene memorizzata dalle fotocellule solamente all'accensione delle fotocellule.

Scollegare la morsetteria della centrale che fornisce alimentazione alle fotocellule, oppure togliere completamente la tensione al controller digitale (scollegando, se presenti, anche le batterie di backup) e verificare nella fotocellula TX / RX che il LED rosso di alimentazione sia spento; procedere soltanto ora all'impostazione della configurazione dei jumper.

ATTENTION! Please ensure that the photocell jumpers are only changed with the power to the control panel switched off, including the disconnection of any battery backup. Remove the terminal of the photocell inputs or completely remove the voltage from the digital controller (check that the digital controller is not powered by backup batteries) and check that the TX / RX photocell red power LED is off.

SI RACCOMANDA L' USO DI fotocellule Serie F4ES - F4S / RECOMMENDED USE for Series F4ES - F4S photocells

SENSORE MAGNETICO DI SBLOCCO
MAGNETIC UNLOCKING SENSOR

14

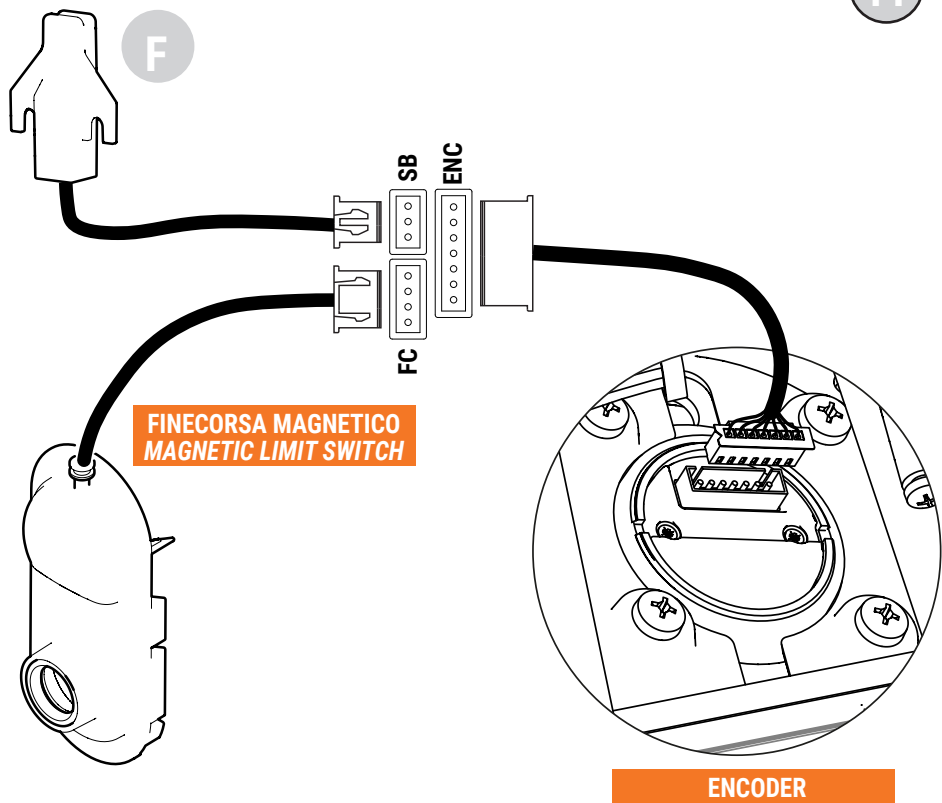

FINECORSA MAGNETICO
MAGNETIC LIMIT SWITCH

ENCODER

è possibile acquistare il finecorsa separatamente
it is possible to purchase the limit switch separately (cod. MC784 / MC785)

1 General safety precautions



WARNING: IMPORTANT SAFETY INSTRUCTIONS **THESE INSTRUCTIONS MUST BE FOLLOWED TO GUARANTEE THE SAFETY OF THE PERSONS** **PRESERVE THESE INSTRUCTIONS**

This installation manual is intended for qualified personnel only.



Failure to observe the information included in this manual may result in personal in serious personal injury or damage to the equipment.

ROGER TECHNOLOGY cannot be held responsible for any damage or injury due to improper use or any use other than the intended usage indicated in this manual.

The installation, electrical connections and adjustments must be performed by qualified personnel, in accordance with best practices and in compliance with applicable regulations.

Read the instructions carefully before installing the product.

Incorrect installation may pose risks.

Before installing the product, make sure it is in perfect condition: In case of doubts, do not use the product and refer exclusively to professionally qualified personnel.

Do not install the product in explosive environment and atmosphere: inflammable gas or vapours constitute serious danger for safety.

Before installing the motor, make all structural modifications related to the safety precautions and to the protection or segregation of areas involving crushing, shearing, dragging risks or any other risks.

WARNING: check that the existing structure fulfils the required resistance and stability specifications.

ROGER TECHNOLOGY is not liable for failure to observe the good practices in the construction of fixtures to be motorised or for deformations that may occur during use.

The safety devices (photocells, sensing edges, emergency stops, etc.) must be installed taking into consideration the following: the regulations and directives in force, the good practices criteria, the installation environment, the operating logic of the system and the forces generated by the motorised door or gate.

The safety devices must protect any areas where there is crushing, shearing, dragging or any other danger in general generated by the motorised door or gate; the installer is advised to check that the moving wings do not have sharp edges or anything that may pose shearing and/or dragging risks.

Ensure that entrapment between the guided part and surrounding fixed parts due to the opening movement of the guided part is avoided.

If it is deemed necessary based on the risk analysis, install sensing edges on the mobile part.

It should be noted that, as provided by the UNI EN 12635 standard, all requirements of the EN 12604 and EN 12453 standards must be fulfilled and, if necessary, also checked.

The European standards EN 12453 and EN 12445 define the minimum safety requirements for the operation of automatic doors and gates. In particular, these standards require the use of force limiting and safety devices (sensing ground plates, photocell barriers, hold-to-run operation, etc.) intended to detect persons or objects in the operating area and prevent collisions in all circumstances.

The installer is required to measure impact forces and select on the control unit the appropriate speed and torque values to ensure that the door or gate remains within the limits defined by the standards EN 12453 and EN 12445.

ROGER TECHNOLOGY cannot be held responsible for any damage or injury caused by the installation of incompatible components which compromise the safety and correct operation of the device.

If the hold-to-run function is active, the installer will have the obligation to check the maximum stop distance or the alternative use of the rubber deformable edge, the closing speed or the gate and in general all aspects indicated by the applicable regulations. Moreover, please note that if the command means is fixed, it must be located in a position guaranteeing the automation system control and operation and the command type and the use type must comply with the UNI EN 12453 standard, prospectus 1 (with the following restrictions: type A or B command or type 1 or 2 use).

In case of hold-to-run operation, remove any potential persons away from the range of action of the automation system's moving parts; the direct commands must be installed at a minimum height of 1.5 m and must not be accessible to the public; moreover, unless the device is key operated, they must be located with a direct view to the motorised part and far from the moving parts.

Apply the signs indicated by the regulations in force for the identification of the dangerous areas.

Each installed device must have a visible indication of the motorised door or gate identification data, in accordance with the EN 13241-1:2001 standard or subsequent revisions.



A switch or an omnipolar cut-off switch with a contact opening of at least 3 mm must be installed on the mains power line; put the cut-off switch in OFF position and disconnect any buffer batteries before performing any cleaning or maintenance operations.

Ensure that an adequate residual current circuit breaker with a 0.03 A threshold and a suitable overcurrent cut-out are installed upstream the electrical installation in accordance with best practices and in compliance with applicable legislation.

When requested, connect the automation to an effective earthing system that complies with current safety standards. The electronic parts must be handled using anti-static conductive wrist straps with grounding wire.

Only use original spare parts when repairing or replacing products.

The installer must provide the user with complete instruction for using the motorised door or gate in automatic, manual and emergency modes, and must hand the operating instructions to the user of the installation upon completion.

Keep away from hinges and moving parts.

Keep out of the area of action of the motorised door or gate while it is moving.

Never try to stop the motorised door or gate while it is moving as this may be dangerous.

The motorised door or gate may be used by children aged 8 and above, by persons with diminished physical, sensory or mental capacity and by persons without the necessary experience and knowledge provided that they are supervised or have received adequate instruction on using the device safely and to ensure that they understand the dangers involved in its operation.

Children must be supervised at all times to ensure that they do not play with the device and that they keep out of the area of action of the motorised door or gate.

Keep remote controls and any other control devices out of the reach of children to prevent the risk of the motorised door or gate being operated unintentionally.

Failure to observe these instructions may lead to danger.

Any repair or technical interventions must be performed by qualified personnel.

The cleaning and maintenance operations must be performed exclusively by qualified personnel.

In the event of a fault or malfunction of the product, turn the main power switch off and have the installation serviced by qualified personnel and refrain from attempting to repair or perform any direct intervention yourself.









The packaging materials (plastic, polystyrene, etc.) should not be discarded in the environment or left within reach of children, as they are a potential source of danger.

Dispose of and recycle the packaging items according to the provisions of the laws in force.

These instructions must be kept and must be made available to any other persons authorised to use the installation.

2 Symbols

The symbols and their meaning in the manual or on the product label are indicated below.

| | |
|---|---|
|  | Generic danger Important safety information. Indicates operations and situations in which the personnel involved must pay close attention. |
|  | Dangerous voltage risk Indicates operations and situations in which the personnel involved must pay close attention to dangerous voltages. |
|  | Useful information Indicates useful information for the installation. |
|  | Refer to the Installation and use instructions Indicates the obligation to refer to the manual or original document, which must be available for future use and must not be damaged in any way. |
|  | Protective earth connection point. |
|  | Indicates the admissible temperature range. |
|  | Alternating current (AC) |
|  | Direct current (DC) |
|  | Symbol for the product disposal according to the WEEE directive. |

3 Product description

The **B70/1T** controller is a unit for the SENSORED control, with a high resolution encoder, of a ROGER Brushless motor for automated sliding gates integrated in the column.



Ensure that the parameter R_l is set correctly. If this parameter is not set correctly, the automation system may not function properly.

ROGER TECHNOLOGY cannot be held responsible for any damage or injury due to improper use or any use other than the intended usage indicated in this manual.

We recommend using only ROGER TECHNOLOGY accessories and control and safety devices. Specifically, we recommend installing **F4ES** or **F4S** series photocells.



For further information, refer to the installation manual of the **TW90** automation system.

5 Description of connections

To access the control connection terminal board, remove the motor cover as shown in figure 1:

- remove the four screws and lift the cover

If the **B71/BC** charger is installed, refer to figure 2:

- pull out the drawer containing the charger and batteries.

Figure 3-4-5-6-7 shows connection diagrams for connecting mains voltage to the motor control unit (**B70/1T**).

5.2 Electrical connections

A switch or an omnipolar cut-off switch with a contact opening of at least 3 mm must be installed on the mains power line; put the cut-off switch in OFF position and disconnect any buffer batteries before performing any cleaning or maintenance operations.

Ensure that an adequate residual current circuit breaker with a 0.03 A threshold and a suitable overcurrent cut-out are installed upstream the electrical installation in accordance with best practices and in compliance with applicable legislation.

For power supply, use a H07RN-F 3G1.5 type electric cable and connect it to the terminals L (brown), N (blue), ⊕ (yellow/green), located inside the automation system.

Strip the insulation from the ends of the power cable wires which will be connected to the terminal (fig. 3-7), and secure the cable with the cable retainer.

Measure the voltage on the primary mains power connection with a tester.

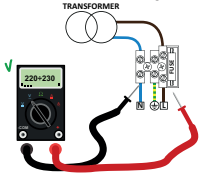

For the Brushless automation system to function correctly, the mains power voltage must be:

- 230V ~ ±10% for the B70/1T control unit.
- 115V ~ ±10% for the B70/1T/115 control unit.

If the detected value does not comply with the above specified values or is not stable, the automation system may NOT operate efficiently.

i Connections to the electrical distribution network and to any other low-voltage conductors in the external section to the electrical panel must be on an independent path and separate from the connections to the command and safety devices (SELV = Safety Extra Low Voltage).

Make sure that the mains power conductors and the accessory wires (24 V) are separated.

The cables must be double insulated, strip them near the relevant connection terminals and lock them with clamps (not supplied).

| | DESCRIPTION |
|------------------------|--|
| | Mains power supply 230 V ~ ±10%, fuse 5x20 T1A connection (115 V ~ ±10% fuse T2A). |
| <p>POWER IN</p> | Power feed input from transformer (or from B71/BC battery charger - if used, fig. 2). N.B.: Ready wired in factory by ROGER TECHNOLOGY. WARNING! With the board powered the battery connected, pay maximum attention to the polarity (see fig. 2). |
| | Connection to ROGER Brushless motor. Connecting B72/BRCL controller for TW90/600/HS High Speed (fig. 4). N.B.: Ready wired in factory by ROGER TECHNOLOGY. WARNING! If the motor wires become disconnected from the terminal board, after reconnecting correctly, the gate travel must be acquired again as described in chapter 10. |

6 Commands and Accessories







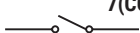

If not installed, safety devices with NC contacts must be jumpered at the COM terminals, or disabled by modifying the parameters *50*, *51*, *53*, *54*, *60*, *73* and *74*.

KEY:

N.A. (Normally Open) .

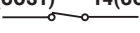
N.C. (Normally Closed).

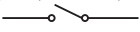
| CONTACT | DESCRIPTION |
|--|---|
| 6  7(COR) | Output (potential free contact) for connecting courtesy light. 230 V~ 100 W - 24 V~/--- 40 W (fig. 7). NOTE: Provide a protective fuse. |
| 6 7(COR) | Error alert contact only, for: <ul style="list-style-type: none"> • Unlocked gate / battery supply error (low battery); • Gate completely open / gate completely closed (fig. 7). The COR output operating mode is managed by parameter <i>20</i> . The voltage level of the battery can be set via parameter <i>B5</i> . |
| 8(+SC)  9(COM) | Connection for gate open indicator lamp. 24 V--- 3 W. The function of the indicator lamp is determined by parameter <i>AB</i> . |
| 8(+SC) 9(COM) | Photocell test connection and/or battery saving (fig. 10-11-12-13) The power feed for the photocell transmitters (TX) may be connected to 8(SC) . Set the parameter <i>AB 02</i> to enable the test function. Each time a command is received, the control unit switches the photocells off and on to check that the contact changes state correctly. Power feeds for all external devices may be connected to reduce battery consumption (if batteries are used). Set <i>AB 03</i> or <i>AB 04</i> . WARNING! If contact 8(SC) is used for the photocell test function or battery saving function, a gate open indicator lamp cannot be connected. |
| 10(FT2)  30(COM) | Input (NC) for connecting photocells FT2 (fig. 8-9-10-11-12-13). The photocells FT2 are configured by default with the following settings: <ul style="list-style-type: none"> - <i>53 00</i>. Photocell FT2 disabled when gate is opening. - <i>54 00</i>. Photocell FT2 disabled when gate is closing. - <i>55 01</i>. The gate opens when an open command is received if photocell FT2 is obstructed. If the photocells are not installed, jumper the terminals 30(COM) - 10(FT2) or set the parameters <i>53 00</i> and <i>54 00</i> . WARNING! Use F4ES or F4S series photocells. |
| 11(FT1)  30(COM) | Input (NC) for connecting photocells FT1 (fig. 11-12-13-14-15-16). The photocells FT1 are configured by default with the following settings: <ul style="list-style-type: none"> - <i>50 00</i>. Photocell FT1 triggers only during gate closure. Photocell is ignored during gate opening. - <i>51 02</i>. Movement is reversed if the photocell is triggered during gate closure. - <i>52 01</i>. The gate opens when an open command is received if photocell FT1 is obstructed. If the photocells are not installed, jumper the terminals 30(COM) - 11(FT1) or set the parameters <i>50 00</i> and <i>51 00</i> . WARNING! Use F4ES or F4S series photocells. |
| 12(COS2)  14(COM) | Input (NC or 8 kOhm) for connecting sensing edge COS2 (fig. 9). The sensing edge is configured by default with the following settings: <ul style="list-style-type: none"> - <i>74 00</i>. The sensing edge COS2 (NC contact) is disabled. If the sensing edge is not installed, jumper the terminals 12(COS2) - 14(COM) or set the parameter <i>74 00</i> . |
| 13(COS1)  14(COM) | Input (NC or 8 kOhm) for connecting sensing edge COS1 (fig. 9). The sensing edge is configured by default with the following settings: <ul style="list-style-type: none"> - <i>73 00</i>. The sensing edge COS1 (NC contact) is disabled. If the sensing edge is not installed, jumper the terminals 13(COS1) - 14(COM) or set the parameter <i>73 00</i> . |
| 15(ST)  14(COM) | STOP command input (NC). The current manoeuvre is arrested if the safety contact opens. N.B.: the controller is supplied with this contact already jumpered by ROGER TECHNOLOGY. |
| 20  19(ANT) | Antenna connector for slot-in radio receiver board. Use RG58 if an external antenna is used; maximum recommended length: 10 m. N.B.: do not make joints in cable. |
| 22(ORO)  21(COM) | Clock timer contact input (N.O.). When the clock function is active, the gate opens and remains open. At the end of the programmed time set with the external device (clock), the gate closes. The function of this command is determined by parameter <i>BD</i> . |

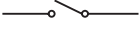
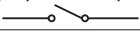
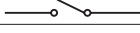
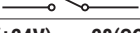
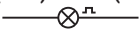
| CONTACT | DESCRIPTION |
|--|--|
| 23(AP) 21(COM)  | Open control signal input (N.O.). WARNING: persistent activation of the opening command prevents automatic reclosure; the automatic reclosure time count is resumed when the opening command is released. |
| 24(CH) 21(COM)  | Close command input (N.O.). |
| 25(PP) 21(COM)  | Step by step mode command input (N.O.). The function of the control is determined by parameter P4 . |
| 26(PED) 21(COM)  | Partial open control signal input (N.O.). Set by default to 50% of completely open position. |
| 27(+24V) 28(COM) | Power feed for external devices. See technical characteristics. Connecting B72/BRCL power unit for High Speed versions (fig. 5) |
| 29(LAM) 28(COM)  | Connection for flashing light (24 V $\overline{\text{---}}$ - duty cycle 50%). The settings for the pre-manoeuve flashing warning signal may be selected with parameter P5 , while the flashing mode is set with parameter 7B . |
| ENC | Connector for connecting to encoder installed on motor. WARNING! Always disconnect from electrical power before disconnecting or connecting the encoder cable. In case of encoder replacement, repeat the acquisition procedure. N.B.: Ready wired in factory by ROGER TECHNOLOGY. |
| FC | Connector (N.C. contacts) for connecting magnetic limit switch (see figure 14 - detail F). The gate stops when the limit switch is activated. WARNING: repeat the travel acquisition procedure after each adjustment to the limit switches. N.B.: Ready wired in factory by ROGER TECHNOLOGY. |
| SB | Connector (N.C.) for connecting release contact. Turning the motor release pin stops the gate stops and no command signals are accepted. WARNING! Once the release pin has been reset, if the gate is in an intermediate position, without activating a limit switch (if one is installed), the control unit starts a position recovery procedure (see chapter 20) N.B.: Ready wired in factory by ROGER TECHNOLOGY. |
| RECEIVER CARD | Connector for plug-in radio receiver board. The control unit has two radio remote control functions by default: <ul style="list-style-type: none"> • PR1 - step mode command (modifiable with parameter 7B). • PR2 - partial opening command (modifiable with parameter 77). The programming buttons PR1 and PR2 are also accessible with the cover closed (see fig. 17). |
| BATTERY CHARGER B71/BC | In the event of a mains power loss, the controller unit is powered by the batteries. When battery power is used, BAtE is shown on the display and the flashing light flashes briefly at intervals until mains power is restored or until the battery voltage drops below the minimum permissible limit. In this case, bLlD (Battery Low) is shown on the display and the controller unit accepts no commands. WARNING! the batteries must always be connected to the electronic controller unit in order to charge. Periodically (at least every 6 months), check that the battery is in good working order. |
| 2x12 V$\overline{\text{---}}$ 1,2 Ah. or 2x12 V$\overline{\text{---}}$ 4,5 Ah Only AGM type | Two battery kits are available: <ul style="list-style-type: none"> • Two 12 V$\overline{\text{---}}$, 1.2 Ah batteries installed in the automation system itself. • Two 12 V$\overline{\text{---}}$, 4.5 Ah batteries installed in an external case. For more information, refer to the installation manual for the B71/BC battery charger. |
| BATTERY CHARGER B71/BC | To install the charger and 12V 1.2 Ah batteries: <ul style="list-style-type: none"> • Remove the cover. • Pull out the tray located above the control unit. • Insert the B71/BC charger board into the prepared slot. • Disconnect the cables coming from the transformer from the POWER IN terminal of the control unit and connect them to the charger terminal. • Connect the red-black cables of the wiring, supplied with the battery, to the POWER IN terminal of the control unit. • Place the 12V 1.2 Ah batteries in the prepared compartment, paying attention to the polarities. • Close the cover. To reduce battery consumption, the positive power supply of the photocell transmitters can be connected to the SC terminal (see fig. 13-14-15-16). Set AB 03 or AB 04 . In this way, when the gate is fully open or fully closed, the control unit removes power from the devices. |
| WIFI | Connector for B74/BCONNECT WiFi IP device. This IP device allows, using any internet browser, the complete management of the control panel both in proximity (point-to-point connection) and via cloud (remote connection). |

7 Function buttons and display

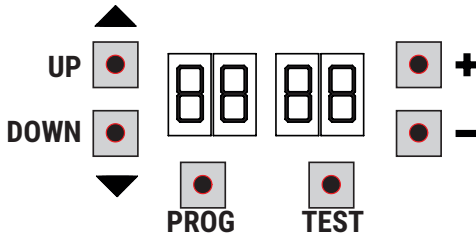

| BUTTON | DESCRIPTION |
|--------|----------------------------------|
| UP ▲ | Next parameter |
| DOWN ▼ | Previous parameter |
| + | Increase value of parameter by 1 |
| - | Decrease value of parameter by 1 |
| PROG | Travel acquisition |
| TEST | Activate TEST mode |

- Press the UP ▲ and/or DOWN ▼ buttons to view the parameter you intend to modify.
- Use the + and - buttons to modify the value of the parameter. The value starts to flash.
- Press and hold the + or - button to scroll quickly through values, to modify the parameter more quickly.
- To save the new value, wait a few seconds or move onto another parameter with the UP ▲ or DOWN ▼ button. The display flashes rapidly to indicate that the new value has been saved.
- Parameters can only be modified while the motor is not running. Parameters can be viewed at any time.

8 Switching on or commissioning

Power the control unit.
 The firmware version of the control unit is displayed briefly.
 Version installed r1.00.

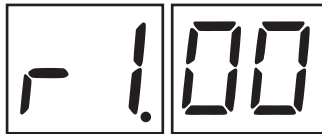

Immediately afterwards, the displays enters the commands and safety device status mode. See chapter 9.

9 Display function modes

9.1 Parameter display mode

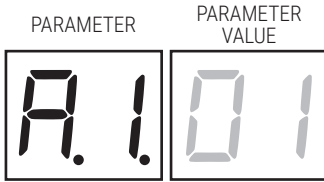

See chapter 12 for detailed descriptions of the parameters.

9.2 Command and safety device status display mode

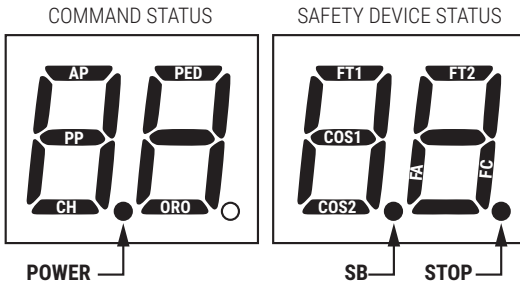

COMMAND STATUS:

The command status indicators on the display are normally OFF.

They ILLUMINATE when a command is received (e.g.: when a step mode command is received, the segment PP illuminates).

| SEGMENT | COMMAND |
|--------------|-------------------|
| <i>AP</i> | open |
| <i>PP</i> | step-by-step mode |
| <i>CH</i> | close |
| <i>PEd</i> | partial opening |
| <i>O-r-O</i> | clock |

SAFETY DEVICE STATUS:

The safety device status indicators ON the display .

If an indicator is OFF, the relative device is in alarm state or is not connected.

The an indicator is FLASHING, the relative device has been disabled with a specific parameter.

| SEGMENT | SAFETY |
|--------------|--------------------------|
| <i>FT 1</i> | FT1 photocells |
| <i>FT 2</i> | FT2 photocells |
| <i>COS 1</i> | COS1 sensing edge |
| <i>COS 2</i> | COS2 sensing edge |
| <i>FA</i> | gate open limit switch |
| <i>FC</i> | gate closed limit switch |
| <i>Sb</i> | release pin rotated |

9.3 TEST mode

The TEST mode is used to test activation of the commands and safety devices with visual confirmation. To activate the mode, press the TEST button with the automatic door system at rest. If the gate is moving, pressing TEST stops the gate. Pressing the button again enables TEST mode. If the flashing light and the gate open indicator lamp illuminate for one second each time a control is used or a safety device is activated.

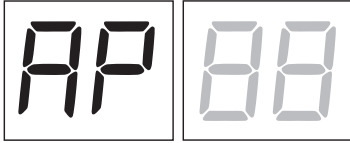

The command signal status is shown on the left hand side of the display for 5 seconds, ONLY when the respective command signal is active (AP, CH, PP, PE, OR). For example, if the gate open command is activated, the letters AP appear on the display.

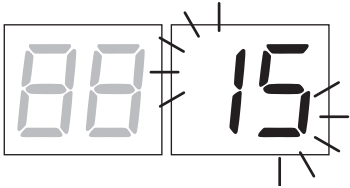

The status of the safety devices/inputs is shown on the right hand side of the display. The number of the terminal relative to the safety device in alarm state flashes.

When the gate is completely open or completely closed, FR or FC is shown on the display to indicate that the gate has reached the gate open limit switch FR or gate closed limit switch FC.

Example: STOP contact in alarm state

| | |
|---------|--|
| 00 | No safety device in alarm state and no limit switch activated. |
| 5b (Sb) | Release pin rotated. |
| 15 | STOP contact (N.C.) open. If there is no STOP switch, jumper the contact. |
| 13 | Sensing edge contact COS1 (N.C.) is open. Check connection. If sensing edge is not installed, disable with 73 00. |
| 12 | Sensing edge contact COS2 (N.C.) is open. Check connection. If sensing edge is not installed, disable with 74 00. |
| 11 | Photocell contact FT1 (N.C.) is open. Check connection. If photocell is not installed, disable with 50 00. |
| 10 | Photocell contact FT2 (N.C.) is open. Check connection. If photocell is not installed, disable with 53 00. |
| FE | Both limit switches in error state. Check connections and settings of limit switches. |
| FR | If gate is open, gate open limit switch is detected. |
| FC | If gate is closed, gate closed limit switch is detected. |

NOTE: If one or more contacts are open, the gate will not open or close. This does not apply for the limit switch signal state, however, which is shown on the display but does not prevent normal operation of the gate.

If more than one safety device is in alarm state, once the problem relative to the first device is resolved, the alarm for the next device is displayed. Any further alarm states are also displayed with the same logic.

Press the TEST button again to exit test mode.

After 10 seconds with no user input, the display returns to command and safety device state display mode.

9.4 Standby mode

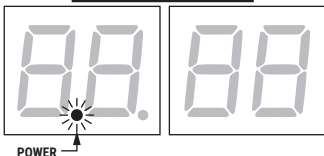

This mode is activated after 30 minutes with no user input. The POWER LED flashes slowly.

Press UP ▲, DOWN ▼, +, - to reactivate the control unit.

NOTE: If a safety password (only if active) is unlocked, to adjust the parameter settings, the password is automatically reactivated in Stand By mode.



10 Travel acquisition

i For the system to function correctly, the gate travel must be acquired by the control.

10.1 Before starting:

1. Select the automation system model installed with the parameter *A 1*.

KEY:  **HIGH SPEED Motor**  **REVERSIBLE Motor**

| SELECTION | MODEL | MOTOR TYPE | CONFIGURATION |
|---------------|--------------------|---|---|
| <i>A 1 01</i> | TW90/800 | / | 800kg IRREVERSIBLE |
| <i>A 1 02</i> | TW90/600/HS |  | 600kg HIGH SPEED (see chapter 13 "Special Parameters for High Speed Motor") |
| <i>A 1 03</i> | TW90/800/R |  | 800kg REVERSIBLE (see chapter 14 "Special Parameters for Reversible Motor") |

2. Select the position of the motor relative to the gate with the parameter *7 1*. The default setting for this parameter is with the motor installed on the right hand side of the gate (seen from interior side).

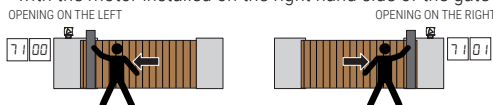

3. If limit switches enabled (*50 0 1*): adjust limit switches so that, after activation, the gate stops slightly in advance of the mechanical stop

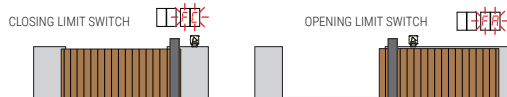

4. Check that the operator present function is not enabled (*A7 00*).



5. Move the gate into the closed position.

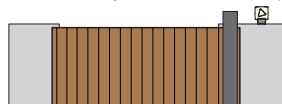

6. Press **TEST** (see TEST mode in chapter 9) and check the command signal and safety device states. If any safety devices are not installed, jumper the relative contact or disable the device from the relative parameter (*50, 5 1, 53, 54, 60, 73 and 74*).

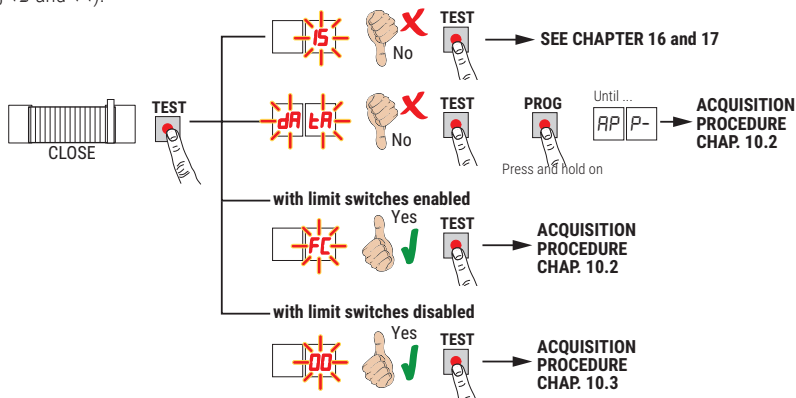

10.2 Acquisition procedure:

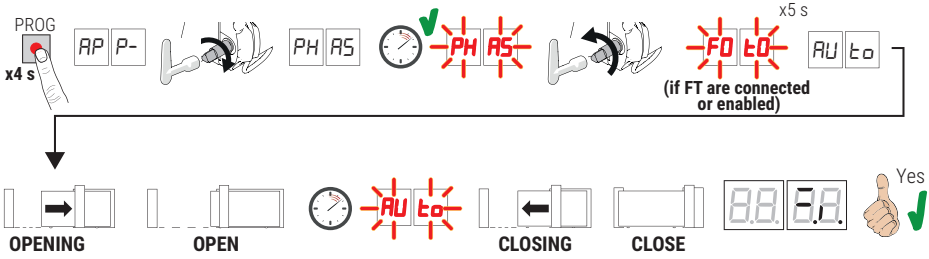

- Press and hold PROG for 4 seconds. *AP P-* is shown on the display.
- Turn the release pin, the message *PH RS* appears on the display after a few seconds. The controller unit launches a calibration procedure. The operating parameters of the motor are determined during calibration.
- If the motor calibration procedure is successful, the message *PH RS* flashes on the display.
- Return release pin. The acquisition procedure now starts.
- *FO EO* is shown on the display (only if parameters *SO, S I, S3, S4* are not disabled). Keep away from the photocell beam within 5 s, to prevent interrupting the procedure.
- *AU EO* is shown on the display and the gate starts opening at low speed.
- The gate stops briefly when it reaches the gate open limit switch. *AU EO* flashes on the display.
- The gate closes until it reaches the gate closed limit switch.

If the acquisition procedure is completed successfully, the display enters the command and safety device state display mode.

If the following error messages are shown on the display, repeat the acquisition procedure:

- *no PH*: calibration procedure failed.
- *AP PE*: acquisition error. Press the **TEST** button to clear the error, and check the safety device in alarm state.
- *AP PL*: travel length error. Press the **TEST** button to clear the error, and check that gate is completely closed.

ATTENTION: if the acquisition procedure was successful **BUT** the space between the leaf (stopped at the limit switch) and the mechanical stop is not as desired (at least 3cm), move the limit switch and **REPEAT THE ACQUISITION PROCEDURE**. Ensure that **AT LEAST** 3 centimetres remain between the leaf stop and the mechanical stop.

i For more information, see chapter 16 "Alarms and faults".

10.3 Acquisition procedure without limit switches

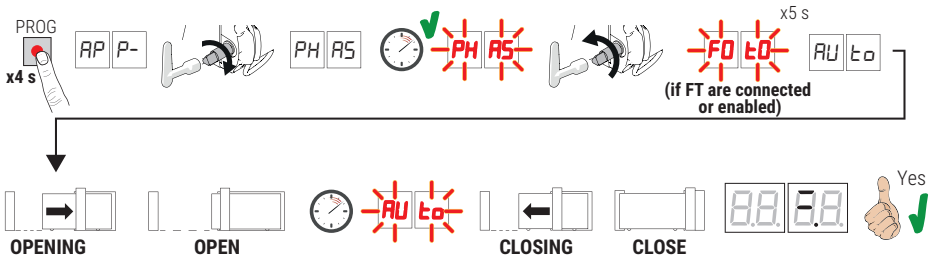

- Press and hold PROG for 4 seconds. *AP P-* is shown on the display.
 - Raise the release lever, the message *PH AS* appears on the display after a few seconds. The controller unit launches a calibration procedure. The operating parameters of the motor are determined during calibration.
 - If the motor calibration procedure is successful, the message *PH AS* flashes on the display.
 - Return release pin. The acquisition procedure now starts.
 - *FO EO* is shown on the display (only if parameters *50*, *51*, *53*, *54* are not disabled). Keep away from the photocell beam within 5 s, to prevent interrupting the procedure.
 - When the mechanical opening stop is reached, the gate stops briefly. *AU EO* flashes on the display.
 - The gate closes again until the mechanical closing stop is reached.
- If the acquisition procedure is completed successfully, the display enters the command and safety device state display mode. The gate retracts by the number of rotor revolutions selected in parameter *26*.



If the following error messages are shown on the display, repeat the acquisition procedure:

- *no PH*: calibration procedure failed.
- *AP PE*: acquisition error. Press the TEST button to clear the error, and check the safety device in alarm state.
- *AP P.L / AP P.T*: travel length error. Press the TEST button to clear the error, and check that gate is completely closed.

⚠ ATTENTION: if the learning procedure was successful **BUT** the space left between the gate leaf and the mechanical stop is not as desired, increase the value of parameter *26*. Check that when fully open, the sash maintains the same distance from the mechanical stop, adjust parameter *25* if necessary. Ensure that **AT LEAST** 3 centimetres remain between the leaf stop and the mechanical stop.

i For more information, see chapter 16 "Alarms and faults".

11 Index of parameters

| PARAM. | FACTORY DEFAULT | DESCRIPTION | PAGE |
|--|-----------------|--|------|
| R1 | see chap. 12 | Selecting automation system model | 67 |
| R2 | 00 | Automatic closure after pause time (from gate completely open) | 67 |
| R3 | 00 | Automatic gate closing after mains power outage | 67 |
| R4 | 00 | Selecting step mode control function (PP) | 67 |
| R5 | 00 | Pre-flashing | 67 |
| R6 | 00 | Condominium function for partial open command (PED) | 67 |
| R7 | 00 | Enabling operator present function | 68 |
| R8 | 00 | Gate open indicator / photocell test function and "battery saving" | 68 |
| 11 | 04 | Setting deceleration during opening (and closing for TW90/800) | 68 |
| 12  | 04 | Setting deceleration during closing (High Speed - Reversible only) | 68 |
| 13 | 05 | Setting gate open limit switch constant speed approach distance | 68 |
| 14 | 05 | Setting gate closed limit switch constant speed approach distance | 68 |
| 15 | 50 | Partial opening adjustment (%) | 68 |
| 16 | 10 | Adjusting automatic closing time after partial opening | 68 |
| 20 | 00 | COR output operating mode | 68 |
| 21 | 30 | Setting automatic closing time | 68 |
| 22 | 00 | Enabling of management for opening with automatic re-closure exclusion | 69 |
| 23 | 03 | Tolerance on opening stop | 69 |
| 24 | 03 | Tolerance on closing stop | 69 |
| 25 | 03 | Advance on stop on full opening | 69 |
| 26 | 03 | Advance on stop on full closing | 69 |
| 27 | 03 | Setting reverse time after activation of sensing edge or obstacle detection (crush prevention) | 69 |
| 30 | 05 | Setting motor torque | 69 |
| 31 | 15 | Setting obstacle impact force sensitivity | 69 |
| 33 | 04 | Setting start acceleration during opening (and closing for TW90/800) | 70 |
| 34  | 04 | Setting start acceleration during closing (High Speed - Reversible only) | 70 |
| 36 | 00 | Enabling maximum torque boost at start of manoeuvre | 70 |
| 37 | 00 | Setting motor torque during position recovery | 70 |
| 40 | 05 | Setting opening speed (and closing for TW90/800) | 70 |
| 41  | 05 | Setting closing speed (High Speed -Reversible only) | 70 |
| 42 | 03 | Setting end of manoeuvre constant approach speed | 70 |
| 49 | 01 | Setting number of automatic closure attempts after activation of sensing edge or obstacle detection (crush protection) | 70 |
| 50 | 00 | Setting photocell mode during gate opening (FT1) | 71 |
| 51 | 02 | Setting photocell mode during gate closing (FT1) | 71 |
| 52 | 01 | Photocell (FT1) mode with gate closed | 71 |
| 53 | 00 | Setting photocell mode during gate opening (FT2) | 71 |

| PARAM. | FACTORY DEFAULT | DESCRIPTION | PAGE |
|--------|-----------------|---|------------|
| 54 | 00 | Setting photocell mode during gate closing (FT2) | 71 |
| 55 | 01 | Photocell (FT2) mode with gate closed | 71 |
| 56 | 00 | Enable close command 6 s after activation of photocell (FT1-FT2) | 71 |
| 60 | 00 | Limit switch enabling | 72 |
| 65 | 05 | Setting motor stop distance | 72 |
| 71 | 01 | Selecting installation position of motor relative to gate (seen from interior side) | 72 |
| 73 | 00 | Configuring sensing edge COS1 | 72 |
| 74 | 00 | Configuring sensing edge COS2 | 72 |
| 76 | 00 | Configuring radio channel 1 (PR1) | 72 |
| 77 | 01 | Configuring radio channel 2 (PR2) | 72 |
| 78 | 00 | Configuring flashing light frequency | 73 |
| 79 | 60 | Selecting courtesy light mode | 73 |
| 80 | 00 | Clock contact configuration | 73 |
| 81 | 00 | Enable safeguarded gate closure/opening | 73 |
| 82 | 03 | Setting safeguarded closure/opening activation time | 73 |
| 85 | 00 | Selection of the battery operation management | 73 |
| 86 | 00 | Selection of the battery operation limitations | 73 |
| 87 | 00 | Selection of the battery type and consumption reduction | 74 |
| 90 | 00 | Restoring factory default values | 74 |
| n0 | 01 | HW version | 74 |
| n1 | 23 | Year of manufacture | 74 |
| n2 | 45 | Week of manufacture | 74 |
| n3 | 67 | Serial number | 74 |
| n4 | 89 | | 74 |
| n5 | 01 | | 74 |
| n6 | 23 | | FW version |
| o7 | 01 | View manoeuvre counter | 74 |
| o0 | 23 | | 74 |
| o1 | 45 | | 74 |
| h0 | 01 | View manoeuvre hour counter | 74 |
| h1 | 23 | | 74 |
| d0 | 01 | View control unit days on counter | 74 |
| d1 | 23 | | 74 |
| P1 | 00 | Password | 75 |
| P2 | 00 | | 75 |
| P3 | 00 | | 75 |
| P4 | 00 | | 75 |
| CP | 00 | Changing password | 75 |

12 Parameters menu

PARAMETER PARAMETER
VALUE



| | | |
|--------------|---|--|
| A1 01 | Selecting automation system model WARNING! If this parameter is not set correctly, the automation system may not function properly. N.B.: in the event of a reset to restore the default parameters, this parameter must be set again manually. | |
| 01 | TW90/800 - IRREVERSIBLE motor for gate leaves up to 800 Kg. | |
| 02 | TW90/600/HS - IRREVERSIBLE motor for gate leaves up to 600 Kg. | |
| 03 | TW90/800/R - REVERSIBLE motor for gate leaves up to 800 kg | |
| A2 00 | Automatic closure after pause time (from gate completely open) | |
| 00 | Disabled. | |
| 01-15 | From 1 to 15 of gate closure attempts after photocell is triggered. Once the number of attempts set is reached, the gate remains open. | |
| 99 | The gate tries to close indefinitely. | |
| A3 00 | Automatic gate closing after mains power outage | |
| 00 | Disabled. The gate does not close automatically when mains power is restored. | |
| 01 | Enabled. If the gate is NOT completely open, when mains power is restored, the gate closes after a 5 second warning signalled with the flashing light (independently of the value set with the parameter A5). The gate closes in "position recovery" mode (see chapter 20). | |
| A4 00 | Selecting step mode control function (PP) | |
| 00 | Open-stop-close-stop-open-stop-close... | |
| 01 | Condominium function: the gate opens and closes after the set automatic closing time. The automatic closing timer restarts if a new step mode command is received. Step mode commands are ignored while the gate is opening. This allows the gate to open completely and prevents the gate from closing when not required. If automatic closing is disabled (A2 00), the condominium function automatically attempts a closing manoeuvre A2 01. | |
| 02 | Condominium function: the gate opens and closes after the set automatic closing time. The automatic closing timer does NOT restart if a new step mode command is received. Step mode commands are ignored while the gate is opening. This allows the gate to open completely and prevents the gate from closing when not required. If automatic closing is disabled (A2 00), the condominium function automatically attempts a closing manoeuvre A2 01. | |
| 03 | Open-close-open-close. | |
| 04 | Open-close-stop-open. | |
| A5 00 | Pre-flashing | |
| 00 | Disabled. The flashing light is activated during opening and closing manoeuvres. | |
| 01-10 | Flashing warning signal for 1 to 10 seconds prior to every manoeuvre. | |
| 99 | 5 second flashing warning signal prior to closing manoeuvre. | |
| A6 00 | Condominium function for partial open command (PED) | |
| 00 | Disabled. The gate opens partially in step mode: open-stop-close-stop-open... | |
| 01 | Enabled. Partial commands are ignored during gate opening. | |

| | |
|--------------|--|
| A7 00 | Enabling operator present function |
| 00 | Disabled. |
| 01 | Enabled. The open (AP) or close (CH) button must be pressed continuously to operate the gate. The gate stops when the button is released. |
| A8 00 | Gate open indicator / photocell test function and "battery saving" |
| 00 | The indicator is off when the gate is closed, and steadily lit during manoeuvres and when the gate is open. |
| 01 | The indicator flashes slowly during opening manoeuvres, and is lit steadily when the gate is completely open. It flashes quickly during closing manoeuvres. If the gate is stopped in an intermediate position, the lamp extinguishes twice every 15 seconds. |
| 02 | Set 02 if the output SC is used for the photocell test. See fig. 10-11. |
| 03 | Set to 03 if the output SC is used for the "battery saving" function. See fig. 12-13. When the gate is completely open or closed, the controller unit deactivates any accessories connected to terminal SC to reduce battery consumption. |
| 04 | Set to 04 if the output SC is used for the "battery saving" function and photocell test function. See fig. 12-13. |
| 11 04 | Setting deceleration during opening and closing |
| 12 04 | See chapters 13 and 14 |
| 01-05 | 01= the gate decelerates near the mechanical stop/limit switch ... 05= the gate decelerates long before the mechanical stop/limit switch. |
| 13 05 | Setting gate open limit switch constant speed approach distance N.B.: the manoeuvre speed is set with parameter 42. After decelerating, the gate completes the distance to the limit switch at constant speed. |
| 14 05 | Setting gate closed limit switch constant speed approach distance N.B.: the manoeuvre speed is set with parameter 42. After decelerating, the gate completes the distance to the limit switch at constant speed. |
| 05-40 | 05= Approximate 15 cm distance; ... 10= Approximate 30 cm distance; ... 40= Approximate 120 cm distance. |
| 15 50 | Partial opening adjustment (%) N.B.: This parameter is set to 50% (half of total gate travel) by default. |
| 10-99 | From 10% to 99% of total gate travel. |
| 16 10 | Adjusting automatic closing time after partial opening The countdown starts when the pedestrian opening is reached, as defined in paragraph 15. |
| 00-90 | Pause time settable from 00 to 90 s. |
| 92-99 | Pause time settable from 2 to 9 min. |
| 20 00 | Type of signaling provided by COR output |
| 00 | STANDARD operation managed by parameter 79 |
| 01 | Contact closed if the control unit is working properly. Contact open if central locked in alarm. |
| 02 | Contact closed if the control unit is powered by the mains or charged battery. Open contact due to a fault: control unit powered by low battery (voltage level set by par. 85) or with error alert BLD (the control unit no longer accept commands). |
| 03 | Closed contact if none of the fault related situations 1 and 2 occurs. Open contact if at least one of the fault related situations 1 and 2 occurs. |
| 04 | Closed contact if the gate is not completely open. Open contact if the gate is completely open. |
| 05 | Closed contact if the gate is not completely closed. Open contact if the gate is completely closed. |
| 21 30 | Setting automatic closing time The timer starts from the gate open state and continues for the set time. Once the set time is reached, the gate closes automatically. The timer count restarts if a photocell is triggered. |
| 00-90 | Pause time settable from 00 to 90 s. |
| 92-99 | Pause time settable from 2 to 9 min. |

| | |
|--------------|---|
| 22 00 | Enabling of management for opening with automatic re-closure exclusion If enabled, the exclusion of automatic re-closure only applies for the command selected via the parameter. For example: if you set 220 1, automatic re-closure is excluded following an AP command, but it is activated following a PP or PED command. NOTE: The command has open-stop-close or close-stop-open sequence activation function. |
| 00 | Disabled. |
| 01 | An AP (opening) command activates the opening manoeuvre. When the gate is fully open, automatic reclosure is excluded. A subsequent AP (open) command activates the closing operation. |
| 02 | A PP (step-by-step) command activates the opening manoeuvre. When the gate is fully open, automatic reclosure is excluded. A subsequent PP (step-by-step) command activates the closing operation. |
| 03 | A PED (partial opening) command activates the partial opening operation. Automatic reclosure is excluded. A subsequent PED (partial opening) command activates the closing operation. |
| 23 03 | Tolerance on opening stop NOTE: parameter are visible if limit switches are disabled on parameter 60 (60 00); adjust the value of par.23 to be less than or equal to that of par.25 |
| 01-05 | 01= minimum tolerance (rotor revolutions) ... 05= maximum tolerance (rotor revolutions) |
| 24 03 | Tolerance on closing stop NOTE: parameter are visible if limit switches are disabled on parameter 60 (60 00) ; adjust the value of par.24 to be less than or equal to that of par.26 |
| 01-05 | 01= minimum tolerance (rotor revolutions) ... 05= maximum tolerance (rotor revolutions) |
| 25 03 | Advance on stop on full opening NOTE: parameter are visible if limit switches are disabled on parameter 60 (60 00) To set an advance on stop of approx. 3cm set the following values for parameter 25: 04 for TW90/800 03 for TW90/600/HS 02 for TW90/800/R |
| 01-15 | 01= minimum advance (rotor revolution) ... 15= maximum advance (rotor revolutions) |
| 26 03 | Advance on stop on full closing NOTE: parameter are visible if limit switches are disabled on parameter 60 (60 00) To set an advance on stop of approx. 3cm set the following values for parameter 26: 04 for TW90/800 03 for TW90/600/HS 02 for TW90/800/R |
| 01-15 | 01= minimum advance (rotor revolution) ... 15= maximum advance (rotor revolutions) |
| 27 03 | Setting reverse time after activation of sensing edge or obstacle detection (crush prevention) This sets the reverse manoeuvre time after activation of the sensing edge or the obstacle detection system. The gate comes to a stop after reversal dues to activation of the sensing edge or obstacle detection system at the end of manoeuvre deceleration speed. As a result, the effective reversal manoeuvre time is slightly longer than the set time. |
| 00-60 | From 0 to 60 s. |
| 30 05 | Setting motor torque Increasing or decreasing the value of the parameter increases or decreases motor torque and, as a result, adjusts obstacle detection sensitivity. Use values below 03 ONLY for particularly lightweight installations not exposed to severe weather conditions (strong winds or very cold temperatures). |
| 01-09 | 01= -35%; 02= -25%; 03= -16%; 04= -8% (reduced motor torque = increased sensitivity). 05= default motor torque setting. 06= +8%; 07= +16%; 08= +25%; 09= +35% (increased motor torque = reduced sensitivity). |
| 31 15 | Setting obstacle impact force sensitivity If the reaction time to obstacle impact force is too long, reduce the value of the parameter. If the impact force exerted on obstacles is too high, reduce the value of parameter 30. |
| 01-10 | Low motor torque: 01= minimum obstacle impact force ... 10= maximum obstacle impact force N.B.: only use these settings if the medium motor torque values are not suitable for the installation. |
| 11-16 | Medium motor torque. Recommended setting for adjusting force settings correctly. 11= minimum obstacle impact force ... 16= maximum obstacle impact force. |
| 17 | 70% of maximum motor torque, 1 s of reaction time. Sensing edge is compulsory. |
| 18 | 80% of maximum motor torque, 2 s of reaction time. Sensing edge is compulsory. |

| | |
|--------------|--|
| 19 | Maximum motor torque, 3 s of reaction time. Sensing edge is compulsory. |
| 20 | Maximum motor torque, 5 s of reaction time. Sensing edge is compulsory. |
| 33 04 | Setting start acceleration during opening and closing |
| 34 04 | See chapters 13 and 14 |
| 0 1-05 | 0 1= the gate accelerates rapidly at start of manoeuvre ... 05= the gate accelerates slowly and progressively at start of manoeuvre. |
| 36 00 | Enabling maximum torque boost at start of manoeuvre If this parameter is enabled, each time the motor starts a manoeuvre, maximum torque is produced for a maximum of 5 seconds, or for the time necessary for the gate to open by approximately 65 cm. N.B: in the case of HIGH SPEED motors, a motor boost mode is implemented for 2 seconds after each gate start, regardless of the setting of parameter 36. |
| 00 | Disabled. |
| 0 1 | Enabled at start of opening manoeuvre only (including position recovery). The motor starting current function is only enabled for closing manoeuvres if the gate position is known and the gate is over to 2 metres from the completely closed position. |
| 02 | Enabled for all starts (including position recovery). |
| 37 00 | Setting motor torque during position recovery Adjust motor torque with parameter 37 if, during position recovery, the values set with parameters 30 and 3 1 are insufficient to allow the gate to complete the manoeuvre. If position recovery is not completed, normal gate operation will not be resumed. |
| 00 | The response of the obstacle detection system depends solely on the values set for parameters 30 and 3 1. |
| 0 1 | The response of the obstacle detection system depends on the values set for parameters 30 and 3 1 and on the maximum current value stored during travel acquisition. |
| 02 | The response of the obstacle detection system is a 70% reduction in maximum torque for a period of 1 s. |
| 03 | The response of the obstacle detection system is a 80% reduction in maximum torque for a period of 2 s. |
| 04 | The response of the obstacle detection system is a 100% reduction in maximum torque for a period of 3 s. |
| 05 | The response of the obstacle detection system is a 100% reduction in maximum torque for a period of 5 s. |
| 40 05 | Setting opening and closing speed |
| 41 05 | See chapters 13 and 14 |
| 0 1-05 | 0 1= 60% minimum speed, 02= 70%, 03= 80%, 04=90%, 05= 100% maximum speed. |
| 42 03 | Setting end of manoeuvre constant approach speed Once deceleration is complete, the gate continues to the limit switch at constant speed. The distance is set with the parameters 13 and 14. |
| 0 1-05 | 0 1= 250 RPM; 02= 300 RPM; 03= 350 RPM; 04= 400 RPM; 05= 450 RPM; 06= 500 RPM; 07= 550 RPM; 08= 600 RPM NOTE: The minimum and maximum approaching speeds vary according to the installed motor model. The settings are divided in constant size steps. Indicative values: TW90/800 from approximately 2 m/min to 5 m/min TW90/600/HS from approximately 3 m/min to 8 m/min TW90/800/R from approximately 5 m/min to 12 m/min |
| 49 01 | Setting number of automatic closure attempts after activation of sensing edge or obstacle detection (crush protection) |
| 00 | No automatic closure attempts. |
| 0 1-03 | From 1 to 3 automatic closure attempts. We recommend setting a value equal to or lower than the value set for parameter 02. Automatic closure is only performed if the gate is completely open. |

| | |
|--------------|---|
| 50 00 | Setting photocell mode during gate opening (FT1) |
| 00 | DISABLED. Photocell is not active or not installed. |
| 01 | STOP. The gate stops and remains stationary until the next command is received. |
| 02 | IMMEDIATE REVERSE. The gate reverses immediately if the photocell is activated during gate opening. |
| 03 | TEMPORARY STOP. The gate stops as long as the photocell is obstructed. The gate resumed opening when the photocell is cleared. |
| 04 | DELAYED REVERSE. The gate stops if the photocell is obstructed. The gate closes when the photocell is cleared. |
| 51 02 | Setting photocell mode during gate closing (FT1) |
| 00 | DISABLED. Photocell is not active or not installed. |
| 01 | STOP. The gate stops and remains stationary until the next command is received. |
| 02 | IMMEDIATE REVERSE. The gate reverses immediately if the photocell is activated during gate closure. |
| 03 | TEMPORARY STOP. The gate stops as long as the photocell is obstructed. The gate resumed closing when the photocell is cleared. |
| 04 | DELAYED REVERSE. The gate stops if the photocell is obstructed. The gate opens when the photocell is cleared. |
| 52 01 | Photocell (FT1) mode with gate closed This parameter is not visible if AB 02 , AB 03 or AB 04 is set. |
| 00 | If the photocell is obstructed, the gate cannot open. |
| 01 | The gate opens when an open command is received, even if the photocell is obstructed. |
| 02 | The photocell sends the gate open command when obstructed. |
| 53 00 | Setting photocell mode during gate opening (FT2) |
| 00 | DISABLED. Photocell is not active or not installed. |
| 01 | STOP. The gate stops and remains stationary until the next command is received. |
| 02 | IMMEDIATE REVERSE. The gate reverses immediately if the photocell is activated during gate opening. |
| 03 | TEMPORARY STOP. The gate stops as long as the photocell is obstructed. The gate resumed opening when the photocell is cleared. |
| 04 | DELAYED REVERSE. The gate stops if the photocell is obstructed. The gate closes when the photocell is cleared. |
| 54 00 | Setting photocell mode during gate closing (FT2) |
| 00 | DISABLED. Photocell is not active or not installed. |
| 01 | STOP. The gate stops and remains stationary until the next command is received. |
| 02 | IMMEDIATE REVERSE. The gate reverses immediately if the photocell is activated during gate closure. |
| 03 | TEMPORARY STOP. The gate stops as long as the photocell is obstructed. The gate resumed closing when the photocell is cleared. |
| 04 | DELAYED REVERSE. The gate stops if the photocell is obstructed. The gate opens when the photocell is cleared. |
| 55 01 | Photocell (FT2) mode with gate closed This parameter is not visible if AB 02 , AB 03 or AB 04 is set. |
| 00 | If the photocell is obstructed, the gate cannot open. |
| 01 | The gate opens when an open command is received, even if the photocell is obstructed. |
| 02 | The photocell sends the gate open command when obstructed. |
| 56 00 | Enable close command 6 s after activation of photocell (FT1-FT2) This parameter is not visible if AB03 or AB04 is set. NOTE: in the case of photocells being blanked during opening, the 6 secs. count starts when the wings are completely open. |
| 00 | Disabled. |
| 01 | Enabled. When the photocell barrier FT1 is crossed, a close command is sent 6 seconds later. |
| 02 | Enabled. When the photocell barrier FT2 is crossed, a close command is sent 6 seconds later. |

| | |
|--------------|--|
| 60 00 | Limit switch enabling |
| 00 | Limit switches disabled; programming the stroke and repositioning causes the sash to press on the mechanical stops, par. 25 and 26 adjust the stopping distance from these. |
| 01 | Limit switches enabled; stroke programming and repositioning are managed by the activation of the magnetic opening and closing limit switches. |
| 65 05 | Setting motor stop distance |
| 01-05 | 01= faster deceleration/shorter stop distance ... 05= slower deceleration/longer stop distance. |
| 71 01 | Selecting installation position of motor relative to gate (seen from interior side) N.B.: in the event of a reset to restore the default parameters, this parameter must be set again manually. |
| 00 | Motor installed on left. |
| 01 | Motor installed on right. |
| 73 00 | Configuring sensing edge COS1 |
| 00 | Sensing edge NOT INSTALLED. |
| 01 | NC contact (normally closed). The gate reverses only when opening. |
| 02 | Contact with 8k2 resistor. The gate reverses only when opening. |
| 03 | NC contact (normally closed). The gate always reverses. |
| 04 | Contact with 8k2 resistor. The gate always reverses. |
| 12 | Management of two 8k2 sensitive edges connected in parallel (total resistance 4k1). The gate reverses only when opening. |
| 14 | Management of two 8k2 sensitive edges connected in parallel (total resistance 4k1). The gate always reverses. |
| 74 00 | Configuring sensing edge COS2 |
| 00 | Sensing edge NOT INSTALLED. |
| 01 | NC contact (normally closed). The gate reverses only when closing. |
| 02 | Contact with 8k2 resistor. The gate reverses only when closing. |
| 03 | NC contact (normally closed). The gate always reverses. |
| 04 | Contact with 8k2 resistor. The gate always reverses. |
| 12 | Management of two 8k2 sensitive edges connected in parallel (total resistance 4k1). The gate reverses only when closing. |
| 14 | Management of two 8k2 sensitive edges connected in parallel (total resistance 4k1). The gate always reverses. |
| 76 00 | Configuring radio channel 1 (PR1) N.B.: With ROGER TECHNOLOGY plug-in radio receiver board. |
| 77 01 | Configuring radio channel 2 (PR2) N.B.: With ROGER TECHNOLOGY plug-in radio receiver board. |
| 00 | STEP MODE. |
| 01 | PARTIAL OPENING |
| 02 | OPENING |
| 03 | CLOSING. |
| 04 | STOP. |
| 05 | Courtesy light. The output COR is managed from the remote control. The light remains lit as long as the remote control is active. The parameter 79 is ignored. |
| 06 | Courtesy light in step mode (PP). The output COR is managed from the remote control. The remote control turns the courtesy light on and off. The parameter 79 is ignored. |
| 07 | STEP MODE with confirmation for safety. ⁽¹⁾ |
| 08 | PARTIAL OPENING with confirmation for safety. ⁽¹⁾ |
| 09 | OPENING with confirmation for safety. ⁽¹⁾ |
| 10 | CLOSURE with confirmation for safety. ⁽¹⁾ |

⁽¹⁾ To prevent gate manoeuvres caused by accidentally pressing a remote control button, confirmation is required to enable the command. Example: parameters 76 07 and 77 01 set:

- Pressing the CHA button on the remote control selects the step mode function, which must be confirmed within 2 seconds by pressing CHB on the remote control. Press CHB to activate partial opening.

| | |
|--------------|---|
| 78 00 | Configuring flashing light frequency |
| 00 | The frequency is set electronically from the flashing light unit. |
| 01 | Slow flash. |
| 02 | Light flashes slowly when gate opens, rapidly when gate closes. |

| | |
|--------------|--|
| 79 60 | Selecting courtesy light mode |
| 00 | Disabled. |
| 01 | PULSE. The courtesy light illuminates briefly at the start of each manoeuvre. |
| 02 | ACTIVE. The light remains lit for the entire duration of the manoeuvre. |
| 03-90 | From 3 to 90 s. The light remains lit for the time period set after the manoeuvre is completed. |
| 92-99 | From 2 to 9 minutes. The light remains lit for the time period set after the manoeuvre is completed. |

| | |
|--------------|--|
| 80 00 | Clock contact configuration When the clock function is active, the gate opens and remains open. At the end of the programmed time set with the external device (clock), the gate closes. |
| 00 | When the clock function is active, the gate opens and remains open. Any command signal received is ignored. |
| 01 | When the clock function is active, the gate opens and remains open. Any command signal received is accepted. When the gate returns to the completely open position, the clock function is reactivated. |

| | |
|--------------|--|
| 81 00 | Enable safeguarded gate closure/opening Enabling this parameter ensures that the gate is not left open due to an incorrect and/or accidental command. This function is NOT enabled if: <ul style="list-style-type: none"> the gate receives a STOP command; the sensitive edge intervenes, detecting an obstacle in the same direction in which the function is enabled. If instead the sensitive edge detects an obstacle during the movement opposite to the one guaranteed, the function remains active. the number of closure attempts set by parameter B2 has been reached; the acquired position is lost (perform position recovery, see chapter 20). |
| 00 | Disabled. The parameter B2 is not displayed. |
| 01 | Enabled. After a period of time set with parameter B2 , the control unit signals a 5 second warning with the flashing light, regardless of the parameter B5 , and then closes the gate. |
| 02 | Enabled. If the gate is closed as a result of a step mode command, after a period of time set with parameter B2 , the control unit signals a 5 second warning with the flashing light (regardless of the parameter B5), and then the gate closes. If the gate is stopped by the obstacle detection system during a closure manoeuvre, the gate closes after a period of time set with parameter B2 . If the gate is stopped by the obstacle detection system during an opening manoeuvre, the gate closes after a period of time set with parameter B2 . |

| | |
|--------------|--|
| 82 03 | Setting safeguarded closure/opening activation time N.B.: this parameter is not visible if the value of parameter B1 = 00. |
| 02-90 | Wait time settable from 2 to 90 s. |
| 92-99 | Wait time settable from 2 to 9 min. |

| | |
|--------------|---|
| 85 00 | Selection of the battery operation management Setting a value different than 00 a battery voltage level check is activated. The desired operation type can be selected via parameter B6 and an error alert can be activated through the COR output via parameter Z0 . |
| 00 | The control unit always accepts commands until the battery is completely exhausted. |
| 01 | The command becomes active when the battery voltage drops to the minimum threshold (22V $\overline{---$ with B71/BC charger; 24.2V $\overline{---$ with B71/PBX external charger) |
| 02 | The command becomes active when the battery voltage drops to the medium threshold (23V $\overline{---$ with B71/BC charger; 24.6V $\overline{---$ with B71/PBX external charger) |
| 03 | The command becomes active when the battery voltage drops to the maximum threshold (24V $\overline{---$ with B71/BC charger; 25.0V $\overline{---$ with B71/PBX external charger) |

| | |
|--------------|---|
| 86 00 | Selecting the battery operation limitations N.B.: the parameter is visible only if par. B5 is different than 00 |
| 00 | There is no limitation for the commands when the battery voltage drops under the selected threshold. An error alert may be activated via the COR output (if parameters B5 and Z0 are adequately set). |
| 01 | When the battery voltage drops under the threshold selected with par. B5 , the control unit accepts only opening commands and does not perform closing. |

| | |
|----|---|
| 02 | When the battery voltage drops under the threshold selected with par. 85, after a 5 s pre-flashing, the control unit automatically opens the barrier's boom and accepts only a closing command. |
| 03 | It accepts only closing commands even if the ORO input is active and if the parameter is 80 0 1. |
| 04 | When the battery voltage drops to the threshold selected with par. 85 the control unit, after a prelampping of 5s, automatically closes the gate and accepts only one opening command |

| | |
|------|--|
| 8700 | Selection of the battery type and consumption reduction NOTE: An INCORRECT setting of this parameter, when there is no mains voltage, blocks the functions and the display shows the message bLEL0 (if set to 0 1 or 02 and the battery is 2x12V \rightarrow) or an error alert b700d. |
| 00 | Battery 24V \rightarrow (2x12V \rightarrow) with B71/BCHP. Acceleration/deceleration/speed reduction enabled, to increase the battery life. |
| 01 | Battery 24V \rightarrow (2x12V \rightarrow) with external battery charger B71/PBX. Acceleration/deceleration/speed reduction enabled, to increase the battery life. |
| 02 | Battery 24V \rightarrow (2x12V \rightarrow) with external battery charger B71/PBX. No performance reduction, maximum battery consumption. |
| 03 | Battery 24V \rightarrow (2x12V \rightarrow) with external charger B71/PBX. No reduction in performance. Maximum battery consumption |

| | |
|-------|---|
| 90 00 | Restoring factory default values NOTE This procedure is only possible is NO data protection password is set. |
| | <p>Warning! Restoring default settings cancels all settings made previously except for parameter A 1, 7 1, 86, 87: after restore, check that all parameters are suitable for the installation.</p> <ul style="list-style-type: none"> Press and hold the PLUS + and MINUS - button until the unit switches on. The display flashes after 4 s rE5-. <p>The default factory settings have now been restored.</p> <p>Note: it is possible to reset the parameters in a second way: when the control unit is switched on, before the firmware version appears on the display, press and hold down the ▲ (UP ARROW) and ▼ (DOWN ARROW) buttons for 4s.</p> |

| | |
|-------|--|
| | Identification number The identification number consists of the values of the parameters from n0 to n5. N.B.: The values shown in the table are indicative only. |
| n0 01 | HW version. |
| n1 23 | Year of manufacture. |
| n2 45 | Week of manufacture. |
| n3 67 | |
| n4 89 | Serial number. |
| n5 01 | |
| n6 23 | FW version. |
| | Example: 0 1 23 45 67 89 0 1 23 |

| | |
|-------|---|
| | View manoeuvre counter The number consists of the values of the parameters from o7 to o 1 multiplied by 100. N.B.: The values shown in the table are indicative only. |
| o7 01 | |
| o0 23 | Manoeuvres performed. Example: 0 1 23 45 x100 = 1.234.500 manoeuvres. |
| o 145 | |

| | |
|-------|--|
| | View manoeuvre hour counter The number consists of the values of the parameters from h0 to h 1. N.B.: The values shown in the table are indicative only. |
| h0 01 | Manoeuvre hours. |
| h1 23 | Example: 0 1 23 = 123 hours. |

| | |
|-------|--|
| | View control unit days on counter The number consists of the values of the parameters from d0 to d 1. N.B.: The values shown in the table are indicative only. |
| d0 01 | Days with unit switched on. |
| d1 23 | Example: 0 1 23 = 123 days. |

| | |
|---|---|
| | <p>Password Setting a password prevents unauthorised persons from accessing the settings. With password protection active (CP=0 1), parameters may be viewed, but the values CANNOT be modified. Only a single password is used to control access to the gate automation system. WARNING: Contact the Technical Support Service if you lose your password.</p> |
| <p>P 1 00 P 2 00 P 3 00 P 4 00</p> | <p>Password activation procedure:</p> <ul style="list-style-type: none"> • Enter the desired values for parameters P 1, P2, P3 and P4. • Use the UP ▲ and/or DOWN ▼ buttons to view the parameter CP. • Press and hold the + and - buttons for 4 seconds. • The display flashes to confirm that the password has been saved. • Switch the control unit off and on again. Check that password protection is activated (CP=0 1). <p>Temporary unlock procedure:</p> <ul style="list-style-type: none"> • Enter the password. • Check that CP=00. <p>Password cancellation procedure:</p> <ul style="list-style-type: none"> • Enter the password (CP=00). • Save the values P 1, P2, P3, P4 = 00 • Use the UP ▲ and/or DOWN ▼ buttons to view the parameter CP. • Press and hold the + and - buttons for 4 seconds. • The display flashes to confirm that the password has been cancelled (the values P 1 00, P2 00, P3 00 and P4 00 indicate that no password is set). • Switch the control unit off and on again. |
| <p>CP 00</p> | <p>Changing password</p> |
| <p>00</p> | <p>Protection deactivated.</p> |
| <p>0 1</p> | <p>Protection activated.</p> |

13 Special parameters for High Speed series



The High Speed (**/HS**) series is a family of digital Brushless high speed sliding motor units for sliding gates weighing up to 600 kg (**TW90/600/HS**) and dedicated exclusively to residential applications. High Speed technology makes it possible for the automation system to operate 100% faster than a conventional system, and allows independent management of speed, acceleration, deceleration and the safety devices used in the system.

Note: As the mechanics of the gate is unknown, to guarantee the maximum safety of the installation, we recommended to use sensitive edges.

The additional parameters for enabling High Speed technology are indicated as follows.

| | |
|--------------|--|
| R102 | Selecting automation system model This parameter is factory configured by ROGER TECHNOLOGY. ATTENTION! The value of parameter <i>R1</i> is set at the factory to select the motor model (<i>D2</i> , see table below). If this value is incorrectly changed, the automation will not be able to work at full efficiency and malfunctions may occur. NOTE: in the case of resetting to the standard factory parameters, the value of the parameter is not changed. |
| <i>D1</i> | FW90/800- |
| <i>D2</i> | TW90/600/HS |
| <i>D3</i> | FW90/800/R- |
| 1104 | Setting deceleration during opening |
| 1204 | Setting deceleration during closing |
| <i>D1-D5</i> | <i>D1</i> = the gate decelerates near the mechanical stop/limit switch ... <i>D5</i> = the gate decelerates long before the mechanical stop/limit switch. |
| 3304 | Setting start acceleration during opening |
| 3404 | Setting start acceleration during closing |
| <i>D1-D5</i> | <i>D1</i> = the gate accelerates rapidly at start of manoeuvre ... <i>D5</i> = the gate accelerates slowly and progressively at start of manoeuvre. |
| 4008 | Setting opening speed N.B.: the speed setting range for the specific motor installed is automatically subdivided into 5 equal segments. |
| 4108 | Setting closure speed N.B.: the speed setting range for the specific motor installed is automatically subdivided into 5 equal segments. |
| <i>D1-D5</i> | <i>D1</i> = 6 m/min (minimum speed) ... <i>D5</i> = 26 m/min (maximum speed). |



N.B.: to set the constant speed deceleration space, see parameters **13** and **14** on chapter 12.

14 Special parameters for Reversible series



The Reversible (**/R**) series is a family of digital brushless motor units for sliding gates weighing up to 800 kg (**TW90/800/R**) and dedicated exclusively to residential and industrial applications.

REVERSIBLE technology makes it possible to open and close the gate without releasing the motor even in the event of power failure. When the gate is moved manually, in the absence of supply voltage, the rotation of the motor provides power to the control unit the display lights up and the message 'SELF' appears. **WARNING!** handle the gate by hand with moderation.

The control unit allows independent management of speed, acceleration, deceleration and the safety devices used in the system.

During normal operation (including operation under battery power), the control unit applies a sufficient braking force to impede manual movement of the gate.

As a result, prolonged operation may drain the battery when operating under battery power.

If the braking force applied is not sufficient to impede manual movement of the gate and a gate movement of more than 3 cm is detected, the control unit initiates a position recovery procedure (see chapter 20).

NOTE: Even though it is a REVERSIBLE unit, the motor is equipped with a lock release system.

The additional parameters for enabling REVERSIBLE technology are indicated as follows.

| | |
|-------------|---|
| A103 | Selecting automation system model This parameter is factory configured by ROGER TECHNOLOGY. ATTENTION! The value of parameter <i>A1</i> is set at the factory to select the motor model (03, see table below). If this value is incorrectly changed, the automation will not be able to work at full efficiency and malfunctions may occur. NOTE: in the case of resetting to the standard factory parameters, the value of the parameter is not changed. |
| 01 | FW90/800- |
| 02 | FW90/600/HS- |
| 03 | TW90/800/R |
| 1104 | Setting deceleration during opening |
| 1204 | Setting deceleration during closing |
| 01-05 | 01= the gate decelerates near the mechanical stop/limit switch ... 05= the gate decelerates long before the mechanical stop/limit switch. |
| 3304 | Setting start acceleration during opening |
| 3404 | Setting start acceleration during closing |
| 01-05 | 01= the gate accelerates rapidly at start of manoeuvre ... 05= the gate accelerates slowly and progressively at start of manoeuvre. |
| 4008 | Setting opening speed N.B.: the speed setting range for the specific motor installed is automatically subdivided into 5 equal segments. |
| 4108 | Setting closure speed N.B.: the speed setting range for the specific motor installed is automatically subdivided into 5 equal segments. |
| 01-05 | 01= 6 m/min (minimum speed) ... 05= 26 m/min (maximum speed). |



N.B.: to set the constant speed deceleration space, see parameters 13 and 14 on chapter 12.

15 Safety input and command status (TEST mode)

With no currently active commands, press the TEST button and check the following:

| DISPLAY | POSSIBLE CAUSE | ACTION BY SOFTWARE | PHYSICAL CORRECTIVE ACTION |
|------------------|---|--|--|
| BB 5b (00 Sb) | The release handle is open. | - | Close the release handle and turn the key to the close position. Check that the release contact is connected correctly. |
| BB 15 | The safety STOP contact is open. | - | Install a STOP button (NC) or jumper the ST contact with the COM contact. |
| BB 13 | Sensing edge COS1 not connected or incorrectly connected. | Set the parameter 73 00 if not used or to disable | Jumper contact COS1 with contact COM, if not used or to disable |
| BB 12 | Sensing edge COS2 not connected or incorrectly connected. | Set the parameter 74 00 if not used or to disable | Jumper contact COS2 with contact COM, if not used or to disable |
| BB 11 | Photocell FT1 not connected or incorrectly connected. | Set the parameter 50 00 e 51 00 if not used or to disable | Jumper contact FT1 with contact COM, if not used or to disable. Check connection referring to relative connection diagram. |
| BB 10 | Photocell FT2 not connected or incorrectly connected. | Set the parameter 53 00 e 54 00 if not used or to disable | Jumper contact FT2 with contact COM, if not used or to disable. Check connection referring to relative connection diagram. |
| BB FE | Both limit switches in open contact state or not connected. | - | Check connection of limit switches. In the absence of limit switches, check that par.50 is set to 00. |
| BB FA | Gate is at gate closed limit switch. | If the limit switch state indicated is incorrect, check the setting of parameter 71. | - |
| | Gate open limit switch absent or not connected. | - | Check connection of limit switches. In the absence of limit switches, check that par.50 is set to 00. |
| BB FC | Gate is at gate closed limit switch. | If the limit switch state indicated is incorrect, check the setting of parameter 71. | - |
| | Gate closed limit switch absent or not connected. | - | Check connection of limit switches. In the absence of limit switches, check that par.50 is set to 00. |
| PP 00 | If occurs with no voluntary command, the contact (N.O.) may be faulty or one of the buttons may be incorrectly connected. | - | Check PP - COM contacts and connections to buttons. |
| CH 00 | | - | Check CH - COM contacts and connections to buttons. |
| AP 00 | | - | Check AP - COM contacts and connections to buttons. |
| PE 00 | | - | Check PED - COM contacts and connections to buttons. |
| Or 00 | If occurs with no voluntary command, the contact (N.O.) may be faulty or the timer may be incorrectly connected. | - | Check ORO - COM contacts. Contact must not be jumpered if not used. |

N.B: press TEST to exit TEST mode.

We recommend troubleshooting safety device and input status errors with "corrective action by software" only.

16 Alarms and faults

| PROBLEM | ALARM | POSSIBLE CAUSE | ACTION |
|----------------------------------|--|--|--|
| The gate does not open or close. | POWER LED off | No power. | Check power cable. |
| | POWER LED off | Fuses blown. | Replace fuses. Always disconnect from mains power before removing fuses. |
| | <i>DF St</i> | Input mains power voltage fault. Control initialisation failed. | Disconnect from mains power, wait 10 seconds then reconnect to the mains and switch on. If the problem persists, contact your local authorized dealer for verification and possible assistance. Pressing the TEST button it is possible to hide the alarm temporarily and consult the control unit's parameters. |
| | <i>Pr Ot</i> | Overcurrent detected in inverter. | Press the TEST button twice or perform 3 command requests in succession. |
| | <i>dALtA</i> | Travel data acquisition error. | Check that open and closed limit switches are positioned correctly (if limit switches are enabled). Press TEST and check if any safety devices are in alarm state. Repeat acquisition procedure. |
| | | Calibration procedure failed. | Allow the indicated calibration times to elapse during self-acquisition. Before resetting the release pin, ensure that <i>PHAS</i> flashes in the display. Repeat acquisition procedure. |
| | <i>mot</i> | Motor not connected. | Check the motor cable. |
| | <i>FE</i> | Both limit switches activated. | Check connections of limit switches or check for foreign objects in limit switch blocks. Check if limit switches are absent that par.60 is set to 00. |
| | Example: <i>15 EE</i> <i>21 EE</i> | Configuration parameter error. | Set configuration value correctly and save. |
| | <i>EnE1</i> | Encoder not connected. | Check connection to encoder. Replacing the encoder is recommended if the problem persists. |
| | <i>EnE3</i> | Severe encoder malfunction. | Press TEST button. If the error code is displayed again, switch off the controller unit, wait 5 seconds and switch on again. Replace the encoder if the problem persists. |
| | <i>EnE5</i> (<i>EnE5</i>) | Encoder malfunction. | Press TEST button. Replace the encoder if the problem persists. |
| | | Insufficient power supply | If the unit contains dirt, moisture, insects or other foreign matter, disconnect from mains power and clean the board and the encoder. Replace the encoder if the problem persists. |
| | | Batteries functioning | The batteries are almost flat. |
| | <i>EnEB</i> | Encoder calculation error. | Repeat acquisition procedure. |
| | <i>tENP</i> | Inverter thermal overload circuit breaker tripped. | Function is restored automatically within 2 min. |
| | <i>SEnS</i> | Motor power control anomaly detected. | If the problem persists, replace the control unit. |
| | <i>btLO</i> (<i>btLO</i>) | Flat batteries. | Wait for mains power to be restored. |
| <i>StoP</i> flashing | Release device open. | Reset the release pin and check the connection to the release contact. | |
| <i>no PH</i> | Motor control anomaly detected | Repeat the acquisition procedure. If the problem persists, replace the control unit. | |

| PROBLEM | ALARM | POSSIBLE CAUSE | ACTION | |
|--|-------------------|---|---|--|
| The gate does not open or close. | <i>no PH</i> | Problems at the encoder circuit or at the connection cable. | Check the integrity of the connection cable. Disconnect and reconnect the power supply. Give a command (opening / step-by-step, ...). If <i>noPH</i> is NOT displayed, repeat the acquisition procedure. If <i>noPH</i> is displayed again, contact the technical service department. | |
| Acquisition procedure does not complete correctly. | <i>no PH</i> | Motor calibration failed. | Repeat acquisition procedure. If the problem persists, check the cable connecting the encoder to the motor. Check that the release pin has rotated. Check that the motor turns without impediment. Contact technical support in case of any problems. Check that the mains voltage is correct and that the mains cable cross-section is adequate. | |
| | | <i>AP PE</i> | TEST button pressed accidentally. | Repeat acquisition procedure. |
| | | | Safety devices in alarm state. | Press the TEST button and check the safety device/s in alarm state and the connections of the safety devices. |
| | <i>AP PL</i> | Excessive voltage drop. | Repeat acquisition procedure. Check mains voltage. | |
| | | Incorrect setting of parameters $\exists 0$ and $\exists 1$. | Adjust parameters $\exists 0$ and $\exists 1$ correctly for the weight and speed of the gate leaf. | |
| | <i>APP L</i> | Travel length error. | Move gate into completely closed position (the signalling of the limit switch FC if limit switches enabled par.60, must be active) and repeat the procedure. Check cable of limit switches (if installed and enabled on par.60). Replace the cable if the problem persists. Reset default controller unit parameters and repeat the procedure. Stroke length less than the minimum allowed: increase the length. | |
| | | | Maximum permitted travel length exceeded | Reduce the ride. Contact technical assistance (travel exceeding the maximum allowed by the technical characteristics). |
| Remote control has limited range and does not work while automated gate is moving. | - | The radio transmission is impeded by metal structures and reinforced concrete walls. | Install the antenna outside. | |
| | - | Flat batteries. | Replace the transmitter batteries. | |
| The flashing light is not working. | - | Bulb / LED blown or flashing light wires disconnected. | Check LED circuit and/or connector wires. | |
| Gate open indicator lamp does not work. | - | Bulb blown or wires disconnected. | Check the bulb and/or wires. | |
| Gate does not perform desired manoeuvre. | - | Incorrect setting of parameter $\exists 1$. | Select the correct installation position with parameter $\exists 1$. | |
| The control unit is switched off and does not start. | - | F2 fuse blown due to overvoltage. | Replace the 2A F2 fuse. | |
| | <i>SELF</i> | Only for TW90/800/R. The gate is moved by hand without being unlocked, without mains and/or battery voltage | WARNING: if B71/BC is used, check the correct connection of the battery charger to the control unit (the red cable [+] must be connected to the POWER IN terminal 5, the black cable [-] must be connected to the POWER IN terminal 4). Otherwise, the manual manoeuvre will not be performed correctly. | |
| The control unit does not accept commands. | <i>SELF ALI L</i> | Incorrect connection of the battery charger to the control unit. After 5 s the display shows ALIM to confirm the incorrect connection of the POWER-IN terminal strip. | Reverse the connection of the (+) and (-) wires on the POWER IN terminal strip of the control unit (see battery connection at fig. 2) By pressing the TEST button, the error can be temporarily hidden to consult the control unit parameters. | |

N.B.: Press the TEST button to temporarily cancel the alarm.

The next time a command is received, the alarm reappears on the display if the problem has not been resolved.

17 Procedural verifications - INFO Mode

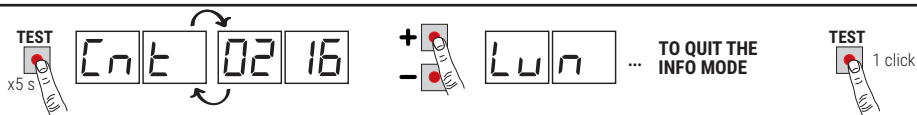

INFO mode may be used to view certain parameters measured by the **B70/1T** controller. Press and hold the TEST button for 5 seconds from the "View command signals and safety devices" mode with the motor stationary.

The control unit displays the following parameters and the corresponding measured values in sequence:

| Parameter | Function |
|---------------|---|
| <i>r 1.00</i> | View for 3 s the firmware version of the control unit. |
| <i>Cnt</i> | Displays the position of MOTOR, expressed in revolutions and relative to total length, at the time of the test. (example: <i>0 113</i> = motor installed on the left <i>7 1 00</i> ; <i>0 113</i> = motor installed on the right <i>7 1 0 1</i>). |
| <i>Lun</i> | View total length of programmed travel of MOTOR, in motor revolutions. |
| <i>rPN</i> | View motor speed of MOTOR, in revolutions per minute (rPM). |
| <i>ANP</i> | View current absorption of motor, in Amperes (e.g.: 001.1 = 1,1 A ... 016.5 = 16,5 A). If the MOTOR is stationary, the current absorption value is 0. Activate a command function to test current absorption. |
| <i>bUS</i> | System OK indicator. To check for overloading (e.g.: too many utilities connected to 24 V output) or if the mains voltage is too low, compare the parameters read with values indicated as follows with the motor stationary: mains voltage = 230 V~ (nominal), bUS= 28.5 mains voltage = 207 V~ (-10%), bUS= 25.5 mains voltage = 253 V~ (+10%), bUS= 31.6 |
| <i>CNP</i> | Display current, expressed in Amperes, used to compensate for strain detected by MOTOR due, for example, to low external temperatures (e.g.: 0 = 0 A ... 4 = +6 A). At the beginning of a manoeuvre from the completely open or completely closed position, if the control unit detects a strain higher than the value stored in its memory during the travel acquisition cycle, the controller automatically increases the current delivered to MOTOR. |
| <i>RSC</i> | Display current threshold, expressed in Amperes, at which the obstacle detection function (crush prevention) of MOTOR is triggered. This value is calculated automatically by the controller in relation to the settings of parameters <i>30</i> and <i>31</i> . For the motor to function correctly, <i>ANP</i> must always be lower than the value <i>RSC</i> . |
| <i>tIn</i> | Indicates time taken by MOTOR to detect an obstacle, as set with parameter <i>31</i> , in seconds. E.g. <i>1.000</i> = 1 s / <i>0.120</i> = 0.12 s (120 ms). Ensure that the manoeuvre time is more than 0.3 s. |
| <i>UP</i> | If the control unit is capable of identifying the position of the gate when the test is conducted, the following is shown on the display: <i>UP _</i> position known, normal operation. <i>UP L</i> position unknown, position recovery in progress. |
| <i>DC</i> | Indicates the state of the automation system (open/closed). <i>DC 0P</i> automation system opening (motor active). <i>DC CL</i> automation system closing (motor active). <i>DC -0</i> automation system completely open (motor not actives). <i>DC -C</i> automation system completely closed (motor not actives). |
| <i>UF</i> | <i>UF U_</i> mains voltage too low or overload. <i>UF _H</i> motors overcurrent. |
| <i>nPTE</i> | Displays the number of thermal protection interventions of the inverter. If it displays a number different from 0000, check that there are no excessive stress points and if the leaf, coming onto mechanical stops, does not activate the limit switch. Check the settings of parameters <i>30</i> and <i>31</i> . |
| <i>Hibu</i> | Displays information about the electronic voltage limiter (ROGER TECHNOLOGY's TECHNICAL ASSISTANCE ONLY). |

- Use the + / - buttons to scroll through the parameters. When the last parameter in the sequence is reached, press the - button to return through the previous parameters.
- In INFO mode, the automation system may be activated to test operation in real time.
- Press and hold the TEST button for a few seconds to exit INFO mode.

17.1 B74/BCONNECT mode

By inserting **B74/BCONNECT** in the **WiFi** connector, all the functions are managed through internet browser and devices such as smartphones, tablets, PCs, exploiting WiFi communication, tablet, PC, all the functionalities of the central unit are managed, using the WiFi communication.



For further information consult the installation manual of the connection module **B74/BCONNECT** connection module.

“Remote assistance” mode

Allows access and therefore the management of all the data of the control unit only in cloud mode and therefore with remote management.

When remote assistance is enabled, the message **ASCC** (assistance connect controlled) appears on the display.

By pressing the **TEST** button this message disappears for 10 seconds, and it is possible to access the parameters and other functions of the display.

After 30 minutes the display goes into stand-by, if the display is awakened by pressing a key the flashing **ASCC** reappears.

“Emergency operation” mode

This mode is used to exclude motor and safety alarms (e.g. photocells and sensitive edges), allowing the automation to open and close at low speed and with the operator present, with movement of the leaves only in the presence of a persistent command (when the command is released, the leaves stop).

Emergency operation is indicated by activation of the flashing light at a higher frequency.

Two types of “emergency” mode are possible: residential or condominium.

1) **residential** (flashing **L-ES** display indication): the PP command (from the terminal board or radio control) is initially managed as an opening command; only when complete opening has been reached will activation of the command send it to closing. Only when complete closure has been achieved will the command be able to open again.

2) **condominium** (flashing **L-EM** display indication): the PP command is initially managed as an opening command, but once it has been fully opened the leaves no longer close.

In this mode the display stand-by is not activated, always indicating the mode in progress.

By pressing the **TEST** button this message disappears for 10 seconds, and it is possible to access the parameters and other functions of the display.

| | |
|-------------|--|
| ASCC | "Remote assistance" mode enabled |
| L-ES | "Residential emergency operation" mode enabled |
| L-EM | "Condominium emergency operation" mode enabled |

18 Operation without limit switches

If magnetic limit switches are not installed (par. 50 00, limit switches disabled), the stroke programming or position recovery procedure causes the sash to press against the mechanical stops.

Once the procedure has been completed, the sash moves back by the number of revolutions set by parameters 25 and 26, and in subsequent manoeuvres the sash always stops ahead of the mechanical stops.

Attention! Ensure that the value of par.23 is always less than or at most equal to par.25; the same applies to par.24 with respect to par.26

19 Mechanical release

In the event of a fault or mains power loss, the gate may be released and opened manually. For systems with TW90/800/R the gate can be moved by hand without unlocking it.

If the gate releases with the controller unit powered, the message 5E0P flashes on the display.



For further information, refer to the locking/release operation in the manual of the automation system **TW90**.

When the release system is restored to the normal operating position, if the gate is not completely open or completely closed (by activating the corresponding limit switch, if installed and enabled, 500 I) or if limit switches are not installed (5000), the control initiates a position recovery procedure (see chapter 20).

20 Position recovery mode

After a mains power outage or after mechanically releasing the gate, if the gate is not completely open or completely closed the next time a command is received (not activating one of the two limit switches, if installed and enabled), the control initiates a position recovery procedure:

- The gate starts a low speed manoeuvre.
- The flashing light flashes with a different duty cycle than normal (3 s on, 1.5 s off).
- The control unit recovers the installation data during this procedure. **Warning!** During this procedure, do not use any controls until it is completed.

In the presence of limit switches (500 I)

- If the gate leaf is in the fully open or fully closed position, the position recovery procedure is as follows: the gate clears the limit switch, stops briefly and resumes operation at the speed set in parameters 40 and/or 4 I. Arrival

at the opposite limit switch takes place at the reduced speed set automatically (irrespective of the settings of parameters 13, 14 and 42), recovering position control with maximum precision.

- If, on the other hand, the leaf is in an intermediate position, it runs at reduced speed and the activation of one of the two limit switches allows immediate recovery of the position.

Without limit switch (50 00)

The execution of a complete stroke, from one mechanical stop to the other, allows the position to be recovered. The leaf retracts by the number of revolutions chosen in paragraphs 25, 26.

- Only for **TW90/800/R** motor. If the control unit detects a manual movement of more than 3 cm from the initial position, it launches a movement command that returns the sash to the position.

21 Initial testing



The testing must be performed by qualified technical personnel.

The installer is required to measure impact forces and select on the control unit the appropriate speed and torque values to ensure that the motorised door or gate remains within the limits defined by the standards EN 12453 and EN 12445.

Make sure that the provisions in Chapter 1 "GENERIC WARNINGS are observed.

- Turn on the power supply.
- Check that all connected controls are working correctly.
- Check that the release pin works correctly. The message **5EOP** must flash on the display.
- Check travel and deceleration.
- Check that the impact force is correct, in compliance with EN 12453 and EN12445.
- Check that the safety devices are activated correctly.
- If the battery kit is installed, disconnect from mains and check that the batteries are working.
- Disconnect from mains power and disconnect the batteries (if used), then reconnect. Starting with the gate stopped in an intermediate position, check that the position recovery procedure is completed correctly for both the open and closed positions.
- Check that the limit switches are set correctly and function correctly (if installed). If necessary, change the setting of the parameter determining the motor position (right, left).
- Check that there is a gap of at least 2-3 cm between the gate and the mechanical stop at the end of the manoeuvre.
- **Only for TW90/800/R.** Check that without mains or battery voltage, when moving the leaf by hand, the control unit is switched on and that the display shows the "SELF" message.
- **Only for TW90/800/R.** If there are batteries, disconnect the mains power and check that the display shows **BATE**. If **SELF** is displayed followed by **ALIT**, change the red and black cables connection to the POWER-IN terminal strips, as indicated in fig 2.

22 Start-up

The installer is required to draw up and preserve the technical file of the system for at least 10 years, which must contain the wiring diagram, the drawing and the photo of the system, the risk analysis and the solutions adopted, the manufacturer's declaration of conformity for all connected devices, the instructions manual of each device and / or accessory and the system's maintenance plan.

Apply a plate indicating the automation system data on the motorised door or gate, the name of the person in charge of the start-up, the serial number and the year of construction, as well as the CE mark.

Apply a plate and / or label with the indications for the operations required to manually unlock the system.

Draw up and provide the end user with the declaration of conformity, instructions and warnings for use and the maintenance plan.

Make sure that the end user has understood the correct automatic, manual or emergency operation of the system.

Inform the end user about the dangers and risks that may be present.

23 Maintenance

Perform scheduled maintenance every 6 months.

Check cleanliness and function.

If the unit contains dirt, moisture, insects or other foreign matter, disconnect from mains power and clean the board and the housing.

Repeat the initial installation test procedure after cleaning.

If any corrosion is found on the printed circuit board, evaluate if it is necessary to replace the board itself.

Check that the battery is in good working order.

24 Disposal



This product may only be uninstalled by qualified technical personnel, following suitable procedures for removing the product correctly and safely. This product consists of numerous different materials. Some of these materials may be recycled, while others must be disposed of correctly at the specific recycling or waste management facilities indicated by local legislation applicable for this category of product. Do not dispose of this product as domestic refuse. Observe local legislation for differentiated refuse collection, or hand the product over to the vendor when purchasing an equivalent new product.

Local legislation may envisage severe fines for the incorrect disposal of this product.

Warning! Some parts of this product may contain substances that are harmful to the environment or dangerous and which may cause damage to the environment or health risks if disposed of incorrectly.

25 Additional information and contact details

ROGER TECHNOLOGY is the exclusive proprietor holder of all rights regarding this publication. ROGER TECHNOLOGY reserves the right to implement any modifications without prior notification. Copying, scanning or any alterations to this document are prohibited without express prior authorised from by ROGER TECHNOLOGY.

ROGER TECHNOLOGY CUSTOMER SERVICE:

business hours: Monday to Friday
08:00 to 12:00 - 13:30 to 17:30
Telephone no: +39 041 5937023
E-mail: service@rogertechnology.it
Skype: service_rogertechnology

Declaration CE of Conformity

The undersigned Dino Florian, legal representative of **Roger Technology - Via Botticelli 8, 31021 Mogliano V.to (TV)** DECLARES that the **B70/1T** digital control unit is compliant with the provisions established by Community directives:

- 2014/35/UE LVD Standard
- 2014/30/UE EMC Standard
- 2014/53/UE RED Standard
- 2011/65/UE RoHS Standard

and that all the standards and/or technical requirements indicated as follows have been applied:

EN 61000-6-3
EN IEC 61000-6-2
EN 60335-1

Place: Mogliano V.to

Date: 03/06/2023

Signature



ROGER TECHNOLOGY
Via S. Botticelli 8 • 31021 Bonisiolo di Mogliano Veneto (TV) • ITALIA
P.IVA 01612340263 • Tel. +39 041.5937023 • Fax. +39 041.5937024
info@rogertechnology.com • www.rogertechnology.com