

BR21 SERIES

TODAY'S DIGITAL INTELLIGENCE
MOVES YOUR GATE



WHAT WE DO

INNOVATION, TOP NOTCH MECHANICS AND NEVER-ENDING TECHNOLOGICAL RESEARCH ARE THE ELEMENTS THAT MAKE ROGER TECHNOLOGY A UNIQUE AND DIFFERENT COMPANY

Starting from our first day of work we immediately gave priority to the development and production of excellent, completely Italian mechanics, based only on top quality ferrous and non ferrous raw materials and guaranteed by impeccable production and surface treatment processes. It was just a few years later, starting in the 1990s, that we created the first major step in our history, by implementing a real mass production line for completely robotised motors, thus becoming a reference outsourcer for major brands of the gate automation market.

PEOPLE, IDEAS AND PRODUCT EXPERIENCE

From the very beginning Roger Technology has evolved and grown because it's people believe that any bright idea can lead to great change in the future. Our people are passionate and innovative in our approach to every challenge, allways pushing the boundaries to develop extraordinary products.

In our language we translate the word "experience" as passion. It is this passion that drives us in the development of revolutionary **new products** that serve the real needs of our customers. We understand that our customers want a product designed around the way that they work.

*Primo Florian
Founding partner
Engineering
and design*

*Dino Florian
Founding President
Development
and design*

*Renato Florian
Founding partner
Assembly
and quality*



OUR PLUSES

EXCELLENT RAW MATERIALS

Steel, ductile cast iron, aluminium, bronze, copper and titanium have always been the main and exclusive raw materials used in the advanced engineering processes of our company.



PRODUCTION TECHNOLOGY

At Roger Technology all internal manufacturing is carried out on optimised production lines making use of very advanced technology. We have invested heavily in robotics and automated all product manufacturing phases. This ensures that all components and semi-finished products are highly reliable and are fully compliant with our exceptionally high quality standards.



INTERNAL ASSEMBLY

Our highly qualified and dedicated staff oversee the fitting and assembly stages. Every piece of equipment is checked by our all italian personnel to ensure that we deliver reliable products to our customers.



MADE IN ITALY

All solutions, products, design and the complete production process of Roger Technology is developed in Italy with the use of materials of primary quality always found in the market trough partner suppliers that share the same passion and professionalism of our company in developing products technologically reliable, efficient and simple in the way that they have been made for being installed and used.



BRUSHLESS MOTOR

A DIGITAL BRUSHLESS MOTOR WITH PERMANENT MAGNETIC FIELD, DIGITAL ELECTRONICS FOR THE COMPLETE MANAGEMENT OF THE AUTOMATION SYSTEM CONTROL. DESIGNED FOR SUPER INTENSIVE USE WITH THE ADDED BENEFIT OF A SUPER LOW POWER CONSUMPTION: THIS IS ROGER BRUSHLESS

We are the creators at the heart of the product!
All of our digital brushless motors are designed and manufactured in our own factories. Using dedicated automated machines the motors are wound with ultimate precision.

DIGITAL BRUSHLESS MOTOR

Revolutionary and innovative digital Brushless motor with permanent magnetic field, three-phase sinusoidal power supply with native encoder that allows super-intensive use of the automation system with extremely low power consumption, not only providing 100% compliance with all the automation system management and safety rules, but setting new standards in gate safety.

NEW GENERATION OF ELECTRONICS

The new control unit with onboard digital Brushless controller. Without traditional relays and due to the revolutionary MOSFET quadrant system and its control technology entirely based on a DSP (Digital Signal Processor) microcontroller, it represents a new generation of electronic cards created to safely handle all movement phases of the automation system.

ENGINEERING PASSION

All the mechanical components and gears are manufactured in steel, cast iron and bronze. The automation system casings are made from titanium-reinforced die-cast aluminium. All the gears are inspected and assembled on high-quality bearings and inserted on precise seats machined to provide absolute precision between the axes.

**A TECHNOLOGY THAT OFFERS MAXIMUM PERFORMANCE
BUT CONSUMES LESS POWER THAN OTHER MOTORS**

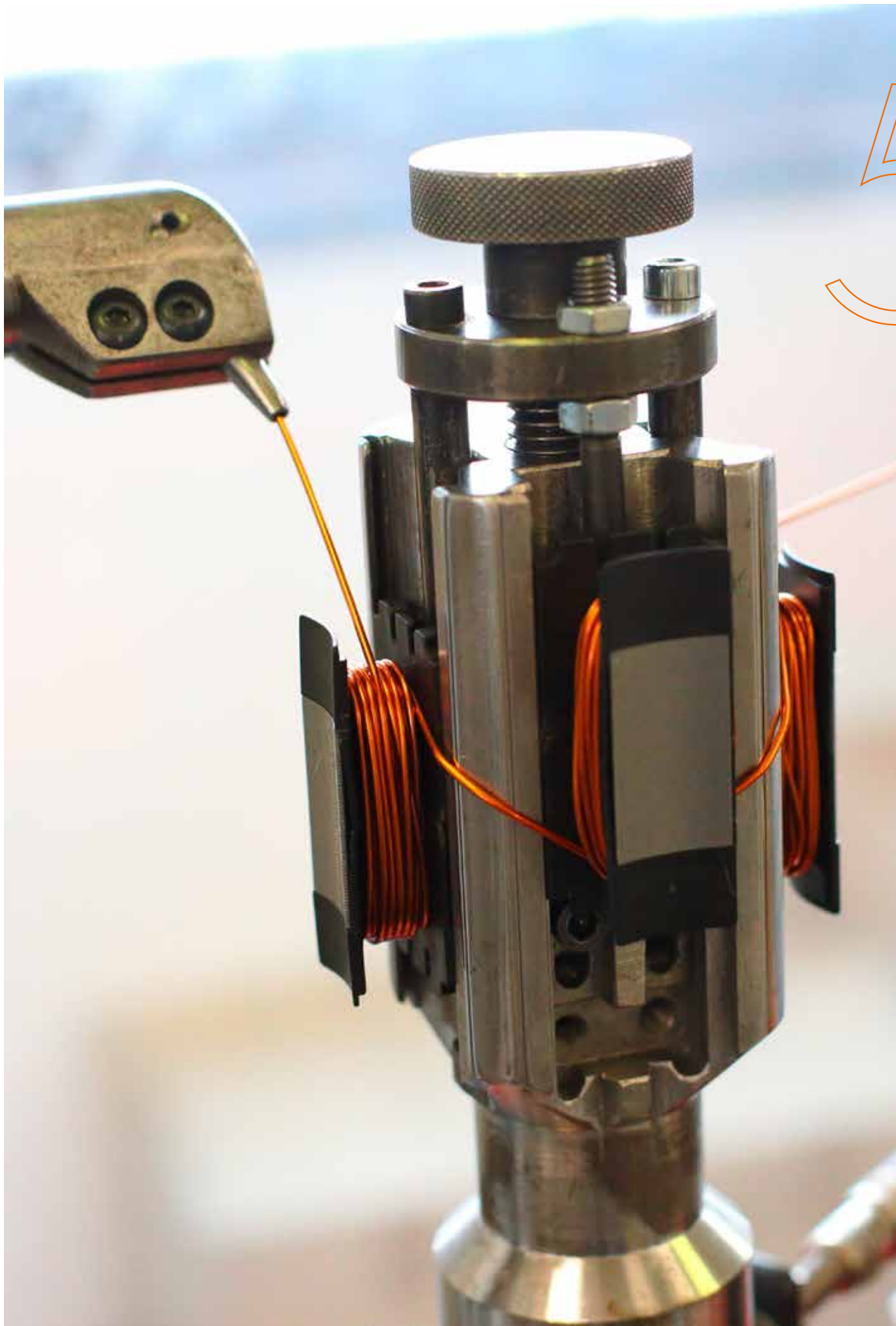

5

COMPLETELY BRUSHLESS

THE REVOLUTIONARY DIGITAL MOTOR WITH 12 UNIQUE FEATURES



3-PHASE DIGITAL BRUSHLESS MOTOR

A very powerful motor with substantial torque. The motor is compact and neat due to the special concentrated coil windings, it is powered by a **three phase sinusoidal system**.



NO PROBLEM IN THE EVENT OF POWER FAILURE

With the help of internal or external batteries and the associated battery charging card, your automation system continues to operate for a considerable time **even during prolonged power cuts**, ensuring many more operations than traditional technologies.



SPEED, ACCELERATION AND DECELERATION WITH EXTREME ELEGANCE

The automation system with brushless digital technology creates perfect and elegant movements. With a constant **force and torque** at every point and with the option of varying the speed on deceleration and acceleration the system can be managed with maximum safety.



EXTREMELY LOW ENERGY CONSUMPTION

A motor that can operate at low voltage in super-intensive use and which can operate in environments with extremely demanding weather conditions while maintaining **very low energy consumption and absorption levels**. We can open a swing gate with two leaves of 2.5mt length for each single leaf, using a maximum of 40W of power.



DIGITAL AND VECTORIAL AUTOMATION CONTROLLER

The BRUSHLESS digital controller, which operates at low voltage **36V DC**, allows 100% control of the automation system in digital mode. Due to its operation entirely based on a DSP microcontroller the travel and all the movements of your automation system can therefore be programmed and customised easily, precisely and elegantly.



MOTOR AT AMBIENT TEMPERATURE

The brushless motor was created with the main goal of being a motor for super intensive use and **with a 99% efficiency**. Regardless of how many operations the engine performs in a day, it always remains cold or at the most reaches the outside ambient temperature.

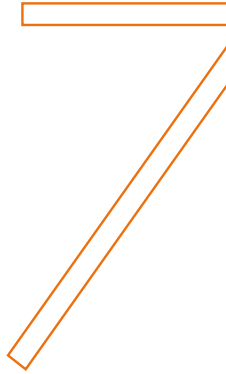

THE DIGITAL SILENCE OF THE MOTOR

One great impact is the **silence** or the near absence of noise, generated by the BRUSHLESS motor during all its movements.



MOTOR FOR SUPER-INTENSIVE USE

We wanted to surprise our customers with a product that was fundamentally different to any other product on the market. Fact: our motor remains **permanently cold** even after many days of super intensive use.



IMPACT, OBSTACLE DETECTION AND REVERSAL IN TOTAL SAFETY

Thanks to digital technology we are able to **detect an obstacle** and reverse the motor instantly, by simply specifying the torque of the motor, the sensitivity, the time and the travel of the reversal. All in full compliance with safety requirements.



ONBOARD NATIVE DIGITAL ENCODER

The BRUSHLESS motor has a highly advanced **native digital encoder** that controls management of automation systems in a safe, precise and extremely elegant manner.



SIMPLE INSTALLATION WITH A SINGLE 3-WIRE CABLE

The BRUSHLESS motor can be installed by simply connecting it using three wires! What could be easier? This will provide full digital management of your automation system thanks to the **SENSELESS** and **SENSORED** (absolute encoder) technology incorporated in the BRUSHLESS sliding gate motors.



ADVANCED PRECISION ENGINEERING TO OBTAIN OPTIMAL MOTOR PERFORMANCE

We have created a mechanism that gives you the opportunity to get **the maximum performance out of the motor**. A product which combines the quality of the internal production processes, the mechanical processing and the use of high quality ferrous and non-ferrous materials.

WHY BRUSHLESS?

DIGITAL, SMART, POWERFUL, ELEGANT, ROBUST AND ALL-ITALIAN

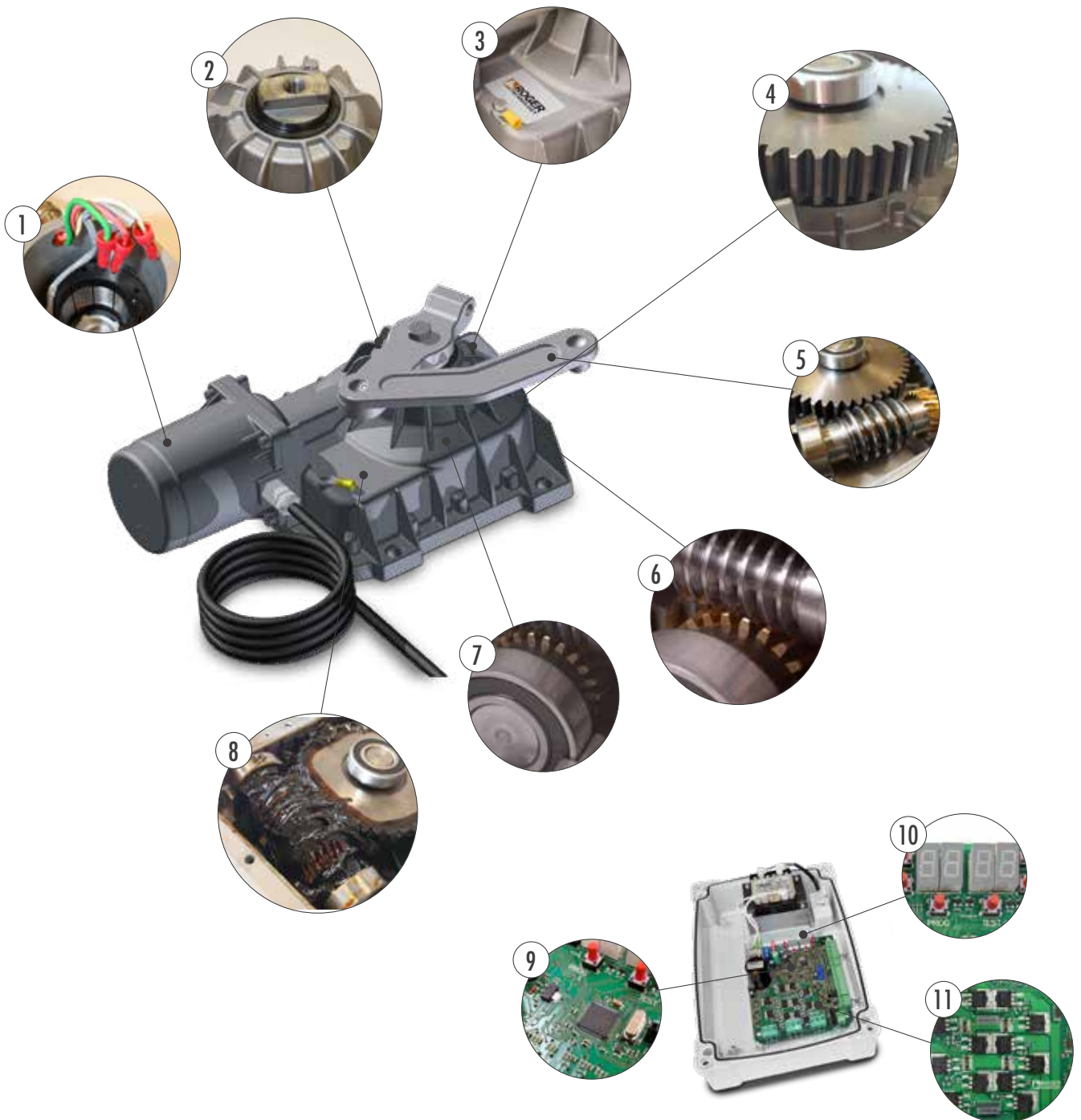

1 CABLE GROMMET WITH DUAL LAYER EPOXY RESIN SEAL

Innovative three phase technology makes it possible to connect the in-ground brushless motors to the digital controller with a single 3-core cable. All cable grommets and nickel plated brass connector junctions are protected by dual layer epoxy resin seals.

2 DOUBLE LIP OIL SEAL WITH DUST SEAL

A dual lip oil seal is installed on the top end of the reduction gear unit idle shaft, ensuring complete protection against contamination caused by from external factors such as water, dust or mud, which would compromise the efficiency of the drive unit.

3 EXTREMELY ROBUST, REINFORCED ALUMINIUM HOUSING

The housing of the Brushless BR21 in-ground motor is constructed entirely in die-cast titanium reinforced aluminium. The thicknesses are increased and reinforced in the areas of greatest stress or possible wear. The housing is protected against the weather with a special epoxy powder coat treatment, while all fastener hardware is in stainless steel.

4 MAIN GEAR IN CAST IRON

The main gear is manufactured completely from spheroidal graphite cast iron. The thickness and diameter of the gear are oversized to create an extremely robust component with superior resistance to mechanical strain and failure.

5 EXTREMELY DURABLE WORM SCREW

The idle shaft drive worm screw is manufactured in steel. The threaded part of the screw is not cut with machine tools but realised with a billet rolling process, to ensure superior durability and extremely quiet operation.

6 PRECISE, SILENT MECHANICAL CONNECTIONS

All mechanical connections between the drive shaft and the mechanical gears of the reduction unit are in ferrous and non-ferrous metals; with cast iron, carbon steel and bronze/aluminium used in particular. All mechanical connections are extremely precise, as they are realised with highly accurate processes, ensuring the quietness and superior durability of the reduction unit.

7 DEDICATED HIGH EFFICIENCY BEARINGS

All the bearings using for the motor shaft and in the reduction gear transmission unit are housed on specifically machined seats. The in-ground drive unit is fitted with class 2 ZZ bearings. These are high efficiency components designed for high rotation speeds, with extremely low mechanical friction and protected by dual steel shielding.

8 HIGH EFFICIENCY LUBRICATION

The in-ground drive unit is lubricated with a generous quantity of extremely high performance grease to keep it operating with superior mechanical efficiency. This lithium soap based grease is capable of withstanding the most intense mechanical usage and maintains its physical properties even in extreme heat and cold, effectively minimising friction and preventing increased power absorption over a wide range of temperatures.

9 MICRO-CONTROLLER WITH DSP SENSORLESS TECHNOLOGY

The digital controller controls the brushless motor via a single 3 core cable, managing your automation system entirely digitally with SENSORLESS motor power control technology.

10 MULTIFUNCTION DIGITAL DISPLAY













4-quadrant digital display with 6 function keys for navigating through different parameters, changing their values, checking error messages and input statuses and performing all self-acquisition cycles.

11 4 QUADRANT MOSFET DIGITAL INVERTER

The digital controller of the three-phase sinusoidal brushless motor with field oriented control uses an extremely potent and revolutionary 12 Mosfet, 4 quadrant sinusoidal control digital inverter to control motor power with vector frequency modulation.



TECHNICAL SPECIFICATIONS

	BR21/351	BR21/351/HS	BR21/361	BR21/361/HS	BR21/362
DESCRIPTION	Electromechanical underground motor, BRUSHLESS, low voltage, super intensive use, with native encoder onboard, irreversible, ideal for swing gates with leaf up to 4,5 mt. Standard version with 2 mt cable.	Electromechanical underground motor, BRUSHLESS HIGH SPEED, low voltage, super intensive use, with native encoder onboard, irreversible, ideal for swing gates with leaf up to 3 mt. Standard version with 2 mt cable.	Electromechanical underground motor, BRUSHLESS, low voltage, super intensive use, with native encoder onboard, irreversible, ideal for swing gates with leaf up to 4,5 mt. Standard version with 10 mt cable.	Electromechanical underground motor, BRUSHLESS HIGH SPEED, low voltage, super intensive use, with native encoder onboard, irreversible, ideal for swing gates with leaf up to 3 mt. Standard version with 10 mt cable.	Electromechanical underground motor, BRUSHLESS, low voltage, super intensive use, with native encoder onboard, irreversible, ideal for swing gates with leaf up to 5 mt. Double bearings version with 10 mt cable.
		 		 	
POWER LINE SUPPLY	230V AC - 50Hz	230V AC - 50Hz	230V AC - 50Hz	230V AC - 50Hz	230V AC - 50Hz
MOTOR POWER SUPPLY	24V	24V	24V	24V	24V
POWER RATING	200W	200W	200W	200W	200W
FREQUENCY OF USE	Intensive use 	Intensive use 	Intensive use 	Intensive use 	Intensive use 
TORQUE	50 - 300 N m	50 - 200 N m	50 - 300 N m	50 - 200 N m	50 - 300 N m
OPERATING TEMPERATURE	-20+55°C	-20+55°C	-20+55°C	-20+55°C	-20+55°C
PROTECTION LEVEL	IP67	IP67	IP67	IP67	IP67
REDUCTOR TYPE	Irreversible	Irreversible	Irreversible	Irreversible	Irreversible
MANOEUVRE SPEED	1,2 Rpm	2 Rpm	1,2 Rpm	2 Rpm	1,2 Rpm
OPENING TIME AT 90°	19-29 s	10-25 s	19-29 s	10-25 s	19-29 s
LIMIT SWITCH	Mechanical stoppers	Mechanical stoppers	Mechanical stoppers	Mechanical stoppers	Mechanical stoppers
RECOMMENDED DIGITAL CONTROLLERS	230V: EDGE1/BOX - 115V: EDGE1/BOX/115	230V: EDGE1/BOX - 115V: EDGE1/BOX/115	230V: EDGE1/BOX - 115V: EDGE1/BOX/115	230V: EDGE1/BOX - 115V: EDGE1/BOX/115	230V: EDGE1/BOX - 115V: EDGE1/BOX/115
ENCODER	Digital native encoder SENSORLESS 48 PPR	Digital native encoder SENSORLESS 48 PPR	Digital native encoder SENSORLESS 48 PPR	Digital native encoder SENSORLESS 48 PPR	Digital native encoder SENSORLESS 48 PPR
MAXIMUM OPENING	105°(optional 125° - 360°)	105°(optional 125° - 360°)	105°(optional 125° - 360°)	105°(optional 125° - 360°)	105°(optional 125° - 360°)
POWER SUPPLY CABLE LENGTH	2m	2m	10m	10m	10m
BEARING ON MAIN SHAFT	Standard	Standard	Standard	Standard	Double bearings
OPERATING CYCLES PER DAY (OPENING/CLOSING - 24 HOURS NO STOP)	1300	1300	1300	1300	1300
MAXIMUM DIMENSION PRODUCT IN MM (L X W X H)	345 x 224 x 144	345 x 224 x 144	345 x 224 x 144	345 x 224 x 144	345 x 224 x 144
PRODUCT WEIGHT PACKED (KG)	12,8	12,8	15,3	12,8	15,8



Brushless Motor



Intensive Use



High Speed Motor



Reversible Motor



PACKAGING

L.: 40 cm
W.: 24 cm
H. 16 cm

FUNCTIONS

OF AUTOMATED SLIDING GATE MOTOR

DESCRIPTION	BR21/351 - BR21/361 BR21/351/HS - BR21/361/HS	BR21/362
MAXIMUM LENGTH OF SINGLE GATE LEAF	UP TO 4.5 METRES PER SINGLE LEAF	UP TO 5 METRES PER SINGLE LEAF
DIGITAL CONTROLLER	EDGE1/BOX, 36V DC (BR21/351/HS since version P3.20)	EDGE1/BOX, 36V DC
RADIO RECEIVER TYPE	H93/RX20/I with fixed code connection H93/RX22A/I with fixed code connection H93/RX2RC/I with rolling code connection	H93/RX20/I with fixed code connection H93/RX22A/I with fixed code connection H93/RX2RC/I with rolling code connection
MOTOR POWER SUPPLY	36V DC with self-protected inverter	36V DC with self-protected inverter
MOTOR POWER CONTROL TECHNOLOGY (ETPC)	Field oriented control (FOC) with SENSORLESS technology	Field oriented control (FOC) with SENSORLESS technology
ENCODER TYPE	Digital SENSORLESS, 48 PPR	Digital SENSORLESS, 48 PPR
MAINS POWER SUPPLY	230V 50/60 Hz	230V 50/60 Hz
BATTERY OPERATION	(optional) 2 internal batteries 12V DC, 1.2 a/h (optional) 2 external batteries 12V DC, 4.5 Amp/h	(optional) 2 internal batteries 12V DC, 1.2 a/h (optional) 2 external batteries 12V DC, 4.5 Amp/h
ENERGY CONSUMPTION	Very low consumption	Very low consumption
NUMBER OF MOTORS	1 - 2 motors	1 - 2 motors
POWER SUPPLY FOR ACCESSORIES	24V DC	24V DC
FLASHING LIGHT TYPE	24V DC LED	24V DC LED
OUTPUT FOR GATE OPENING INDICATOR AND AUTOMATION SYSTEM ON WARNING LIGHT	✓	✓
OUTPUT FOR COURTESY LIGHT	40W	40W
TIMED AND GUARANTEED AUTOMATIC CLOSING	✓	✓
GATE EDGE SAFETY MANAGEMENT, 8.2KΩ OR STANDARD	✓	✓
LIMIT SWITCH TYPE	Adjustable mechanical component on base housing	Adjustable mechanical component on base housing
SEPARATE MANAGEMENT FOR MOTOR 1 - 2	✓	✓
FORCE ADJUSTMENT IN NOMINAL TRAVEL	✓	✓
FORCE ADJUSTMENT IN START-UP AND DECELERATION	✓	✓
OBSTACLE DETECTION - MOTOR REVERSAL	✓	✓
ADJUSTMENT IMPACT FORCE SEPARATE MOTOR 2	✓	✓
SPEED ADJUSTMENT	✓	✓
DECELERATION	✓	✓
STARTING ACCELERATION (SOFT-START)	✓	✓
GUARANTEED CLOSURE AND GUARANTEED APERTURE FUNCTION	✓	✓
WIND PROTECTION FUNCTION WITH GATE CLOSED	✓	✓
MOTOR STOPPING DISTANCE AND BRAKING DISTANCE	✓	✓
PARTIAL OPENING CONTROL	Pedestrian entry	Pedestrian entry
HUMAN PRESENCE CONTROL	✓	✓
LOCK MANAGEMENT	✓	✓
CONDOMINIUM FUNCTION	✓	✓
SAFETY DEVICE CONFIGURATION	✓	✓
INSTALLATION TEST FUNCTION	(prog button)	(prog button)
OPERATING TEMPERATURE	-20°C / +55°C	-20°C / +55°C
INVERTER THERMAL PROTECTION	✓	✓
CURRENT ABSORPTION MAPPING SYSTEM	(MCA)	(MCA)
RESTORE FACTORY DEFAULT VALUES	✓	✓
INFORMATION ON USE OF MOTOR	✓	✓
SECURITY PASSWORD MANAGEMENT	✓	✓

INSTALLATION

DIMENSIONS

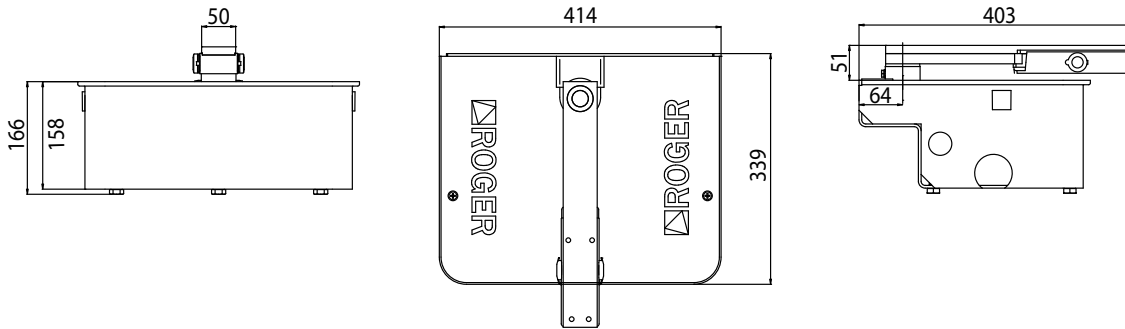

Note: all measurements in the drawings are in millimetres

OPERATING LIMITS

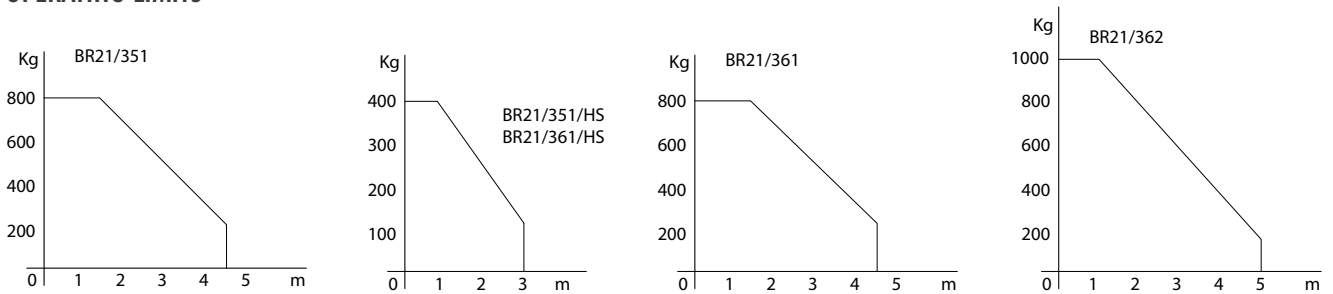

FOUNDATION BOXES

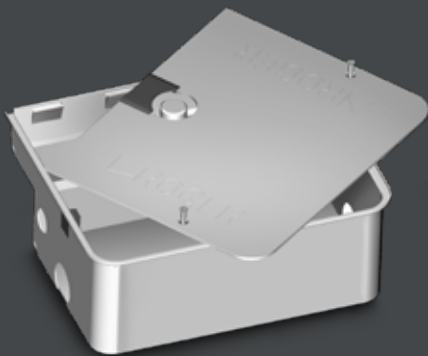

FU100

Cold galvanised foundation box and lid

FU101

Hot galvanised foundation box and lid

FU102











Hot galvanised foundation box and inox lid AISI 304

FU103

Foundation box and inox lid AISI 304



OPTIONAL ACCESSORIES

BR21: EVERYTHING YOU NEED FOR A COMPLETE, PROFESSIONAL INSTALLATION

	LT300	Levers for opening up to 125°		RL650	Release system with standard lever
	LT300/90SX	Levers for opening up to 103° - 90° turned - left		RL650/R	Release system with standard lever, reinforced steel version
	LT300/90DX	Levers for opening up to 103° - 90° turned - right		RL651	Release system with european cylinder key
	LT301	Levers for opening up to 360°		RL663	Long release lever for underground
	LT301/R	Levers for opening up to 360° , with reinforced chain		R99/C/001	Signboard "Automatic Opening"
	LT327/SC	Pinion gear $\frac{3}{4}$ Z13 of adaptation in pinion ombining $\frac{3}{4}$ Z16			

STANDARD ACCESSORIES

Always included in the individual product package or kit

		BR21-351 BR21-351-HS	BR21-361 BR21-362	FU100 / FU101 FU102 / FU103
	Always included in the individual product package or kit	✓	✓	
	Always included in the individual product package or kit			✓

STANDARD INSTALLATION

A PRACTICAL EXAMPLE FOR YOUR SUCCESSFUL INSTALLATION

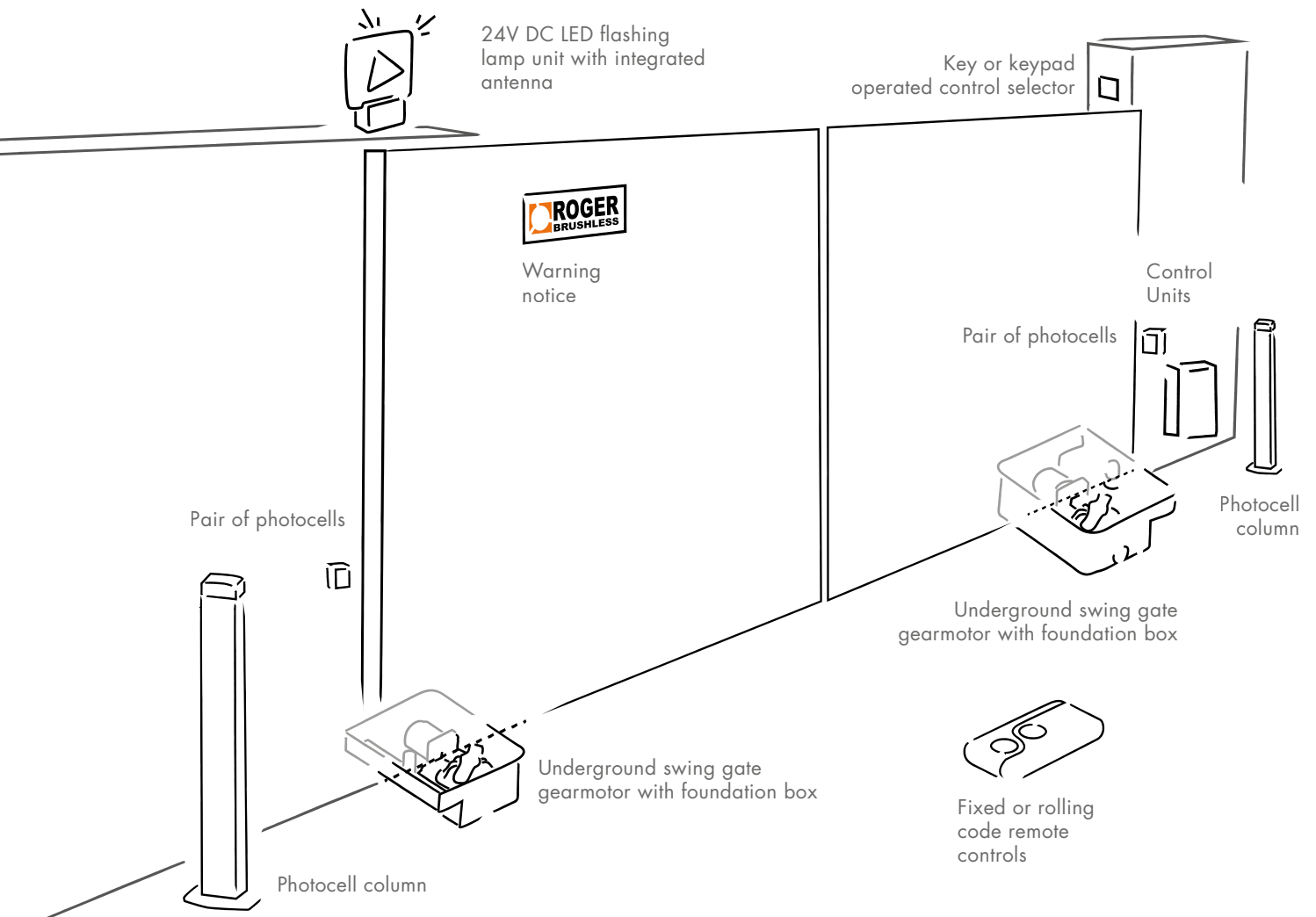

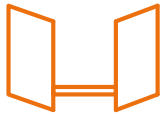

SWING GATE

15

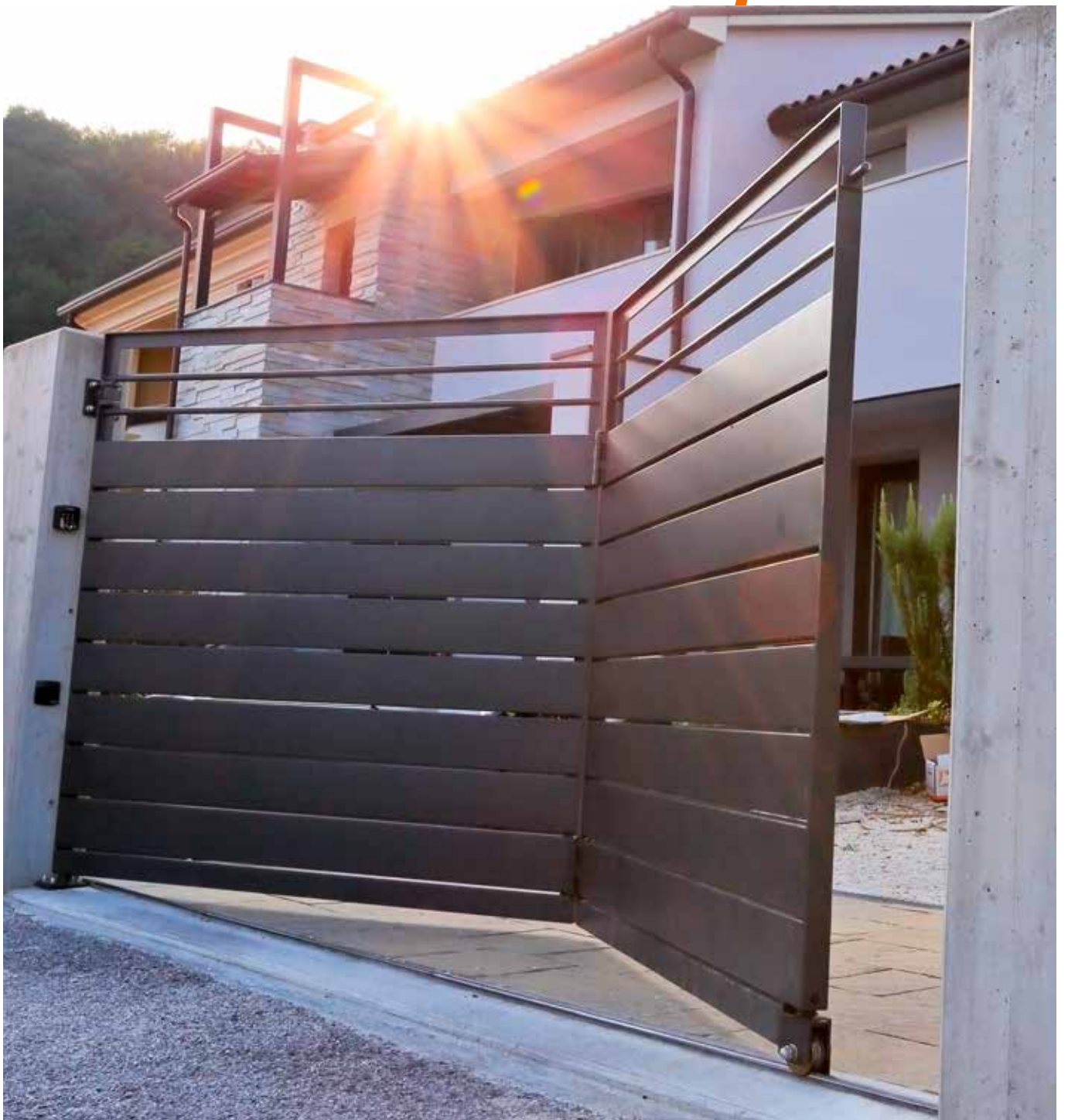



PREMIUM DEALER / PROFESSIONAL DEALER



100% Made in Italy

Via S. Botticelli, 8
31021 Bonisiolo di Mogliano Veneto (TV) · ITALY
T. +39 041 5937023 · F. +39 041 5937024

WWW.ROGERTECHNOLOGY.COM



WWW.WEAREBRUSHLESS.COM