

# BM30 SERIES

TODAY'S DIGITAL INTELLIGENCE  
MOVES YOUR GATE

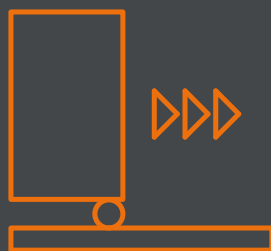

# WHAT WE DO

**INNOVATION, TOP NOTCH MECHANICS AND NEVER-ENDING TECHNOLOGICAL RESEARCH ARE THE ELEMENTS THAT MAKE ROGER TECHNOLOGY A UNIQUE AND DIFFERENT COMPANY**

Starting from our first day of work we immediately gave priority to the development and production of excellent, completely Italian mechanics, based only on top quality ferrous and non ferrous raw materials and guaranteed by impeccable production and surface treatment processes. It was just a few years later, starting in the 1990s, that we created the first major step in our history, by implementing a real mass production line for completely robotised motors, thus becoming a reference outsourcer for major brands of the gate automation market.

## PEOPLE, IDEAS AND PRODUCT EXPERIENCE

From the very beginning Roger Technology has evolved and grown because it's people believe that any bright idea can lead to great change in the future. Our people are passionate and innovative in our approach to every challenge, allways pushing the boundaries to develop extraordinary products.

In our language we translate the word "experience" as passion. It is this passion that drives us in the development of revolutionary **new products** that serve the real needs of our customers. We understand that our customers want a product designed around the way that they work.

*Primo Florian  
Founding partner  
Engineering  
and design*

*Dino Florian  
Founding President  
Development  
and design*

*Renato Florian  
Founding partner  
Assembly  
and quality*



# OUR PLUSES

## EXCELLENT RAW MATERIALS

Steel, ductile cast iron, aluminium, bronze, copper and titanium have always been the main and exclusive raw materials used in the advanced engineering processes of our company.



## PRODUCTION TECHNOLOGY

At Roger Technology all internal manufacturing is carried out on optimised production lines making use of very advanced technology. We have invested heavily in robotics and automated all product manufacturing phases. This ensures that all components and semi-finished products are highly reliable and are fully compliant with our exceptionally high quality standards.



## INTERNAL ASSEMBLY

Our highly qualified and dedicated staff oversee the fitting and assembly stages. Every piece of equipment is checked by our all italian personnel to ensure that we deliver reliable products to our customers.



## MADE IN ITALY

All solutions, products, design and the complete production process of Roger Technology is developed in Italy with the use of materials of primary quality always found in the market trough partner suppliers that share the same passion and professionalism of our company in developing products technologically reliable, efficient and simple in the way that they have been made for being installed and used.



# BRUSHLESS MOTOR

**A DIGITAL BRUSHLESS MOTOR WITH PERMANENT MAGNETIC FIELD, DIGITAL ELECTRONICS FOR THE COMPLETE MANAGEMENT OF THE AUTOMATION SYSTEM CONTROL. DESIGNED FOR SUPER INTENSIVE USE WITH THE ADDED BENEFIT OF A SUPER LOW POWER CONSUMPTION: THIS IS ROGER BRUSHLESS**

We are the creators at the heart of the product!  
All of our digital brushless motors are designed and manufactured in our own factories. Using dedicated automated machines the motors are wound with ultimate precision.

## DIGITAL BRUSHLESS MOTOR

Revolutionary and innovative digital Brushless motor with permanent magnetic field, three-phase sinusoidal power supply with native encoder that allows super-intensive use of the automation system with extremely low power consumption, not only providing 100% compliance with all the automation system management and safety rules, but setting new standards in gate safety.

## NEW GENERATION OF ELECTRONICS

The new control unit with onboard digital Brushless controller. Without traditional relays and due to the revolutionary MOSFET quadrant system and its control technology entirely based on a DSP (Digital Signal Processor) microcontroller, it represents a new generation of electronic cards created to safely handle all movement phases of the automation system.

## ENGINEERING PASSION

All the mechanical components and gears are manufactured in steel, cast iron and bronze. The automation system casings are made from titanium-reinforced die-cast aluminium. All the gears are inspected and assembled on high-quality bearings and inserted on precise seats machined to provide absolute precision between the axes.

**A TECHNOLOGY THAT OFFERS MAXIMUM PERFORMANCE  
BUT CONSUMES LESS POWER THAN OTHER MOTORS**

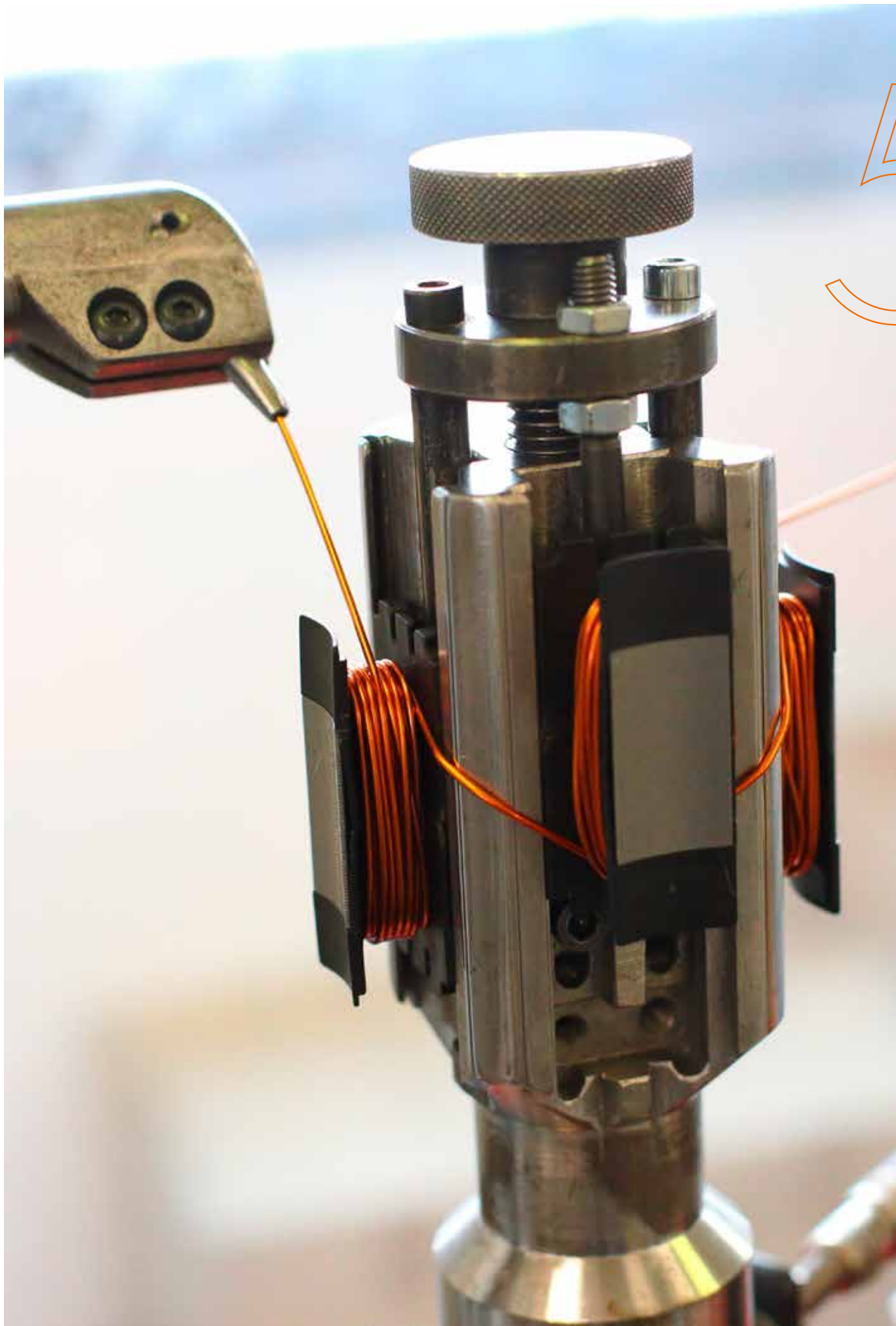

5

# COMPLETELY BRUSHLESS

## THE REVOLUTIONARY DIGITAL MOTOR WITH 12 UNIQUE FEATURES



### 3-PHASE DIGITAL BRUSHLESS MOTOR

A very powerful motor with substantial torque. The motor is compact and neat due to the special concentrated coil windings, it is powered by a **three phase sinusoidal system**.



### NO PROBLEM IN THE EVENT OF POWER FAILURE

With the help of internal or external batteries and the associated battery charging card, your automation system continues to operate for a considerable time **even during prolonged power cuts**, ensuring many more operations than traditional technologies.



### SPEED, ACCELERATION AND DECELERATION WITH EXTREME ELEGANCE

The automation system with brushless digital technology creates perfect and elegant movements. With a constant **force and torque** at every point and with the option of varying the speed on deceleration and acceleration the system can be managed with maximum safety.



### EXTREMELY LOW ENERGY CONSUMPTION

A motor that can operate at low voltage in super-intensive use and which can operate in environments with extremely demanding weather conditions while maintaining **very low energy consumption and absorption levels**. We can move a 600 kg sliding gate and use less than 30W of power.



### DIGITAL AND VECTORIAL AUTOMATION CONTROLLER

The BRUSHLESS digital controller, which operates at low voltage **24V/36V DC**, allows 100% control of the automation system in digital mode. Due to its operation entirely based on a DSP microcontroller the travel and all the movements of your automation system can therefore be programmed and customised easily, precisely and elegantly.



### MOTOR AT AMBIENT TEMPERATURE

The brushless motor was created with the main goal of being a motor for super intensive use and **with a 99% efficiency**. Regardless of how many operations the engine performs in a day, it always remains cold or at the most reaches the outside ambient temperature.





### THE DIGITAL SILENCE OF THE MOTOR

One great impact is the **silence** or the near absence of noise, generated by the BRUSHLESS motor during all its movements.



### MOTOR FOR SUPER-INTENSIVE USE

We wanted to surprise our customers with a product that was fundamentally different to any other product on the market. Fact: our motor remains **permanently cold** even after many days of super intensive use.



### IMPACT, OBSTACLE DETECTION AND REVERSAL IN TOTAL SAFETY

Thanks to digital technology we are able to **detect an obstacle** and reverse the motor instantly, by simply specifying the torque of the motor, the sensitivity, the time and the travel of the reversal. All in full compliance with safety requirements.



### ONBOARD NATIVE DIGITAL ENCODER

The BRUSHLESS motor has a highly advanced **native digital encoder** that controls management of automation systems in a safe, precise and extremely elegant manner.



### SIMPLE INSTALLATION WITH A SINGLE 3-WIRE CABLE

The BRUSHLESS motor can be installed by simply connecting it using three wires! What could be easier? This will provide full digital management of your automation system thanks to the **SENSELESS** and **SENSORED** (absolute encoder) technology incorporated in the BRUSHLESS sliding gate motors.



### ADVANCED PRECISION ENGINEERING TO OBTAIN OPTIMAL MOTOR PERFORMANCE

We have created a mechanism that gives you the opportunity to get **the maximum performance out of the motor**. A product which combines the quality of the internal production processes, the mechanical processing and the use of high quality ferrous and non-ferrous materials.

# WHY BRUSHLESS?

DIGITAL, SMART, POWERFUL, ELEGANT, ROBUST AND ALL-ITALIAN

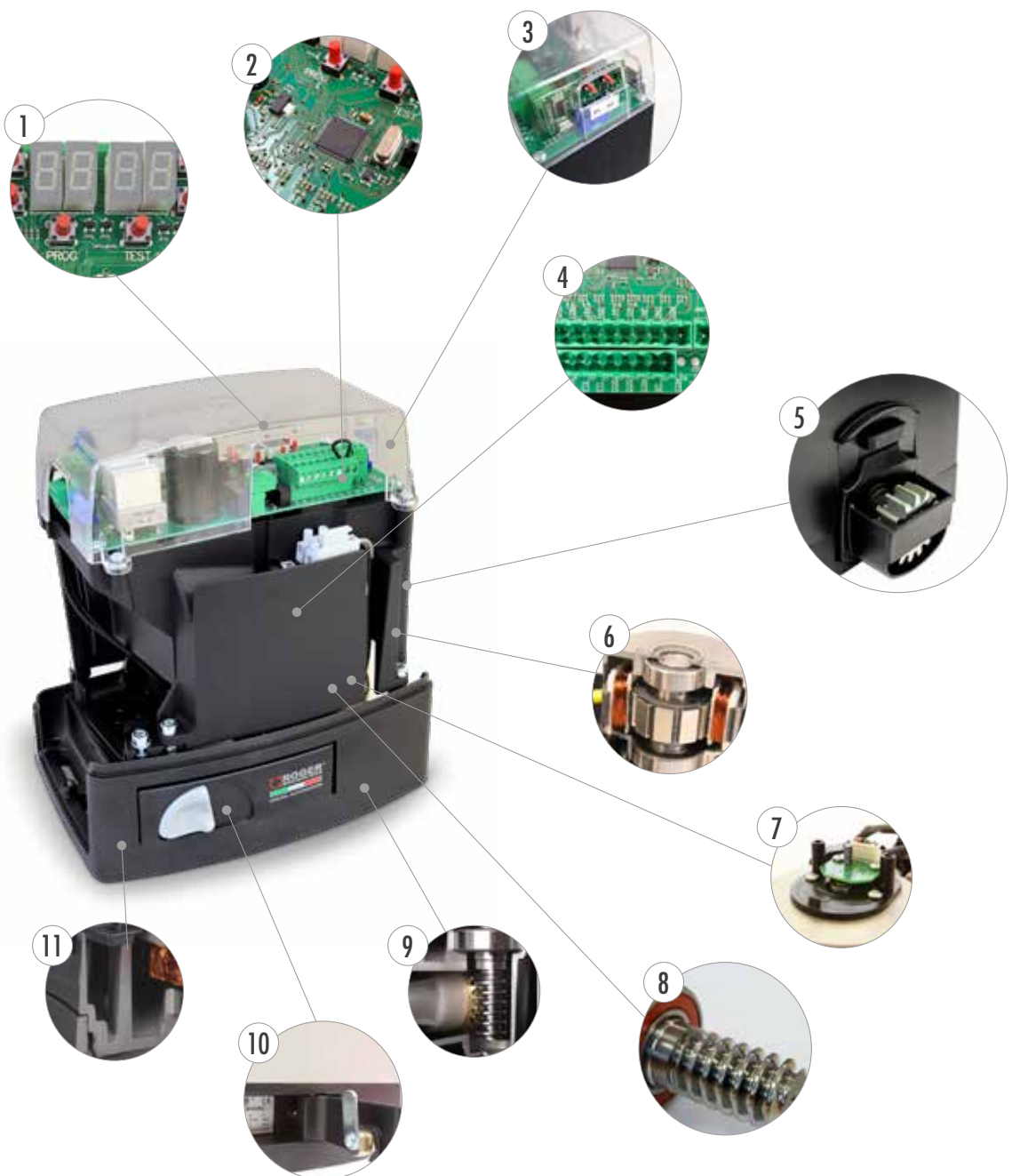



## 1 MULTIFUNCTION DIGITAL DISPLAY

4-quadrant digital display with 6 function keys that allow you to go through the various parameters, change their values, check error messages and input statuses and perform all the self-learning phases.

## 2 CONTROL ON DSP MICROCONTROLLER

Management of the BRUSHLESS motor by connection of a single 3-wire cable, with full digital management of your automation system thanks to the power control technology of the SENSORED motor.

## 3 PLUG-IN 2-CHANNEL RADIO RECEIVER

Powerful 2-channel radio receiver with up to 500 storable radio controls, available in fixed code or rolling code versions.

## 4 WIDE AVAILABILITY OF INPUTS

The digital controller offers a wide range of inputs for management and connection of all accessories and safety devices.

## 5 LIMIT SWITCH FOR ANY INSTALLATION

The whole range of sliding gate motors in the BM30 series is available with a mechanical limit switch or magnetic limit switch managed by the powerful onboard native digital encoder.

## 6 BRUSHLESS DIGITAL MOTOR

Digital brushless motor based on a permanent magnetic field which uses neodymium iron-boron magnets inside the rotor. With special concentrated coil windings, powered by a three-phase sinusoidal power system and available in 24V, 36V and 220V AC versions, the motor is extremely compact and operates at ambient temperature, guaranteeing super-intensive use with extremely low consumption.

## 7 EXTREMELY POWERFUL DIGITAL ENCODER

Thanks to the SENSORED technology and the native encoder in the motor, it is possible to exploit the technology provided by a motor encoder with a computing capacity of 4096 pulses per revolution. An effective power control that allows safe management of the automation system in all its movements, especially in the obstacle detection phases.

## 8 HIGH QUALITY WORM GEARS AND BEARINGS

Special worm gears and motor shafts obtained by pressure rolling processes guarantee durability and silence. Use of high-quality ball bearings with double protection.

## 9 HIGH PRECISION ENGINEERING

Reducer gears made with only with high quality materials such as aluminium, steel, cast iron and bronze; gears assembled with high-quality double-shielded ball bearings in order to obtain absolute precision between their axes.

## 10 ECCENTRIC ALUMINIUM LOCK RELEASE LEVER







The release lever is made entirely of aluminium with opening by key cylinder. The opening system is based on a very robust and powerful eccentric operating method, and on the principle of the double lever, which unlocks the automation system easily and reliably.

## 11 REINFORCED ALUMINIUM BODY

The BM30 body is made completely of aluminium reinforced with titanium. The thicknesses are increased and reinforced in the areas of greatest stress or possible wear. Treatment with epoxy paints to protect the body from the weather.



# TECHNICAL SPECIFICATIONS

	BM30/303/HS - BM30/303/HS/115	BM30/304/HS
<b>DESCRIPTION</b>	Electromechanical HIGH SPEED BRUSHLESS motor, low voltage, super intensive use, irreversible, ideal for sliding gates up to 400 kg. with built-in digital controller B70 series, mechanical limit switch.	Electromechanical HIGH SPEED BRUSHLESS motor, low voltage, super intensive use, irreversible, ideal for sliding gates up to 400 kg. with built-in digital controller B70 series, magnetic limit switch.
	 	 
MAX GATE WEIGHT	400 kg	400 kg
POWER LINE SUPPLY	230V AC / 115V AC - 50Hz	230V AC - 50Hz
MOTOR POWER SUPPLY	24V	24V
POWER RATING	125W	125W
FREQUENCY OF USE	Intensive use 	Intensive use 
THRUST	50 - 350N	50 - 350N
OPERATING TEMPERATURE	-20+55°C	-20+55°C
PROTECTION LEVEL	IP43	IP43
REDUCTOR TYPE	Irreversible	Irreversible
MANOEUVRE SPEED	26 m/min (0.44 m/s)	26 m/min (0.44 m/s)
LIMIT SWITCH	Mechanical	Magnetic
ONBOARD CONTROL UNIT	B70/1DC	B70/1DC
ENCODER	Digital native encoder + magnetic digital SENSORED, 4096 PPR	Digital native encoder + magnetic digital SENSORED, 4096 PPR
TYPE EXIT GEAR	Z15/mod 4	Z15/mod 4
OPERATING CYCLES PER DAY (OPENING/CLOSING - 24 HOURS NO STOP)	500	500
MAXIMUM DIMENSION PRODUCT IN MM (L X W X H)	250 x 165 x 290	250 x 165 x 290
PRODUCT WEIGHT PACKED (KG)	10,4	10,7



Brushless  
Motor



Intensive  
Use

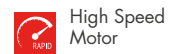

High Speed  
Motor

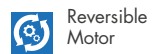

Reversible  
Motor



## PACKAGING

L.: 35 cm  
W.: 23 cm  
H. 35 cm

# FUNCTIONS

## OF AUTOMATED SLIDING GATE MOTOR

DESCRIPTION	BM30/303/HS - BM30/303/HS/115	BM30/304/HS
<b>MAX GATE WEIGHT</b>	<b>UP TO A 400 KG</b>	<b>UP TO A 400 KG</b>
ONBOARD DIGITAL CONTROLLER	B70/1DC	B70/1DC
RADIO RECEIVER TYPE	H93/RX20/1 with fixed code connection H93/RX22A/1 with fixed code connection H93/RX2RC/1 with rolling code connection	H93/RX20/1 with fixed code connection H93/RX22A/1 with fixed code connection H93/RX2RC/1 with rolling code connection
MOTOR POWER SUPPLY	24V DC	24V DC
MOTOR MANAGEMENT TECHNOLOGY (ETC)	SENSORED technology	SENSORED technology
ENCODER TYPE	Magnetic Digital SENSORED, 4096 pulses per revolution	Magnetic Digital SENSORED, 4096 pulses per revolution
MAINS POWER SUPPLY	230V 50/60 Hz	230V 50/60 Hz
BATTERY OPERATION	Not provided	Not provided
ENERGY CONSUMPTION	Very low consumption	Very low consumption
NUMBER OF MOTORS	1	1
POWER SUPPLY FOR ACCESSORIES	24V DC	24V DC
FLASHING LIGHT TYPE	24V DC LED	24V DC LED
OUTPUT FOR GATE OPENING INDICATOR AND AUTOMATION SYSTEM ON WARNING LIGHT	✓	✓
OUTPUT FOR COURTESY LIGHT	40W	40W
TIMED AND GUARANTEED AUTOMATIC CLOSING	✓	✓
GATE EDGE SAFETY MANAGEMENT, 8.2KΩ OR STANDARD	✓	✓
LIMIT SWITCH TYPE	Mechanical	Magnetic
FORCE ADJUSTMENT IN NOMINAL MOVEMENT	✓	✓
FORCE ADJUSTMENT IN START-UP AND DECELERATION	✓	✓
OBSTACLE DETECTION (ALSO IN POSITION RECOVERY MODE) - MOTOR REVERSAL	✓	✓
SPEED ADJUSTMENT	Adjustable separately in opening and closure	Adjustable separately in opening and closure
DECELERATION	Adjustable separately in opening and closure	Adjustable separately in opening and closure
MANAGEMENT OF THE SLOWDOWN STARTING POINT	✓	✓
STARTING ACCELERATION (SOFT-START)	Adjustable separately in opening and closure	Adjustable separately in opening and closure
GUARANTEED CLOSING	✓	✓
STOPPING SPACE AND MOTOR BRAKING	✓	✓
PARTIAL OPENING CONTROL	Pedestrian entry	Pedestrian entry
HUMAN PRESENCE CONTROL	✓	✓
CONDOMINIUM FUNCTION	✓	✓
SAFETY DEVICE CONFIGURATION	✓	✓
INSTALLATION TEST FUNCTION	(prog button)	(prog button)
OPERATING TEMPERATURE	-20°C/+55°C	-20°C/+55°C
INVERTER THERMAL PROTECTION	✓	✓
RESTORE FACTORY DEFAULT VALUES	✓	✓
INFORMATION ON USE OF MOTOR	✓	✓
SECURITY PASSWORD MANAGEMENT	✓	✓

# INSTALLATION

## DIMENSIONS

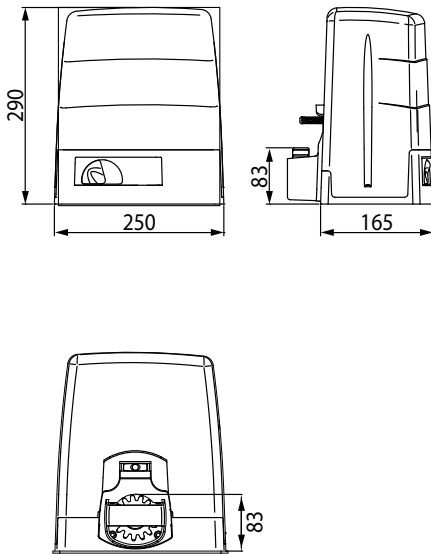

## PREPARATIONS FOR STANDARD INSTALLATION

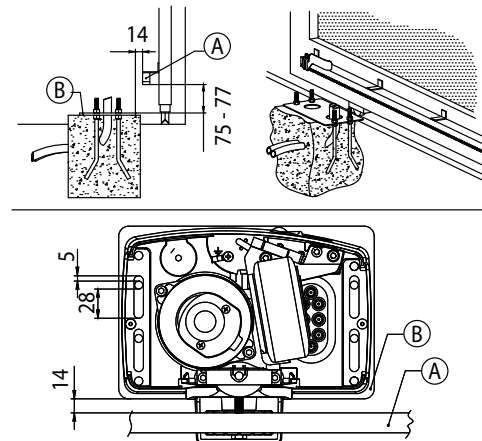

A = Rack  
B = Fastening plate (thickness 3mm)

Note: all measurements in the drawings are in millimetres

## KIT

### KIT BM30/326/HS

Sliding gates up to 400 kg,  
magnetic limit switch

### CONTENTS OF STANDARD BM30 SLIDING GATE MOTOR KIT



1 sliding gate motor with onboard digital controller



1 radio receiver with 2 fixed code channels, H93 series



2 fixed code remote control units with copying function, Synus series



1 pair of photocells, R90 series



24V DC LED flashing lamp unit with integrated antenna



1 "Automatic Opening" warning notice

The composition of the kit is subject to change in the nature or quantity of the items. For the correct content of the kits always refer to the catalogue, the current sales price lists or the online product catalogue at

[WWW.ROGERTECHNOLOGY.COM](http://WWW.ROGERTECHNOLOGY.COM)



## OPTIONAL ACCESSORIES

BM30: EVERYTHING YOU NEED FOR A COMPLETE, PROFESSIONAL INSTALLATION

	<b>KT220</b>	Raised fixing plate for M30 series (+3 cm).		<b>GA554</b>	Pocket of 6 spacers (2,5 Cm) and screws.
	<b>GA550</b>	Galvanised steel rack 22x22x1000 module 4.		<b>GA557</b>	Roger Technology nylon rack module 4 with 6 connectors L.1000.
	<b>GA551</b>	Galvanised steel rack 30x12x1000 module 4 with spacers and screws.		<b>R99/C/001</b>	Signboard "Automatic Opening".

## STANDARD ACCESSORIES

Always included in the individual product package or kit

			<b>BM30/303/HS</b> <b>BM30/303/HS/115</b>	<b>BM30/304/HS</b>
	<b>KT223</b>	Fixing plate with stay bolts and screws M30 series	✓	✓
	<b>MC773</b>	Kit mechanical limit switch for control unit H70/103AC, H70/104AC, B70/1DC, B70/1DCHP	✓	
	<b>MC775</b>	Kit magnetic limit switch for control unit H70/103AC, H70/104AC, B70/1DC, B70/1DCHP		✓



# STANDARD INSTALLATION

A PRACTICAL EXAMPLE FOR YOUR SUCCESSFUL INSTALLATION

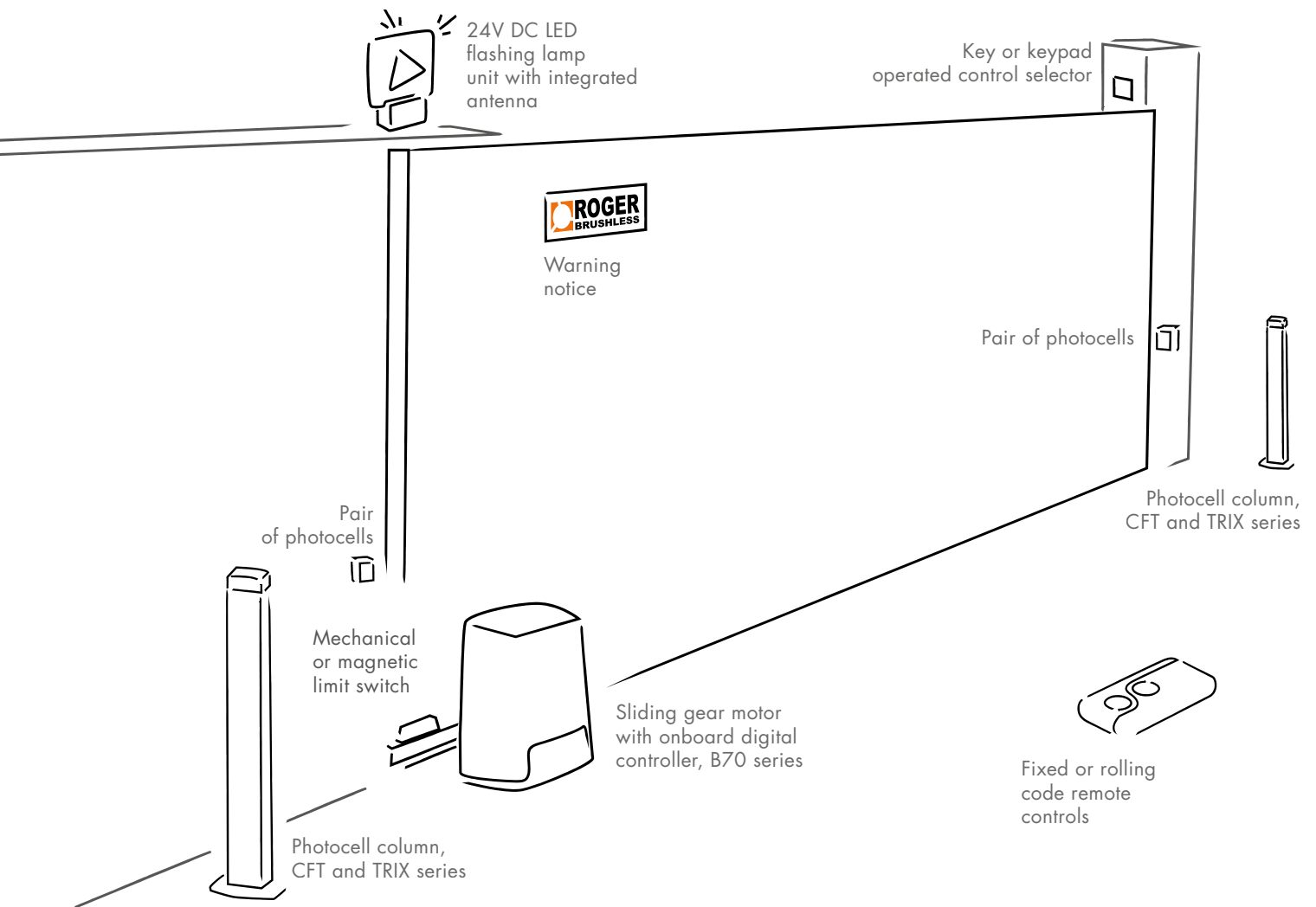



SLIDING GATE





PREMIUM DEALER / PROFESSIONAL DEALER



100% Made in Italy

Via S. Botticelli, 8  
31021 Bonisiolo di Mogliano Veneto (TV) · ITALY  
T. +39 041 5937023 · F. +39 041 5937024

[WWW.ROGERTECHNOLOGY.COM](http://WWW.ROGERTECHNOLOGY.COM)



[WWW.WEAREBRUSHLESS.COM](http://WWW.WEAREBRUSHLESS.COM)