

BG30 SERIES

TODAY'S DIGITAL INTELLIGENCE
MOVES YOUR GATE

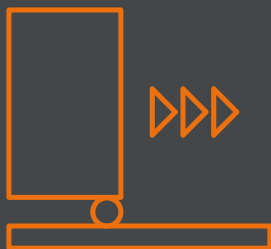

WHAT WE DO

INNOVATION, TOP NOTCH MECHANICS AND NEVER-ENDING TECHNOLOGICAL RESEARCH ARE THE ELEMENTS THAT MAKE ROGER TECHNOLOGY A UNIQUE AND DIFFERENT COMPANY

Starting from our first day of work we immediately gave priority to the development and production of excellent, completely Italian mechanics, based only on top quality ferrous and non ferrous raw materials and guaranteed by impeccable production and surface treatment processes. It was just a few years later, starting in the 1990s, that we created the first major step in our history, by implementing a real mass production line for completely robotised motors, thus becoming a reference outsourcer for major brands of the gate automation market.

PEOPLE, IDEAS AND PRODUCT EXPERIENCE

From the very beginning Roger Technology has evolved and grown because it's people believe that any bright idea can lead to great change in the future. Our people are passionate and innovative in our approach to every challenge, allways pushing the boundaries to develop extraordinary products.

In our language we translate the word "experience" as passion. It is this passion that drives us in the development of revolutionary **new products** that serve the real needs of our customers. We understand that our customers want a product designed around the way that they work.

*Primo Florian
Founding partner
Engineering
and design*

*Dino Florian
Founding President
Development
and design*

*Renato Florian
Founding partner
Assembly
and quality*



OUR PLUSES

EXCELLENT RAW MATERIALS

Steel, ductile cast iron, aluminium, bronze, copper and titanium have always been the main and exclusive raw materials used in the advanced engineering processes of our company.



PRODUCTION TECHNOLOGY

At Roger Technology all internal manufacturing is carried out on optimised production lines making use of very advanced technology. We have invested heavily in robotics and automated all product manufacturing phases. This ensures that all components and semi-finished products are highly reliable and are fully compliant with our exceptionally high quality standards.



INTERNAL ASSEMBLY

Our highly qualified and dedicated staff oversee the fitting and assembly stages. Every piece of equipment is checked by our all italian personnel to ensure that we deliver reliable products to our customers.



MADE IN ITALY

All solutions, products, design and the complete production process of Roger Technology is developed in Italy with the use of materials of primary quality always found in the market trough partner suppliers that share the same passion and professionalism of our company in developing products technologically reliable, efficient and simple in the way that they have been made for being installed and used.



BRUSHLESS MOTOR

A DIGITAL BRUSHLESS MOTOR WITH PERMANENT MAGNETIC FIELD, DIGITAL ELECTRONICS FOR THE COMPLETE MANAGEMENT OF THE AUTOMATION SYSTEM CONTROL. DESIGNED FOR SUPER INTENSIVE USE WITH THE ADDED BENEFIT OF A SUPER LOW POWER CONSUMPTION: THIS IS ROGER BRUSHLESS

We are the creators at the heart of the product!
All of our digital brushless motors are designed and manufactured in our own factories. Using dedicated automated machines the motors are wound with ultimate precision.

DIGITAL BRUSHLESS MOTOR

Revolutionary and innovative digital Brushless motor with permanent magnetic field, three-phase sinusoidal power supply with native encoder that allows super-intensive use of the automation system with extremely low power consumption, not only providing 100% compliance with all the automation system management and safety rules, but setting new standards in gate safety.

NEW GENERATION OF ELECTRONICS

The new control unit with onboard digital Brushless controller. Without traditional relays and due to the revolutionary MOSFET quadrant system and its control technology entirely based on a DSP (Digital Signal Processor) microcontroller, it represents a new generation of electronic cards created to safely handle all movement phases of the automation system.

ENGINEERING PASSION

All the mechanical components and gears are manufactured in steel, cast iron and bronze. The automation system casings are made from titanium-reinforced die-cast aluminium. All the gears are inspected and assembled on high-quality bearings and inserted on precise seats machined to provide absolute precision between the axes.

**A TECHNOLOGY THAT OFFERS MAXIMUM PERFORMANCE
BUT CONSUMES LESS POWER THAN OTHER MOTORS**

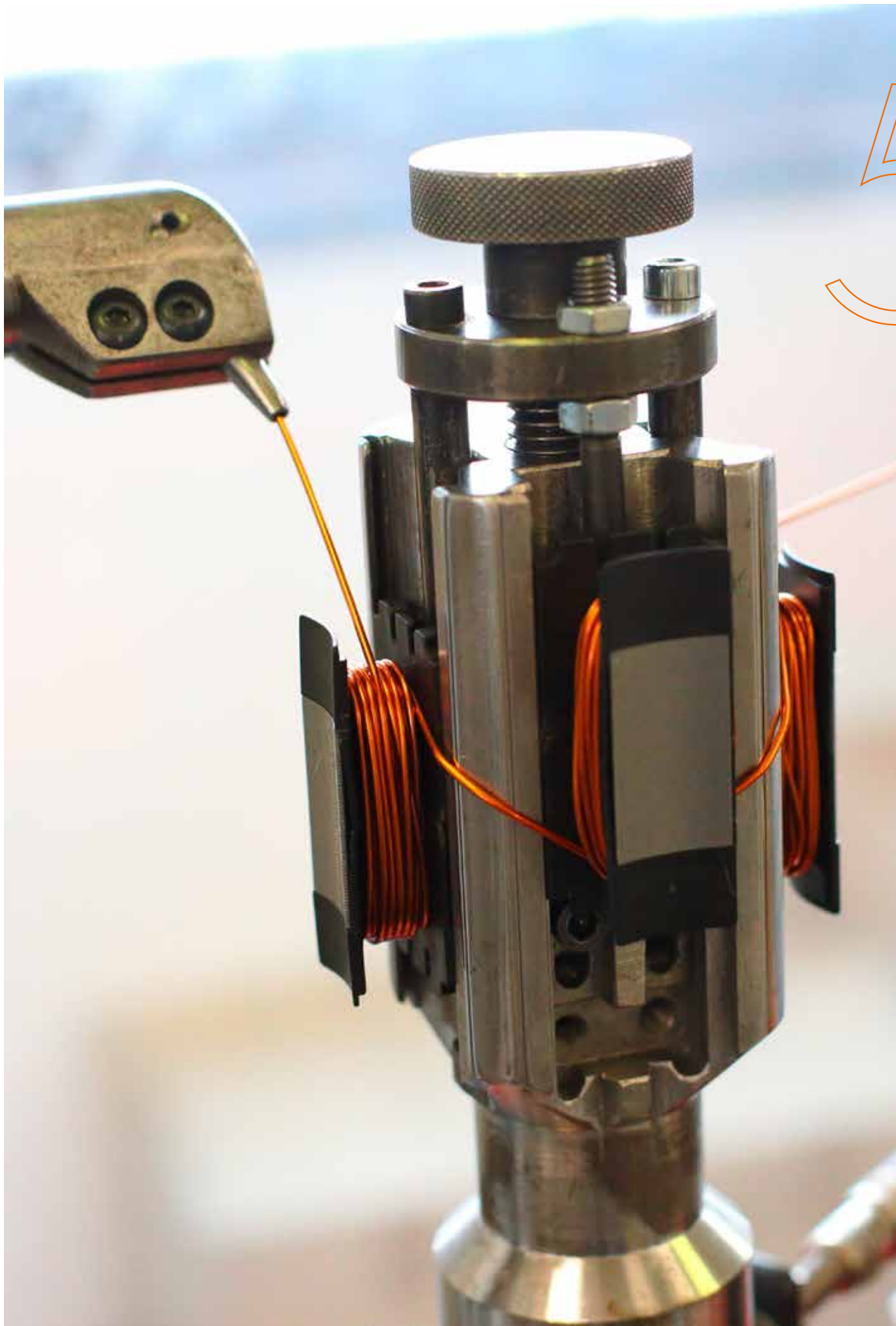

5

COMPLETELY BRUSHLESS

THE REVOLUTIONARY DIGITAL MOTOR WITH 12 UNIQUE FEATURES



3-PHASE DIGITAL BRUSHLESS MOTOR

A very powerful motor with substantial torque. The motor is compact and neat due to the special concentrated coil windings, it is powered by a **three phase sinusoidal system**.



NO PROBLEM IN THE EVENT OF POWER FAILURE

With the help of internal or external batteries and the associated battery charging card, your automation system continues to operate for a considerable time **even during prolonged power cuts**, ensuring many more operations than traditional technologies.



SPEED, ACCELERATION AND DECELERATION WITH EXTREME ELEGANCE

The automation system with brushless digital technology creates perfect and elegant movements. With a constant **force and torque** at every point and with the option of varying the speed on deceleration and acceleration the system can be managed with maximum safety.



EXTREMELY LOW ENERGY CONSUMPTION

A motor that can operate at low voltage in super-intensive use and which can operate in environments with extremely demanding weather conditions while maintaining **very low energy consumption and absorption levels**. We can move a 600 kg sliding gate and use less than 30W of power.



DIGITAL AND VECTORIAL AUTOMATION CONTROLLER

The BRUSHLESS digital controller, which operates at low voltage **24V/36V DC**, allows 100% control of the automation system in digital mode. Due to its operation entirely based on a DSP microcontroller the travel and all the movements of your automation system can therefore be programmed and customised easily, precisely and elegantly.



MOTOR AT AMBIENT TEMPERATURE

The brushless motor was created with the main goal of being a motor for super intensive use and **with a 99% efficiency**. Regardless of how many operations the engine performs in a day, it always remains cold or at the most reaches the outside ambient temperature.



THE DIGITAL SILENCE OF THE MOTOR

One great impact is the **silence** or the near absence of noise, generated by the BRUSHLESS motor during all its movements.



MOTOR FOR SUPER-INTENSIVE USE

We wanted to surprise our customers with a product that was fundamentally different to any other product on the market. Fact: our motor remains **permanently cold** even after many days of super intensive use.



IMPACT, OBSTACLE DETECTION AND REVERSAL IN TOTAL SAFETY

Thanks to digital technology we are able to **detect an obstacle** and reverse the motor instantly, by simply specifying the torque of the motor, the sensitivity, the time and the travel of the reversal. All in full compliance with safety requirements.



ONBOARD NATIVE DIGITAL ENCODER

The BRUSHLESS motor has a highly advanced **native digital encoder** that controls management of automation systems in a safe, precise and extremely elegant manner.



SIMPLE INSTALLATION WITH A SINGLE 3-WIRE CABLE

The BRUSHLESS motor can be installed by simply connecting it using three wires! What could be easier? This will provide full digital management of your automation system thanks to the **SENSELESS** and **SENSORED** (absolute encoder) technology incorporated in the BRUSHLESS sliding gate motors.



ADVANCED PRECISION ENGINEERING TO OBTAIN OPTIMAL MOTOR PERFORMANCE

We have created a mechanism that gives you the opportunity to get **the maximum performance out of the motor**. A product which combines the quality of the internal production processes, the mechanical processing and the use of high quality ferrous and non-ferrous materials.

WHY BRUSHLESS?

DIGITAL, SMART, POWERFUL, ELEGANT, ROBUST AND ALL-ITALIAN



1 **STANDBY BATTERIES IN THE EVENT OF POWER FAILURE**

No problem in case of blackout, thanks to the onboard charging card housed in a protected position inside the gate operator cover. In Plug-In Mode the onboard charging card allows to manage two external 12V DC / 4,5 Amp/H standby batteries.

2 **MULTIFUNCTION DIGITAL DISPLAY**

4-quadrant digital display with 6 function keys that allow you to go through the various parameters, change their values, check error messages and input statuses and perform all the self-learning phases.

3 **MICRO-CONTROLLER WITH DSP TECHNOLOGY**

The digital controller controls the brushless motor via a single 3 core cable, managing your automation system entirely digitally with SENSORED motor power control technology.

4 **PLUG-IN 2-CHANNEL RADIO RECEIVER**

Powerful 2-channel radio receiver with up to 500 storable radio controls, available in fixed code or rolling code versions.

5 **WIDE AVAILABILITY OF INPUTS**

The digital controller offers a wide range of inputs for management and connection of all accessories and safety devices.

6 **LIMIT SWITCH FOR ANY INSTALLATION**

The whole range of sliding gate motors in the BG30 series is available with a mechanical limit switch or magnetic limit switch managed by the powerful onboard native digital encoder.

7 **BRUSHLESS DIGITAL MOTOR**

Digital brushless motor based on a permanent magnetic field which uses neodymium iron-boron magnets inside the rotor. With special concentrated coil windings, powered by a three-phase sinusoidal power system and available in 24V, 36V and 220V AC versions, the motor is extremely compact and operates at ambient temperature, guaranteeing super-intensive use with extremely low consumption.

8 **EXTREMELY POWERFUL DIGITAL ENCODER**

Thanks to the SENSORED technology and the native encoder in the motor, it is possible to exploit the technology provided by a motor encoder with a computing capacity of 4096 pulses per revolution. An effective power control that allows safe management of the automation system in all its movements, especially in the obstacle detection phases.

9 **HIGH QUALITY WORM GEARS AND BEARINGS**

Special worm gears and motor shafts obtained by pressure rolling processes guarantee durability and silence. Use of high-quality ball bearings with double protection.

10 **HIGH PRECISION ENGINEERING**

Reducer gears made with only with high quality materials such as aluminium, steel, cast iron and bronze; gears assembled with high-quality double-shielded ball bearings in order to obtain absolute precision between their axes.

11 **ECCENTRIC ALUMINIUM LOCK RELEASE LEVER**













The release lever is made entirely of aluminium with opening by key cylinder. The opening system is based on a very robust and powerful eccentric operating method, and on the principle of the double lever, which unlocks the automation system easily and reliably.

12 **REINFORCED ALUMINIUM BODY**

The BG30 body is made completely of aluminium reinforced with titanium. The thicknesses are increased and reinforced in the areas of greatest stress or possible wear. Treatment with epoxy paints to protect the body from the weather.



TECHNICAL SPECIFICATIONS

	BG30/1004/HS	BG30/1404/R	BG30/1504/HS	BG30/1604	BG30/1804/HS	BG30/2204
DESCRIPTION	Electromechanical HIGH SPEED BRUSHLESS motor, low voltage, super intensive use, with native encoder onboard, irreversible ideal for sliding gates up to 1000 Kg. with built-in digital controller B70 series, magnetic limit switch.	Electromechanical BRUSHLESS motor, low voltage, super intensive use, with native encoder onboard, reversible ideal for sliding gates up to 1400 Kg. with built-in digital controller B70 series, magnetic limit switch.	Electromechanical HIGH SPEED BRUSHLESS motor, low voltage, super intensive use, with native encoder onboard, irreversible ideal for sliding gates up to 1500 kg. with built-in digital controller B70 series, with magnetic limit switch.	Electromechanical BRUSHLESS motor, low voltage, super intensive use, with native encoder onboard, irreversible ideal for sliding gates up to 1600 Kg. with built-in digital controller B70 series, magnetic limit switch.	Electromechanical HIGH SPEED BRUSHLESS motor, low voltage, super intensive use, with native encoder onboard, irreversible ideal for sliding gates up to 1800 kg. with built-in digital controller B70 series, with magnetic limit switch.	Electromechanical BRUSHLESS motor, low voltage, super intensive use, with native encoder onboard, irreversible ideal for sliding gates up to 2200 kg with built-in digital controller B70 series, magnetic limit switch.
						
MAX GATE WEIGHT	1000 kg	1400 kg	1500 kg	1600 kg	1800 kg	2200 kg
POWER LINE SUPPLY	230V AC - 50Hz	230V AC - 50Hz	230V AC - 50Hz	230V AC - 50Hz	230V AC - 50Hz	230V AC - 50Hz
MOTOR POWER SUPPLY	36V	36V	36V	36V	36V	36V
POWER RATING	590W	540W	650W	390W	650W	470W
FREQUENCY OF USE	Intensive use 	Intensive use 	Intensive use 	Intensive use 	Intensive use 	Intensive use 
THRUST	50 - 800N	50 - 600N	50 - 1000N	50 - 1200N	50 - 1250N	50 - 1700N
OPERATING TEMPERATURE	-20+55°C	-20+55°C	-20+55°C	-20+55°C	-20+55°C	-20+55°C
PROTECTION LEVEL	IP43	IP43	IP43	IP43	IP43	IP43
REDUCTOR TYPE	Irreversible	Reversible 	Irreversible	Irreversible	Irreversible	Irreversible
MANOEUVRE SPEED	20 m/min (0.33 m/s)	17 m/min (0.28 m/s)	25 m/min (0.42 m/s)	12 m/min (0.20 m/s)	18 m/min (0.30 m/s)	12 m/min (0.16 m/s)
LIMIT SWITCH	Magnetic	Magnetic	Magnetic	Magnetic	Magnetic	Magnetic
ONBOARD CONTROL UNIT	B70/1DCHP	B70/1DCHP	B70/1DCHP	B70/1DCHP	B70/1DCHP	B70/1DCHP
ENCODER	Digital native encoder + magnetic digital SENSORED, 4096 PPR	Digital native encoder + magnetic digital SENSORED, 4096 PPR	Digital native encoder + magnetic digital SENSORED, 4096 PPR	Digital native encoder + magnetic digital SENSORED, 4096 PPR	Digital native encoder + magnetic digital SENSORED, 4096 PPR	Digital native encoder + magnetic digital SENSORED, 4096 PPR
BATTERIES RECOVERY	Optional 2 external battery 12V 4,5AH	Optional 2 external battery 12V 4,5AH	Optional 2 external battery 12V 4,5AH	Optional 2 external battery 12V 4,5AH	Optional 2 external battery 12V 4,5AH	Optional 2 external battery 12V 4,5AH
TYPE EXIT GEAR	Z17/mod 4	Z17/mod 4	Z20/mod 4	Z17/mod 4	Z17/mod 4	Z17/mod 4
OPERATING CYCLES PER DAY (OPENING/CLOSING - 24 HOURS NO STOP)	800	800	800	1000	800	1000
MAXIMUM DIMENSION PRODUCT IN MM (LXWXH)	346 x 180 x 362	346 x 180 x 362	346 x 180 x 362	346 x 180 x 362	346 x 180 x 362	346 x 180 x 362
PRODUCT WEIGHT PACKED (KG)	19,6	20	20,1	19,6	20,1	20,1



Brushless Motor



Intensive Use



High Speed Motor



Reversible Motor



PACKAGING

L.: 38 cm
W.: 23 cm
H.: 39 cm

FUNCTIONS

OF AUTOMATED SLIDING GATE MOTOR

DESCRIPTION	BG30/1004/HS	BG30/1404/R	BG30/1504/HS	BG30/1604	BG30/1804/HS	BG30/2204
MAX GATE WEIGHT	1000 KG	1400 KG	1500 KG	1600 KG	1800 KG	2200 KG
ONBOARD DIGITAL CONTROLLER	B70/1DCHP	B70/1DCHP	B70/1DCHP	B70/1DCHP	B70/1DCHP	B70/1DCHP
RADIO RECEIVER TYPE	H93/RX20/I and H93/RX22A/I with fixed code connection H93/RX2RC/I with rolling code connection	H93/RX20/I and H93/RX22A/I with fixed code connection H93/RX2RC/I with rolling code connection	H93/RX20/I and H93/RX22A/I with fixed code connection H93/RX2RC/I with rolling code connection	H93/RX20/I and H93/RX22A/I with fixed code connection H93/RX2RC/I with rolling code connection	H93/RX20/I and H93/RX22A/I with fixed code connection H93/RX2RC/I with rolling code connection	H93/RX20/I and H93/RX22A/I with fixed code connection H93/RX2RC/I with rolling code connection
MOTOR POWER SUPPLY	36V DC	36V DC	36V DC	36V DC	36V DC	36V DC
ENCODER TYPE (ETC)	Magnetic Digital SENSORED, 4096 pulses per revolution	Magnetic Digital SENSORED, 4096 pulses per revolution	Magnetic Digital SENSORED, 4096 pulses per revolution	Magnetic Digital SENSORED, 4096 pulses per revolution	Magnetic Digital SENSORED, 4096 pulses per revolution	Magnetic Digital SENSORED, 4096 pulses per revolution
MAINS POWER SUPPLY	230V 50/60 Hz	230V 50/60 Hz	230V 50/60 Hz	230V 50/60 Hz	230V 50/60 Hz	230V 50/60 Hz
BATTERY OPERATION	(optional) 2 external batteries 12V DC, 4.5 a/h	(optional) 2 external batteries 12V DC, 4.5 a/h	(optional) 2 external batteries 12V DC, 4.5 a/h	(optional) 2 external batteries 12V DC, 4.5 a/h	(optional) 2 external batteries 12V DC, 4.5 a/h	(optional) 2 external batteries 12V DC, 4.5 a/h
ENERGY CONSUMPTION	Very low consumption	Very low consumption	Very low consumption	Very low consumption	Very low consumption	Very low consumption
POWER SUPPLY FOR ACCESSORIES	24V DC	24V DC	24V DC	24V DC	24V DC	24V DC
FLASHING LIGHT TYPE	24V DC LED	24V DC LED	24V DC LED	24V DC LED	24V DC LED	24V DC LED
OUTPUT FOR GATE OPENING INDICATOR AND AUTOMATION SYSTEM ON WARNING LIGHT	✓	✓	✓	✓	✓	✓
OUTPUT FOR COURTESY LIGHT	40W	40W	40W	40W	40W	40W
TIMED AND GUARANTEED AUTOMATIC CLOSING	✓	✓	✓	✓	✓	✓
GATE EDGE SAFETY MANAGEMENT, 8.2KΩ OR STANDARD	✓	✓	✓	✓	✓	✓
FORCE ADJUSTMENT IN NOMINAL IN START-UP AND DECELERATION	✓	✓	✓	✓	✓	✓
OBSTACLE DETECTION (ALSO IN POSITION RECOVERY MODE) - MOTOR REVERSAL	✓	✓	✓	✓	✓	✓
SPEED ADJUSTMENT	Adjustable separately opening & closure	Adjustable separately opening & closure	Adjustable separately opening & closure	✓	Adjustable separately opening & closure	✓
DECELERATION	Adjustable separately opening & closure	Adjustable separately opening & closure	Adjustable separately opening & closure	✓	Adjustable separately opening & closure	✓
MANAGEMENT OF THE SLOWDOWN STARTING POINT	✓	✓	✓	✓	✓	✓
STARTING ACCELERATION (SOFT-START)	Adjustable separately opening & closure	Adjustable separately opening & closure	Adjustable separately opening & closure	✓	Adjustable separately opening & closure	✓
GUARANTEED CLOSING	✓	✓	✓	✓	✓	✓
PARTIAL OPENING CONTROL	Pedestrian entry	Pedestrian entry	Pedestrian entry	Pedestrian entry	Pedestrian entry	Pedestrian entry
HUMAN PRESENCE CONTROL	✓	✓	✓	✓	✓	✓
CONDOMINIUM FUNCTION	✓	✓	✓	✓	✓	✓
SAFETY DEVICE CONFIGURATION	✓	✓	✓	✓	✓	✓
INSTALLATION TEST FUNCTION	(prog button)	(prog button)	(prog button)	(prog button)	(prog button)	(prog button)
OPERATING TEMPERATURE	-20°C/+55°C	-20°C/+55°C	-20°C/+55°C	-20°C/+55°C	-20°C/+55°C	-20°C/+55°C
INVERTER THERMAL PROTECTION	✓	✓	✓	✓	✓	✓
RESTORE FACTORY DEFAULT VALUES	✓	✓	✓	✓	✓	✓
INFORMATION ON USE OF MOTOR	✓	✓	✓	✓	✓	✓
SECURITY PASSWORD MANAGEMENT	✓	✓	✓	✓	✓	✓
EXP B-CONNECT INPUT PREDISPOSITION	✓	✓	✓	✓	✓	✓

INSTALLATION

DIMENSIONS

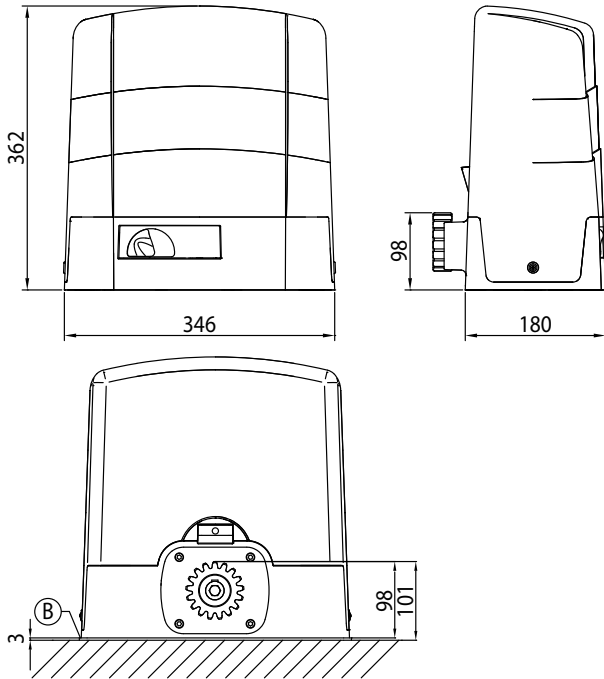

PREPARATIONS FOR STANDARD INSTALLATION

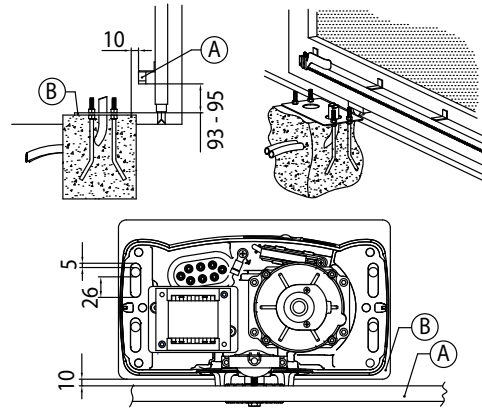

A = Rack
B = Fastening plate (thickness 3mm)

Note: all measurements in the drawings are in millimetres

BG30 EVOLUTION





OPTIONAL ACCESSORIES

BG30: EVERYTHING YOU NEED FOR A COMPLETE, PROFESSIONAL INSTALLATION

	KT222	Raised fixing plate for G30 series		GA554	Pocket of 6 spacers and screws
	GA550	Galvanised steel rack 22x22x1000 module 4		GA557	Roger Technology nylon rack module 4 with 6 connectors L.1000
	GA551	Galvanised steel rack 30x12x1000 module 4 with spacers and screws		R99/C/001	Signboard "Automatic Opening"

STANDARD ACCESSORIES

Always included in the individual product package or kit

			BG30/1004/HS	BG30/1404/R	BG30/1604	BG30/1504/HS	BG30/1804/HS	BG30/2204
	KT215	Fixing plate with stay bolts and screws G30 series	✓	✓	✓	✓	✓	✓
	MC775	Kit magnetic limit switch for control unit H70/103AC, H70/104AC, B70/1DC, B70/1DCHP	✓	✓	✓	✓	✓	✓

STANDARD INSTALLATION

A PRACTICAL EXAMPLE FOR YOUR SUCCESSFUL INSTALLATION

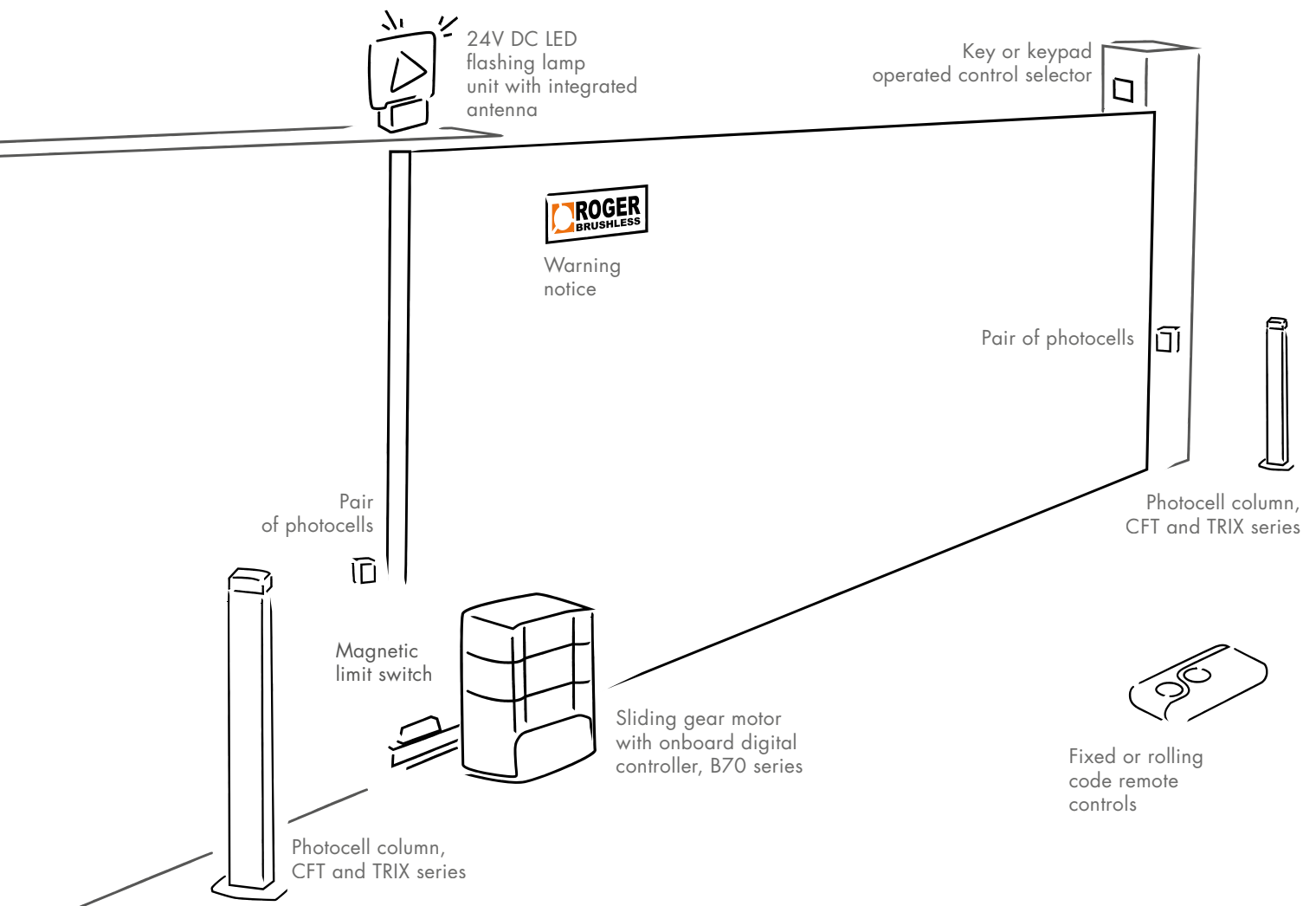



SLIDING GATE





PREMIUM DEALER / PROFESSIONAL DEALER



100% Made in Italy

Via S. Botticelli, 8
31021 Bonisiolo di Mogliano Veneto (TV) · ITALY
T. +39 041 5937023 · F. +39 041 5937024

WWW.ROGERTECHNOLOGY.COM



WWW.WEAREBRUSHLESS.COM