

# Solaris<sup>TM</sup> VISION

## Instruction and Reference Guide Embroidery

Model BLSA3



**baby lock**

**FOR THE LOVE OF SEWING**

To register your machine warranty and receive Baby Lock product updates and offers, go to [babylock.com/login](http://babylock.com/login). If you have questions with registration, visit your Authorized Baby Lock Retailer.

Baby Lock Consumer Helpline: 800-313-4110

[www.BabyLock.com](http://www.BabyLock.com)

Brought to You by Tacony Corporation®.



## HOW TO USE THIS MANUAL

The Instruction and Reference Guides for this machine consist of the Instruction and Reference Guide (Sewing) and the Instruction and Reference Guide (Embroidery). Refer to the appropriate Instruction and Reference Guide according to your needs. For basic information about, for example, the included accessories or the settings screen, refer to chapter 1 of the Instruction and Reference Guide (Sewing). In the screens appearing in the step-by-step instructions, the parts referred to in the operations are marked with . Compare the screen in the directions with the actual screen, and carry out the operation. If, while using the machine, you experience something you do not understand, or there is a function you would like to know more about, refer to the index at the back of the Instruction and Reference Guide in conjunction with the table of contents to find the section of the manual you should refer to.

# CONTENTS

**HOW TO USE THIS MANUAL** ..... 1

**Chapter 1 Embroidery Step by Step** ..... 5

**BEFORE EMBROIDERING** ..... 6

    Using the Machine Setting Mode Key ..... 7

    Embroidery Settings ..... 7

**CHANGING THE PRESSER FOOT** ..... 9

    Removing the Presser Foot ..... 9

    Attaching Embroidery Foot “W” ..... 10

**CHANGING THE NEEDLE**..... 11

**ATTACHING THE EMBROIDERY UNIT** ..... 13

    About the Embroidery Unit..... 13

    Attaching the Embroidery Unit ..... 13

    Removing the Embroidery Unit ..... 14

**LOWER THREADING**..... 15

    Winding the Bobbin ..... 15

    Setting the Bobbin ..... 19

**UPPER THREADING**..... 21

    Upper Threading ..... 21

    Using the Spool Stand ..... 24

**PREPARING THE FABRIC**..... 26

    Attaching Iron-On Stabilizers (Backing) to the Fabric..... 26

    Hooping the Fabric in the Embroidery Frame ..... 27

    Embroidering Small Fabrics or Fabric Edges ..... 31

**ATTACHING THE EMBROIDERY FRAME**..... 32

**EMBROIDERY SCREENS**..... 33

**KEY FUNCTIONS** ..... 35

    Editing Patterns..... 35

    Editing Letters ..... 37

    Embroidery Screen ..... 38

**SELECTING PATTERNS**..... 40

    Selecting Embroidery Patterns/Decorative Alphabet Patterns/  
    Utility Embroidery Patterns ..... 40

    Selecting Frame Patterns..... 41

**CONFIRMING THE PATTERN POSITION**..... 42

    Checking the Embroidery Pattern with the Projector ..... 42

    Checking the Needle Drop Point With the Projector ..... 43

    Aligning the Embroidering Position Using the Built-In  
    Camera ..... 43

    Using the Embroidery Position Sticker to Align the  
    Embroidering Position ..... 45

    Checking the Pattern Position ..... 47

**EMBROIDERING A PATTERN** ..... 49

    Embroidering Attractive Finishes ..... 49

    Embroidering Patterns ..... 50

**ADJUSTMENTS DURING THE EMBROIDERY  
PROCESS**..... 52

    If the Bobbin Runs out of Thread ..... 52

    If the Thread Breaks during Embroidering..... 53

    Restarting from the Beginning..... 54

    Resuming Embroidery after Turning Off the Power ..... 54

**IQ INTUITION- MONITORING APP** ..... 56

**Chapter 2 Basic Editing** ..... 57

**BASIC EDITING**..... 58

    Previewing the Pattern..... 58

    Moving the Pattern ..... 59

    Rotating the Pattern ..... 59

    Changing the Size of the Pattern..... 60

    Changing the Density ..... 61

    Creating a Horizontal Mirror Image..... 62

    Designing Repeated Patterns ..... 62

    Embroidering the Pattern Repeatedly..... 65

    Duplicating a Pattern..... 67

    Deleting the Pattern..... 68

    Displaying Patterns in the Screen Magnified..... 68

    Deselect Region Setting (No Sew Setting)..... 68

**EDITING LETTERS**..... 70

    Selecting Alphabet Character Patterns..... 70

    Character Alignment..... 71

    Changing Font Type..... 71

    Changing Letter Size ..... 72

    Changing the Configuration of Alphabet Character  
    Patterns..... 73

    Changing Alphabet Character Spacing..... 74

    Re-editing Character Patterns..... 75

**EDITING COLORS**..... 76

    Changing the Thread Color ..... 76

    Find New Color Schemes with the Color Visualizer  
    Function ..... 77

    Thread Color Sorting..... 79

**COMBINING PATTERNS** ..... 80

    Editing Combined Patterns ..... 80

    Selecting Multiple Patterns at the Same Time..... 83

    Grouping Multiple Selected Patterns..... 84

    Aligning the Embroidery Patterns ..... 84

**Chapter 3 Advanced Editing** ..... 85

**VARIOUS EMBROIDERING FUNCTIONS** ..... 86

    Uninterrupted Embroidering (Using a Single Color:  
    Monochrome) ..... 86

    Display the Fabric while Aligning the Embroidering  
    Position ..... 86

    Basting Embroidery ..... 90

    Changing the Embroidering Order of Combined Patterns..... 91

**MAKING EMBROIDERY ADJUSTMENTS**..... 92

    Adjusting Thread Tension ..... 92

    Adjusting the Alternate Bobbin Case (with No Color on the  
    Adjusting Screw) ..... 94

    Using the Automatic Thread Cutting Function (End Color  
    Trim)..... 95

    Using the Thread Trimming Function (Jump Stitch Trim)..... 96

    Adjusting the Embroidery Speed ..... 97

    Changing the Thread Color Display ..... 97

    Changing the Embroidery Frame Display ..... 97

    Aligning the Pattern and the Needle ..... 98

    Embroidering Linked Characters ..... 99

**USING THE MEMORY FUNCTION** ..... 101

    Saving Embroidery Patterns..... 101

    Retrieving Embroidery Patterns ..... 102

**EMBROIDERY APPLICATIONS** ..... 104

    Creating an Appliqué Piece ..... 104

    Using Appliqués ..... 108

    Using a Frame Pattern to Make an Appliqué (1) ..... 111

    Using a Frame Pattern to Make an Appliqué (2) ..... 112

    Embroidering Couching Patterns ..... 113

    Creating Stippling, Echo Quilting, or Decorative Fill Patterns  
    around a Design ..... 116

    Embroidering a Quilting Pattern Across the Entire Fabric  
    (Edge-to-Edge Quilt Function) ..... 117

    Embroidering Quilting Border Patterns (Auto Split Quilt  
    Sash)..... 123

    Embroidering Quilting Border Patterns (Semi-Auto Split Quilt  
    Sash)..... 126

    Hexagonal Quilting Borders ..... 131

    Embroidering Split Embroidery Patterns ..... 135

**USING THE CAMERA TO CONNECT  
PATTERNS**..... 140

    Connecting Three Patterns ..... 140

    Changing the Position of a Sticker..... 145

    Resume Feature ..... 147



<b>Chapter 4 IQ Designer</b>	<b>149</b>
<b>ABOUT IQ DESIGNER</b>	<b>150</b>
<b>PATTERN DRAWING SCREEN</b>	<b>150</b>
Before Creating Designs	152
Drawing Lines	152
Drawing Regions	154
Using the Stamp Key	156
Using the Erase Key	157
Using the Select Key	157
Using the Size Key	158
Importing Motif Stitch Pattern Data or Decorative Fill Pattern Data	159
<b>STITCH SETTINGS SCREEN</b>	<b>161</b>
Specifying Individual Stitch Settings	161
Specifying Global Stitch Settings	163
<b>IQ DESIGNER WITH SCAN</b>	<b>164</b>
Create the pattern using scanned images or image data files	164
Using the Scanning Frame	164
Scanning to Trace Background Image	165
Importing the Background Image	167
<b>LINE SCAN</b>	<b>169</b>
Using the Scanning Frame to Create a Pattern with Line Scan	169
<b>ILLUSTRATION SCAN</b>	<b>172</b>
Using the Scanning Frame to Create a Pattern with Illustration Scan	172
<b>STIPPLING</b>	<b>175</b>
Basic Stippling with IQ Designer	175
Scanning Drawing to Create Stippling Pattern	177
Scanning Fabric and Stippling	181
Decorative Stitching Around a Pattern in Embroidery (a Quilting Function)	185
<b>IQ INTUITION- POSITIONING APP</b>	<b>188</b>
<b>Chapter 5 Appendix</b>	<b>191</b>
<b>TROUBLESHOOTING</b>	<b>192</b>
If the Thread Becomes Tangled Under the Bobbin Winder Seat	192
List of Symptoms	193
<b>ERROR MESSAGES</b>	<b>198</b>
<b>INDEX</b>	<b>200</b>

1

2

3

4

5





Chapter *1*

# Embroidery Step by Step



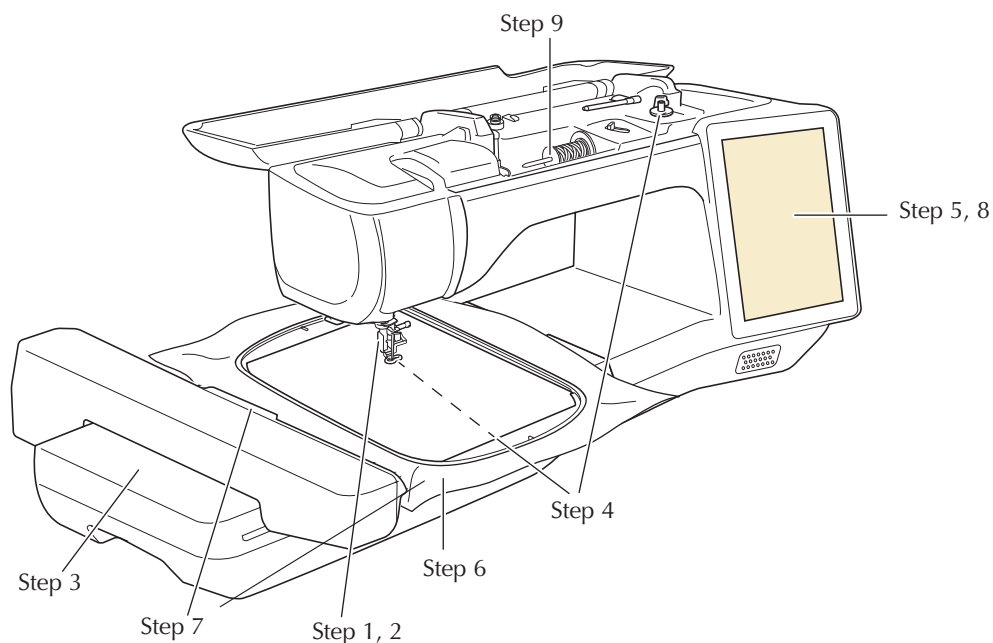

# BEFORE EMBROIDERING

Follow the steps below to prepare the machine for embroidery.



Step #	Aim	Action	Page
1	Presser foot attachment	Attach embroidery foot "W".	9
2	Checking the needle	Use needle 75/11 for embroidery.	11
3	Embroidery unit attachment	Attach the embroidery unit.	13
4	Bobbin thread setup	For the bobbin thread, wind embroidery bobbin thread and set it in place.	15
5	Pattern selection	Turn the main power to ON, and select an embroidery pattern.	33
6	Fabric preparation	Attach a stabilizer material to the fabric, and hoop it in the embroidery frame.	26
7	Embroidery frame attachment	Attach the embroidery frame to the embroidery unit.	32
8	Checking the layout	Check and adjust the size and position of the embroidery.	42
9	Embroidery thread setup	Set up embroidery thread according to the pattern.	21

## Using the Machine Setting Mode Key

Touch  to change the default machine settings (needle stop position, embroidery speed, opening display, etc.). To display the different settings screens, touch  for “Sewing settings”,  for “General settings”,  for “Embroidery settings” or  for “Wireless LAN settings”. For details on settings for sewing utility stitches, on common settings and on wireless settings, refer to the Instruction and Reference Guide (Sewing).

### Memo

- Touch  or  to display the previous or next page.

## Embroidery Settings

### ■ Page 8

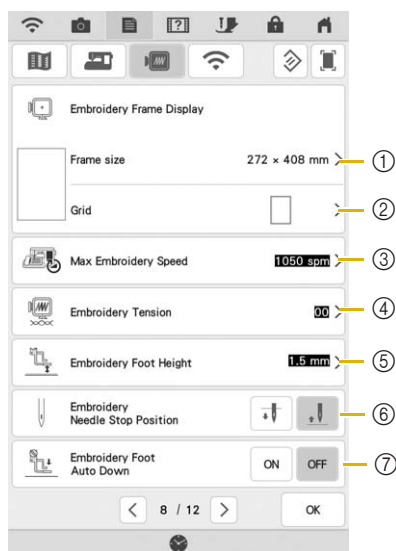

- ① Select the embroidery frame to be used. (page 97)
- ② Change the center point marker or grid lines. (page 97)
- ③ Adjust the maximum embroidery speed setting. (page 97)
- ④ Adjust the upper thread tension for embroidering. (page 93)
- ⑤ Select the height of the embroidery foot during embroidering.
- ⑥ Select the needle stop position for embroidering.
- ⑦ When set to [ON], pressing the “Start/Stop” button when the presser foot is raised automatically lowers the presser foot before starting embroidering.

### ■ Page 9

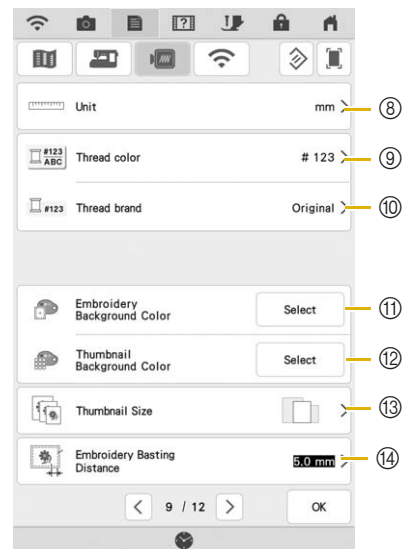

- ⑧ Change the display units (mm/inch).
- ⑨ Change the thread color display on the [Embroidery] screen: thread number or color name. (page 97)
- ⑩ Select the thread brand of the thread color display. The thread brand setting is reflected the next time a pattern is imported. (page 97)
- ⑪ Change the color of the background for the embroidery display area.
- ⑫ Change the color of the background for the thumbnail area.
- ⑬ Touch to specify the size of pattern thumbnails.
- ⑭ Adjust the distance between the pattern and the basting stitching. (page 90)

## ■ Page 10

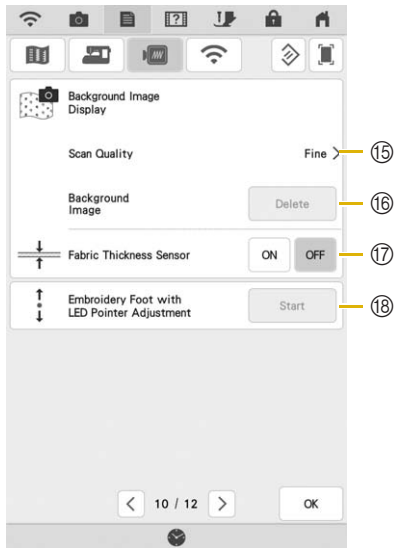



- ⑮ Select the quality for displaying the fabric in the screen. (page 88)
- ⑯ Erase the scanned image. (page 88)
- ⑰ When set to [ON], the built-in camera adjusts the display of the background image according to the thickness of the fabric. (page 89)
- ⑱ Adjust the position and brightness of the embroidery foot “W+” with LED pointer (sold separately). (These settings are not available unless embroidery foot “W+” with LED pointer is installed on the machine.)



# CHANGING THE PRESSER FOOT

## ⚠ CAUTION

- Always touch  on the screen to lock all keys and buttons before changing the presser foot. If  is not touched and the “Start/Stop” button or another button is pressed, the machine will start and may cause injury.

## IMPORTANT

- Use presser feet made for this machine.

### Removing the Presser Foot

- 1 Press the “Needle Position” button to raise the needle.

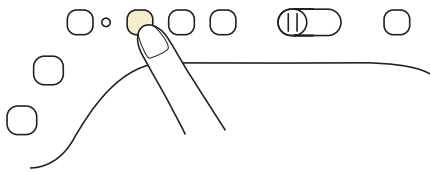

- 2 Touch  to lock all keys and buttons.

\* If the message [OK to automatically lower the presser foot?] appears on the LCD screen, touch

to continue.

- 3 Raise the presser foot lever.

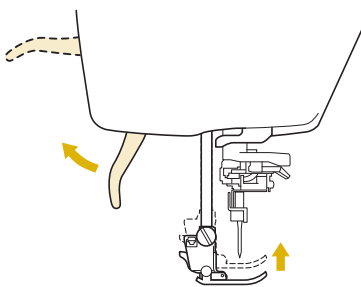

- 4 Press the black button on the presser foot holder and remove the presser foot.

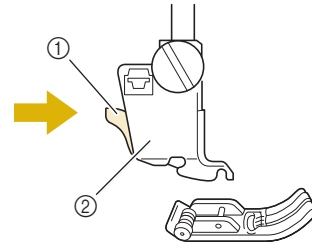

- ① Black button
- ② Presser foot holder

- 5 Loosen the screw of the presser foot holder to remove the presser foot holder.

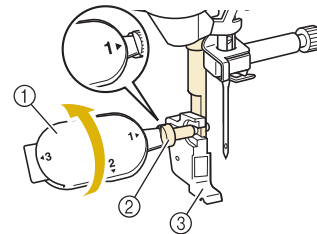

- ① Multi-purpose screwdriver
- ② Presser foot holder screw
- ③ Presser foot holder

## Attaching Embroidery Foot “W”

### ⚠ CAUTION

- When attaching an embroidery foot, always touch  on the screen. You may accidentally press the “Start/Stop” button and possibly cause injury.
- Be sure to use the embroidery foot “W” when doing embroidery. Using another embroidery foot may cause the needle to strike the embroidery foot, causing the needle to break and possibly causing injury.

- 1 Remove the presser foot and presser foot holder. For details, refer to “Removing the Presser Foot” on page 9.
- 2 Position the embroidery foot “W” on the presser foot bar by aligning the notch of the presser foot to the large screw.

Side view

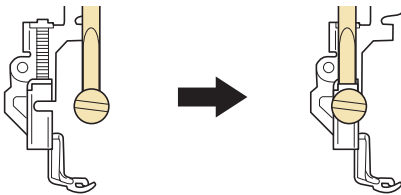

- 3 Hold the embroidery foot in place with your right hand, and then use the included multi-purpose screwdriver to securely tighten the presser foot holder screw.

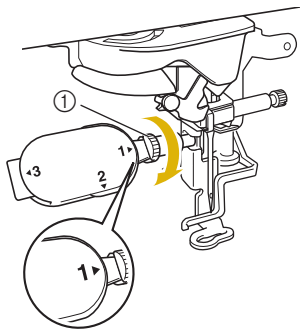

① Presser foot holder screw

### ⚠ CAUTION



- Use the included multi-purpose screwdriver to firmly tighten the screw of the presser foot holder. If the screw is loose, the needle may strike the embroidery foot and break, possibly cause injury.

- 4 Touch  to unlock all keys and buttons.

→ All keys and operation buttons are unlocked, and the previous screen is displayed.

# CHANGING THE NEEDLE

## ⚠ CAUTION

- Always touch  on the screen to lock all keys and buttons before changing the needle. If  is not touched and the “Start/Stop” button or another operation button is pressed accidentally, the machine will start and injury may result.
- Use only home sewing machine needles made for home use. Other needles may break and may cause injury.
- Never embroider with a bent needle. This may cause injury.

It is recommended to use a 75/11 home sewing machine needle. However, if the machine cannot make embroidery very well when embroidering on heavy weight fabric, please try a 90/14 needle. When embroidering patterns with short stitches, such as small letters, we recommend using a ball point needle for embroidery.

### 💡 Note

- To check the needle correctly, place the flat side of the needle on a flat surface. Check the needle from the top and the sides. Throw away any bent needles.

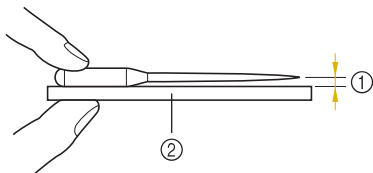

- ① Parallel space
- ② Level surface (bobbin cover, glass, etc.)

- The machine needles are consumables. Replace the needle in cases such as those described below.
  - If an unusual sound is produced when the needle enters the fabric. (The tip of the needle may be broken or dull.)
  - If stitches are skipped. (The needle may be bent.)

- 1** Press the “Needle Position” button to raise the needle.

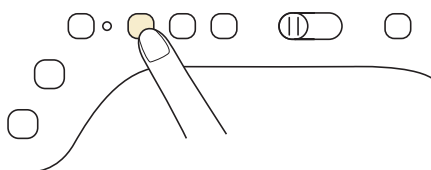

- 2** Touch  to lock all keys and buttons.

- \* If the message [OK to automatically lower the presser foot?] appears on the LCD screen, touch  to continue.

### 💡 Note

- Before replacing the needle, cover the hole in the needle plate with fabric or paper to prevent the needle from falling into the machine.

- 3** Remove the embroidery foot.

- 4** Use the multi-purpose screwdriver to turn the needle clamp screw toward the front of the machine and loosen the screw. Remove the needle.

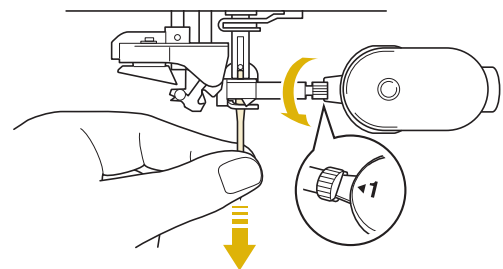

- 5** With the flat side of the needle facing the back, insert the new needle all the way to the top of the needle stopper (viewing window) in the needle clamp. Use the multi-purpose screwdriver to securely tighten the needle clamp screw.

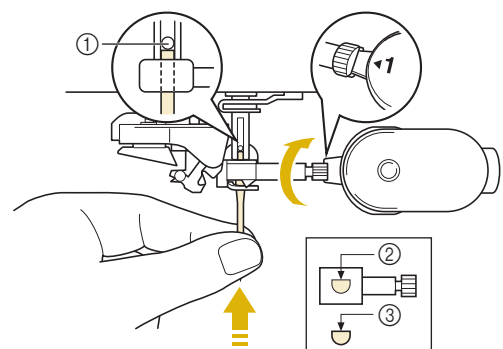

- ① Needle stopper
- ② Hole for setting the needle
- ③ Flat side of needle

## CAUTION

- Be sure to push in the needle until it touches the stopper, and securely tighten the needle clamp screw with a screwdriver. If the needle is not completely inserted or the needle clamp screw is loose, the needle may break and cause injury.

- 6 Attach the embroidery foot.
- 7 Touch  to unlock all keys and buttons.

# ATTACHING THE EMBROIDERY UNIT

## About the Embroidery Unit

### ⚠ CAUTION

- Do not move the machine with the embroidery unit attached. The embroidery unit could fall off and cause injury.



### IMPORTANT

- Keep your hands and foreign objects away from the embroidery carriage and frame when the machine is embroidering. Damage or malfunction may result.
- Be sure to turn off the power before attaching or removing the embroidery unit. Otherwise, the machine may be damaged.
- Do not touch the inner connector of the embroidery unit. The pins on the embroidery unit connection may be damaged.
- Do not apply strong force to the embroidery unit carriage or pick up the unit by the carriage. Otherwise, the embroidery unit may be damaged.
- Do not push on the carriage when attaching the embroidery unit onto the machine. Moving the carriage may damage the embroidery unit.
- Make sure that there is enough space for the carriage of the embroidery unit to move. If the embroidery frame comes into contact with an object, the pattern may not be embroidered correctly, or damage may result.
- Do not touch the embroidery carriage until the initialization finishes.

#### 💡 Note

- To avoid distorting your embroidery design, do not touch the embroidery carriage and frame when the machine is embroidering.
- Store the embroidery unit in a safe place to prevent damage to the unit.

#### 📝 Memo

- You can also sew utility/decorative stitches with the embroidery unit attached. Touch  and . The feed dog will automatically raise for utility and decorative stitching.

## Attaching the Embroidery Unit

- Turn the main power to OFF, and remove the flat bed attachment.

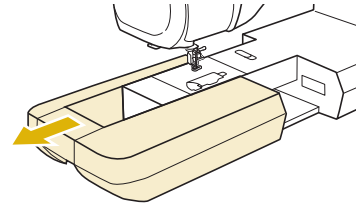

- Insert the embroidery unit connection into the connection port of the machine until it snaps into place.

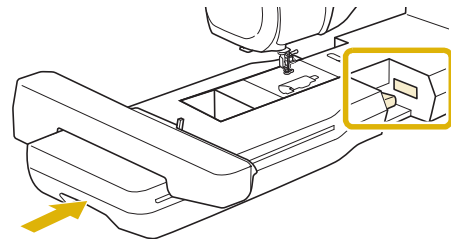

#### 💡 Note

- Be sure there is no gap between the embroidery unit and the machine. If there is a gap, the embroidery patterns will not embroider with the correct registration.

- Turn the main power to ON.

- Touch .

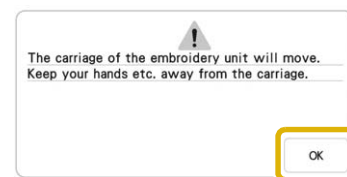



→ The carriage will move to the initialization position.

## Removing the Embroidery Unit

**1 Remove the embroidery frame.**

\* For details on removing the embroidery frame, refer to "Removing the Embroidery Frame" on page 32.

**2 Touch , then touch .**

→ The carriage will move to the removal position.

**3 Turn the main power to OFF.**

**4 Press the release button, and pull the embroidery unit away from the machine.**

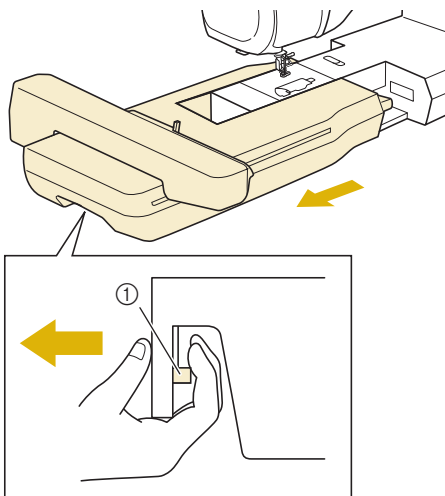

① Release button



# LOWER THREADING

## Winding the Bobbin

### IMPORTANT

- Use the plastic bobbins that came with this machine or bobbins of the same type: 11.5 mm (approx. 7/16 inch) plastic Class 15 (A style) bobbins, which are available from your Baby Lock retailer.

#### Memo

- For most embroidery applications, the bobbin should be wound with the included bobbin thread. See page 94 for more details regarding bobbin threads.

### Using the Supplemental Spool Pin

With this machine, you can wind the bobbin during embroidering. While the main spool pin is being used for embroidering, you can wind a bobbin by using the supplemental spool pin.

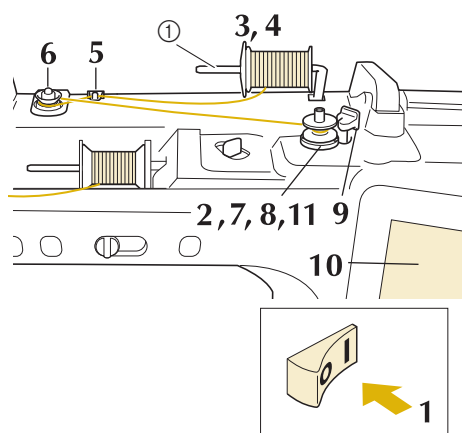

① Supplemental spool pin

- Turn the main power to ON and open the top cover.
- Align the groove in the bobbin with the spring on the bobbin winder shaft, and set the bobbin on the shaft.

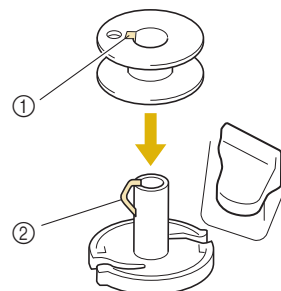

- Groove in the bobbin
- Spring on the shaft

- Set the supplemental spool pin in the "up" position.

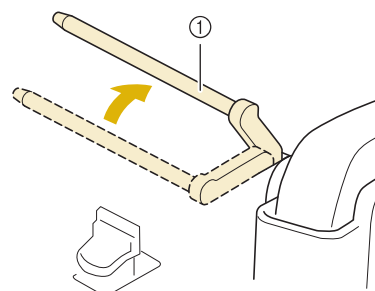

- Supplemental spool pin

- Place the spool of thread on the supplemental spool pin, so that thread unrolls from the front. Push the spool cap onto the spool pin as far as possible to secure the thread spool.

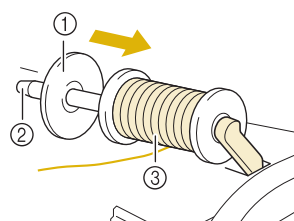

- Spool cap
- Spool pin
- Thread spool

1

Embroidery Step by Step

# IMPORTANT

- If the spool or the spool cap is not installed correctly, the thread may become tangled around the spool pin and the machine may be damaged.
- Three spool cap sizes are available, allowing you to choose a spool cap that best fits the size of spool being used. If the spool cap is too small for the spool being used, the thread may catch on the slit in the spool or the machine may be damaged. When using mini king thread spool, use the thread spool insert (mini king thread spool).  
For details on thread spool insert (mini king thread spool), refer to "Note" on page 16.



**Note**

- When using the spool as shown below, use the thread spool insert (mini king thread spool). Make sure that the thread spool insert is firmly inserted. After installing it, pull out some thread, and check that the thread unwinds without getting caught.

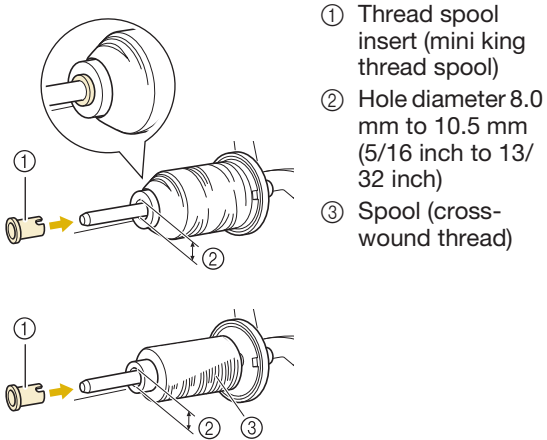

- ① Thread spool insert (mini king thread spool)
- ② Hole diameter 8.0 mm to 10.5 mm (5/16 inch to 13/32 inch)
- ③ Spool (cross-wound thread)

- 5 With your right hand, hold the thread near the thread spool. With your left hand, hold the end of the thread, and use both hands to pass the thread through the thread guide.

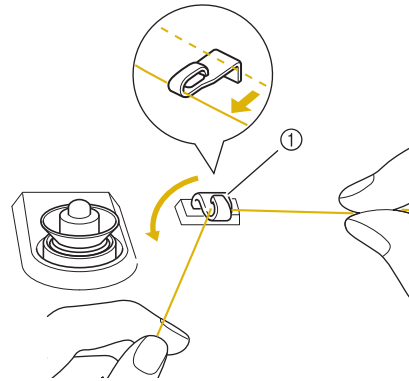

① Thread guide

- 6 Pass the thread around the pretension disk making sure that the thread is under the pretension disk.

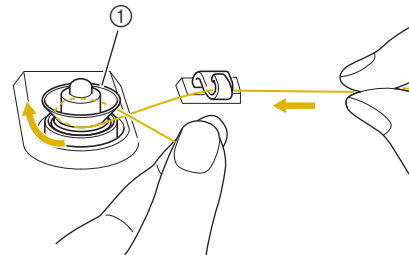

① Pretension disk  
→ Make sure that the thread passes under the pretension disk.

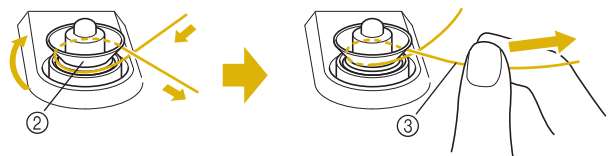

② Pretension disk  
③ Pull it in as far as possible.  
→ Check to make sure thread is securely set between pretension disks.

- 7 Wind the thread clockwise around the bobbin 5-6 times.

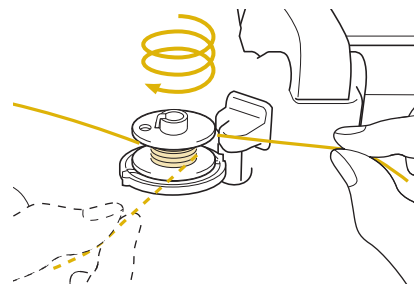

- 8** Pass the end of the thread through the guide slit in the bobbin winder seat, and pull the thread to the right to cut the thread with the cutter.

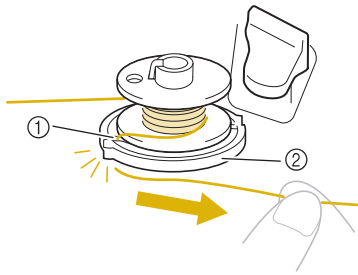

- ① Guide slit (with built-in cutter)
- ② Bobbin winder seat

## CAUTION

- Be sure to follow the process described. Winding the bobbin without cutting the thread with the cutter may cause the bobbin to be wound incorrectly. In addition, the thread may become tangled around the bobbin when the bobbin thread starts to run out, possibly causing the needle to break, resulting in injuries.

- 9** Set the bobbin winding switch to the left, until it clicks into place.

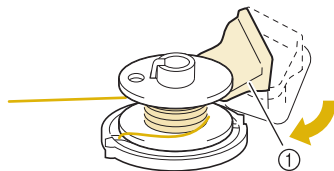

- ① Bobbin winding switch

### Memo

- Use the bobbin winding slider to adjust the amount of thread wound onto the bobbin to one of five levels.

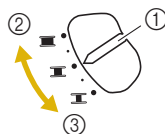

- ① Bobbin winding slider
- ② More
- ③ Less

→ The bobbin winding window appears.

- 10** Touch .

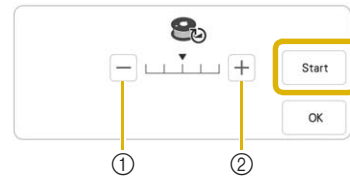

- ① Touch to decrease the winding speed
- ② Touch to increase the winding speed

→ Bobbin winding starts.  changes to  while the bobbin is winding. The bobbin stops rotating when bobbin winding is completed. The bobbin winding switch will automatically return to its original position.

### Memo

- Stay near the machine while winding the bobbin to make sure the bobbin thread is being wound correctly. If the bobbin thread is wound incorrectly, touch .
- Touch  to minimize the bobbin winding window. Then, you can perform other operations, such as selecting a pattern or adjusting the thread tension, while the bobbin is being wound.
- Touch  (in top right of the LCD screen) to display the bobbin winding window again.



- 11** After bobbin winding is finished, cut the thread and remove the bobbin.

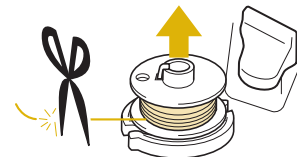

## IMPORTANT

- When removing the bobbin, do not pull on the bobbin winder seat. Doing so could loosen or remove the bobbin winder seat, and could result in damage to the machine.

### ■ If the Thread Becomes Tangled Under the Bobbin Winder Seat

Refer to “If the Thread Becomes Tangled Under the Bobbin Winder Seat” on page 192.

## Using the Spool Pin

You can use the main spool pin to wind the bobbin before embroidering. You cannot use this spool pin to wind the bobbin while embroidering.

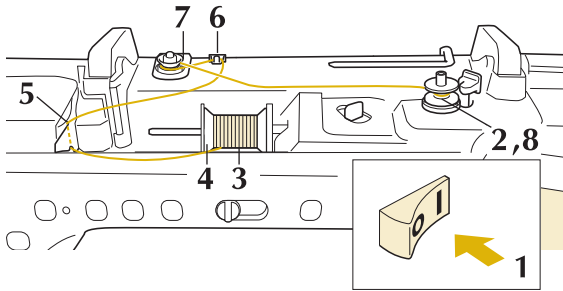

**1** Turn the main power to ON and open the top cover.

**2** Align the groove in the bobbin with the spring on the bobbin winder shaft, and set the bobbin on the shaft.

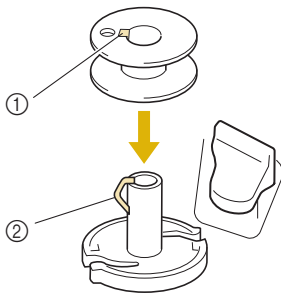

- ① Groove in the bobbin
- ② Spring on the shaft

**3** Pivot the spool pin so that it angles upward. Set the thread spool on the spool pin so that the thread unwinds from the front of the spool.

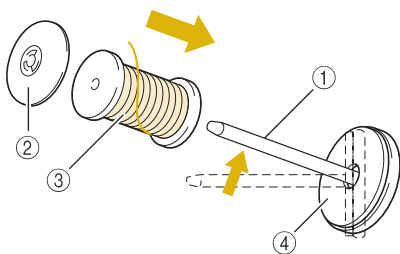

- ① Spool pin
- ② Spool cap
- ③ Thread spool
- ④ Spool felt

**4** Push the spool cap onto the spool pin as far as possible, then return the spool pin to its original position.

**5** While holding the thread with both hands, pull the thread up from under the thread guide plate.

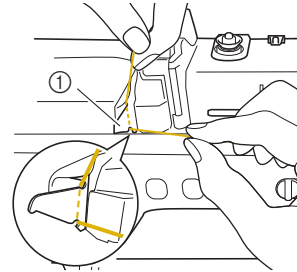

- ① Thread guide plate

**6** Pass the thread through the thread guide.

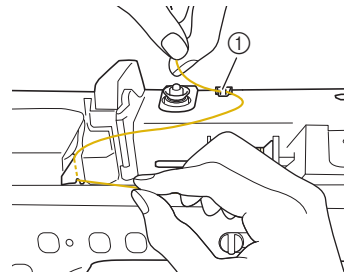

- ① Thread guide

**7** Pass the thread around the pretension disk making sure that the thread is under the pretension disk.

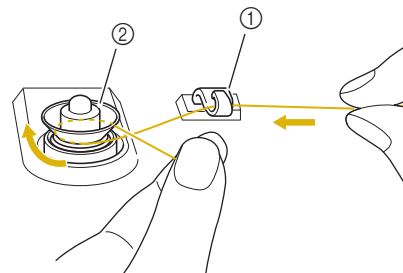

- ① Thread guide
- ② Pretension disk

**8** Follow steps **7** through **11** on page 16 through 17.

## ■ Using the Spool Stand

To wind thread on the bobbin while the spool stand is installed, pass the thread from the spool through the thread guide on the telescopic thread guide, and then wind the bobbin according to steps 5 through 11 of “Using the Supplemental Spool Pin” on page 16 to page 17.

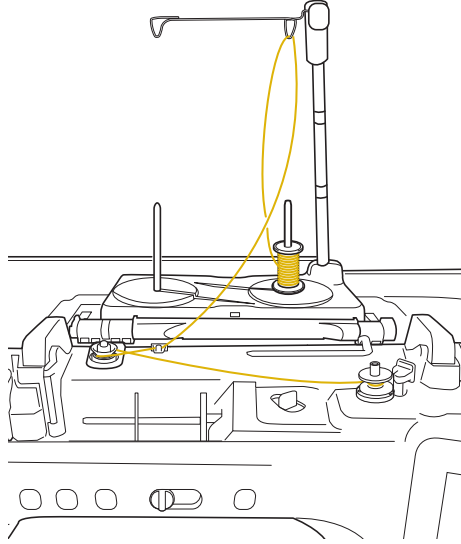

### 📖 Memo

- Refer to the Instruction and Reference Guide (Sewing) to assemble the spool stand.
- Refer to page 24 to thread the machine using the spool stand.

## IMPORTANT

- When winding thread on the bobbin, do not cross the bobbin winding thread with the upper thread in the thread guides.

## Setting the Bobbin

Install the bobbin wound with thread.

### ⚠ CAUTION

- Use a bobbin thread that has been correctly wound. Otherwise, the thread tension may be incorrect and the needle may break, causing injuries.

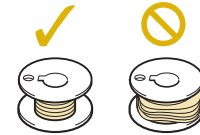

- Before inserting or changing the bobbin, be sure to touch  in the LCD to lock all keys and buttons, otherwise injuries may occur if the “Start/Stop” button or any other button is pressed and the machine starts embroidering.

- 1 Touch  to lock all keys and buttons and raise the presser foot.

\* If the message [OK to automatically lower the presser foot?] appears on the LCD screen, touch

to continue.

- 2 Slide the bobbin cover latch to the right.

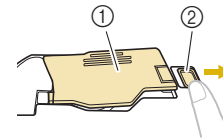

① Bobbin cover

② Latch

→ The bobbin cover opens.

- 3 Remove the bobbin cover.

- 4 Hold the bobbin with your right hand and hold the end of the thread with your left hand.

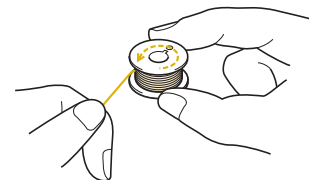

- 5** Set the bobbin in the bobbin case so that the thread unwinds to the left.

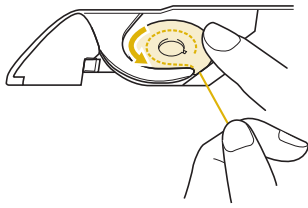

**Note**

- Be sure to hold down the bobbin with your finger and unwind the bobbin thread correctly. Otherwise, the thread may break or the thread tension will be incorrect.

- 6** Lightly hold down the bobbin with your right hand, and then guide the end of the thread around the tab of the needle plate with your left hand.

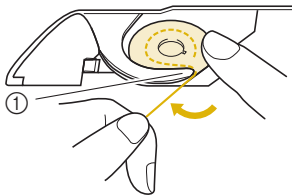

① Tab

- 7** While lightly holding down the bobbin with your right hand, guide the thread through the slit in the needle plate and lightly pull it with your left hand.

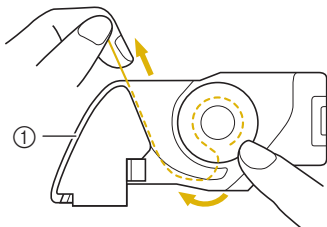

① Slit

**Memo**

- By pulling the thread as shown in step **7**, the thread will enter the tension spring of the bobbin case. The spring will apply the appropriate tension to the bobbin thread during embroidery.

- 8** While lightly holding down the bobbin with your right hand, continue guiding the thread through the slit with your left hand. Then, cut the thread with the cutter.

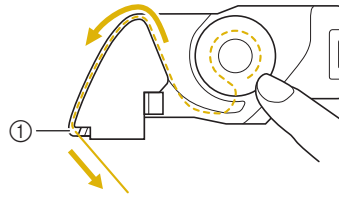

① Cutter

→ The cutter cuts the thread.

- 9** Insert the tab in the lower-left corner of the bobbin cover (1), and then lightly press down on the right side to close the cover (2).

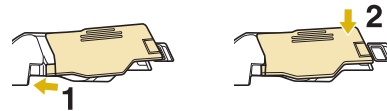

- 10** Touch  to unlock all keys and buttons.

**Memo**

- You can begin embroidering without pulling up the bobbin thread. If you wish to pull up the bobbin thread before starting to embroider, hold onto the upper thread tail, press the “Needle Position” button twice, then pull up the bobbin thread tail. Position both threads under the embroidery foot, pull out 10 cm (4 inches) of both threads, hold threads to the side, begin embroidering, pause, trim threads if desired, then continue embroidering.



# UPPER THREADING

## Upper Threading

**⚠ CAUTION**

- Be sure to thread the machine properly. Improper threading can cause the thread to tangle and break the needle, leading to injury.

**Memo**

- The automatic threading function can be used with home sewing machine needle sizes 75/11 through 100/16.
- When threads such as metallic thread or specialty threads are used, it is not recommended to use the needle threader.
- For most embroidery applications, the upper thread should be 40-weight rayon or polyester embroidery thread.

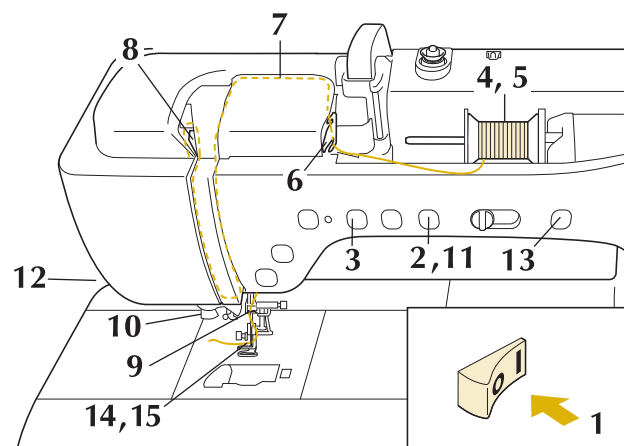

- 1 Turn the main power to ON.
- 2 Press the "Presser Foot Lifter" button to raise the embroidery foot.

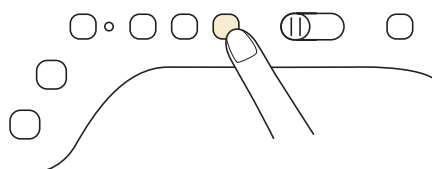

→ The upper thread shutter opens so the machine can be threaded.

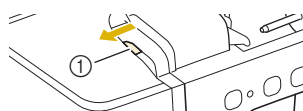

① Upper thread shutter

- 3 Press the "Needle Position" button to raise the needle.

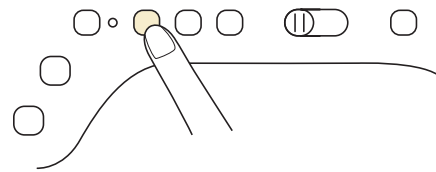

**IMPORTANT**

- Be sure to raise the needle before using the automatic needle threader. Otherwise, the needle may not thread correctly and the needle threader may be damaged.

- 4 Pivot the spool pin so that it angles upward. Set the thread spool on the spool pin so that the thread unwinds from the front of the spool.

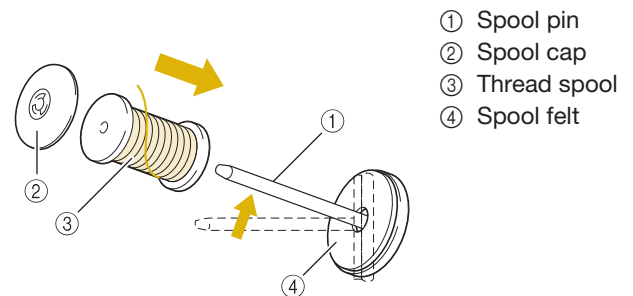

- ① Spool pin
- ② Spool cap
- ③ Thread spool
- ④ Spool felt

- 5 Push the spool cap onto the spool pin as far as possible, then return the spool pin to its original position.

**⚠ CAUTION**

- Choose a spool cap that best fits the size of spool being used. For more information regarding the choice of spool caps for your thread choice, refer to "Note" on page 16.

If the spool or the spool cap is not positioned correctly, the thread may become tangled around the spool pin, possibly causing the needle to break, resulting in injuries.

**Note**

- When using thread that winds off quickly, such as metallic thread, place the spool net over the spool before placing the spool of thread onto the spool pin. If the spool net is too long, fold it to fit the size of the spool.

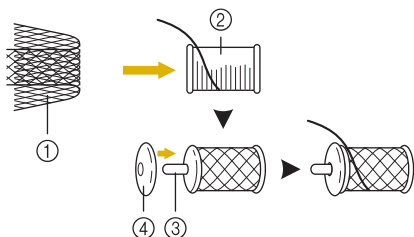

- ① Spool net
- ② Thread spool
- ③ Spool pin
- ④ Spool cap

- \* When threading the spool with the spool net on, make sure that 5-6cm (approx. 2 - 2-1/2 inches) of thread is pulled out.
- \* It may be necessary to adjust the thread tension when using the spool net.

**6** While holding the thread with both hands, pull the thread up from under the thread guide plate.

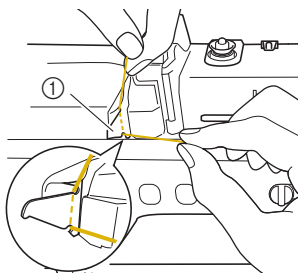

① Thread guide plate

**7** While holding the thread in your right hand, pass the thread through the thread guide in the direction indicated.

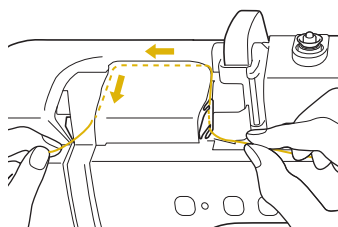

**8** Guide the thread down, up, then down through the groove, as shown in the illustration.

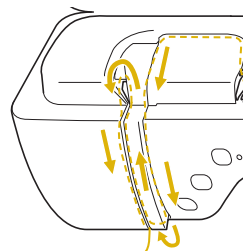

**Memo**

- Look in the upper groove area to check if the thread catches on the thread take-up lever visible inside the upper groove area.

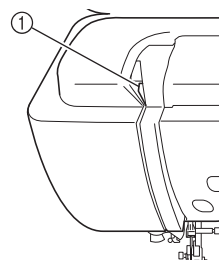

① Look in the upper groove area

**9** Pass the thread through the needle bar thread guide (marked "6") by holding the thread with both hands and guiding it as shown in the illustration.

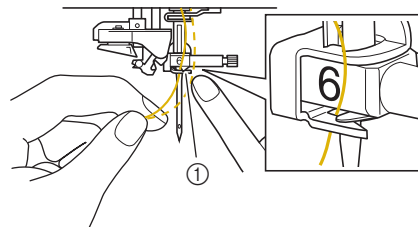

① Needle bar thread guide

**10** Pass the thread through the thread guide disks (marked "7"). Make sure that the thread passes through the groove in the thread guide.

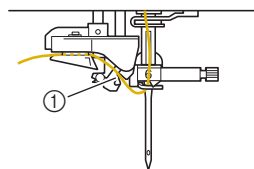

① Groove in thread guide

- 11** Press the “Presser Foot Lifter” button to lower embroidery foot.

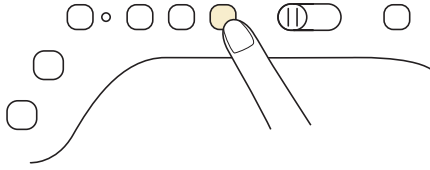

- 12** Pull the thread up through the thread cutter to cut the thread, as shown in the illustration.

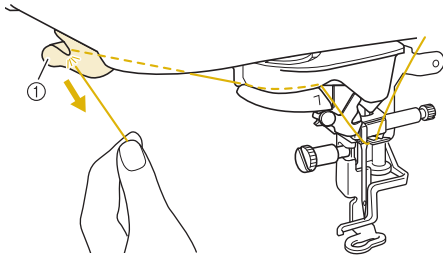

① Thread cutter

**Note**

- When using thread that quickly winds off the spool, such as metallic thread, it may be difficult to thread the needle if the thread is cut. Therefore, instead of using the thread cutter, pull out about 80 mm (approx. 3 inches) of thread after passing it through the thread guide disks (marked “7”).

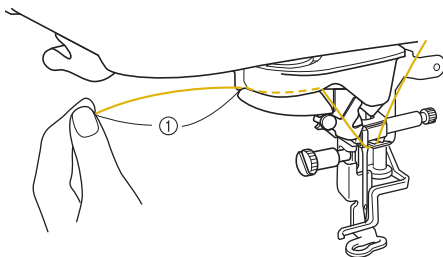

① 80 mm (approx. 3 inches) or more

- 13** Press the “Automatic Threading” button to have the machine automatically thread the needle.

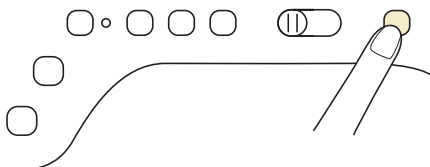

→ The thread passes through the eye of the needle.

**Memo**

- When the “Automatic Threading” button is pressed, the embroidery foot will be automatically lowered. After threading is finished, the embroidery foot moves back to the position before the “Automatic Threading” button was pressed.

- 14** Carefully pull the end of the thread that was passed through the eye of the needle.

- \* If a loop was formed when the thread passed through the eye of the needle, carefully pull the loop of thread through the eye to the back of the needle.

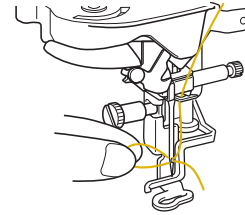

- 15** Pull out about 10 cm (approx. 4 inches) of the thread, and then pass it under the embroidery foot toward the rear of the machine.

- Raise the presser foot lever if the embroidery foot is lowered.

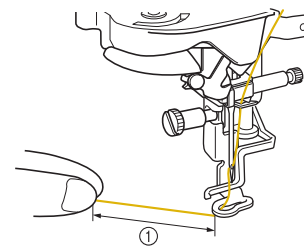

① About 10 cm (approx. 4 inches)

**Memo**

- If the needle could not be threaded or the thread was not passed through the needle bar thread guide, perform the procedure again starting from step 3.

**Note**

- Some needles cannot be threaded with the needle threader. In this case, instead of using the needle threader after passing the thread through the needle bar thread guide (marked “6”), manually pass the thread through the eye of the needle from the front.

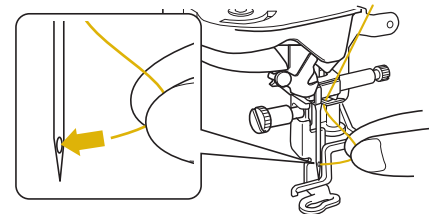

## Using the Spool Stand

The included spool stand is useful when using thread on spools with a large diameter (cross-wound thread). This spool stand can hold two spools of thread.

### Memo

- Refer to the Instruction and Reference Guide (Sewing) to assemble the spool stand.
  - Refer to page 19 to wind the bobbin when using the spool stand.
- 
- Be sure to use a spool cap that is slightly larger than the spool.  
If the spool cap that is used is smaller or much larger than the spool, the thread may catch and embroidering performance may suffer.

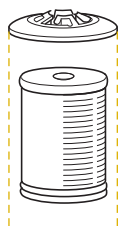

- When using thread on a thin spool, place the included spool felt on the spool pin, place the thread spool on the spool pin so that the center of the spool is aligned with the hole at the center of the spool felt, and then insert the spool cap onto the spool pin.

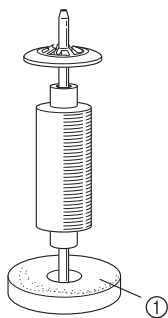

① Spool felt

- When using thread on a cone spool, use the spool holder. When using cone shaped thread spool with other than cotton thread, it is not necessary to use spool caps.

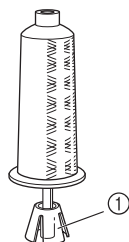

① Spool holder

- Depending on the size of spool or the amount of thread remaining, choose the appropriate sized spool cap (large or medium). Spool cap (small) cannot be used with the spool cap base.

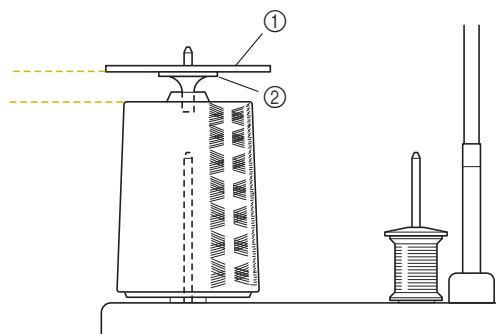

- ① Spool cap
- ② Spool cap base

### Attach the spool stand to the machine.

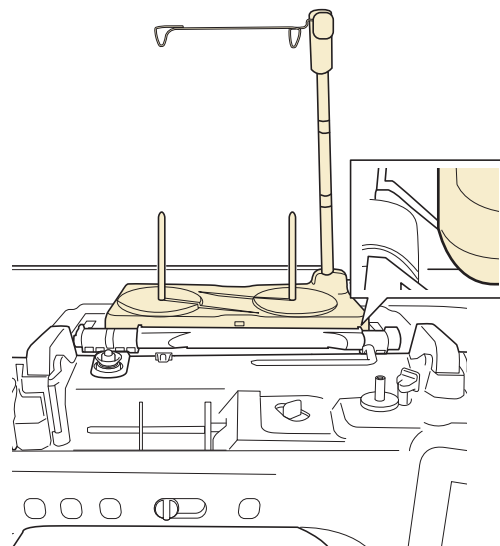

- 2** Place the spool of thread on the spool pin so that the thread feeds off the spool clockwise. Firmly insert the spool cap onto the spool pin.

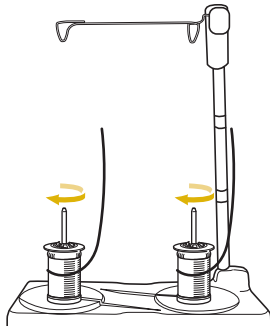

## ⚠ CAUTION

- Make sure that the spools do not touch each other, otherwise the thread will not feed off smoothly, and the needle may break and cause injury. In addition, make sure that the spools do not touch the telescopic thread guide at the center.

### 💡 Note

- When using 2 spools of thread, make sure that both spools are feeding in the same direction.
- Make sure that the thread is not caught under the spool.

- 3** Pull the thread off the spool. Pass the thread from the back to the front through the thread guides at the top.

When using thread that quickly feeds off the spool, such as metallic thread, use the enclosed ring to prevent the thread from becoming entangled. Threading sequence: Pull the thread from the spool, place the thread through the ring from the bottom up (❶), into the thread guide (❷) and through the ring from the top down (❸). When using the ring, do not use the spool cap base.

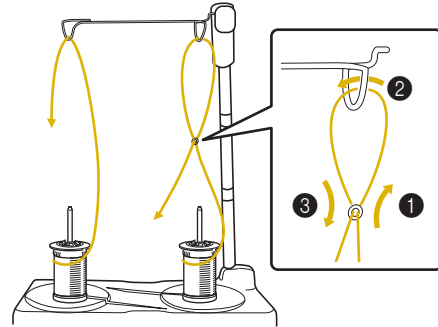

### 💡 Note

- Guide the thread so that it does not become entangled with the other thread.
- After feeding the thread as instructed, wind any excess thread back onto the spool, otherwise the excess thread will become tangled.

- 4** Pass the thread through the machine's thread guide from the right to the left.

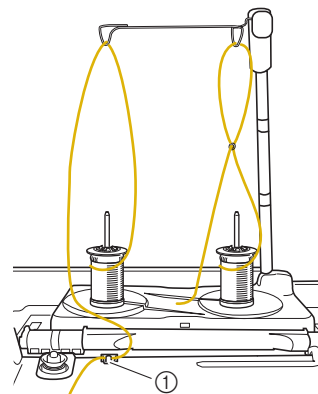

❶ Thread guide

- 5** Thread the machine according to the steps 6 to 15 of "Upper Threading" on page 21.

# PREPARING THE FABRIC

## ⚠ CAUTION

- Use fabrics with a thickness of less than 2 mm (approx. 1/16 inch). Using fabrics thicker than 2 mm (approx. 1/16 inch) may cause the needle to break and cause injury.

### 📝 Memo

- When embroidering fabric layers filled with thick batting, for example, a better result can be achieved by adjusting the embroidery foot height in the embroidery settings screen.

Touch , and select page 8. Touch the number beside [Embroidery Foot Height] in the embroidery settings screen. Adjust the embroidery foot height for thick or puffy fabrics.



- To increase the space between the embroidery foot and the needle plate, set the [Embroidery Foot Height] to a larger number.
- In the case of thick terry cloth towels, we recommend that you place a piece of water soluble stabilizer on the top surface of the towel. This will help to reduce the nap of the toweling and result in more attractive embroidery.

## Attaching Iron-On Stabilizers (Backing) to the Fabric

## ⚠ CAUTION

- Always use a stabilizer material for embroidery when embroidering stretch fabrics, lightweight fabrics, fabrics with a coarse weave, or fabrics which cause pattern shrinkage. Otherwise, the needle may break and cause injury. Not using a stabilizer material may result in a poor finish to your project.

- 1 Use a piece of stabilizer which is larger than the embroidery frame being used.

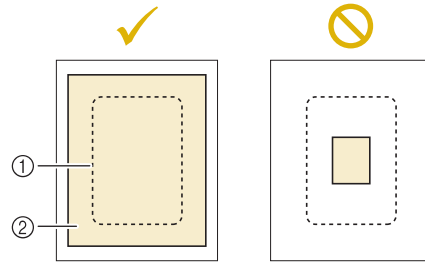

- ① Size of the embroidery frame
- ② Iron-on stabilizer (backing)

- 2 Iron the iron-on stabilizer material to the wrong side of the fabric.

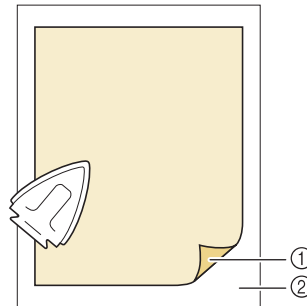

- ① Fusible side of stabilizer
- ② Fabric (wrong side)



### 📝 Memo

- When embroidering on thin fabrics such as organdy or lawn, or on napped fabrics such as towel or corduroy, use water soluble stabilizer (sold separately) for best results. The water soluble stabilizer material will dissolve completely in water, giving the project a more attractive finish.

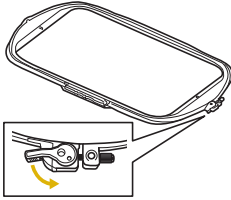
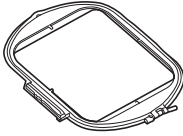

# Hooping the Fabric in the Embroidery Frame

## Types of Embroidery Frames

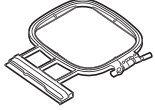
			
Embroidery field 408 mm × 272 mm (approx. 16 inches × 10-5/8 inches)	(Sold separately) Embroidery field 240 mm × 240 mm (approx. 9-1/2 inches × 9-1/2 inches)	Embroidery field 180 mm × 130 mm (approx. 7 inches × 5 inches)	Embroidery field 100 mm × 100 mm (approx. 4 inches × 4 inches)

When choosing frames that do not appear on the screen, be sure to check the design size of the embroidery field of the frame. Check with your authorized Baby Lock retailer for frame compatibility. Select a frame that matches the pattern size.

- ① Highlighted: Can be used
- ② Shaded: Cannot be used

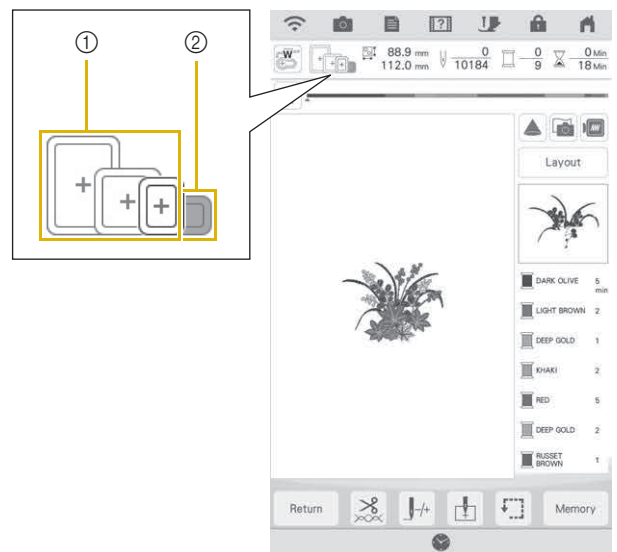

### Note

- To determine if the selected design will fit into a specific embroidery frame, please compare the dimensions of the design (shown at the top of the pattern selection screen or embroidery screen) to the dimensions of the frame's embroidery area. The actual embroidery area is smaller than the frame opening. All available frames which can be used with this machine are listed on page 8 of the Settings screen (by actual embroidery area dimensions). The included 272 mm x 272 mm frame has its embroidery field dimensions etched onto the bottom of the inner frame.

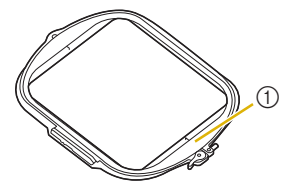
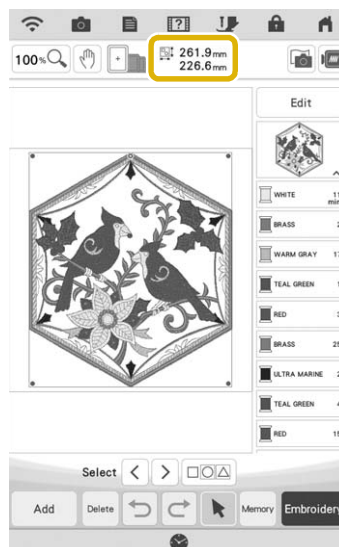
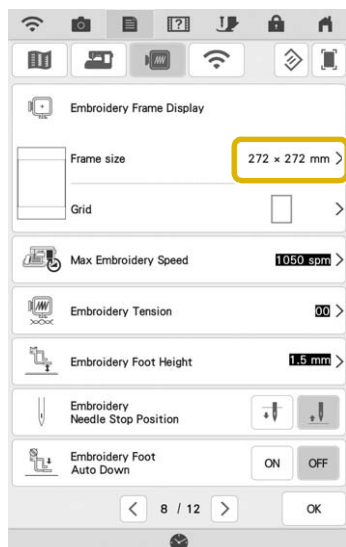

① 272 mm × 272 mm 10-5/8" × 10-5/8"

## ■ Inserting the Fabric

### 💡 Note

- If the fabric is not securely held in the embroidery frame, the embroidery design will embroider out poorly. Insert the fabric on a level surface, and gently stretch the fabric taut in the frame. Follow the steps below to insert the fabric correctly.

- 1** Lift-up and loosen the frame adjustment screw and remove the inner frame.

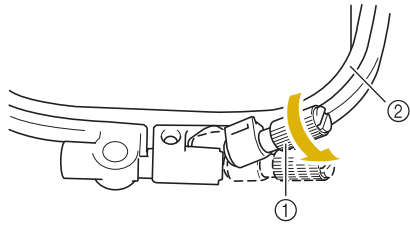

- ① Frame adjustment screw
- ② Inner frame

- 2** Lay the fabric right side up on top of the outer frame.

- 3** Re-insert the inner frame making sure to align the inner frame's  $\triangle$  with the outer frame's  $\nabla$ .

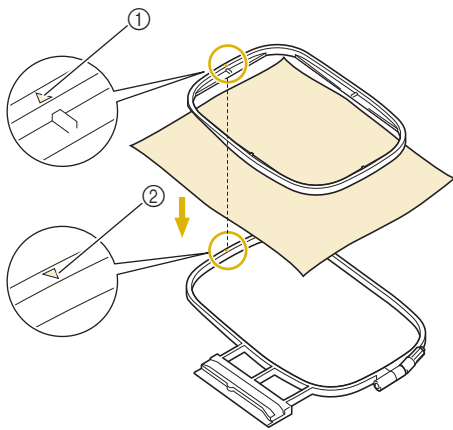

- ① Inner frame's  $\triangle$
- ② Outer frame's  $\nabla$

- 4** Slightly tighten the frame adjustment screw, and then remove the slack in the fabric by pulling on the edges and corners.

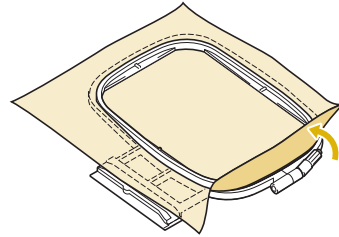

- 5** Gently smooth out the fabric. Make sure fabric is flat and without wrinkles.

\* After stretching the fabric, make sure the fabric is taut.

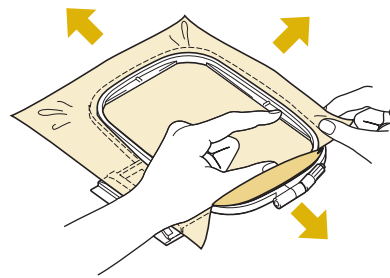

\* Make sure the inside and outside frames are even before you start embroidering.

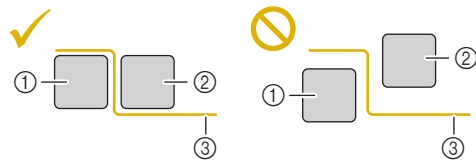

- ① Outer frame
- ② Inner frame
- ③ Fabric

- 6** Tighten the frame adjustment screw.

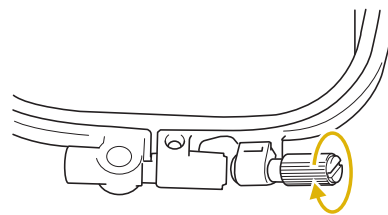

- 7** Return the frame adjustment screw to its initial position.

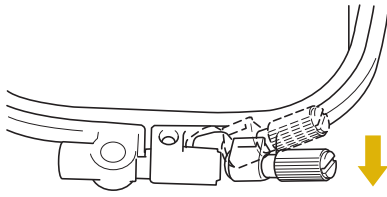

**Memo**

- You can use the included multi-purpose screwdriver, setting the position to “3”, when you loosen or tighten the frame adjustment screw.

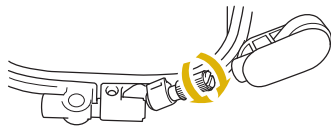

**■ Inserting Fabric into Embroidery Frame (Only Embroidery Frames with a Lever)**

- 1** Lower the lever.

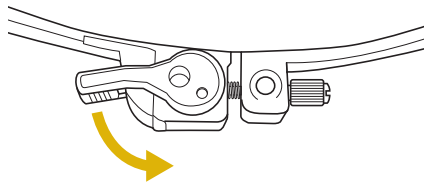

- 2** Loosen the frame adjustment screw by hand, and then remove the inner frame.

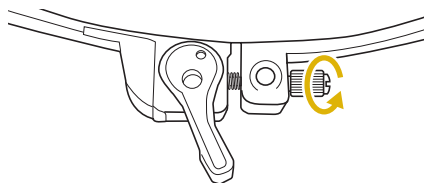

- 3** Refer to steps **3** through **6** of “Inserting the Fabric” on page 28 to hoop the fabric.

- 4** Tighten the frame adjustment screw by hand.

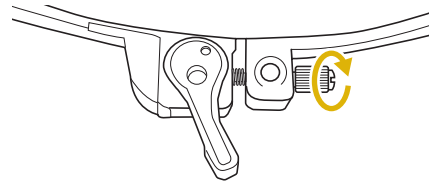

**Note**

- Do not overtighten the screw.

- 5** Return the lever to its original position.

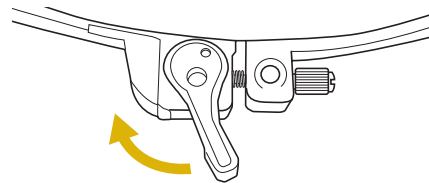

**■ Using the Embroidery Sheet (Sold Separately)**

When you want to embroider the pattern in a particular place, use the embroidery sheet with the frame.

- 1** With a chalk pencil, mark the area of the fabric you want to embroider.

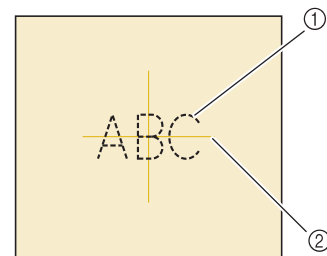

- ① Embroidery pattern
- ② Mark

- 2** Place the embroidery sheet on the inner frame. Align the guide lines on the embroidery sheet with the mark you made on the fabric.

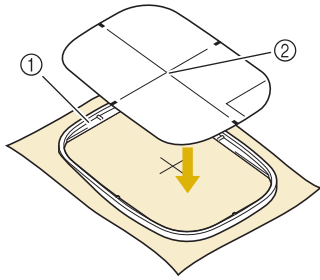

- ① Inner frame
- ② Guide line

- 3** Gently stretch the fabric so there are no folds or wrinkles, and press the inner frame into the outer frame.

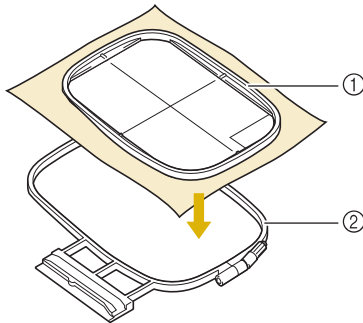

- ① Inner frame
- ② Outer frame

- 4** Remove the embroidery sheet.

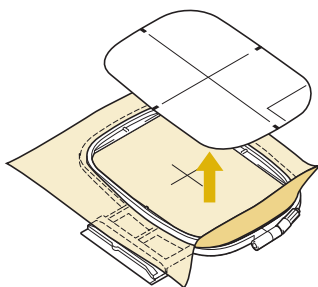

## Embroidery Needle Plate Cover

Under some conditions, based on the type of fabric, stabilizer, or thread being used, there may be some looping in the upper thread. In this case, attach the included embroidery needle plate cover to the needle plate. Attach the cover by inserting the two projections on the underside of the cover into the notches on the needle plate as shown below.

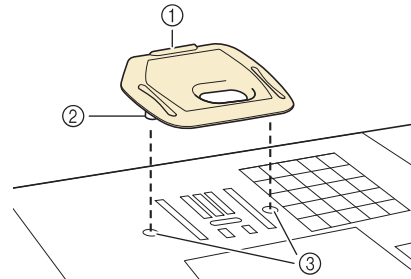

- ① Groove
- ② Projection
- ③ Notch

To remove the embroidery needle plate cover, place your fingernail in the groove and lift the plate out.

### **⚠ CAUTION**

- Push the embroidery needle plate cover as far as possible to attach it. If the embroidery needle plate cover is not securely attached, it may cause the needle to break and cause injury.

#### **💡 Note**

- Do not use the embroidery needle plate cover for any applications other than embroidery.

## Embroidering Small Fabrics or Fabric Edges

Use an embroidery stabilizer to provide extra support. We recommend using a stabilizer for all embroidery. After embroidering, remove the stabilizer carefully. Attach the stabilizer as shown in the following examples.

### Embroidering Small Fabrics

Use a temporary spray adhesive to adhere the small piece of fabric to the larger piece in the frame. If you do not wish to use a temporary spray adhesive, attach the stabilizer with a basting stitch.

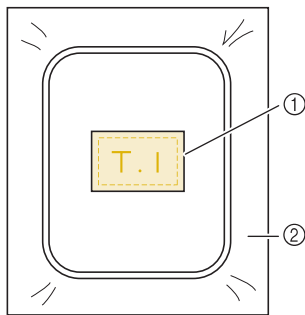

- ① Fabric
- ② Stabilizer

### Embroidering Edges or Corners

Use temporary spray adhesive to attach the fabric to the stabilizer, and then hoop the fabric. If you do not wish to use a temporary spray adhesive, attach the stabilizer with a basting stitch.

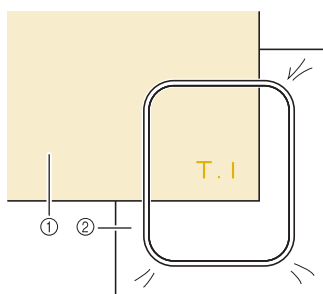

- ① Fabric
- ② Stabilizer

## Embroidering Ribbons or Tape

Secure with double-sided tape or a temporary spray adhesive.

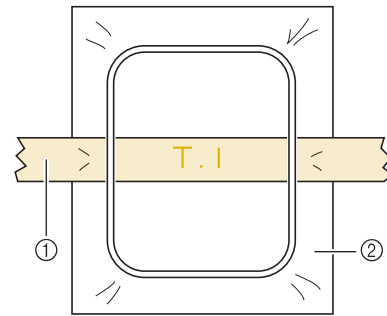

- ① Ribbon or tape
- ② Stabilizer

# ATTACHING THE EMBROIDERY FRAME

## Note

- Wind embroidery bobbin thread and insert the bobbin before attaching the embroidery frame. Check that there is enough thread in the bobbin.
- Make sure that the frame-securing lever is correctly lowered after the embroidery frame has been installed in the embroidery frame holder.

- 1 Press the “Presser Foot Lifter” button to raise the embroidery foot.

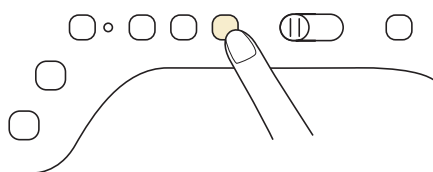

- 2 Align the embroidery frame guide with the right edge of the embroidery frame holder.

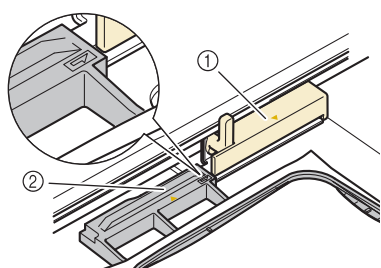

- ① Embroidery frame holder
- ② Embroidery frame guide

- 3 Slide the embroidery frame into the holder, making sure to align the embroidery frame's  $\triangle$  with the holder's  $\nabla$ .

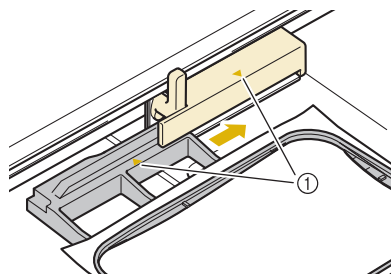

- ① Arrow mark

- 4 Lower the frame-securing lever to be level with the frame to secure the embroidery frame in the embroidery frame holder.

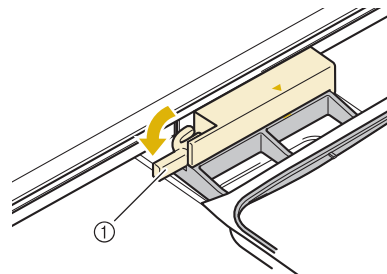

- ① Frame-securing lever

## Removing the Embroidery Frame

- 1 Raise the frame-securing lever.

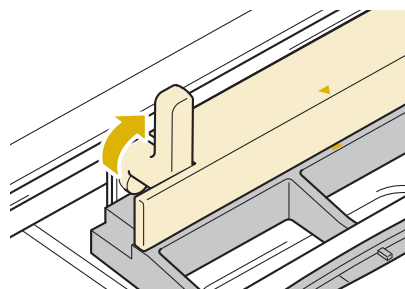

- 2 Pull the embroidery frame toward you.

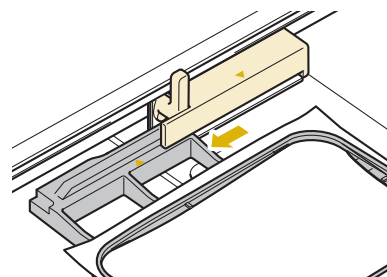

# EMBROIDERY SCREENS

## ■ Copyright Information

The patterns stored in the machine and patterns sold separately are intended for private use only. Any public or commercial use of copyrighted patterns is an infringement of copyright law and is strictly prohibited.

## ■ About Embroidery Patterns

There are many character and decorative embroidery patterns stored in the machine's memory. You can also use patterns sold separately.

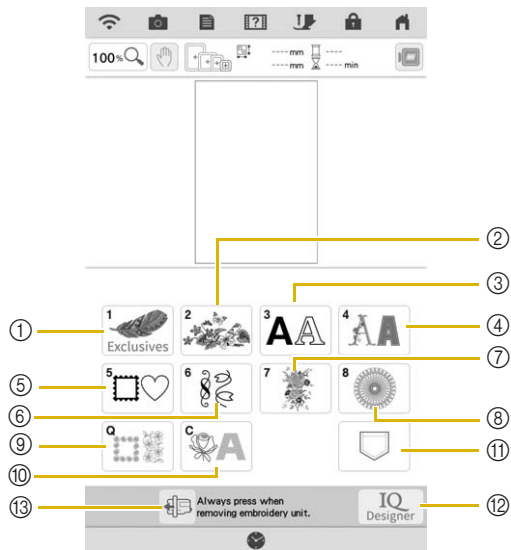

- ① Baby Lock “Exclusives”
- ② Embroidery patterns
- ③ Character patterns (page 70)
- ④ Decorative alphabet patterns
- ⑤ Frame patterns
- ⑥ Utility embroidery patterns
- ⑦ Split embroidery patterns (page 135)
- ⑧ Long-Stitch embroidery patterns  
Before embroidering, refer to the “Embroidery Design Guide”, which includes precautions for obtaining best results.
- ⑨ Quilt sashes and edge-to-edge quilt patterns (page 117, page 123, page 126, page 131)
- ⑩ Couching patterns (page 113)
- ⑪ Patterns saved in the machine's memory, USB media, etc. (page 102)
- ⑫ IQ Designer (page 150)
- ⑬ Touch this key to position the embroidery unit for storage (page 14)

## ■ Pattern Selection Screens

Refer to the “Embroidery Design Guide” for more information on each category’s embroidery pattern.



### Baby Lock “Exclusives”

- Animals
- Celebrate
- Coastal
- Delicate
- Floral
- Heirloom
- Heritage
- Holidays
- Home Accents
- Kids Corner
- Monograms
- Novelty
- Ocean Life
- Quilting
- Sewlebrities
- Vintage



### Embroidery Patterns



### Alphabet Characters

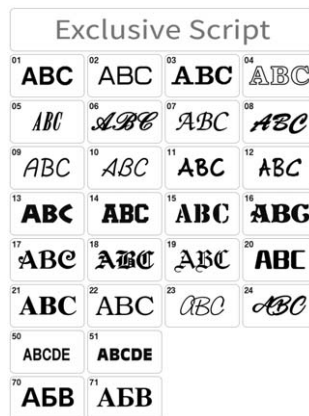

### Decorative Alphabet Patterns



### Frame Patterns

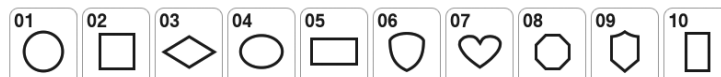

### Utility Embroidery Patterns



### Quilting Border Patterns



### Couching Patterns





# KEY FUNCTIONS

## Editing Patterns







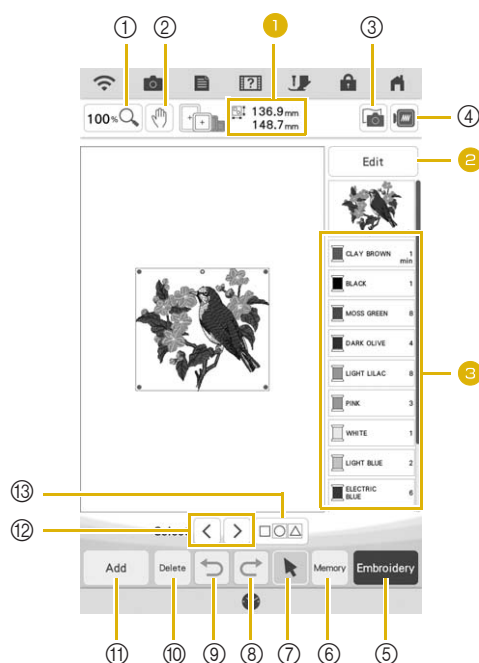





Using these keys, you can edit the pattern as you like.

### Memo

- If a key display is grayed out, you cannot use that function with the selected pattern.











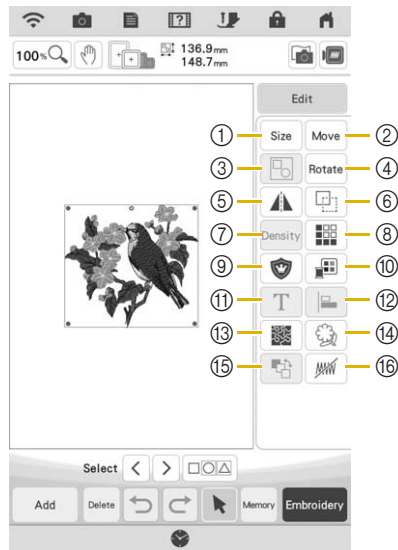







- 1 Shows the size of the entire combined pattern.
- 2 Refer to “Editing Window” on page 36.
- 3 Shows the color sequence and stitching times of each step of the pattern currently selected.

No.	Display	Key Name	Explanation	Page
①		Magnify key	Touch this key to select the magnification ratio.	68
②		Hand key	Touch this key to move the canvas when it is magnified.	68
③		Fabric scan key	Touch this key to scan the fabric to align the embroidery position.	86
④		Image key	Touch this key for a preview of the embroidered image.	58
⑤		Embroidery key	Touch this key to call up the embroidery screen.	—
⑥		Memory key	Touch this key to save a pattern in the machine’s memory, USB media or an SD card. The pattern can also be transferred to a computer via a wireless network connection.	101
⑦		Pattern select key	When a combined pattern is selected, use this key to select a part of the pattern to edit. Touch this key to display the select keys and multiple selection key.	—
⑧		Redo key	Touch this key to redo the last operation that was undone.	—
⑨		Undo key	Touch this key to undo the last operation.	—
⑩		Delete key	Touch this key to delete the selected pattern (the pattern outlined by the red box).	68
⑪		Add key	Touch this key to add another pattern to the editing pattern.	80
⑫		Select key	Touch this key to change a selected pattern when multiple patterns are in the screen.	82
⑬		Multiple selection key	Touch this key to make multiple patterns on the screen to be selected at the same time.	83, 84

## ■ Editing Window

Touch  to display the editing window.



No.	Display	Key Name	Explanation	Page
①		Size key	Touch this key to change the size of the pattern. Patterns can be enlarged or reduced.	60
②		Move key	Touch this key to display the pattern moving window.	59
③		Group key	Touch this key to group the selected multiple patterns.	84
④		Rotate key	Touch this key to rotate the pattern.	59
⑤		Horizontal mirror image key	Touch this key to make a horizontal mirror image of the selected pattern.	62
⑥		Duplicate key	Touch this key to duplicate a pattern.	67
⑦		Density key	Touch this key to change the density of frame patterns or character patterns.	61
⑧		Border function key	Touch this key to create and edit repeated patterns.	62
⑨		Appliqué piece key	Touch this key to create an appliqué piece by embroidering an outline around the selected pattern.	104
⑩		Thread palette key	Touch this key to change the colors of the displayed pattern.	76
⑪		Letter edit key	Touch this key to edit character patterns.	37
⑫		Alignment key	Touch this key to align the selected multiple patterns.	84
⑬		Stippling key	Touch this key to create stippling, echo quilting, or decorative fill around a pattern.	116
⑭		Outline key	Touch this key to extract the outline of a pattern. The extracted pattern can be used with IQ Designer.	185
⑮		Embroidering order key	Touch this key to change the embroidering order of combined patterns.	91
⑯		Deselect region setting (no sew setting) key	Touch this key to specify not to embroider the selected thread color.	68

## Editing Letters

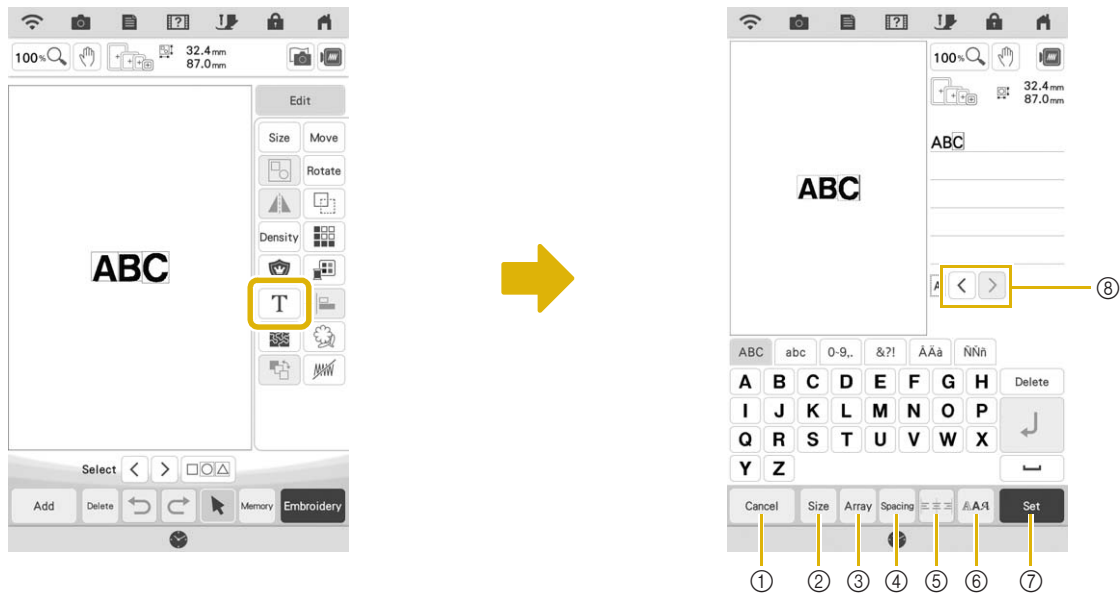

No.	Display	Key Name	Explanation	Page
①		Cancel key	Touch this key to exit the editing character pattern screen.	—
②		Size key	Touch this key to change the size of the character pattern.	72
③		Array key	Touch this key to change the configuration of a character pattern.	73
④		Character spacing key	Touch this key to change the spacing of character patterns.	74
⑤		Alignment key	Touch this key to align the characters at the right, left or center.	71
⑥		Font type key	Touch this key to change the font type.	71
⑦		Set key	Touch this key to apply the text editing.	—
⑧		Character selection keys	Touch these keys to move the cursor and select a character.	—

## Embroidery Screen

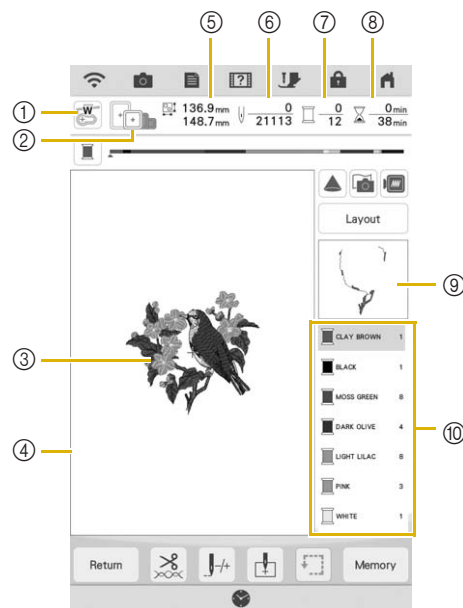

- ① Shows the embroidery foot code.  
Touch to check the needle drop point with the projector. (page 43)
  - ② Shows the embroidery frames that can be used for the selected pattern. Be sure to use the proper frame. (page 27)
  - ③ Shows a preview of the selected pattern.
  - ④ Shows the boundary for embroidering with the selected frame in the settings screen. (page 97)
  - ⑤ Shows the size of the selected pattern.
  - ⑥ Shows how many stitches are in the selected pattern and how many stitches have been embroidered so far.
  - ⑦ Shows the number of colors in the selected pattern and the number of the color currently being embroidered.
  - ⑧ Shows the time necessary to embroider the pattern and the time already spent embroidering the pattern (not including time for changing thread colors and automatically trimming the thread).
  - ⑨ Shows the part of the embroidery that will be embroidered with the first thread color.
  - ⑩ Shows the order for thread color changes and the embroidering time for each thread color.
- \* The displayed time is the approximate time that will be required. The actual embroidering time may be longer than the displayed time, depending on the embroidery frame that is used. In addition, the amount of time required to change thread colors is not included.



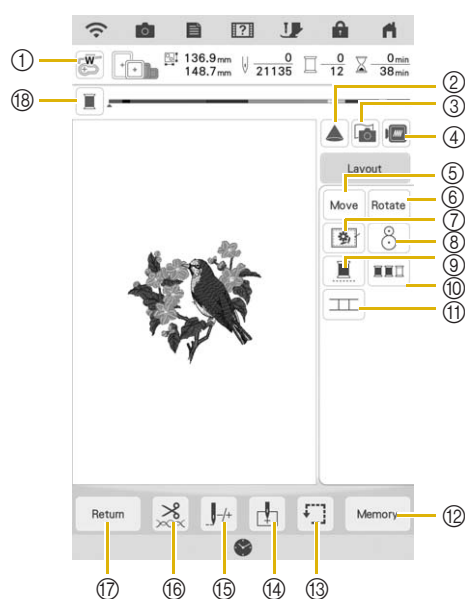











Using these keys, you can move or rotate pattern, etc. Touch Layout to display the editing window.



### Memo

- Some operations or functions are not available for certain patterns. If the key appears in light gray, you cannot use that function or operation with the selected pattern.

1

No.	Display	Key Name	Explanation	Page
①		Needle point check key	Touch this key to check the needle drop point with the projector.	43
②		Projector key	Touch this key to use the projector to project the pattern.	42
③		Fabric scan key	Touch this key to scan the fabric to align the embroidery position.	86
④		Image key	Touch this key for a preview of the embroidered image.	58
⑤	<span style="border: 1px solid gray; padding: 2px;">Move</span>	Move key	Touch this key to display the pattern moving window.	59
⑥	<span style="border: 1px solid gray; padding: 2px;">Rotate</span>	Rotate key	Touch this key to rotate the pattern. You can rotate a pattern 0.1 degree, 1 degree, 10 degrees or 90 degrees at a time.	59
⑦		Basting key	Touch this key to add the basting stitch to the pattern. You can set the desired basting distance.	90
⑧		Embroidery positioning key	Touch this key to align the embroidering position using the built-in camera and embroidery positioning sticker.	45
⑨		Uninterrupted embroidery key	Touch this key to embroider the selected pattern with a single color (monochrome).	86
⑩		Color sorting key	Touch this key to reduce the number of thread color changes by rearranging the embroidering order for the selected pattern to combine parts of the same thread color.	79
⑪		Pattern connect key	Touch this key to start pattern connecting embroidering. You can connect the patterns accurately using the built-in camera.	140
⑫	<span style="border: 1px solid gray; padding: 2px;">Memory</span>	Memory key	Touch this key to save a pattern in the machine's memory, USB media or an SD card. The pattern can also be transferred to a computer via a wireless network connection.	101
⑬		Trial key	Touch this key to check the position of the pattern. The carriage moves to the desired position so you can check that there is enough space to embroider the pattern.	47
⑭		Starting point key	Touch this key to move the needle start position to align the needle with the pattern position.	98, 99
⑮		Forward/Back key	Touch this key to move the needle forward or back in the pattern; useful if the thread breaks while embroidering or if you want to start again from the beginning.	53, 54
⑯		Cut/Tension key	Touch this key to specify automatic thread cutting, thread trimming or the thread tension.	92 - 93, 95, 96
⑰	<span style="border: 1px solid gray; padding: 2px;">Return</span>	Return key	Touch this key to return to the previous screen.	—
⑱		Progress bar switching key	Touch this key to switch the progress bar (which shows the embroidering progress) between showing only one color or all colors.	—

# SELECTING PATTERNS

## Selecting Embroidery Patterns/ Decorative Alphabet Patterns/ Utility Embroidery Patterns

**1** Touch the category tab you want to embroider.

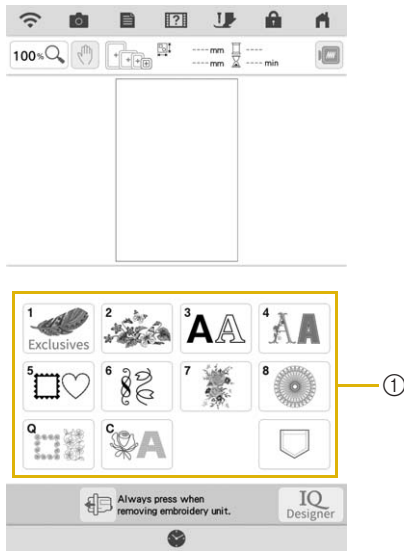

① Pattern category tabs

**2** Select the sub-category, and then select the pattern that you want to embroider.

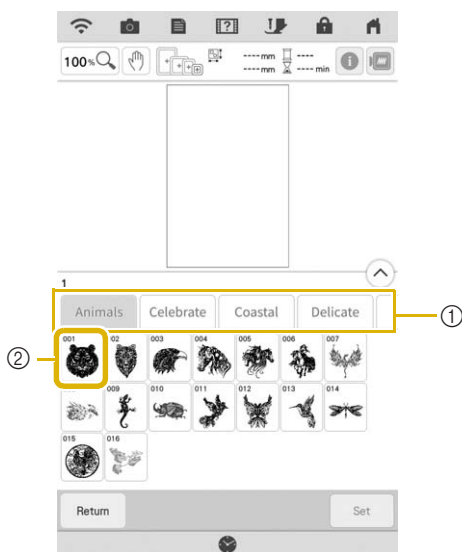

① Sub-category  
② Embroidery pattern

**3** Touch **Set**.



### Memo

- If you touch **i** before touching **Set**, you can see detailed information about the pattern.

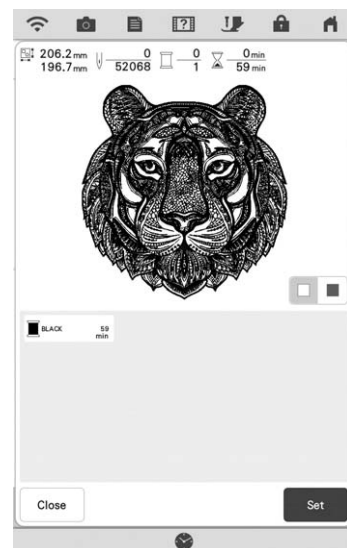

**4** Touch **Edit** to edit the selected pattern.

\* Refer to “Editing Patterns” on page 35 about the “Edit” display.



**5** Touch **Embroidery**.

→ The embroidery screen is displayed.

**6** To reposition the pattern in the embroidery screen before embroidering, touch **Layout**.

\* Refer to “Embroidery Screen” on page 38.  
 \* To return to the previous screen to select another pattern, touch **Return**.

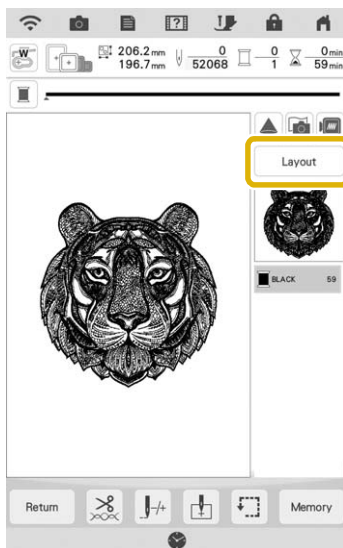

**7** Press the “Start/Stop” button to begin embroidering.

\* Refer to “Embroidering Patterns” on page 50.

## Selecting Frame Patterns

**1** Touch .

**2** Touch the key of the frame shape you want to embroider in the top part of the screen.

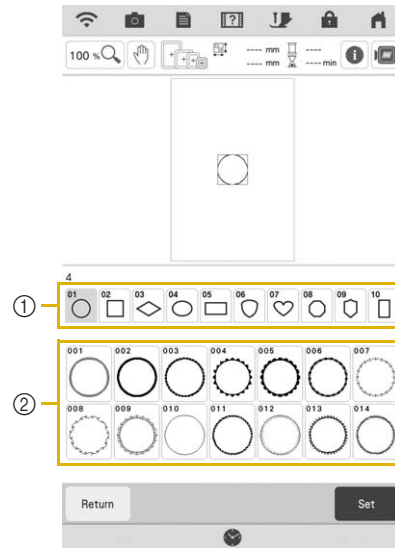

① Frame shapes  
 ② Frame patterns  
 → Various frame patterns are displayed at the bottom part of the screen.

**3** Touch the key of the frame pattern you want to embroider.

\* If you make a mistake selecting the pattern, touch the key of the pattern you want to embroider.  
 → The selected pattern is displayed on the screen.

**4** Follow the steps from **3** to **7** of “Selecting Embroidery Patterns/Decorative Alphabet Patterns/Utility Embroidery Patterns” on page 40.



# CONFIRMING THE PATTERN POSITION

The pattern is normally positioned in the center of the embroidery frame. Check the layout before starting embroidery. You can reposition the pattern for better placement on the garment.

## Checking the Embroidery Pattern with the Projector

Using the projector, the selected embroidery pattern can be projected onto the fabric.

**1** Touch  in the embroidery screen.

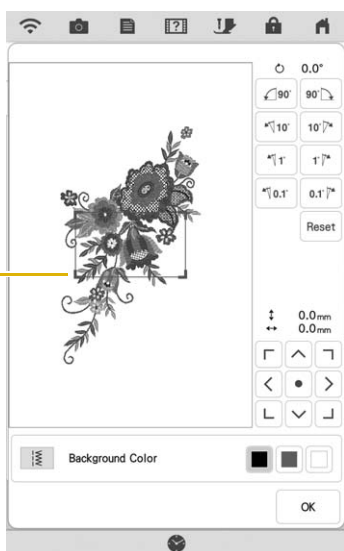
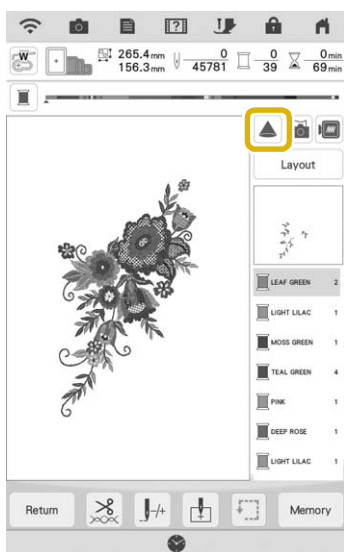

- ① Display area
- The part of the pattern within the display area will be projected onto the fabric.

**2** Check the embroidery pattern projected onto the fabric.

You can move the pattern while checking the pattern within the display area. When the color of the pattern and the background is the same, change the background color.

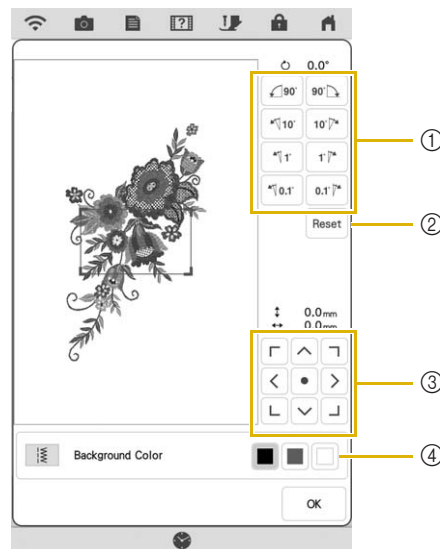

- ① Touch to change the angle.
- ② Touch to return the pattern to its original angle.
- ③ Touch to move the pattern.
- ④ Touch to select which background color will display when using projector function.

### Memo

- To change the position of the display area, drag the display area with your finger. At the same time, the embroidery frame may be moved.

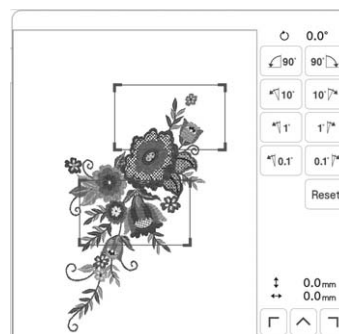



## Checking the Needle Drop Point With the Projector

With the projector pointer, you can check the needle drop point before embroidering.

### 1 Touch in the embroidery screen.

→ The pointer of the projector indicates the needle drop point onto the fabric.

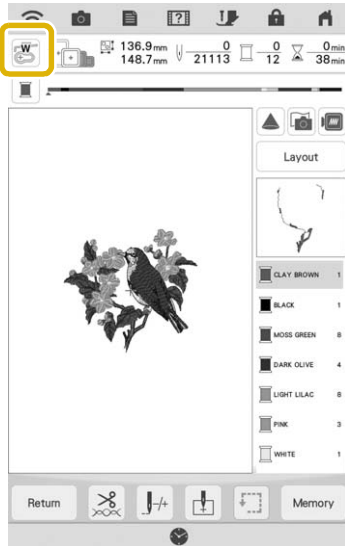

### Memo

- The color and shape of the pointer can be changed in the settings screen.



- When the pointer of the projector is turned on, the embroidery foot height is automatically adjusted according to the fabric thickness.
- If embroidery foot "W+" with LED pointer (sold separately) is installed, the LED pointer is turned on.
- The pointer of the projector turns off automatically by lowering the embroidery foot or returning to the previous page.

### Note

- With fabric that has a very uneven surface such as thick fabric or quilting, the fabric thickness may not be correctly measured. In this case, the pointer indication should be used only as a reference.

## Aligning the Embroidering Position Using the Built-In Camera

The camera built into this machine can be used to easily align the embroidering position. This is useful for patterns which need to be embroidered in a particular position as shown below.



### 1 Use a chalk pencil to draw a cross at the desired embroidering location.



① Chalk pencil mark

### 2 Hoop the fabric.

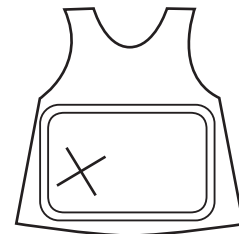

### 3 Select the pattern on your machine and touch .

4 Touch  in the embroidery screen.

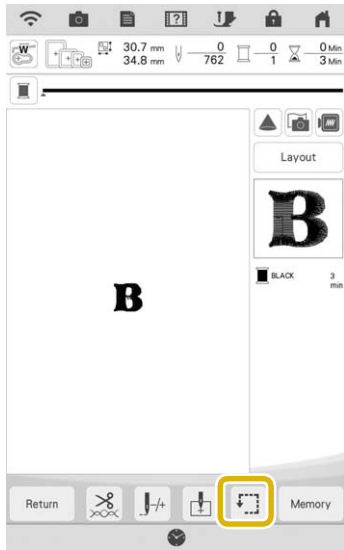

5 Touch  to set the starting point to the center of the pattern.

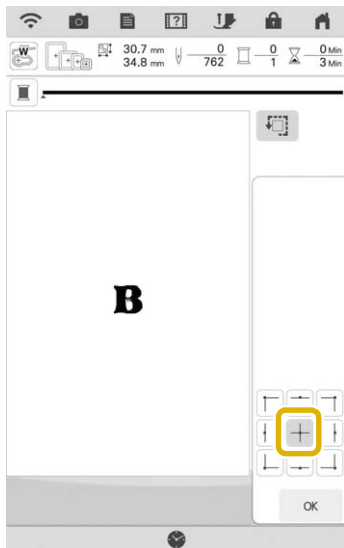

6 Touch  .

7 Press the “Presser Foot Lifter” button to lower the embroidery foot.

8 Touch  .



9 Touch the positioning keys to move the embroidery frame until the cross-shaped chalk mark drawn on the fabric is displayed in the camera view window.

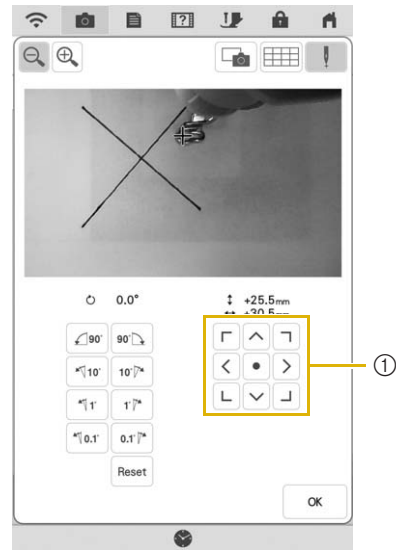

① Positioning keys

10 Touch  to display the grid lines.

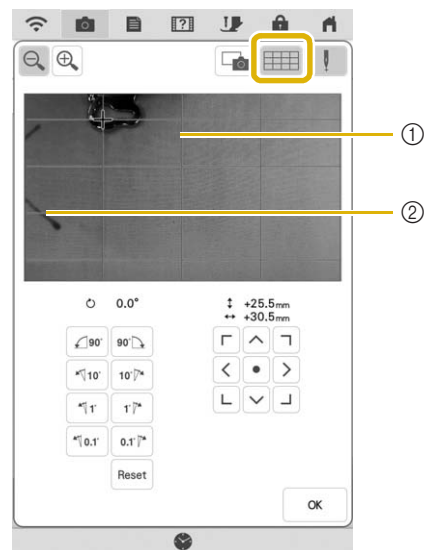

① Grid lines

② Chalk mark on the fabric

 **Memo**

- Touch  to enlarge the camera view. By enlarging the camera view, you can make a close adjustment for the center point of the pattern moving the embroidery frame little by little.

- 11 Touch the orientation of the pattern by touching the orientation keys until the grid lines are parallel with the chalk mark drawn on the fabric. (Refer to “Rotating the Pattern” on page 59.)

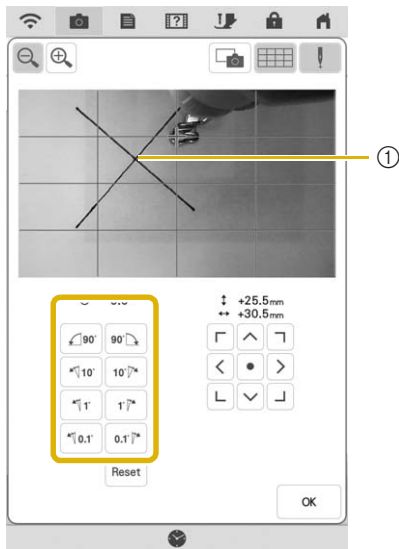

① Center point of the pattern

- 12 Touch the positioning keys to move the embroidery frame until the center point of the pattern in the camera view window is aligned with the chalk mark drawn on the fabric.

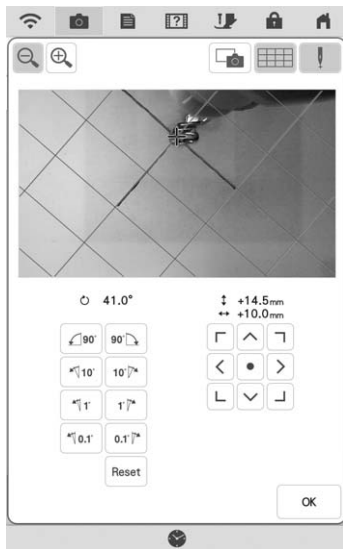

- 13 Touch  to return to the previous screen.

- 14 Press the “Start/Stop” button to begin embroidering.

\* Refer to “Embroidering Patterns” on page 50.

## Using the Embroidery Position Sticker to Align the Embroidering Position

The embroidering position can easily be aligned using the machine’s built-in camera and the included embroidery positioning sticker.

### Note

- Depending on the type of fabric that is used, a part of the embroidery positioning sticker may remain attached when it is peeled off. Before using the embroidery positioning sticker, check that it can be cleanly removed from a scrap piece of the fabric to be used.

- 1 Touch  to display the editing window, and then touch .

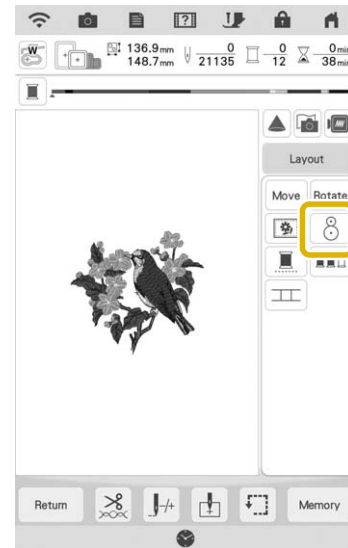

- 2 Following message appears. Touch .

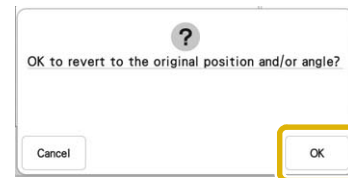

→ The embroidering position will return to the original position, even if you changed before.

**3** Select the position you want to set as the reference point.



\* Select  if you want to embroider referring the embroidery positioning sticker as the center of the pattern.

**4** Affix the embroidery positioning sticker to the location in the fabric to be embroidered. Place the embroidery positioning sticker so that the center of the larger circle is at the center or edge of the embroidery pattern.

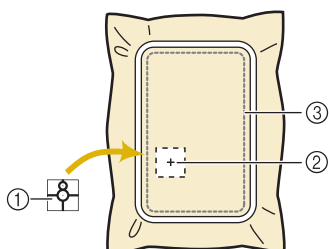

- ① Embroidery positioning sticker
- ② Center or edge of the embroidery pattern
- ③ Embroidery field

 **Memo**

- Affix the embroidery positioning sticker so that the smaller circle is on top. The angle of the pattern depends on the angle at which the embroidery positioning sticker is affixed. In order to change the angle at which the pattern will be embroidered, affix the embroidery positioning sticker at the desired angle.

**5** Touch .

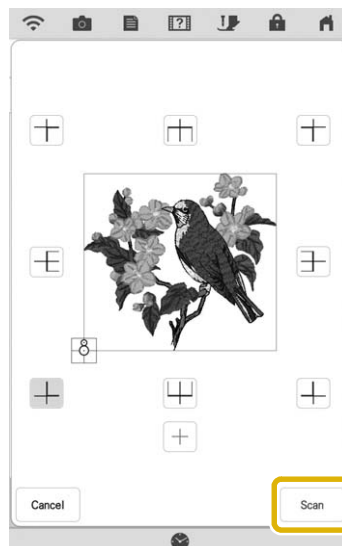

 **Note**

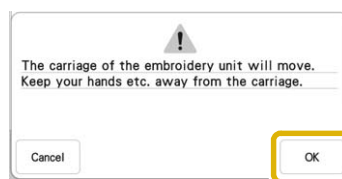

- Attach embroidery foot “W” before touching . The embroidery foot “W” lowers and check the fabric thickness, to help the built-in camera recognize the embroidery positioning sticker.

**6** Following message appears. Touch .





→ The built-in camera automatically searches for the embroidery positioning sticker, and then the carriage is moved so that the selected reference point of the embroidery pattern is aligned with the embroidery positioning sticker.

 **Note**

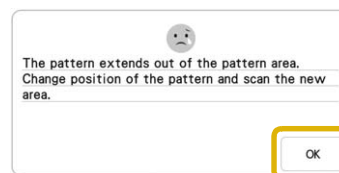
- If the following error message appears, touch , rehoop the fabric so that the pattern is within the embroidery field, and then touch  again.



**7** A reminder message appears. Remove the embroidery positioning sticker from the fabric, and touch .

- \* To remove the embroidery positioning sticker more easily, touch  so that the carriage moves slightly forward and away from under the needle. After the embroidery positioning sticker is removed, touch .

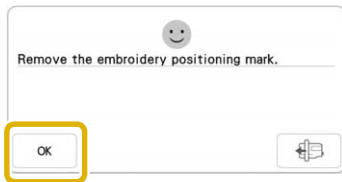
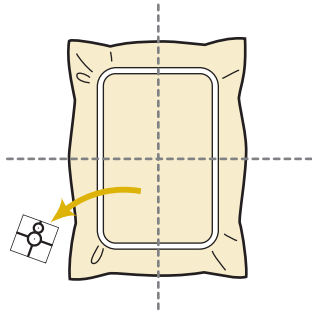

**8** Press the “Start/Stop” button to begin embroidering.

- \* Refer to “Embroidering Patterns” on page 50.

## Checking the Pattern Position

The carriage moves and shows the pattern position. Watch the embroidery frame closely to make sure the pattern will be embroidered in the right place.

**1** Touch .

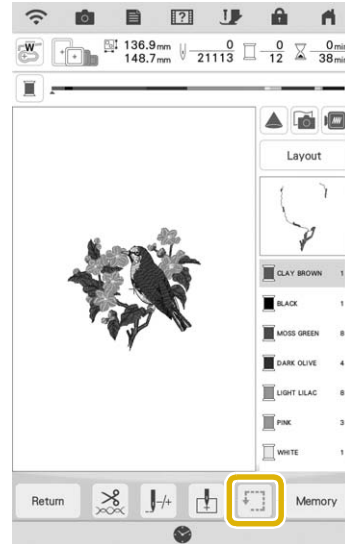

→ The following screen is displayed.

**2** From , touch the key for the position that you want to check.

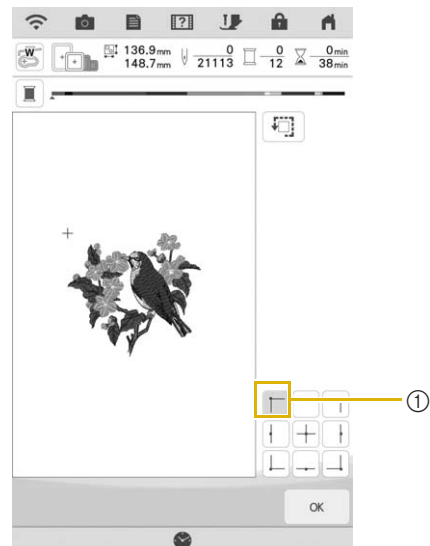

① Selected position

→ The carriage will move to the selected position on the pattern.

 **Memo**

- To see the entire embroidering area, touch . The carriage moves and shows the embroidery area.

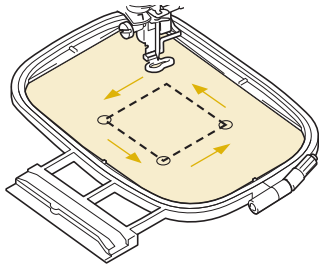

 **CAUTION**

- Do not lower the needle when the embroidery frame is moving. If the needle is down, it could break and result in injury.

**3** Touch .

# EMBROIDERING A PATTERN

## Embroidering Attractive Finishes

Many factors are involved in achieving a beautiful embroidery result. Using the appropriate stabilizer (page 26) and hooping the fabric in the frame (page 27) are two important factors mentioned earlier. Another important point is the appropriateness of the needle and thread being used. See the explanation of threads below. Included with this machine are two bobbin cases. Follow the explanation below.

Thread	Upper thread	Use embroidery thread intended for use with this machine.
	Bobbin thread	Use embroidery bobbin thread intended for use with this machine.

### Memo

- If you use threads other than those listed above, the embroidery pattern may not embroider out correctly.

**Bobbin case (recommended for sewing and for embroidering with included 60 weight bobbin thread)**

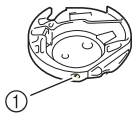

- ① Standard bobbin case (green marking on the screw)

Standard bobbin case originally installed in the machine has a green marking on the screw. We recommend using the included embroidery bobbin thread with this bobbin case. Do not adjust the tension screw on this bobbin case with the green marked screw.

**Bobbin case (for prewound or other embroidery bobbin threads)**

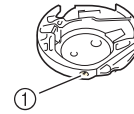

- ① Alternate bobbin case (no color on the screw)

The bobbin case with no color on the screw is set with tighter tension for embroidery with different weights of bobbin threads and a variety of embroidery techniques. This bobbin case is identified with a dark colored mark on the inside of the bobbin cavity. The tension screw on this case can be adjusted if necessary. (page 94)

## CAUTION

- When embroidering large items (especially jackets or quilts), do not let the fabric hang off of the table. Otherwise, the embroidery unit cannot move freely and the embroidery frame may strike the needle, causing the needle to break and possibly causing injury.

### Note

- Be sure to do trial embroidery using same fabric and threads as project in order to check the embroidering results.

## Embroidering Patterns

Example:

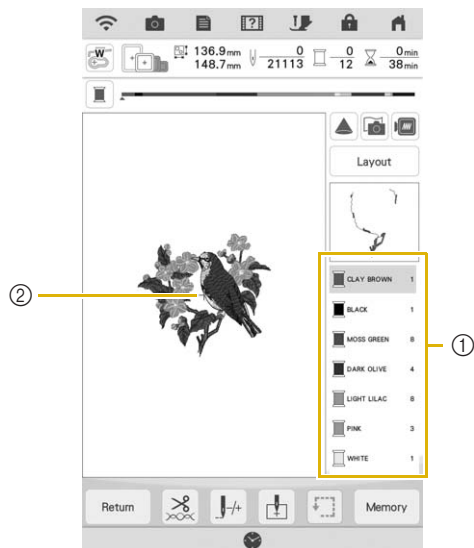

- ① Embroidery color order
- ② Cursor

### Memo

- The [+/-] cursor moves over the pattern, showing which part of the pattern is being embroidered.

## 1 Using the automatic needle threader, thread the machine for the first color.

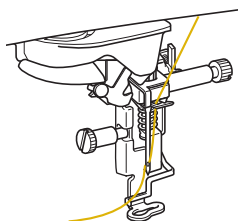

## 2 Lower the embroidery foot, then press the "Start/Stop" button to start embroidering.

→ When the first color is completely embroidered, the machine will automatically trim the threads and stop. The embroidery foot will then automatically be raised.

On the embroidery color order display, the next color will move to the top.

### Memo

- A setting in the settings screen can be specified so that pressing the "Start/Stop" button before starting embroidering automatically lowers the embroidery foot. (page 7)



- If you want to get more attractive finishes, try the procedures below;
  - After 5-6 stitches, press the "Start/Stop" button again to stop the machine.
  - Trim the excess thread at the beginning of embroidering. If the thread at the beginning of embroidering is under the embroidery foot, raise the embroidery foot, then trim the excess thread.

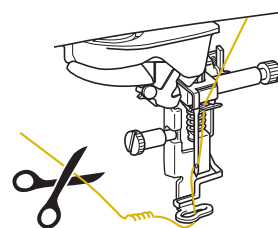

- If there is thread left over from the beginning of embroidering, it may be embroidered over as you continue embroidering the pattern, making it very difficult to deal with the thread after the pattern is finished. Trim the threads at the beginning of each thread change.

## 3 Remove the thread for the first color from the machine. Thread the machine with the next color.



## 4 Repeat the same steps for embroidering the remaining colors.

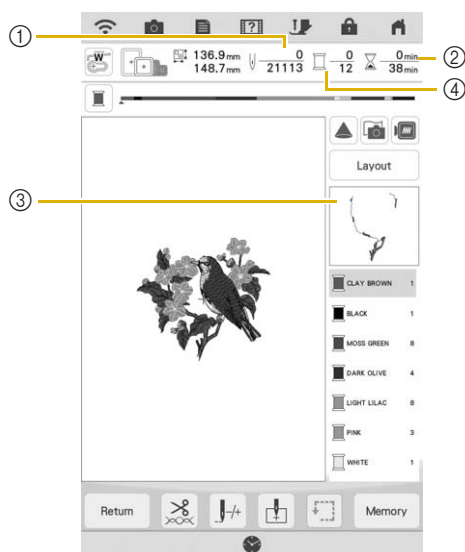

- ① Current stitch numbers/Total stitch numbers
  - ② Current time/Total time
  - ③ The part of pattern to be embroidered next
  - ④ Embroidered colors/Total colors
- When the last color is embroidered, [Finished embroidering] will appear on the display. Touch , and the display will return to the original screen.

### Memo

- The Thread Trimming Function is originally set to trim excess thread jumps (threads linking parts of the pattern, etc.). Depending on the type of thread and fabric that are used, an end of upper thread may remain on the surface of the fabric at the beginning of the stitching. After embroidering is finished, cut off this excess thread. If the setting has been turned off, trim the excess thread jumps using scissors after the pattern is finished. Refer to page 96 for information on the thread trimming function.

# ADJUSTMENTS DURING THE EMBROIDERY PROCESS

## Note

- Be careful not to bump the embroidery unit carriage or the embroidery foot when removing or attaching the embroidery frame. Otherwise, the pattern will not embroider correctly.

## If the Bobbin Runs out of Thread

When the bobbin begins to run out of thread during embroidering, the machine will stop and the message below will appear.

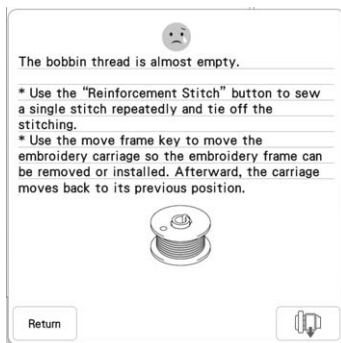

- 1 Leave the message displayed and then press the “Reinforcement Stitch” button  to sew reinforcement stitches to prevent stitches from unraveling.

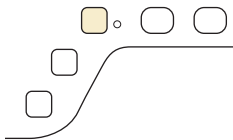

- 2 Touch .

## Memo

- If the message appears when only a few more stitches are necessary to complete embroidering, simply press the “Start/Stop” button, allowing about 10 more stitches to be embroidered.
- If [Upper and Bobbin Thread Sensor] in the General settings screen is set to [OFF], the message shown above does not appear.
- Touch  to close the message.

- 3 Touch .

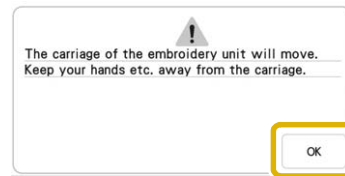

→ After the thread is automatically cut, the carriage will move.

- 4 Leave the message displayed and then continue with the next step.

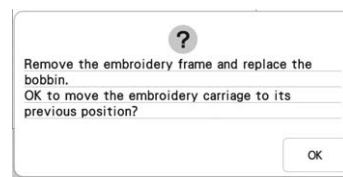

- 5 Unlock the frame-securing lever and remove the embroidery frame.

\* Be careful not to apply strong force to the fabric at this time. Otherwise, the fabric may loosen in the frame.

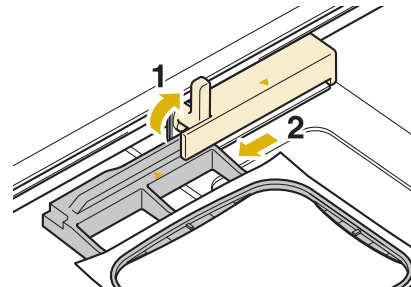

- 6 Insert a wound bobbin into the machine. (Refer to “Setting the Bobbin” on page 19.)

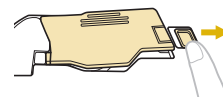

- 7 Attach the embroidery frame.

- 8 Touch .

→ The carriage will move to its previous position.

- 9 Press the “Reinforcement Stitch” button to sew reinforcement stitches at the beginning of sewing, and then press the “Start/Stop” button to continue embroidering.

## If the Thread Breaks during Embroidering

- 1 If the upper thread is broken or runs out, redo the upper threading.

### Memo

- If the bobbin thread is broken, follow the directions in “If the Bobbin Runs out of Thread” on page 52.

- 2 Touch .

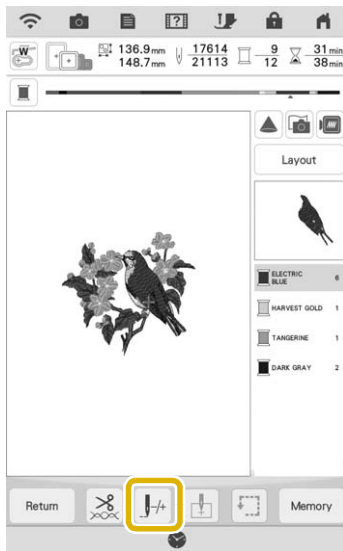



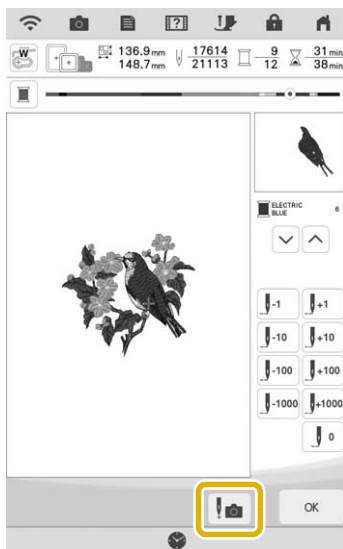

- 3 Press the “Presser Foot Lifter” button to lower the embroidery foot.

- 4 Touch .





→ The camera view window appears.

- 5 Touch  or  to move the needle back the correct number of stitches before the spot where the thread broke.

- \* If you cannot move back to the spot where the thread broke, touch  or  to select the color and move to the beginning position of that color, then use  or  to move ahead to slightly before where the thread broke.



- \* Touch  to enlarge the image in the screen.
- \* Touch  to remove “+” from the screen.

- 6 Touch  to close the camera view window.

- 7 Touch  to return to the original screen.

- 8 Press the “Reinforcement Stitch” button to sew reinforcement stitches at the beginning of sewing, and then press the “Start/Stop” button to continue embroidering.

## Restarting from the Beginning

- 1 Touch .

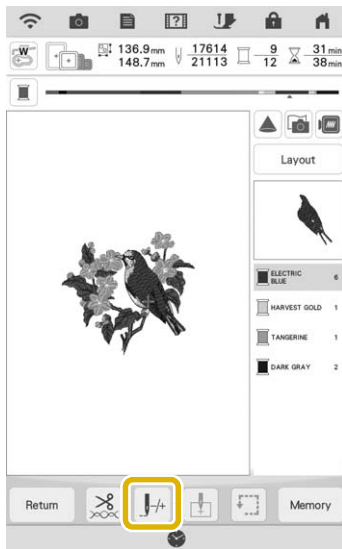

- 2 Touch .

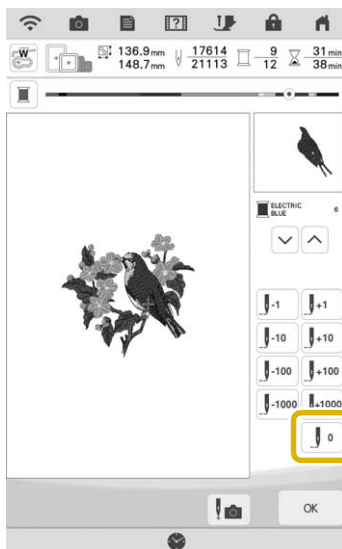

→ The carriage moves, returning the needle to the pattern's beginning position.

- 3 Press the "Presser Foot Lifter" button to lower the embroidery foot and start embroidering.

## Resuming Embroidery after Turning Off the Power

The current position, angle, color and stitch number are saved when embroidery is stopped. The next time the machine is turned on, you have the option to continue or delete the pattern.

### Memo

- Even if the power goes out in the middle of embroidery, the machine returns to the point where embroidery was stopped when the machine is turned on again.

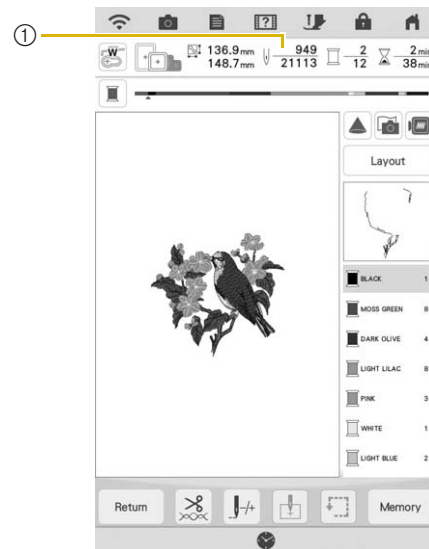

- ① Current stitch number when embroidery was stopped

### Note

- Do not remove the embroidery unit or the memory will no longer remember your design.

- 1 Turn the main power to ON.

- 2 Follow the instructions shown on the screen and remove the embroidery frame.

→ The following message will appear.

### 3 Attach the embroidery frame and touch

OK .

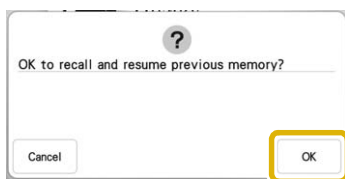

→ The previous embroidery screen displayed before the machine was turned off appears.

#### Memo

- If you want to start a new embroidery pattern, touch .
- If embroidery was interrupted before a color segment was completed, follow the steps on page 53 to move the needle back to overlap the previous stitching by a few stitches to avoid unraveling.

### 4 Continue embroidering.

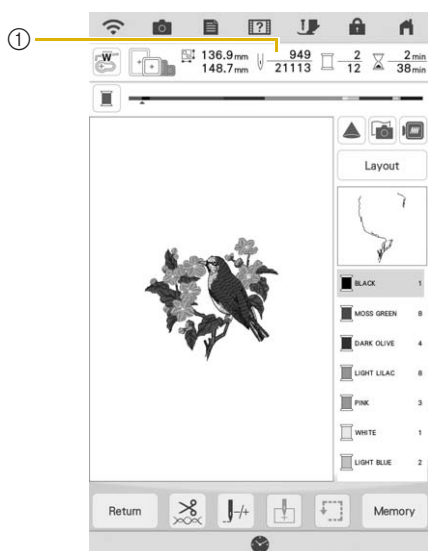

① Stitch number when embroidery is resumed

# IQ INTUITION- MONITORING APP

With the IQ Intuition- Monitoring App installed on your smart device and the machine and smart device connected to the same wireless network, you can check the operating status of the machine. In addition, you can receive notifications when the machine stops.

## ■ Installing the App

- 1 Use your smart device to scan the appropriate QR code below to visit Google Play™ or the App Store.



Android™:

[https://www.babylock.com/IQIntuition\\_MonitoringAndroid](https://www.babylock.com/IQIntuition_MonitoringAndroid)



iOS:

[https://www.babylock.com/IQIntuition\\_MonitoringiOS](https://www.babylock.com/IQIntuition_MonitoringiOS)

- 2 Install [IQ Intuition- Monitoring].



IQ Intuition- Monitoring

### 📖 Memo

- To download and install the app, you can also search for [IQ Intuition- Monitoring] in Google Play or the App Store.
- Visit the following web site for support information on the app.  
<https://www.babylock.com/support>

## ■ Monitoring

### 📖 Memo

- The app will be updated from time to time. The following descriptions may differ from the actual screens and operations.

- 1 Connect the machine to your wireless network.

\* Refer to "WIRELESS NETWORK CONNECTION FUNCTIONS" in the machine's Instruction and Reference Guide (Sewing).

- 2 Confirm that your smart device and your machine are connected to the same network.

- 3 Tap the icon for [IQ Intuition- Monitoring] on the smart device to start the app.

- 4 Follow the instructions that appear in the app to connect the app to your machine.

\* Select the name that appears beside [Machine name] in the settings screen on your machine.

→ The machine can now be monitored.



Chapter **2**

# Basic Editing



# BASIC EDITING

## Previewing the Pattern

1 Touch .



→ An image of the pattern as it will be embroidered appears.

2 Touch  to select the frame used in the preview.

- \* Frames displayed in light gray cannot be selected.
- \* Touch  to enlarge the image of the pattern.
- \* The pattern can be embroidered as it appears in the following display.





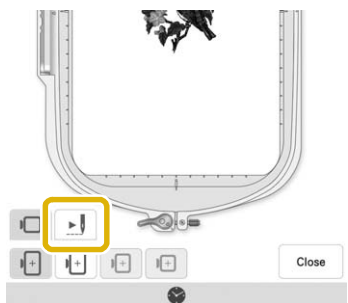

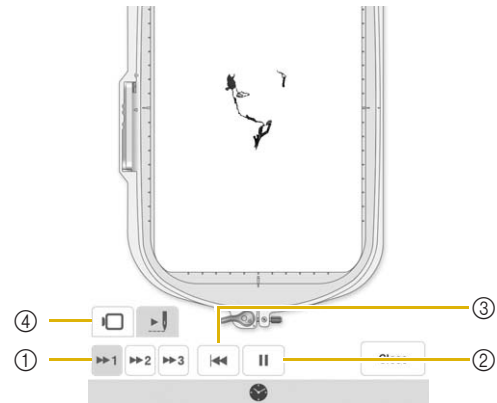

3 Touch  to check the embroidering order.



→ The stitch simulator screen appears.





- ① Select the simulation speed. Touch ,  or  to change the speed. The speed can even be changed while the simulation is running.
- ② Play/Pause  
When touching , icon changes to .
- ③ Return to beginning.
- ④ Touch  to return to the embroidery frame selection screen.

4 Touch .



## Moving the Pattern

- 1 Touch **Edit**, and then touch **Move** to display the pattern move window.
- 2 Select the desired pattern by touching **<** **>** if there are multiple patterns on the screen.
- 3 Use  to move the pattern in the direction shown by the arrow. Touch  to center the pattern.

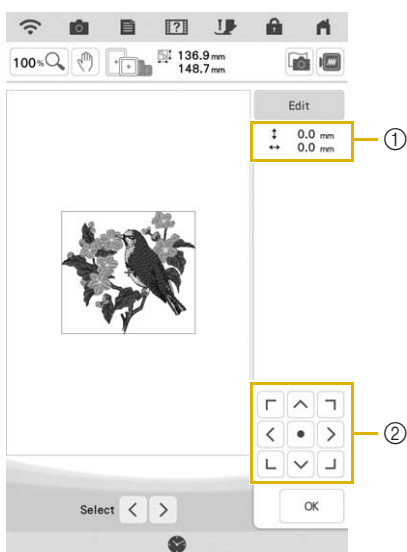

- ① Distance from the center
- ② Pattern movement keys

The pattern can be dragged by selecting it directly in the screen with your finger, the included dual purpose stylus or fine tipped stylus pen.

- 4 Touch **OK**.

## Rotating the Pattern

- 1 Touch **Edit**, and then touch **Rotate**.
  - \* Select the desired pattern by touching **<** **>**, if there are multiple patterns on the screen.



- 2 Select the key indicating the desired direction and angle for rotating the pattern.

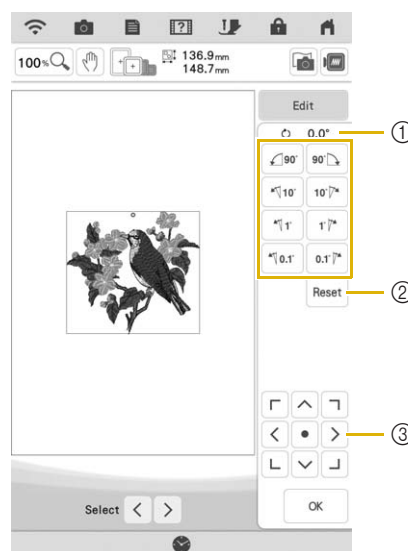

- ① Degree of rotation
- ② Touch to return the pattern to its original position.
- ③ Touch to move patterns.

**Example:**  rotates 90 degrees clockwise.

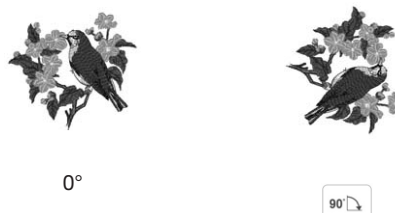

### Memo

- You can also rotate patterns by dragging  at the top of the pattern.

- 3 Touch **OK**.

# Changing the Size of the Pattern

1 Touch **Edit**, and then touch **Size**.

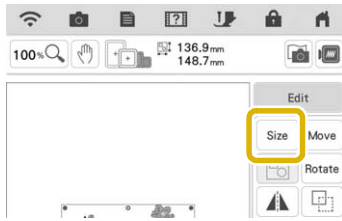

2 Select the size changing method.



\* :

Change the pattern size while maintaining the number of stitches. Enlarged patterns will be less dense, and reduced patterns will be more dense. In order to maintain embroidering quality, there is a limit to how much the embroidery pattern can be enlarged or reduced.

\* :

With this function, the pattern will be enlarged or reduced at a larger ratio than with normal pattern resizing. The size of the pattern can be increased to 200% or reduced to 60% of its original size. Change the pattern size while maintaining the thread density. The number of stitches is recalculated depending on the pattern size. If this key appears in light gray and is not available, this function cannot be used with the selected pattern. When making a border pattern, change the size using this function and then apply the border setting.

### Memo

- After the pattern size is changed using , the thread density can be changed in the embroidery edit screen. For details, refer to “Changing the Density” on page 61.
- If the pattern is enlarged and there is space between stitches, a better effect can be achieved by increasing the thread density.
- If the pattern is reduced and the stitching is too thick, a better effect can be achieved by reducing the thread density.

3 Select the direction in which to change the size.

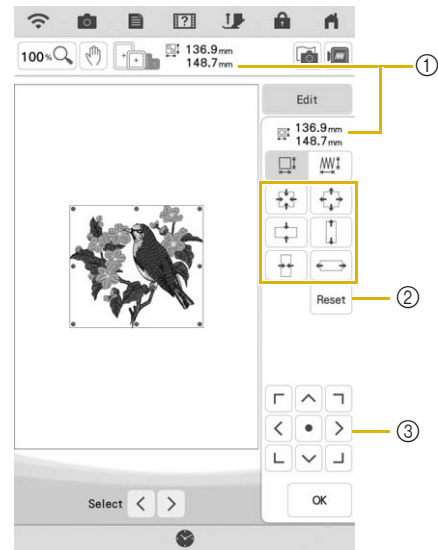

- ① Size of the pattern
- ② Touch to return the pattern to its original size.
- ③ Touch to move patterns.

### Example:

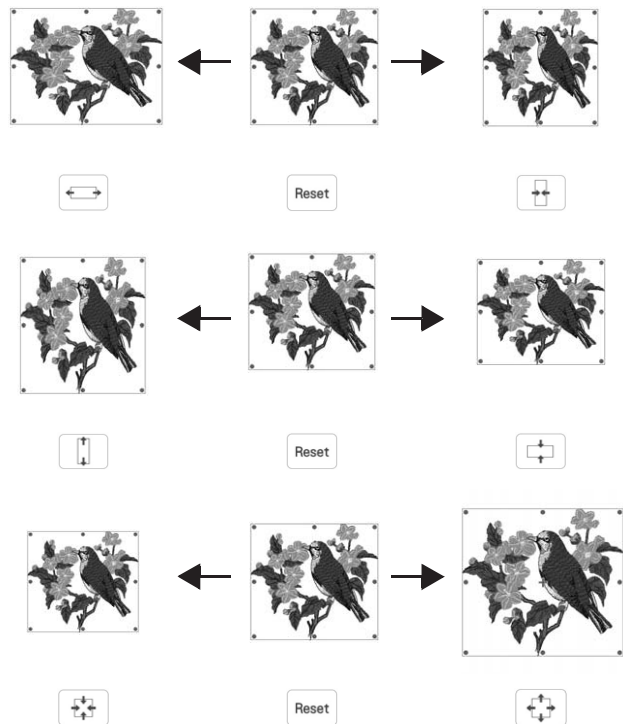

### Memo

- Each pattern’s range of size adjustment depends upon the original size of the design and the maximum embroidery area.
- Some patterns or characters can be enlarged to a greater degree if they are rotated 90 degrees.
- You can also change the pattern size by dragging the red point on the pattern image.

**4** Touch .

**Note**

- Be sure to do trial embroidery using same fabric and threads as project in order to check the embroidering results.

## Changing the Density

The thread density can be changed. This setting is available for some alphabet character patterns, frame patterns and so on. Other patterns are available after enabling patterns to change the density. For details, refer to “Changing the Size of the Pattern” on page 60.

**1** Touch , and then touch .

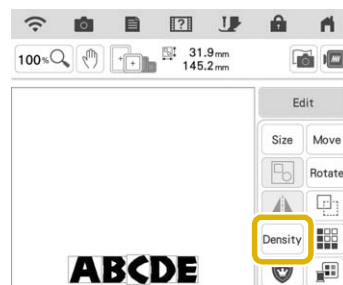

**2** Change the density.

- \* Touch  to make the pattern less dense.
- \* Touch  to make the pattern more dense.

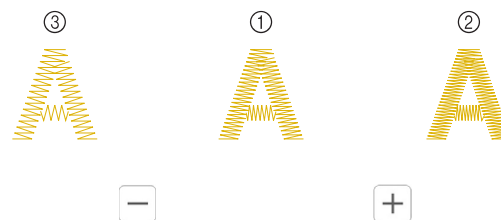
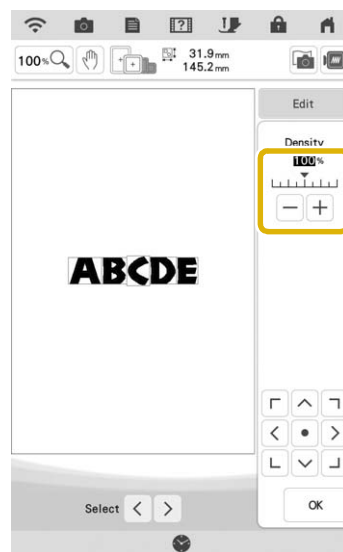

- ① Normal
- ② Fine (stitches closer together)
- ③ Coarse (stitches farther apart)

**3** Touch .

## Creating a Horizontal Mirror Image

Touch **Edit**, and then touch  to create a horizontal mirror image of the selected pattern.

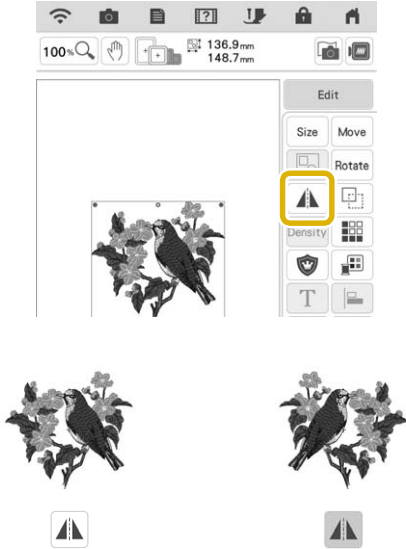

## Designing Repeated Patterns

### ■ Embroidering Repeated Patterns

Using the border function, you can create repeated patterns. You can also adjust the spacing of the patterns.

**1** Touch **Edit**, and then touch .

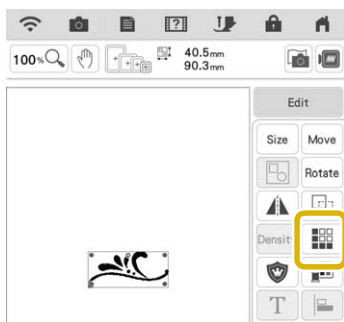

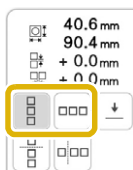

**2** Select the direction in which the pattern will be repeated.





→ The pattern direction indicator will change depending on the direction selected.

**3** Repeat the pattern.

### Vertical direction



Use  to repeat the pattern above and  to repeat the pattern below.

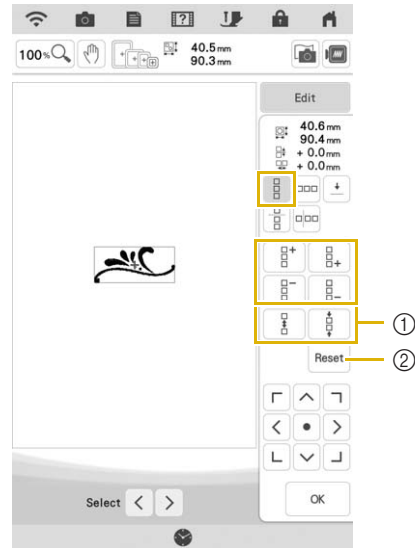

- \* To delete above pattern, touch .
- \* To delete below pattern, touch .



- ① Spacing keys
- ② Key to cancel pattern repeating

### Horizontal direction

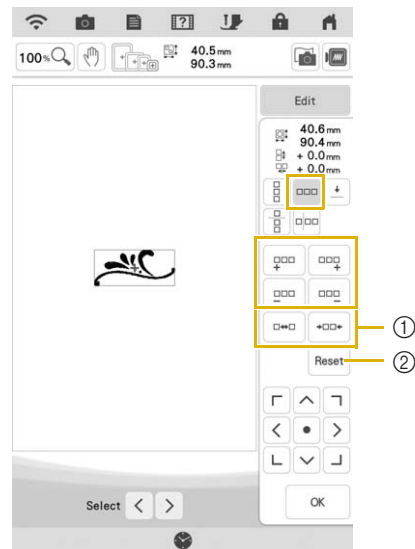

Use  to repeat the pattern to the left and  to repeat the pattern on the right.

- \* To delete patterns from the left, touch .
- \* To delete patterns from the right, touch .



- ① Spacing keys
- ② Key to cancel pattern repeating

#### 4 Adjust the spacing of the repeated pattern.

- \* To widen spacing, touch .
- \* To tighten spacing, touch .

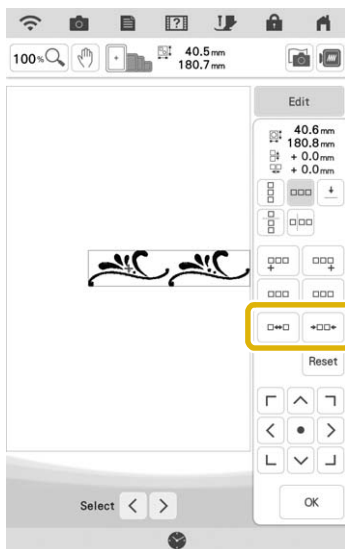

#### 5 Complete repeated patterns by repeating steps 2 through 4.

#### 6 Touch .

#### Memo

- When there are two or more patterns, all patterns will be grouped together as one pattern in the red frame.

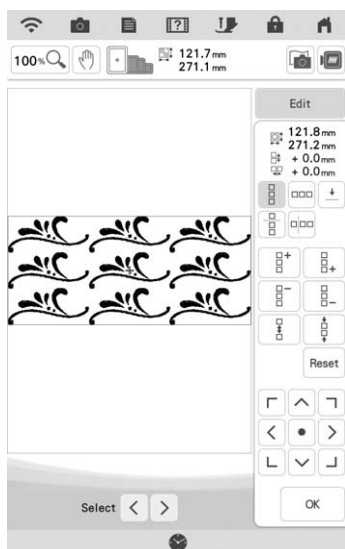



- When changing the direction in which the pattern will be repeated, all of the patterns in the red frame will automatically be grouped as one repeating unit. Refer to the following section on how to repeat one element of a repeated pattern.

### Repeating One Element of a Repeated Pattern

By using the Cut function, you can select one element of a repeated pattern and repeat only that single element. This function allows you to design complex repeated patterns.

#### 1 Touch .

#### 2 Choose the direction in which the repeated pattern will be cut.

- \* Touch  to cut vertically.
- \* Touch  to cut horizontally.

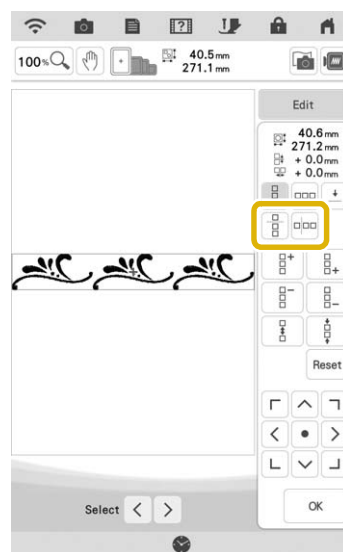

→ The pattern direction indicator will change depending on the direction selected.

#### 3 Use and to select the cut line.

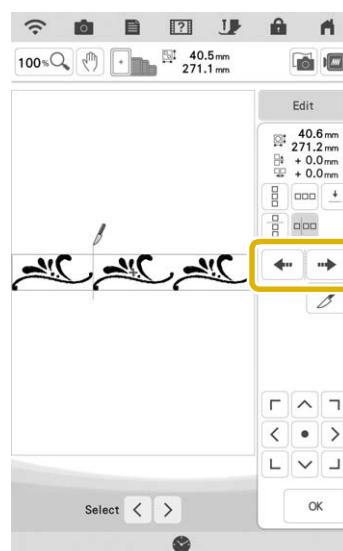

→ The cut line will move.

**4** Touch .

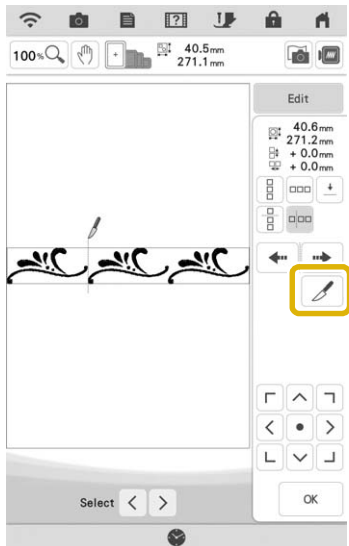

→ The repeated pattern will be divided into separate elements.

**5** Touch .

**6** Use  and  to select the element to repeat.

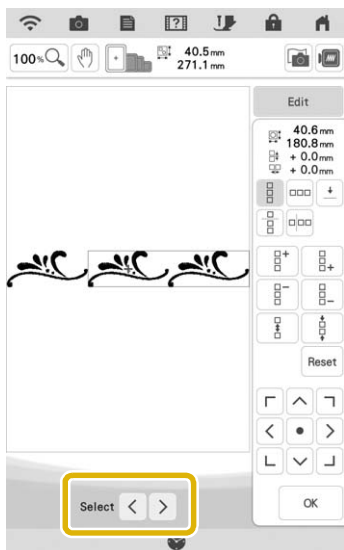

**7** Repeat the selected element.

**8** Touch .

 **Memo**

- Once you have cut a repeated pattern into separate elements, you cannot return to the original repeated pattern.
- Each element can be edited separately in the edit screen. Refer to “Selecting Combined Embroidery Patterns” on page 82.
- Touch  to change the embroidering order in order to minimize the number of the thread color changes.

**■ Assigning Thread Marks**

By embroidering thread marks, you can easily align patterns when rehooping the fabric to embroider a series. When embroidering is finished on a pattern, a thread mark in the shape of an arrow will be sewn using the final thread. When embroidering a series of patterns, use the point of this arrow for positioning the following designs to be embroidered.

**1** Touch , and then touch .



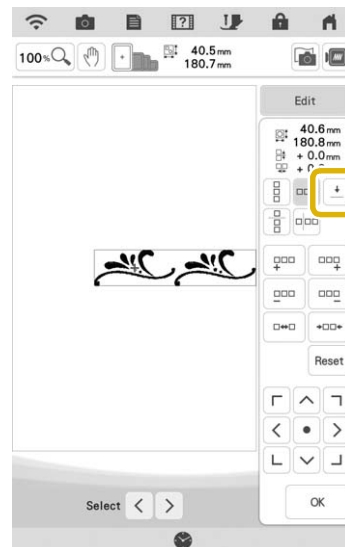

**2** Touch .

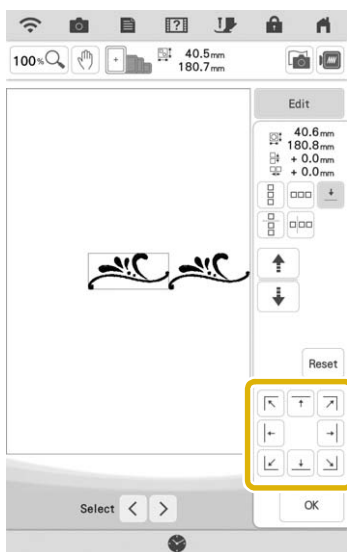

- 3 Touch  to select the thread mark to be sewn.



**Memo**

- When there are two or more elements, use  and  or  and  to select a pattern that you want to assign a thread mark(s) to.

- 4 Touch .

## Embroidering the Pattern Repeatedly

After creating the repeated pattern, rehoop the embroidery frame and keep embroidering for the next pattern.

**Memo**

- Using the optional magnetic frames, the fabric can be easily rehooped. For details, refer to the manual included with magnetic frame.

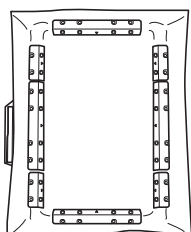

- 1 Select the border pattern with the thread mark at the center of the end of the pattern.

\* Refer to “Assigning Thread Marks” on page 64.

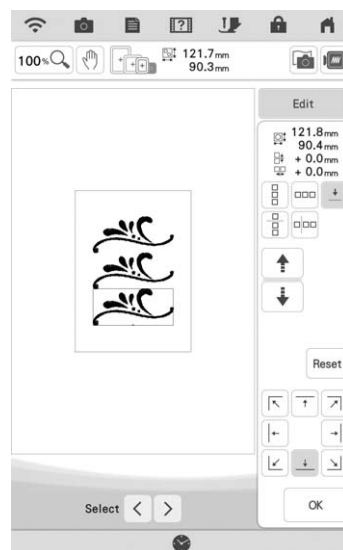

- 2 Touch , then .

- 3 Press the “Start/Stop” button to begin embroidering.

→ When embroidering is finished, the thread mark is embroidered with the last thread color.



- 4 Remove the embroidery frame.

- 5 Rehoop the fabric in the embroidery frame.



**Note**

- Adjust the position of the fabric so that the embroidering area for the next pattern is within the embroidering area.

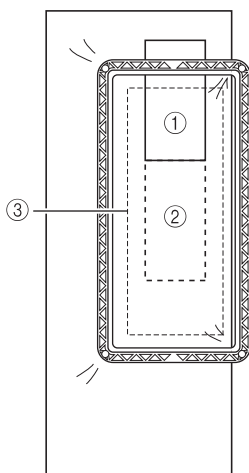

- ① Pattern embroidered first
- ② Position of pattern to be embroidered next
- ③ Embroidering area

**6** Attach the embroidery frame to the machine, and then touch .

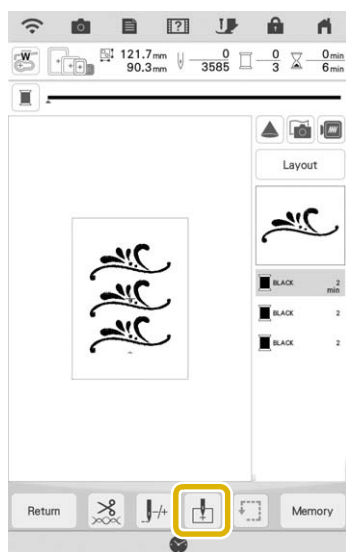

**7** Touch  to set the starting point to the top center of the pattern.



**8** Touch .

**9** Press the "Presser Foot Lifter" button to lower the embroidery foot.

**10** Touch .

**11** Touch .

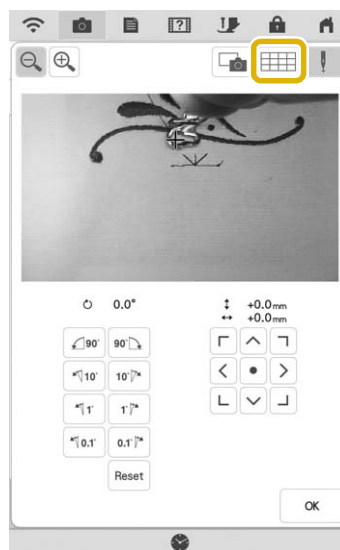



- 12** Touch the positioning keys to move the embroidery frame until the thread mark on the fabric is aligned on the starting point in the camera view window.

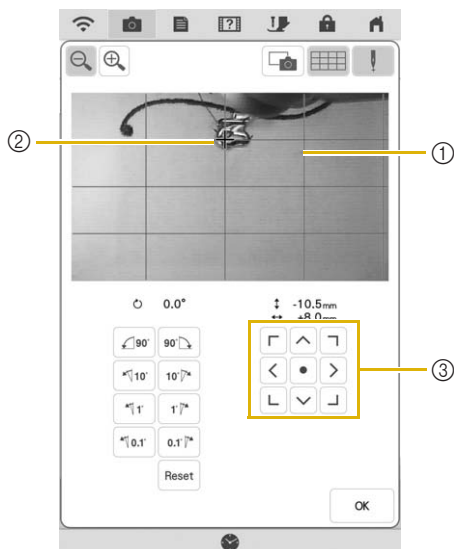

- ① Grid lines  
② Thread mark on the fabric  
③ Positioning keys

#### Memo

- Touch to enlarge the camera view. By enlarging the camera view, you can make a close adjustment for the needle drop point moving the embroidery frame little by little.

- 13** If the positioning keys cannot be used to align the embroidering position, rehoop the fabric so that the thread mark and the next pattern to be embroidered are within the embroidering area, and then try again to align the fabric by using the positioning keys.

#### Memo

- When embroidering the repeated pattern, you cannot rotate the pattern in the camera view window. If the pattern is rotated in the camera view window, you cannot embroider the pattern properly aligned even if the thread mark and the starting point are aligned in the camera view window.

- 14** Touch to return to the previous screen.

- 15** If necessary, remove the thread mark.

- 16** Press the “Start/Stop” button to begin embroidering.

## Duplicating a Pattern

- 1** Touch , and then touch .

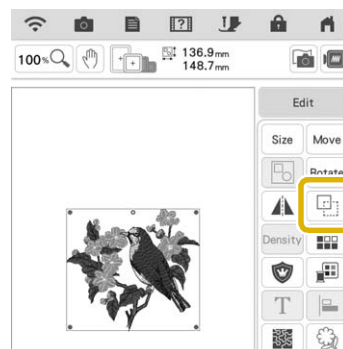

→ The duplicate is positioned.

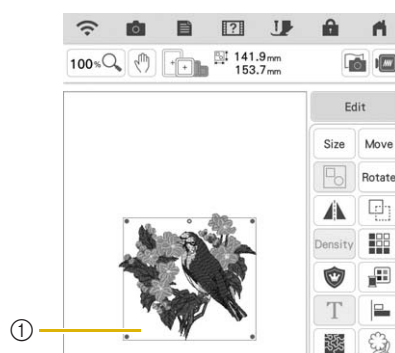

- ① Duplicated pattern

#### Memo

- If multiple patterns are displayed in the screen, only the pattern selected using and is duplicated. To select multiple patterns, refer to “Selecting Multiple Patterns at the Same Time” on page 83.
- Move and edit each duplicated pattern individually.

## Deleting the Pattern

Touch  to delete the pattern from the screen.

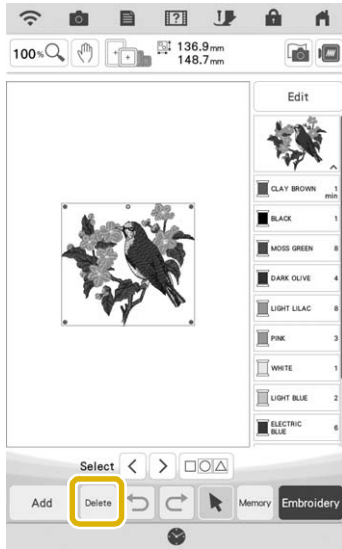

## Displaying Patterns in the Screen Magnified

1 Touch  to magnify the image.

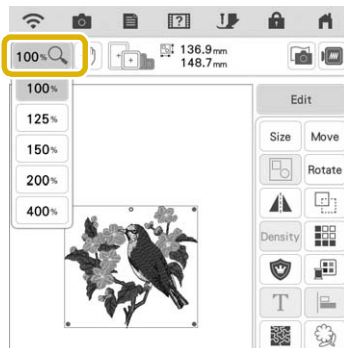

2 Check the displayed pattern.

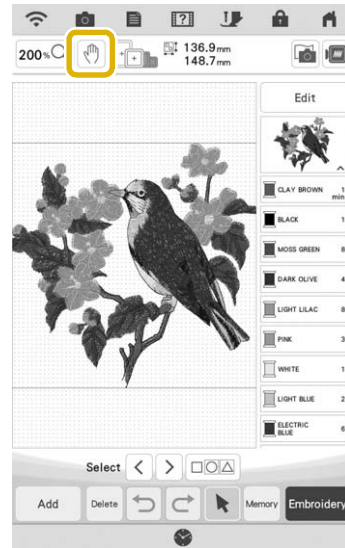

### Memo

- When magnifying, touching  enables you to move displayed area. At this time, the embroidery pattern in the location in the embroidery field does not move.

## Deselect Region Setting (No Sew Setting)

The deselect region setting (which specifies that a thread color will not be embroidered) can be applied to a part of the pattern with a specific color.

1 Touch  in the embroidering edit screen.

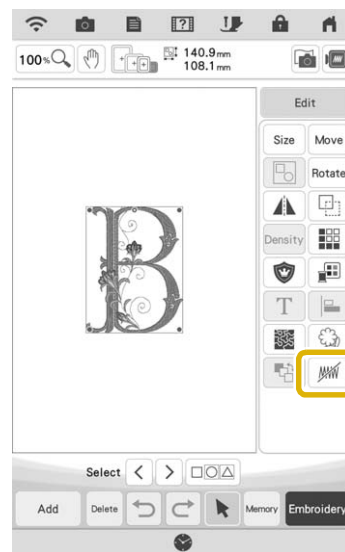

**2** From the thread color sequence display, select the thread color that will not be embroidered.

→ The selected thread color is highlighted in blue.



**3** Touch .

→ The mark  appears to indicate that the selected thread color will not be embroidered. The parts of the pattern that will not be embroidered are hidden in the pattern preview screen.

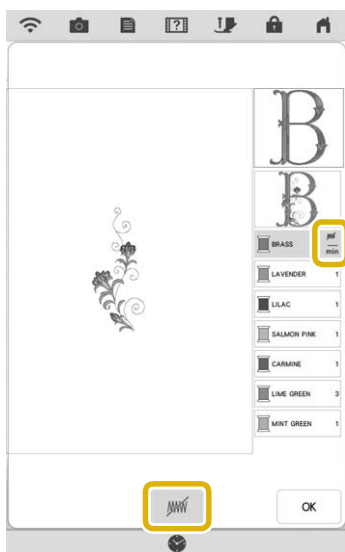



**Memo**

- To cancel the setting, select the thread color and touch .

**4** If necessary, repeat steps **2** and **3** for all thread colors that will not be embroidered.

**5** After specifying the desired settings, touch .

**6** Touch  and then touch  to check an enlarged image of the finished embroidery.

\* After deselecting a region, check the image to be sure no previously hidden stitches are visible.



**Memo**

- When a pattern with the deselect region setting applied is saved, the deselect region setting is also saved. However, the pattern cannot be saved if the deselect region setting is applied to all thread colors.
- The parts with the deselect region setting applied are merely not displayed; they are not deleted. The embroidering area required to embroider the pattern is the same as for the original pattern.



# EDITING LETTERS

## Selecting Alphabet Character Patterns

**Example:** Entering “The Sky is Blue”.

1 Touch **AA**.

2 Touch the key of the font you want to embroider.

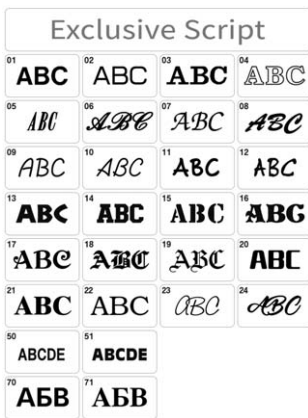

3 Touch the tab to select a character type.



4 Touch **ABC** and then enter “T”.

- \* If you want to change the size of a character, select the character and then touch **L M S** to change the size. The size changes each time you touch the key, from large to medium to small.
- \* If you make a mistake, touch **Delete** to erase the mistake.

**Memo**

- If you continue adding characters after changing the size, the new characters will be entered in the new size.

5 Touch **abc** and enter “he”.

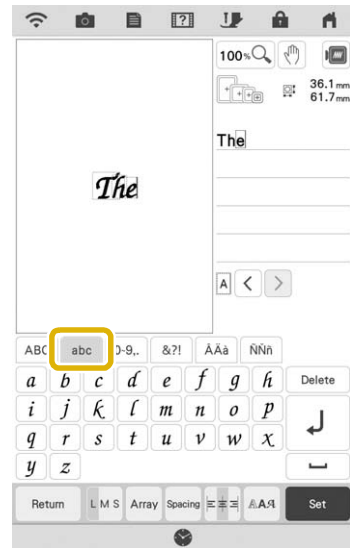

6 Touch **↵** to enter a space.



7 Touch **ABC** again and enter “S”.



8 Touch **abc** and then enter “ky\_is”.



9 Touch **↵** to make a new line.

10 Enter “Blue” according to step 4 and 5.

11 Touch **Set**.

12 Follow the steps from 4 to 7 of “Selecting Embroidery Patterns/Decorative Alphabet Patterns/Utility Embroidery Patterns” on page 40 to stitch the design.

## Character Alignment

After entering the characters but before touching **Set**, you can adjust the character alignment.

Each touch of **≡≡≡** switches between right alignment, left alignment and center alignment, in that order.



**≡≡≡** Right alignment

**≡≡≡** Left alignment

ABCDE  
FGH  
IJKLMN

ABCDE  
FGH  
IJKLMN

**≡≡≡** Center alignment

ABCDE  
FGH  
IJKLMN

### Memo

- Adding a line feed with a second line of text will disable the text editing functions described on pages 71-75.

## Changing Font Type

1 Before changing the font type, touch

**Edit**, and then touch **T**.



**2** Touch **Aa1**.

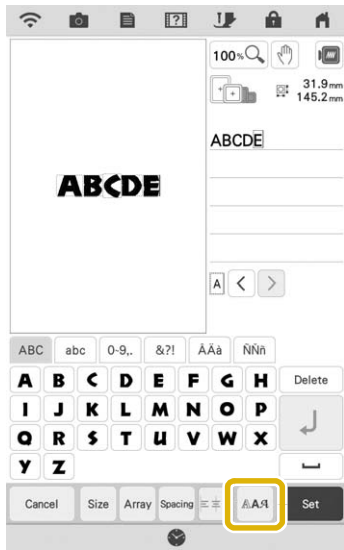

**3** Select the font type.

→ All the characters in the screen change into the selected font type.

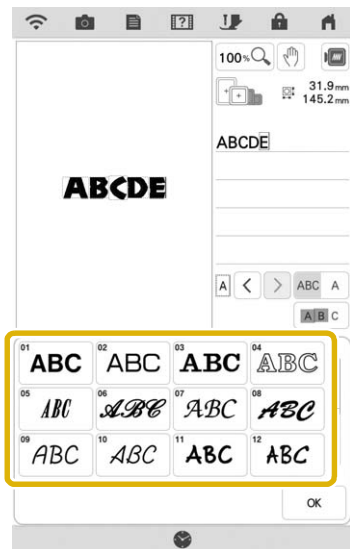

\* Scroll the bar to display the font type that is not on the screen.

**Memo**

- To change the character font type for only the selected character, touch **ABC A** so that it appears as **ABC A**. The font type of the selected character is changed.
- To select more than one character individually, touch **ABC**. Touch the character patterns to be selected. To cancel the selection, touch the character pattern again.

**4** Touch **OK**.

→ The new font is selected.

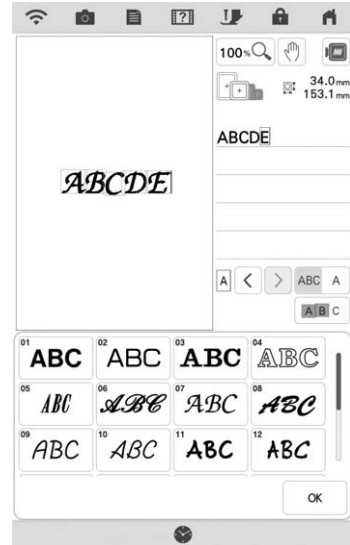

**Changing Letter Size**

**1** Touch **Edit**, and then touch **T**.



**2** Touch **Size**.

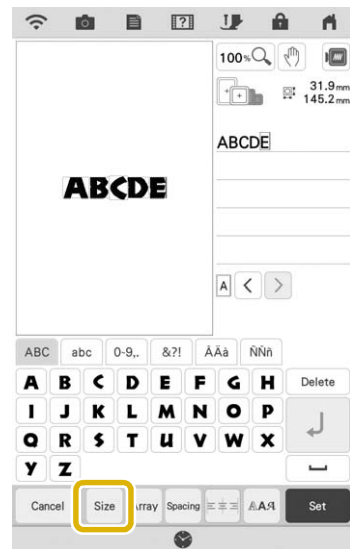



**3** Change the size of letters.

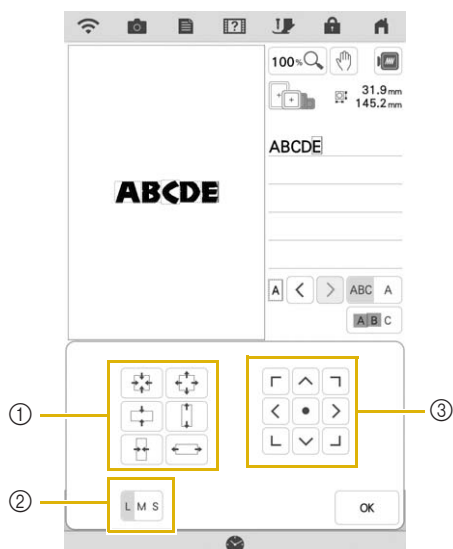

- ① Change the size to the specific direction.
- ② Change the size from L, M or S size.
- ③ Move the text.

**Memo**

- To change the character letter size for only the selected character, touch **ABC A** so that it appears as **ABC A**. The letter size of the selected character is changed.
- To select more than one character individually, touch **ABC**. Touch the character patterns to be selected. To cancel the selection, touch the character pattern again.

**4** Touch **OK**.

## Changing the Configuration of Alphabet Character Patterns

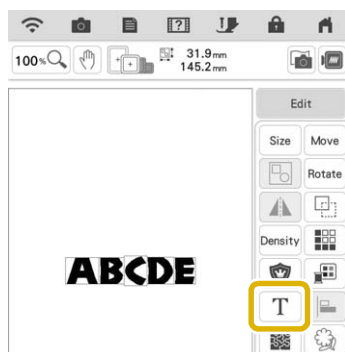

**1** Touch **Edit**, and then touch **T**.





**2** Touch **Array**.







**3** Select the layout. (Example: )

When selecting an arc, use  and  to change the degree of the arc.

- \* Touch  to make the arc flatter.
- \* Touch  to make the arc rounder.



**Memo**

- When selecting **ABC**, these keys ( and ) change to look like ( and ). So you can increase or decrease the incline.
- You can move patterns using  on the screen.

**4** Touch **OK**.

# Changing Alphabet Character Spacing

1 Touch **Edit**, and then touch **T**.

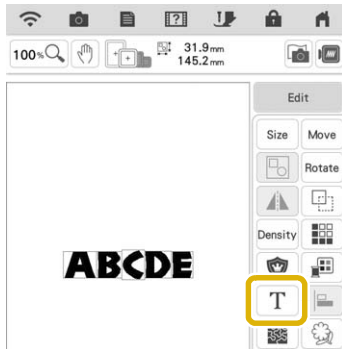

2 Touch **Spacing**.



## 3 Select the spacing.

- \* Touch **+ABC+** to increase the character spacing.
- \* Touch **-ABC-** to decrease the character spacing.
- \* Touch **ABC** to return the pattern to its original appearance.
- \* Touch **A<sup>B</sup>** to move the characters up.
- \* Touch **A<sub>B</sub>** to move the characters down.



### Memo

- To change the character spacing for only the selected character, touch **ABC A** so that it appears as **ABC A**. The spacing of the selected character is changed.



- To move the character up/down, touch **ABC A** so that it appears as **ABC A**.
- To select more than one character individually, touch **ABC**. Touch the character patterns to be selected. To cancel the selection, touch the character pattern again.

- You can move patterns using  on the screen.



**4** Touch .**Memo**

- It is not recommended to edit data and transfer to other or older version machines. Some features do not apply in other machines, so problems may occur.
- Character spacing can be reduced only when characters are arranged normally on a straight line.
- The spacing between characters can be reduced to 50% of the narrowest character in the group.

**Re-editing Character Patterns**

Even after text has been entered, the characters can be re-edited.

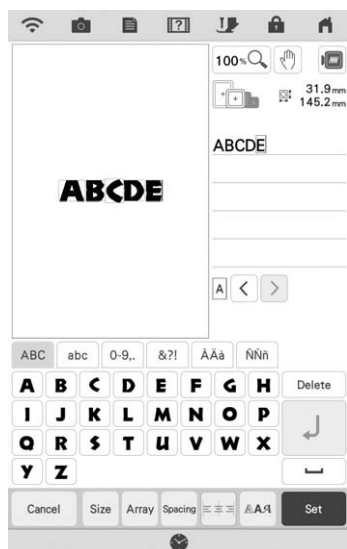
**1** Touch , and then touch .

→ The character pattern can be re-edited.

**Memo**

- A line feed cannot be added when re-editing character patterns.

# EDITING COLORS

## Changing the Thread Color

You can change the thread color by moving the color to be changed to the top of the embroidering order and selecting a new color from the thread colors in the machine.

1 Touch **Edit**, and then touch .

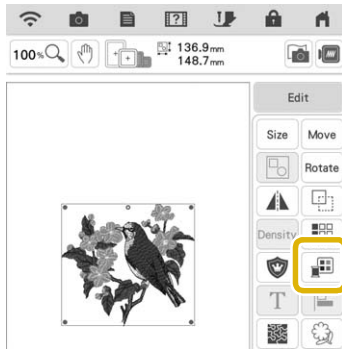

→ The thread color palette screen displays.

2 Touch the color of the part to be changed.

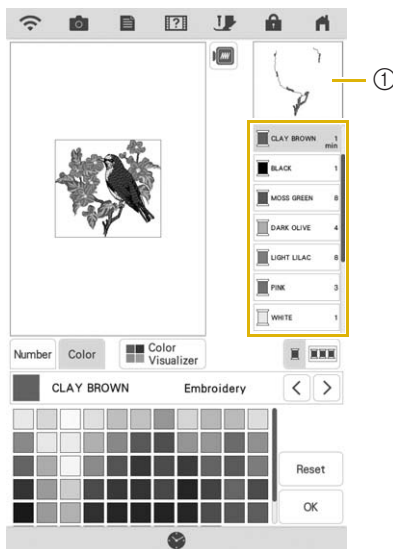

① Selected thread color image  
→ The selected thread color image is displayed.

3 Select a new color from the color palette.

\* To return to the original color, touch **Reset**. If multiple colors have been changed, this command will return all colors to their original colors.

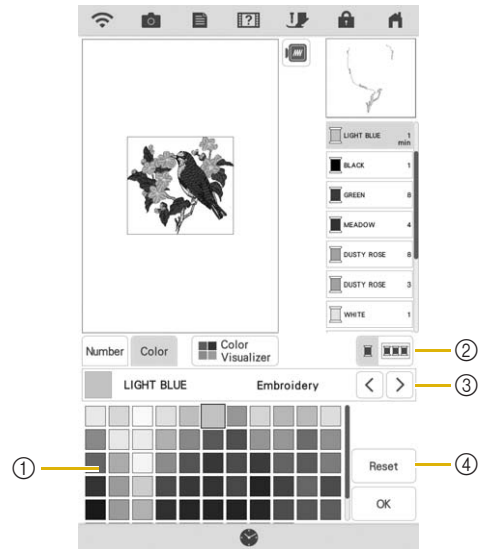

- ① Color palette
  - ② Switch between selecting a single color and selecting all colors.
  - ③ Select a different thread brand to preview the design with specific thread spools you may already have on hand.
  - ④ Revert to the original color.
- The display shows the changed colors.

4 Touch **OK**.

### Memo

- Touch **Number** to find a thread color by entering its number. If you enter the wrong number, touch **C**, and then enter the correct number. After entering the number, touch **OK**.

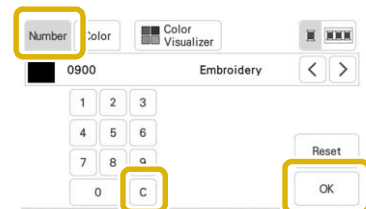

## Find New Color Schemes with the Color Visualizer Function

With the color visualizer function, the machine suggests new color schemes for the embroidery pattern that you have selected. After you select the desired effect from the four available ([Random], [Vivid], [Gradient] and [Soft]), sample color schemes for the selected effect are displayed.

**1** Touch **Edit**, and then touch .  
→ The thread color palette screen appears.

**2** Touch .

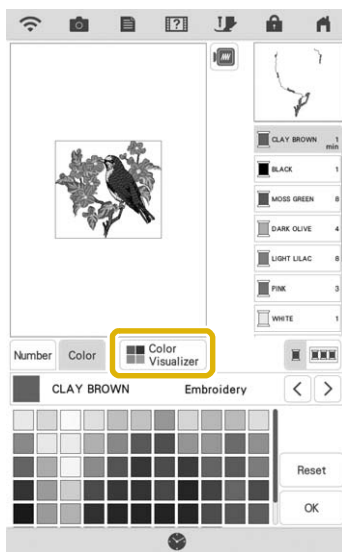

→ The color visualizer screen appears.

### Memo

- This function may not be available depending on the pattern you select (ex. a bordered embroidery pattern, licensed pattern).

**3** Select the thread brand for colors and the number of colors you want to create the pattern with.

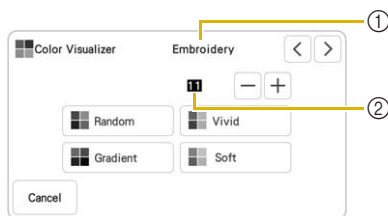

- ① Thread brand for colors
- ② Number of colors to be used.

**4** Select the desired effect.

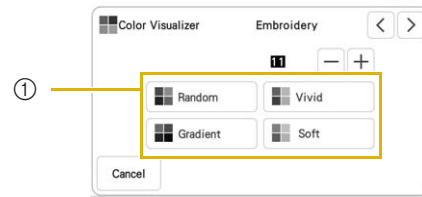

- ① Effects for schemes  
→ If you select [Random] or [Gradient], the color specifying screen will appear.  
\* If you select [Vivid] or [Soft], proceed to step **7**.

**5** Touch **Manual** and specify the thread color to use in the desired effect.

- \* If you don't need to specify the thread color, just set to **Auto**.

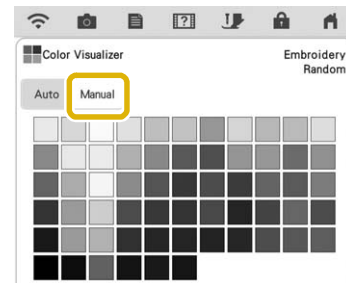

### [Manual] setting for [Random]

You can select up to 6 colors to be used in the [Random] effect. The effect will be created using the selected colors.

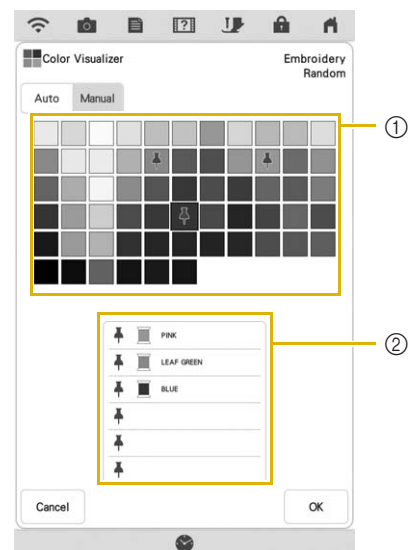

- ① Select colors from the palette.
- ② Selected colors are listed.

**[Manual] setting for [Gradient]**

You can select one color to be used in the [Gradient] effect.  
The effect will be created with a color you select.

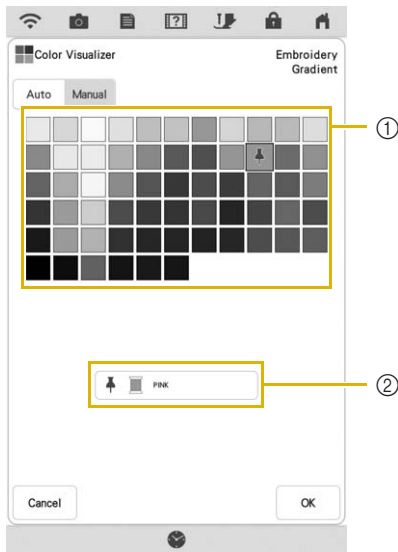

- ① Select a color from the palette.
- ② Selected color is displayed.

**6** Touch .

**7** Touch the desired color scheme from samples.

\* Touch  to display the new schemes.

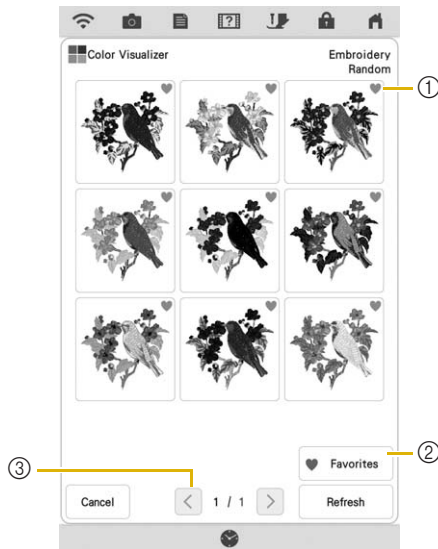

- ① Touch to temporarily register your favorite schemes. A maximum of nine color schemes can be registered as favorites. To release a favorite color scheme, touch again.

- ② Touch  to display the color scheme favorites screen. Touch to remove the color scheme on color scheme favorites screen.
- ③ Touch to review the previous schemes.

**Memo**

- Maximum 20 pages of schemes can be reviewed.

**8** Touch  to select the displayed color scheme.

- \* Touch  to return to the previous screen.
- \* You can continue selecting color schemes from the selected page prior to touching .
- \* Touch  or  to display the other color schemes.



→ The thread color palette screen will appear.

# Thread Color Sorting

This function allows you to embroider while replacing the thread spool a minimal number of times.

Before starting to embroider, touch  in the embroidery screen to rearrange the embroidery order and sort it by thread colors.

**1** Touch  in the embroidery screen.

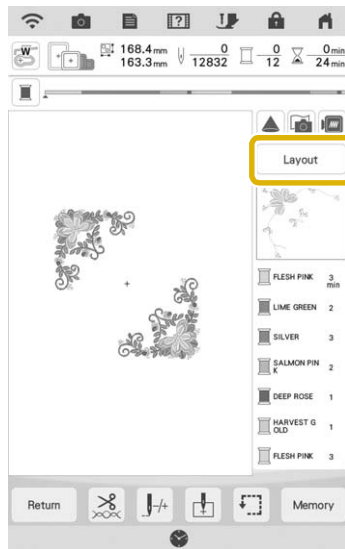

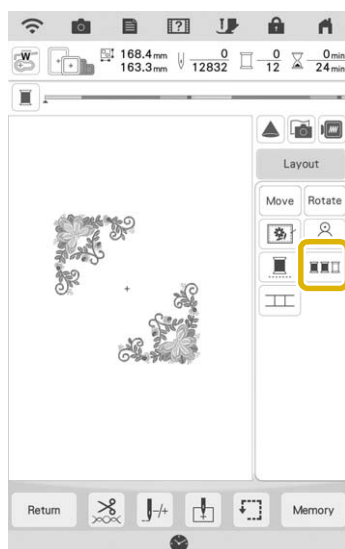

**2** Touch .

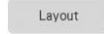

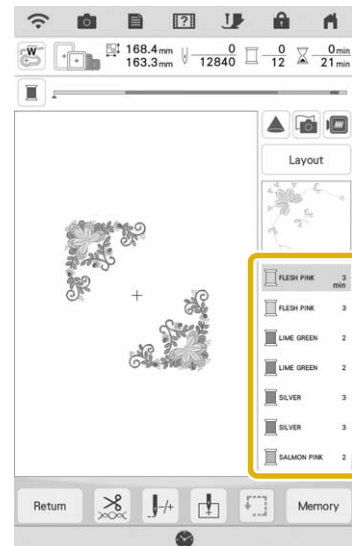
\* Touch  again to check the sorted thread colors.

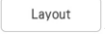

The embroidery color order is rearranged and sorted by thread colors.

Touch , then  to cancel color sorting and embroider with the original embroidery color order.

### Memo

- This function does not work on overlapping designs.

# COMBINING PATTERNS

## Editing Combined Patterns

**Example:** Combining alphabet characters with an embroidery pattern and editing.



**1** Touch  to select an embroidery pattern.

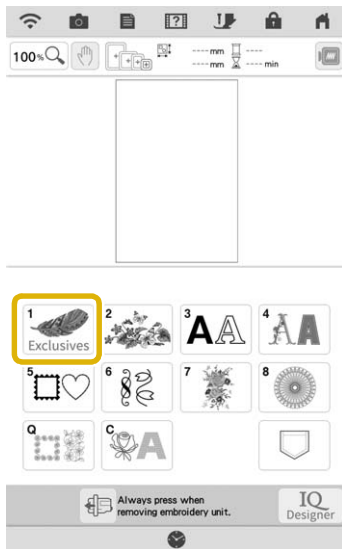

**2** Select **Monograms**, touch  and then touch **Set**.

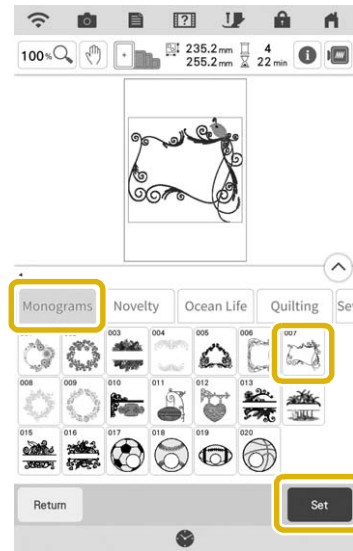

**3** Touch **Add**.

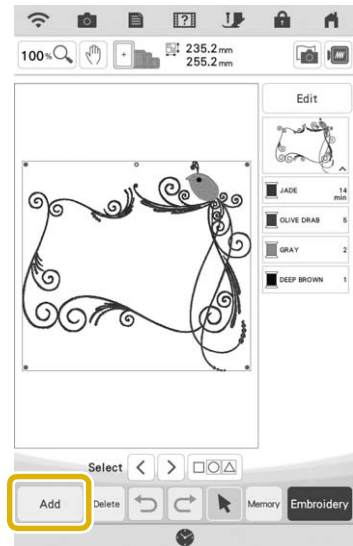

**4** Touch <sup>3</sup> **AA** to enter the alphabet characters.

\* Touch **Return** to return to the previous screen.

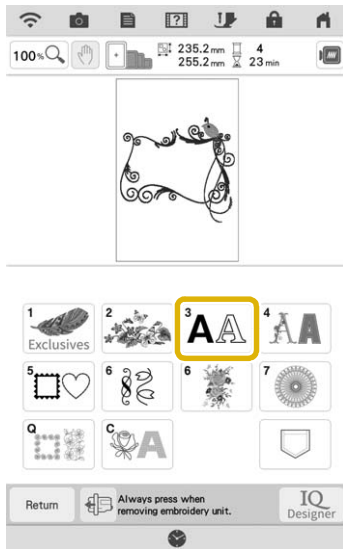

**5** Select <sup>07</sup> **ABC** and enter "LOVE".



→ The characters you enter will be displayed in the center of the display.

**6** Touch **Array** to change the layout of the characters. Touch **OK**.



\* Refer to page 73 for more information about changing the layout.

**7** Touch **Set** and then touch **Edit**.

**8** Touch **Move** and then use  to move

the characters. Touch **OK**.

\* With your finger, the included dual purpose stylus or fine tipped stylus pen, drag the characters to move them.

**9** Touch  to change the color of the characters. Touch **OK**.

\* Refer to page 76 for more information about changing the color.

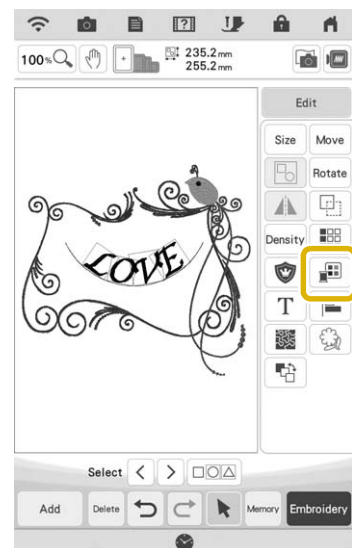



**10** When all editing is finished, touch **Embroidery**.



**Memo**

- Combined patterns will be embroidered in the order they were entered. For details on changing the embroidering order, refer to “Changing the Embroidering Order of Combined Patterns” on page 91.

**Selecting Combined Embroidery Patterns**

If multiple patterns have been combined, use **< >** to select the pattern to be edited. Patterns can also be selected by directly touching the screen with your finger, the included dual purpose stylus or fine tipped stylus pen.

**Memo**

- Use **< >** to select patterns that are overlapping and cannot be selected by touching the screen.
- When **< >** are not displayed, touch **↔**.

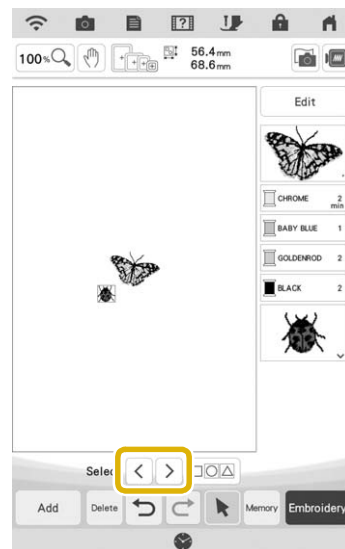
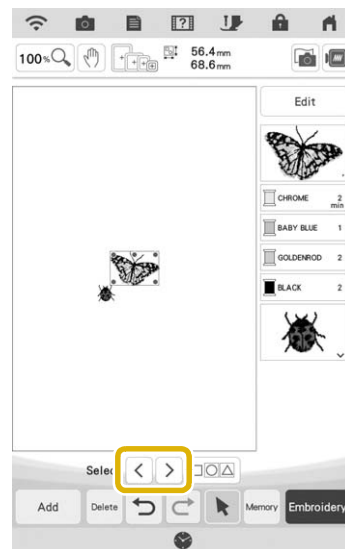





## Selecting Multiple Patterns at the Same Time

Multiple patterns can easily be edited, for example, when moving patterns that are combined, if they are all selected together.

### 1 Touch .

\* When  is not displayed, touch .



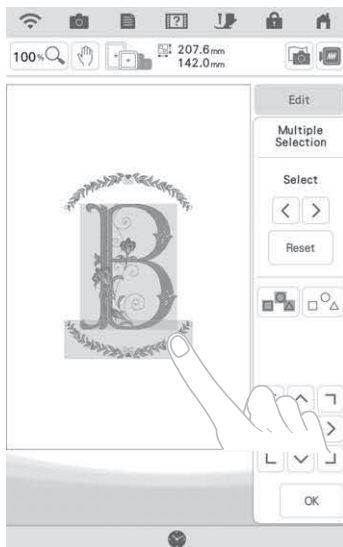

→ The Multiple Selection screen appears.

### 2 Touch each pattern to select multiple patterns.



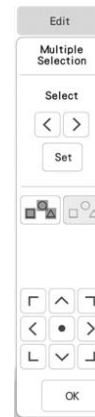

## Memo

- Multiple patterns can also be selected by dragging your finger in the screen.
- Multiple patterns can be selected or deselected from the Multiple Selection screen. Touch  or  to check the patterns to be selected, and then touch .



The selected patterns are surrounded with a red box.

- Touch  to select all patterns in the pattern display area.
- Touch  to deselect all selected patterns.
- The patterns can also be selected by touching them directly in the screen.
- While the Multiple Selection screen is displayed, patterns can be moved with .
- Some editing keys appear in light gray and are not available while multiple patterns are selected.

### 3 Touch to return to the embroidery edit screen.

\* Each selected pattern is surrounded with a red box.

## Grouping Multiple Selected Patterns

If the multiple patterns selected in “Selecting Multiple Patterns at the Same Time” on page 83 are grouped, they can be edited as a single pattern.

- 1 Touch .
- 2 Touch each pattern to select multiple patterns and then touch .
- 3 Touch .

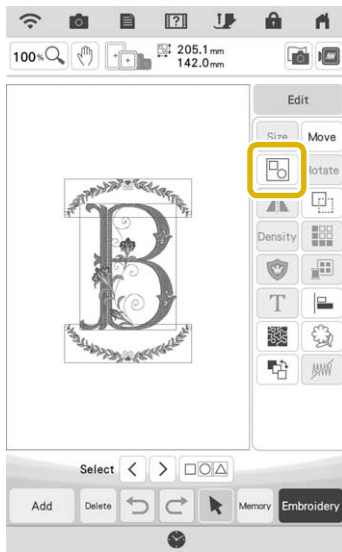

- The selected patterns are grouped.
- \* Touch  to ungroup the patterns. If there are multiple grouped patterns, the selected pattern group is ungrouped.

### Memo

- When patterns are grouped, the following functions are applied to all patterns in the pattern group.
  - Moving
  - Rotating
  - Border
  - Appliqué
  - Thread color changing
  - Stippling, echo quilting, decorative fill
  - Extracting pattern outlines

## Aligning the Embroidery Patterns

- 1 Touch  and then touch .

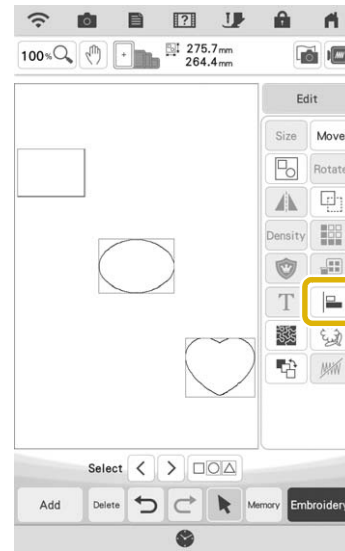

- 2 Touch each pattern that you want to align.

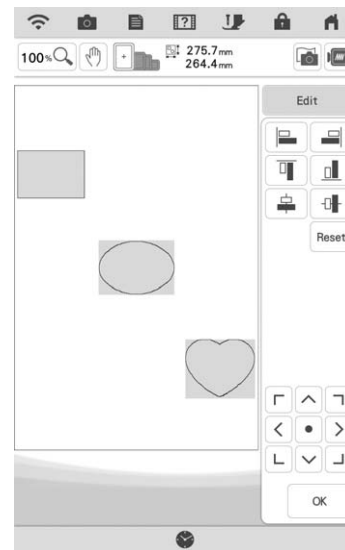

- 3 Touch the key for the desired alignment.

Example:

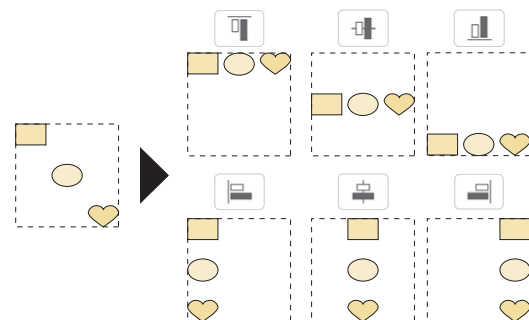



Chapter **3**

# Advanced Editing

# VARIOUS EMBROIDERING FUNCTIONS

## Uninterrupted Embroidering (Using a Single Color: Monochrome)

A selected pattern can be stitched out in one color instead of multicolor. The machine will continue stitching without stopping for thread changes until the pattern is completed.

1 In the embroidery screen, touch  .

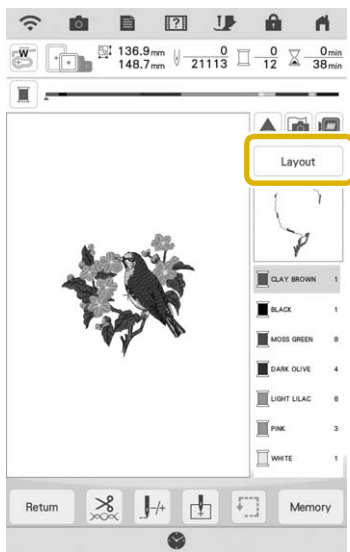

2 Touch  .

\* Touch the key again to return to the original setting.

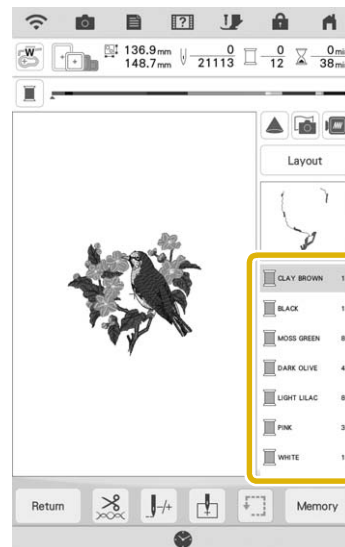
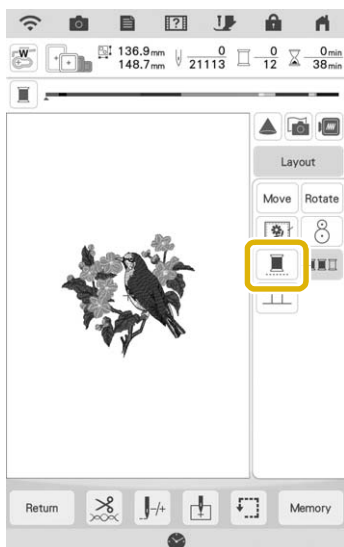

→ The thread color displayed on the screen will be grayed out.

### Memo

- Even if uninterrupted embroidering  has been set, the automatic thread cutting function and the thread trimming function can be used. (page 95, page 96)

## Display the Fabric while Aligning the Embroidering Position

The fabric hooped in the embroidery frame can be displayed on the LCD so that the embroidery position can be easily aligned.

Example:

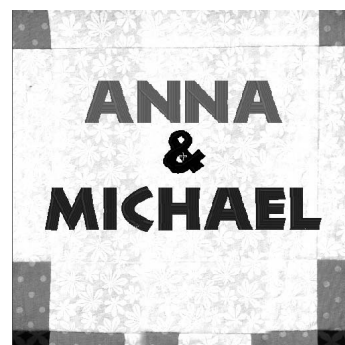

### Memo

- When embroidery frame (small: H 20 mm × W 60 mm (H 1 inch × W 2-1/2 inches)) is installed, this function cannot be used.
- For details on using thicker fabric such as quilting, refer to “Positioning the Pattern on Thick Fabric” on page 89.

- 1 Hoop the fabric in the embroidery frame, and then attach the frame to the machine.
- 2 Select the pattern and, if necessary, edit the pattern and touch **Embroidery**.

**Note**

- When using light to medium weight fabrics, check the settings screen to make sure [Fabric Thickness Sensor] is set to [OFF].

- 3 Touch .

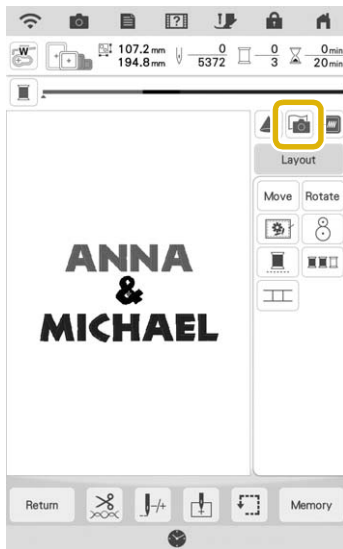

- 4 Touch **Scan**.

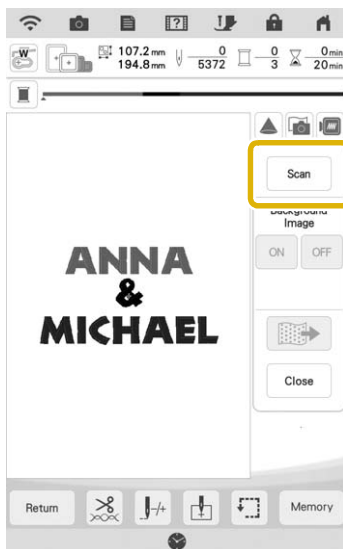

- 5 When the following message appears, touch **OK**.

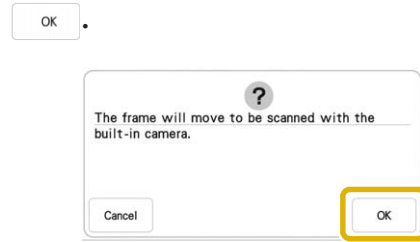

→ The carriage moves so the fabric can be scanned.

**Memo**

- If you do not wish the upper thread to be scanned together with the fabric, scan the fabric without the needle threaded with the upper thread.
- The density of the scanned background image can be adjusted.

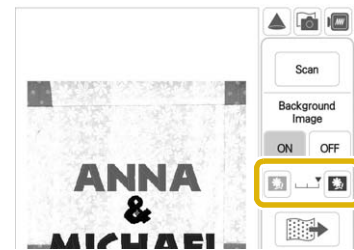

- 6 When the fabric appears as a background for the pattern, touch **Close** then **Layout** to display the editing window.

- \* The pattern can be moved to the desired position by dragging on the screen using your finger, the included dual purpose stylus or fine tipped stylus pen without displaying the editing window. If you need some fine adjustment, move the pattern from the editing window.

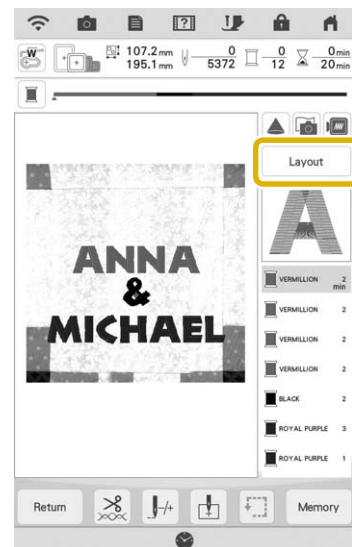

**7** Touch **Move** to display the pattern moving window.



**8** Use  to align the pattern to the desired embroidery position.

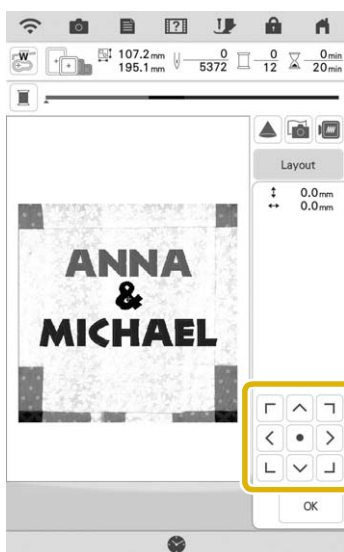

**9** Touch **OK**.

**Memo**

- The pattern can also be rotated for best alignment with the scanned background fabric.
- If necessary, touch  to display a preview in order to check the pattern position.

**10** Press the “Start/Stop” button to start embroidering.

\* Refer to “Embroidering Patterns” on page 50.

→ When embroidery is finished, the fabric displayed in the background disappears.

**Note**

- The fabric will appear in the background until embroidering of the pattern is finished. In order to show or hide the background image, touch , and then set [Background Image] to [ON] or [OFF].

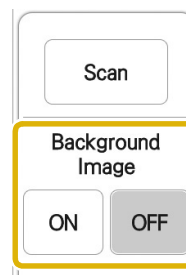

- To completely remove the background image, refer to “Specify Fabric Display from the Settings Screen” on page 88, and then delete the background image with the settings screen.

**Specify Fabric Display from the Settings Screen**

With the settings screen, the quality of the background image can be set, or the scanned image can be deleted.

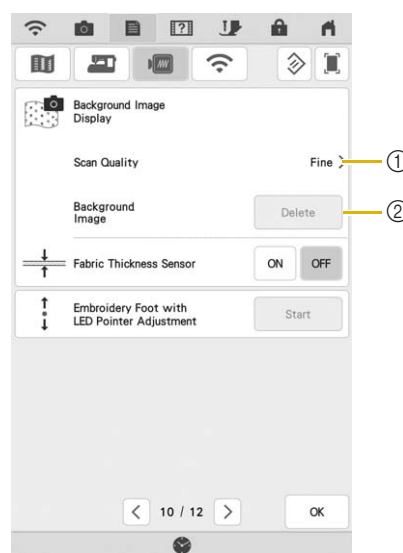

- ① Set to [Fine] to scan clearer than setting to [Standard].
- ② Touch **Delete** to remove the background image completely.

## ■ Saving Scanned Image to USB Media

- 1 Insert the USB media into the USB port on the machine.

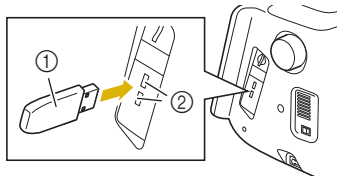

- ① USB media
- ② USB port

- 2 Touch and select the USB port to save image.
- 3 Touch the key for the corresponding media to save the file.  
→ The image file will be saved to the USB media.
- 4 Remove the USB media, and then check the saved image using a computer.  
→ The files for scanned images are saved in a folder labeled [bPocket].

## ■ Positioning the Pattern on Thick Fabric

When positioning the pattern on thick fabric such as quilting, the fabric may not be detected correctly. In order for the fabric to be correctly detected, its thickness must first be measured.

### Memo

- This feature is functional only when the fabric is scanned. It will not affect embroidering if it is turned on with normal embroidering.

- 1 Hoop the fabric in the embroidery frame, and then attach the frame to the machine.
- 2 Select the pattern and, if necessary, edit the pattern and touch .

- 3 Display page 10 of the settings screen, and then set [Fabric Thickness Sensor] to [ON].

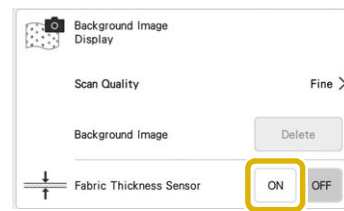

- 4 Touch .

- 5 Touch .

- 6 Touch .

- 7 Affix the embroidery positioning sticker to the fabric within the area indicated by the red frame displayed with the projector, and then touch .

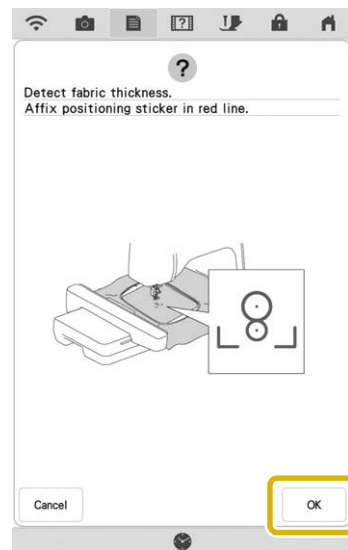

- 8 When the following message appears, remove the embroidery positioning sticker, and then touch .

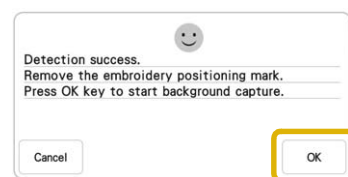

→ The carriage is moved, and the embroidery positioning sticker affixed to the fabric is detected.

- 9 Continue with step 6 on page 87 to align the pattern with the desired embroidery position.



## Basting Embroidery

Before embroidering, basting stitches can be sewn along the outline of the pattern. This is useful for embroidering fabric that cannot have stabilizer material affixed with an iron or adhesive. By stitching stabilizer material to the fabric, shrinkage of the stitching or misaligned pattern can be minimized.

**Note**

- It is recommended to finish combining and editing the pattern before selecting the basting setting. If the pattern is edited after selecting the basting setting, the basting and pattern may become misaligned, and the basting under the pattern may be difficult to remove after embroidering is complete.

**1** Touch .

**2** Touch the number to specify the distance from the pattern to the basting stitching.

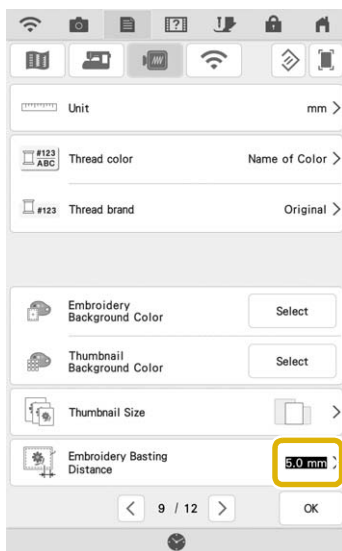

**Memo**

- The higher the setting, the farther the basting is from the pattern.
- The setting remains selected even if the machine is turned off.

**3** Touch  to return to the previous screen.

**4** Touch , and then touch  to select the basting setting.

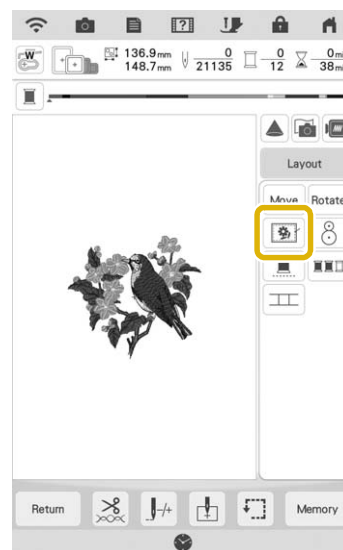

**Memo**

- To cancel the setting, touch .

→ Basting is added to the beginning of the embroidering order.

**5** Press the “Start/Stop” button to begin embroidering.

**6** When embroidering is finished, remove the basting stitching.





## Changing the Embroidering Order of Combined Patterns

The embroidering order of combined patterns can be changed.

- 1 Select a pattern, add additional pattern(s), adjust the layout of the patterns, and then display the editing window.
- 2 If necessary, touch  to ungroup the pattern.

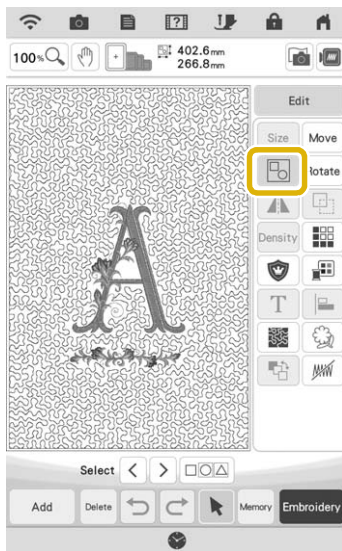

### Memo

- The embroidering order for grouped patterns is changed group by group. To change the embroidering order of a pattern within a group, ungroup the pattern first.

- 3 Touch .

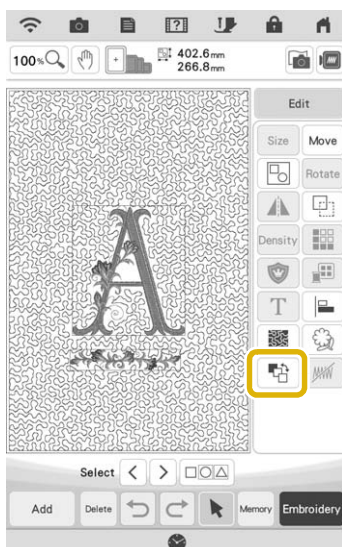

→ The embroidering order change screen appears.

- 4 Select the pattern whose order is to be changed, and then touch a key to change its position in the embroidering order.

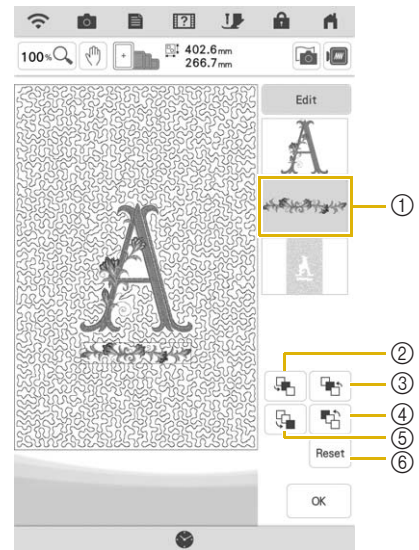

- ① Selected pattern
- ② Move the selected pattern ahead one position in the embroidery order.
- ③ Move the selected pattern back one position in the embroidery order.
- ④ Move the selected pattern to the beginning of the embroidery order.
- ⑤ Move the selected pattern to the end of the embroidery order.
- ⑥ Revert to the original embroidering order.

### Memo

- To cancel the selection of the pattern, select another pattern.
- The positions of overlapping patterns can be checked in the preview on the left side of the screen.

- 5 Touch .

# MAKING EMBROIDERY ADJUSTMENTS

## Adjusting Thread Tension

When embroidering, the thread tension should be set so that the upper thread can slightly be seen on the wrong side of the fabric.

### Correct Thread Tension

The pattern can be seen from the wrong side of the fabric. If the thread tension is not set correctly, the pattern will not finish well. The fabric may pucker or the thread may break.

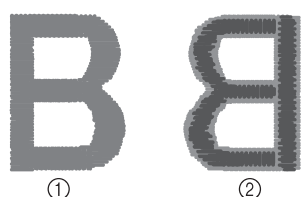

- ① Right side
- ② Wrong side
- \* Light gray color represents upper thread.
- \* Dark gray color represents bobbin thread.

Follow the operations described below to adjust thread tension according to the situation.

#### Note

- If the thread tension setting is made extremely loose, the machine may stop during embroidering. This is not the sign of a malfunction. Increase the thread tension slightly, and begin embroidering again.

### Upper Thread is Too Tight

The tension of the upper thread is too tight, resulting in the bobbin thread being visible from the right side of the fabric.

#### Note

- If the bobbin thread was incorrectly threaded, the upper thread may appear to be too tight. In this case, refer to “Setting the Bobbin” on page 19 and rethread the bobbin thread.

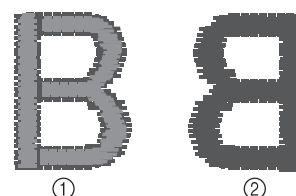

- ① Right side
- ② Wrong side
- \* Light gray color represents upper thread.
- \* Dark gray color represents bobbin thread.

### 1 Touch .

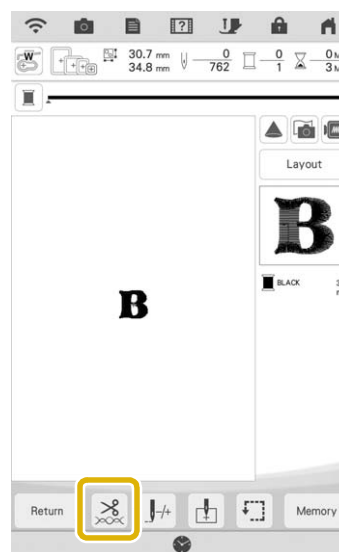

- 2 Touch **-** to loosen the upper thread tension. (The tension number will decrease.)

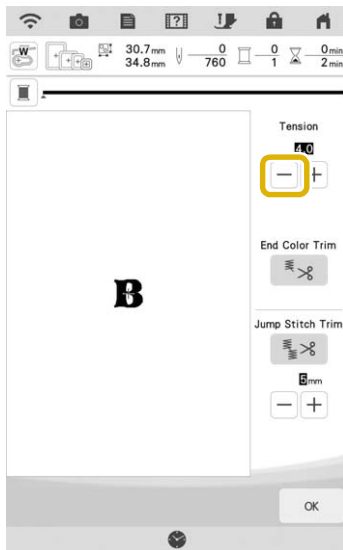

- 3 Touch **OK**.

### Upper Thread is Too Loose

The tension of the upper thread is too loose, resulting in a loose upper thread, loose thread locks, or loops appearing on the right side of the fabric.

#### Note

- If the upper thread was incorrectly threaded, the upper thread may appear to be too loose. In this case, refer to “Upper Threading” on page 21 and rethread the upper thread.

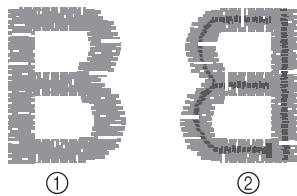

- ① Right side
- ② Wrong side

- \* Light gray color represents upper thread.
- \* Dark gray color represents bobbin thread.

- 1 Touch **✂**.

- 2 Touch **+** to tighten the upper thread tension. (The tension number will increase.)

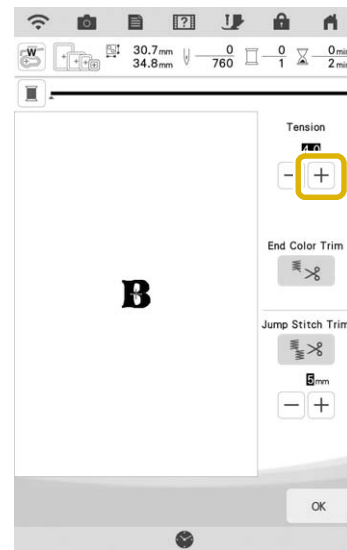

- 3 Touch **OK**.

#### Memo

- The tension of the upper thread can be adjusted for embroidering on page 8 of the embroidery settings screen. The selected setting will be applied to all patterns. When embroidering, if the overall tension of the upper thread is too tight or too loose, adjust it from the setting screen. Increase the number to tighten the upper thread and decrease the number to loosen the upper tension.



### Adjusting Overall Upper Thread Tension

When embroidering, if the overall tension of the upper thread is too tight or too loose, adjust it from the setting screen.

If an individual embroidery pattern needs additional fine tuning, refer to “Adjusting Thread Tension” on page 92.

- 1 Touch **☰**, and then touch **⚙**.

**2** In the [Embroidery Tension], touch the number to adjust the upper thread tension.

- \* Increase to tighten the upper thread tension.
- \* Decrease to loosen the upper thread tension.

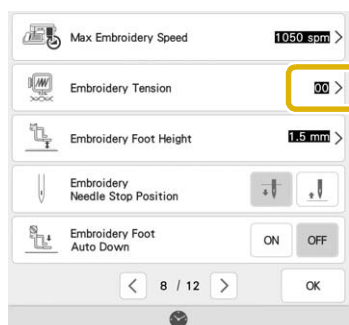

**3** Touch .

### Adjusting the Alternate Bobbin Case (with No Color on the Adjusting Screw)

When using the embroidery bobbin thread provided, please be sure to choose the green marked bobbin case when performing utility stitch sewing and embroidery functions. When in the embroidery function mode, the alternate bobbin case (with no color on the screw) should be selected when substitute embroidery bobbin threads (other than what is packaged with your machine) are being used. The alternate bobbin case (with no color on the screw) can be easily adjusted when bobbin tension changes are required to accommodate different bobbin threads. For details, refer to “Embroidering Attractive Finishes” on page 49.

To adjust the bobbin tension for embroidery function, using the alternate bobbin case (with no color on the screw), turn the slotted screw (-) with a (small) screwdriver.

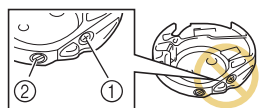

- ① Do not turn the phillips screw (+).
- ② Adjust with a screwdriver (small).

### Correct Tension

Upper thread slightly appears on the wrong side of fabric.



- ① Right side
- ② Wrong side
- \* Light gray color represents upper thread.
- \* Dark gray color represents bobbin thread.

### Bobbin Thread is Too Loose

Bobbin thread appears slightly on the right side of fabric.

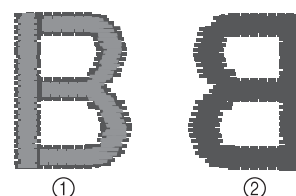

- ① Right side
- ② Wrong side
- \* Light gray color represents upper thread.
- \* Dark gray color represents bobbin thread.

If this occurs, turn the slotted screw (-) clockwise, being careful not to over-tighten the screw, approximately 30-45 degrees to increase bobbin tension.

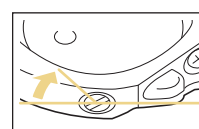

## ■ Bobbin Thread is Too Tight

Upper thread on the right side of fabric seems to be lifting/looping and bobbin thread is not seen on the wrong side of fabric.



- ① Right side
- ② Wrong side
- \* Light gray color represents upper thread.
- \* Dark gray color represents bobbin thread.

If this occurs, turn the slotted screw (-) counterclockwise, being careful not to over-loosen the screw, approximately 30-45 degrees to decrease bobbin tension.

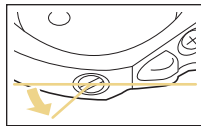



## IMPORTANT

- DO NOT adjust the position of the phillips (+) screw on the alternate bobbin case as this may result in damage to the bobbin case, rendering it unusable.
- If the slotted screw (-) is difficult to turn, do not use force. Turning the screw too much or providing force in either (rotational) direction may cause damage to the bobbin case. Should damage occur, the bobbin case may not maintain proper tension.

### Note

- When adjusting the alternate bobbin case, be sure to remove the bobbin from the alternate bobbin case.

## Using the Automatic Thread Cutting Function (End Color Trim)

The automatic thread cutting function  will cut the thread at the end of embroidering each color. This function is initially turned ON. To turn this function OFF, touch  key and then .

\* This setting returns to its default  when the machine is turned off.

### 1 Touch .

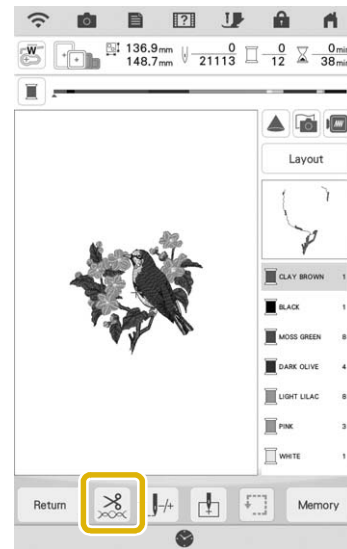

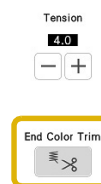

### 2 Touch to turn off the automatic thread cutting function.



→ The key will display as . When one color thread is embroidered, the machine will stop without cutting the thread.

## Using the Thread Trimming Function (Jump Stitch Trim)

The thread trimming function  will automatically trim any excess thread jumps within the color. This function is initially turned ON. To turn this function OFF, touch  key and then



\* Your customized setting remains after turning the machine off and on.

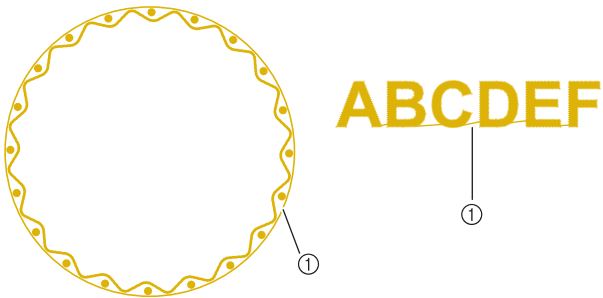

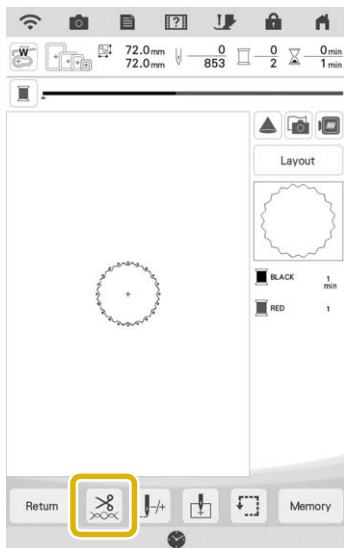

① Jump stitch

1 Touch .

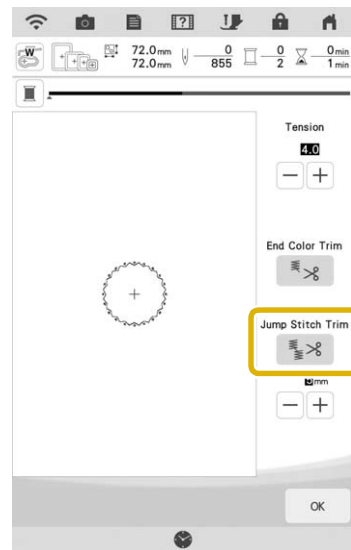

2 Touch  to turn off the thread trimming function.





→ The key will display as . The machine will not trim the thread before moving to the next stitching.

## Selecting the Trim Function to Adjust Jump Stitch Length

When the thread trimming function  is turned on, you can select the length of the jump stitch. Stitches below the value will not be trimmed.

\* Your customized setting remains after turning the machine off and on.

Touch  or  to select the length of jump stitch.

For example: Touch  to select 25 mm (1 inch) and the machine will not trim a jump stitch of 25 mm or less before moving to the next stitching.



### Memo

- If design has many trims, it is recommended to select a higher jump stitch trim setting in order to reduce the amount of excess tails on backside of fabric.
- The higher number of the jump stitch length selected, the fewer number of times the machine will trim. In this case, more jump stitches remain on the surface of the fabric.



## Adjusting the Embroidery Speed

1 Touch , and then touch .

2 In the [Max Embroidery Speed], touch the number to change the maximum embroidery speed.

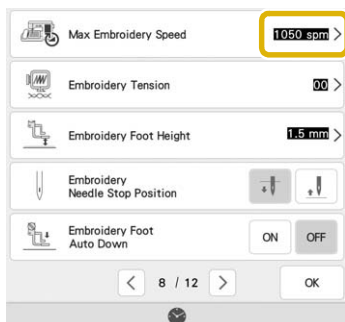

### Memo

- SPM is the number of stitches embroidered in one minute.
- Decrease the embroidery speed when embroidering on thin, thick, or heavy fabrics and when using a specialty thread like a metallic thread.
- The embroidery speed can be changed while embroidery is being done.
- The setting specified before the main power is set to OFF remains selected the next time that the machine is turned ON.

3 Touch .

## Changing the Thread Color Display

You can display the name of the thread colors or embroidery thread number.

### Memo

- Colors on the screen may vary slightly from actual spool colors.
- [Original] is set as a default and will retain the brand thread used by the designer who created the pattern.

1 Touch , and then touch .

2 In the [Thread color], select [Name of Color] or [#123] (thread number).

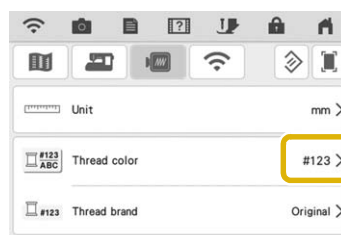

3 Select a thread brand.

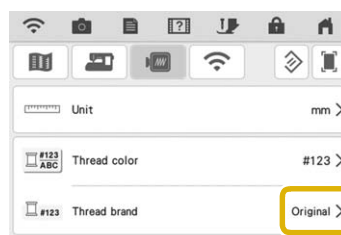

### Memo

- The thread brand setting is reflected the next time a pattern is imported.

4 Touch .

## Changing the Embroidery Frame Display

1 Touch , and .

2 In the [Embroidery Frame Display], touch  to change the embroidery frame display mode.

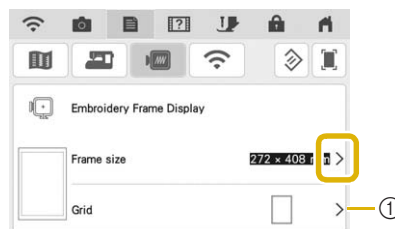

① Change the center point marker or grid lines.

3 Touch .

## Aligning the Pattern and the Needle

**Example:** Aligning the lower left side of a pattern and the needle.

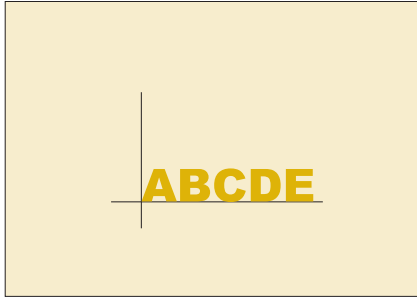

**1** Mark the embroidery start position on the fabric, as shown.

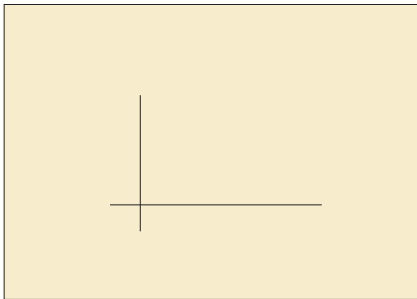

**2** Touch .

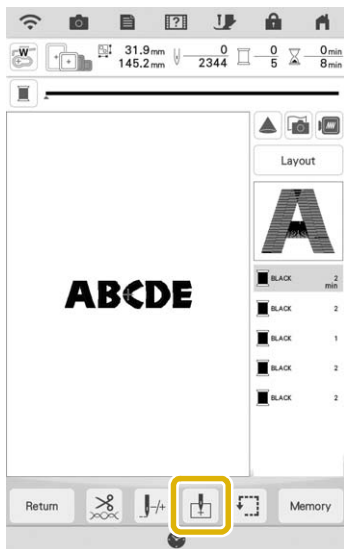

**3** Touch  then touch .

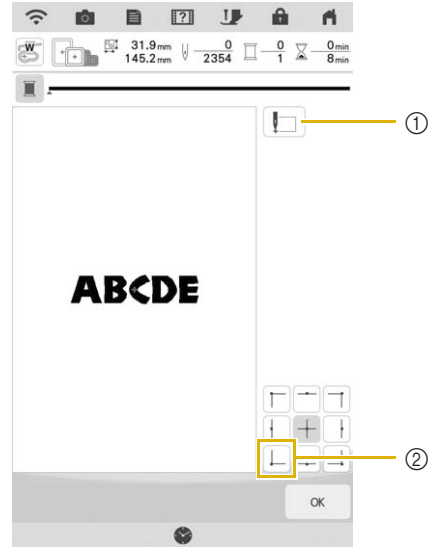

- ① This key is used for aligning linked characters. (page 99)
- ② Start position  
→ The carriage moves so that the needle is positioned correctly.

**4** Touch , and then touch .

**5** Use  to align the needle and the mark on the fabric, and begin embroidering the pattern.

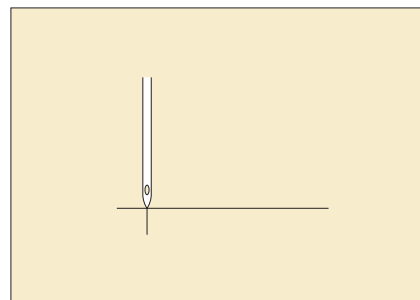

 **Memo**

- You can use camera positioning function. For details, refer to “Aligning the Embroidering Position Using the Built-In Camera” on page 43.



## Embroidering Linked Characters

Follow the procedure described below to embroider linked characters in a single row when the entire pattern extends beyond the embroidery frame.

**Example:** Linking "FG" to the characters "ABCDE"

**A B C D E F G**

**1** Select the character patterns for "ABCDE".

### Memo

- For details on selecting character patterns, refer to "Selecting Alphabet Character Patterns" on page 70.

**2** On the embroidery screen, touch .

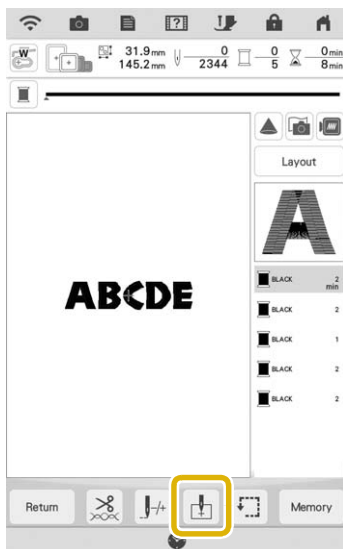

**3** Touch .

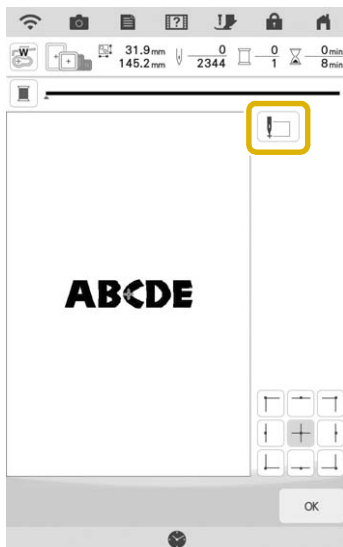

→ The needle is positioned in the lower-left corner of the pattern. The carriage moves so that the needle is positioned correctly.

### Memo

- To cancel the starting point setting and return the starting point to the center of the pattern, touch .





- Use  to select a different starting point for embroidering.

**4** Touch .

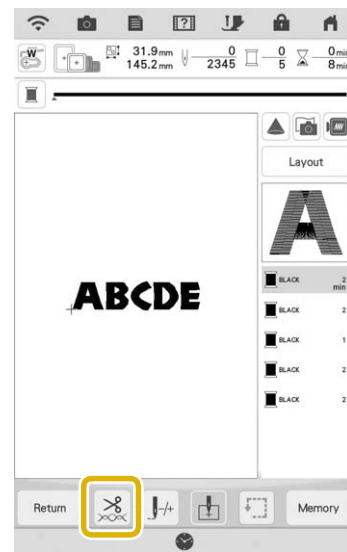
**5** Touch .



**6** Touch  to turn off the thread cutting function and then touch .

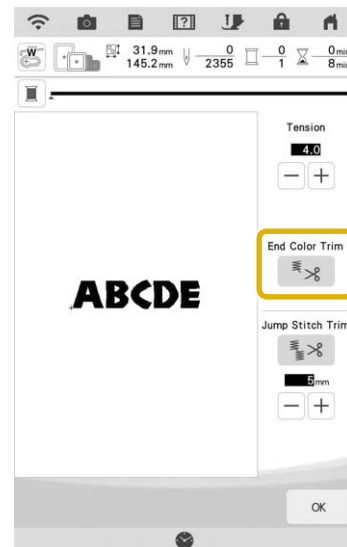

**7** Press the "Start/Stop" button.

- 8** After the characters are embroidered, cut the threads to a generous length, remove the embroidery frame, rehoop the fabric so that the remaining characters (“FG”) can be embroidered, and then attach the embroidery frame again.

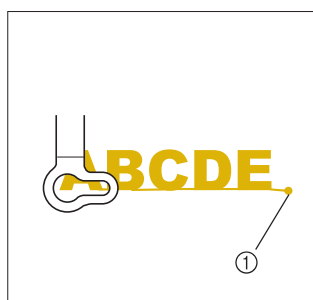

① End of the embroidering

- 9** As in step ①, select the character patterns for “FG”.

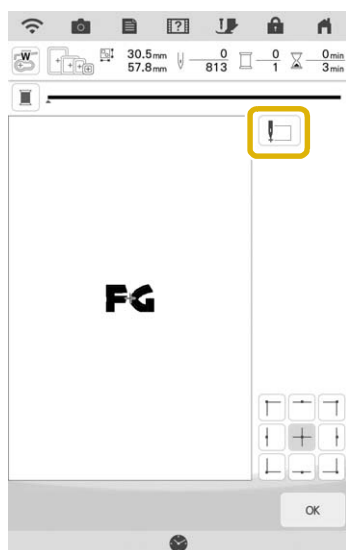

- 10** Touch .

- 11** Touch .



→ The carriage moves so that the needle is positioned in the lower-left corner of the pattern. You will need to match this point to the end of embroidering for the previous pattern.

- 12** Touch .

- 13** Touch , then  to align the needle with the end of embroidering for the previous pattern.

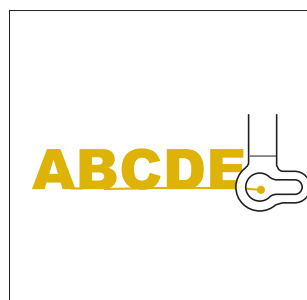

- 14** Press the “Start/Stop” button to begin embroidering the remaining character patterns.



 **Memo**

- You may want to use the camera positioning function (with the grid displayed) to ensure the next set of characters are precisely aligned with the first set of characters. For details, refer to “Aligning the Embroidering Position Using the Built-In Camera” on page 43.

# USING THE MEMORY FUNCTION

**Memo**

- For more information about the memory function, refer to “SPECIFICATIONS” in the Instruction and Reference Guide (Sewing).

## Saving Embroidery Patterns

**Note**

- Do not turn the main power to OFF while the [Saving...] screen is displayed. You will lose the pattern you are saving.

- 1 Touch **Memory** when the pattern you want to save is in the embroidery screen.

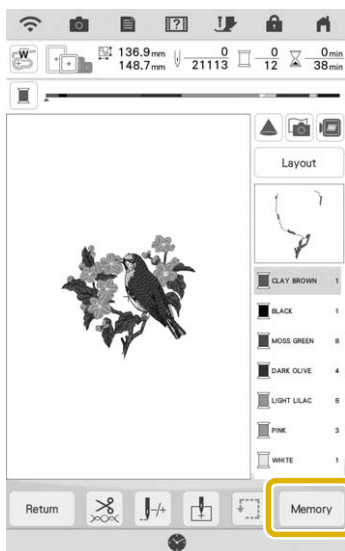

**Memo**

- You can also save the pattern by touching **Memory** in the embroidery edit screen.

- 2 When saving the embroidery pattern in a USB media/SD card, insert the USB media/SD card into the USB port/SD card slot on the machine.

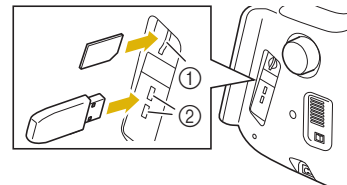

- ① SD card slot
- ② USB port

# 3

**IMPORTANT**

- Do not insert anything other than USB media into the USB media port. Otherwise, damage to the machine may result.
- Do not insert anything other than SD card into the SD card slot. Otherwise, damage to the machine may result.

Advanced Editing

- 3 Select the destination to start saving.

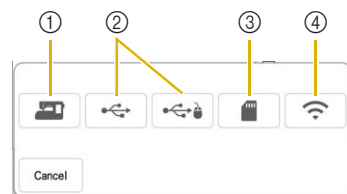

- ① Save to the machine's memory.
- ② Save to the USB media.  
The pattern is saved in a folder labeled [bPocket].
- ③ Save to the SD card.  
The pattern is saved in a folder labeled [bPocket].
- ④ Temporarily save to the wireless function pocket.  
For the detailed procedure, refer to the manual for Palette (version 11 or later).

### ■ If the Memory Is Full

If the screen below displays, either the maximum number of patterns have been saved or the pattern you want to save takes a lot of memory, and the machine cannot save it. Refer to “Retrieving Embroidery Patterns” on page 102.

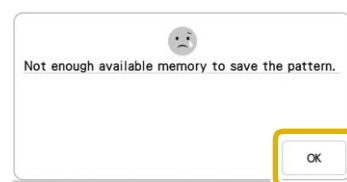

## Retrieving Embroidery Patterns

**1** When retrieving the embroidery pattern from a USB media/SD card, insert the USB media/SD card into the USB port/SD card slot on the machine.

To retrieve embroidery patterns via wireless network, use Palette (version 11 or later) or Design Database Transfer in advance. For details on transferring embroidery patterns, refer to the manual for Palette or Design Database Transfer.

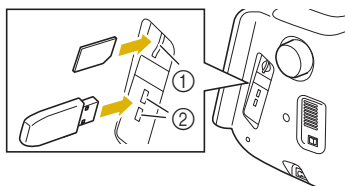

- ① SD card slot
- ② USB port

**2** Touch .

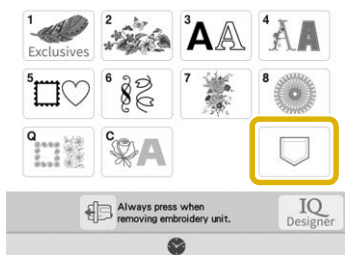

**3** Touch the desired source.

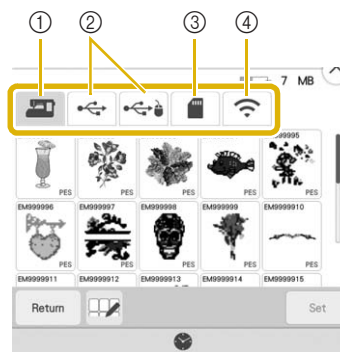

- ① Retrieve from the machine's memory.
- ② Retrieve from a USB media.
- ③ Retrieve from a SD card.
- ④ Retrieve embroidery patterns uploaded to the wireless function pocket via wireless network. For the detailed procedure, refer to the manual for Palette (version 11 or later) or Design Database Transfer.

### Memo

- If the embroidery pattern to be retrieved is in a folder of the USB media or SD card, touch the key for that folder.

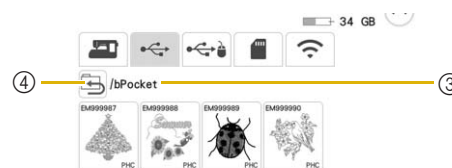
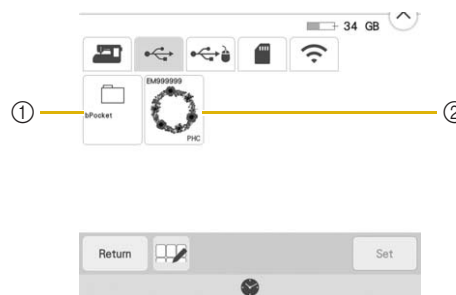

- ① Folder name
- ② Embroidery patterns in USB media/SD card
- ③ Path
- ④ Touch  to return to the previous folder.

**4** Touch the key of the pattern you want to retrieve.

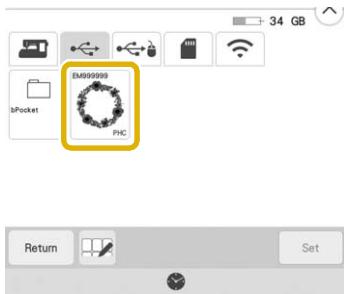

**Memo**

- By touching , the selected patterns can be deleted or saved to the machine's memory.

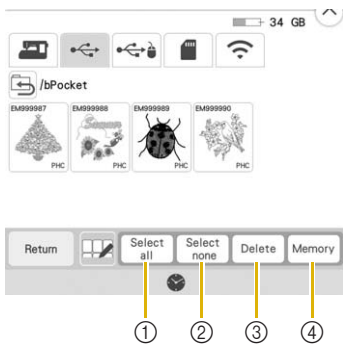

- ① Select all patterns.
- ② Deselect all patterns.
- ③ Delete the selected patterns.
- ④ Save the selected patterns to the machine.

**5** Touch .

# EMBROIDERY APPLICATIONS

## Creating an Appliqué Piece

Appliqué pieces can be created from the built-in patterns and imported patterns. This is convenient for fabrics that cannot be embroidered or when you wish to attach an appliqué to a garment.

### ■ Creating an Appliqué Piece

The following pattern will be used to create an appliqué piece.



#### Note

- Felt or denim fabrics are recommended to make the appliqué piece. Depending on the pattern and fabric used, lighter weight fabrics may cause the stitching to appear smaller.
- For best results, be sure to use stabilizer material for embroidering.
- When making appliqué pieces, do not use the optional border embroidery frame. Depending on the pattern density and fabric used, shrinkage of the stitching may occur.

1 Select the pattern, and edit it if necessary.

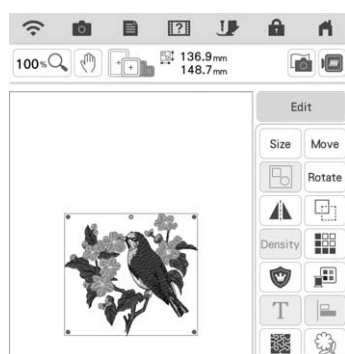

#### Note

- Finish combining and editing the pattern before selecting the appliqué setting. If the pattern is edited after selecting the appliqué setting, the appliqué stitching and pattern may become misaligned.
- Since an outline is added, the pattern for an appliqué piece (when the appliqué setting is selected) will be larger than the original pattern. First, adjust the size and position of the pattern as shown below.

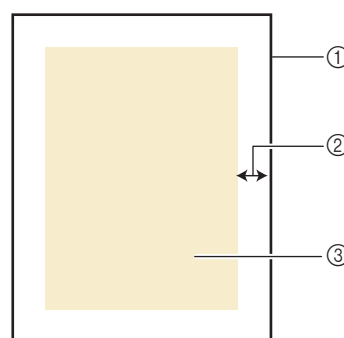

- ① Embroidering area
- ② Approx. 10 mm (3/8 inch)
- ③ Pattern size

2 Touch **Edit**, and then touch .

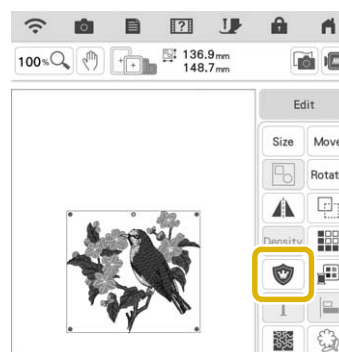

**3** Specify the distance between the pattern and the appliqué outline, and then touch

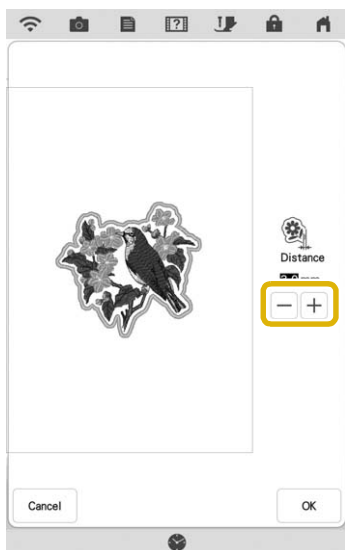

→ The pattern and appliqué outline are grouped.

**4** Touch **Embroidery**.

→ The steps for creating the appliqué piece are added to the embroidering order.

**Memo**

- Three steps are added to the embroidering order: appliqué cutting line, position of pattern placement on the garment, and appliqué stitching.

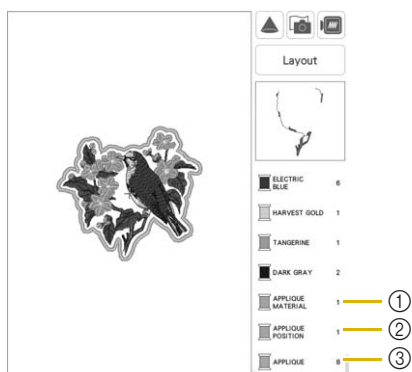

- ① Cutting line for appliqué
- ② Position of pattern placement on garment
- ③ Appliqué stitching

- When setting the [Thread color] to [#123] (thread number) in the settings screen, the following screen is displayed.

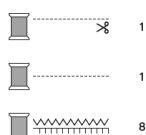

**Note**

- An appliqué piece cannot be created if the pattern is too large or too complicated or a combined pattern is separated. Even if the selected pattern fits within the embroidering area, the entire appliqué pattern may exceed the embroidering area when the outline is added. If an error message appears, select a different pattern or edit it.

- 5** Fuse or stick a piece of stabilizer to the back of the felt or denim fabric to be used as the appliqué piece.
- 6** Hoop the appliqué fabric in the embroidery frame, attach the embroidery frame to the machine, and then start embroidering.
- 7** After the pattern is embroidered, thread the machine with the thread for the cutting line, and then sew the cutting line (APPLIQUE MATERIAL).

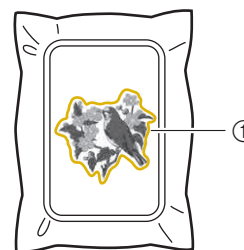

① Cutting line for appliqué

**Memo**

- We recommend using thread for the cutting line that is closest to the color of the fabric.

- 8** Remove the appliqué material from the embroidery frame, and then carefully cut along the stitching. After cutting, carefully remove all of the cutting line thread.

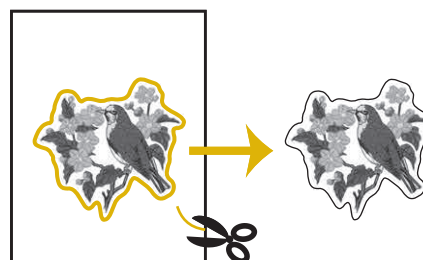



**Note**

- Depending on the pattern density and fabric used, there may be shrinking of the pattern or the appliqué may be misaligned with the placement line. We recommend cutting slightly outside of the cutting line.
- When using patterns that are vertically and horizontally symmetrical, use a chalk pencil to indicate the pattern orientation before cutting it out.
- Carefully cut out the pattern on the outline you just sewed. Do not cut inside the cutting line, otherwise the appliqué fabric will not be caught by the appliqué stitch.

- 9** Use two layers of adhesive water soluble stabilizer material with their sticky sides together, and then hoop them in the embroidery frame.

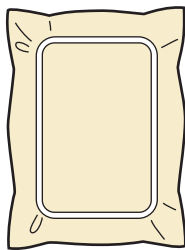

**Note**

- If water soluble stabilizer is used, it is not necessary to remove the stabilizer material after sewing the appliqué outline. To reduce shrinkage of the pattern, we recommend using water soluble stabilizer.
- Put together two layers of water soluble stabilizer, otherwise the stabilizer material may tear during embroidering.

- 10** Thread the machine with the thread for the outline from step 12, and then sew the placement line for the appliqué position (APPLIQUE POSITION).

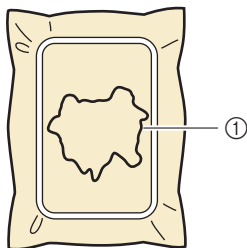

① Pattern placement line

- 11** Lightly apply glue or spray adhesive, and paste the appliqué piece so that it aligns with the placement line.

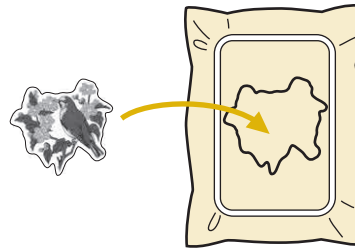

**Note**

- Before pasting the appliqué piece down, make sure the appliqué piece is positioned correctly within the placement line.

- 12** With the machine threaded using the thread for the outline from step 10, embroider the outline (APPLIQUE).

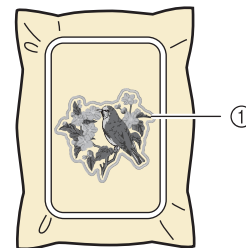

① Outline of appliqué piece

**Memo**

- The outline is sewn using satin stitching.
- Some glue may get onto the embroidery foot, needle, and needle plate at this time. Finish embroidering the appliqué pattern, and then clean off the glue.

- 13** After embroidering is finished, remove the stabilizer material from the embroidery frame.
- 14** Use scissors to cut the excess water soluble stabilizer from outside the appliqué outline.
- 15** Soak the appliqué piece in water to dissolve the water soluble stabilizer.

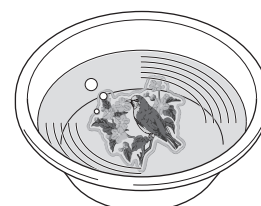



**16** Dry the appliqué piece, and then iron it if necessary.

**Note**

- Do not apply a strong force when ironing, otherwise the stitching may be damaged.

**Using a Frame Pattern for the Outline**

Using a frame pattern, the desired shape can be added as the outline of the appliqué. To select the desired frame, refer to “Selecting Frame Patterns” on page 41.



**1** Select the pattern and edit, if necessary.

**2** Select the desired frame shape and pattern, and add it to the appliqué pattern.

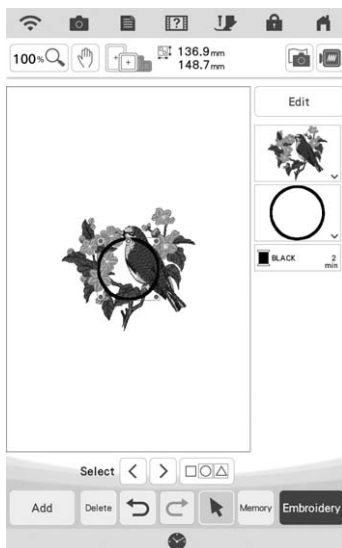

**3** Touch **Edit** to edit the frame pattern to fit the size of the appliqué pattern.

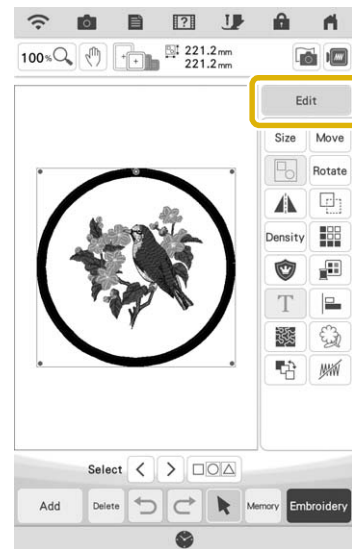

**4** Touch .

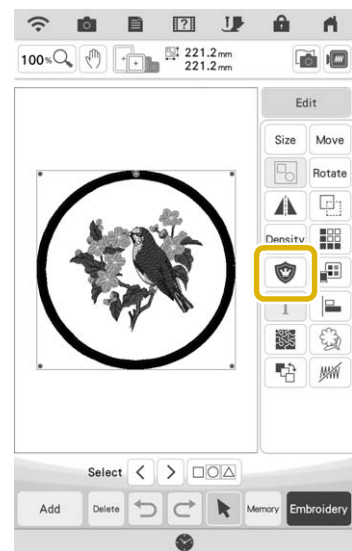

**5** Specify the distance between the frame pattern and the appliqué outline, and then touch **OK**.

6 Touch  to ungroup the patterns.

7 Use   to select the frame pattern, and then touch  and .



→ The frame pattern is deleted.

8 Touch .



9 Continue with step 5 of “Creating an Appliqué Piece” on page 104 to complete the appliqué piece.

## Using Appliqués

### Note

- Refer to “Embroidery Design Guide” to review the recommended method for built-in appliqué patterns. Some appliqué patterns differ from the procedure described in this manual.

This machine can embroider patterns that contain an appliqué. If selecting an embroidery pattern that contains an appliqué, the steps for appliqué appear in embroidery color order display. The display will change depending on the [Thread color] setting (page 97).

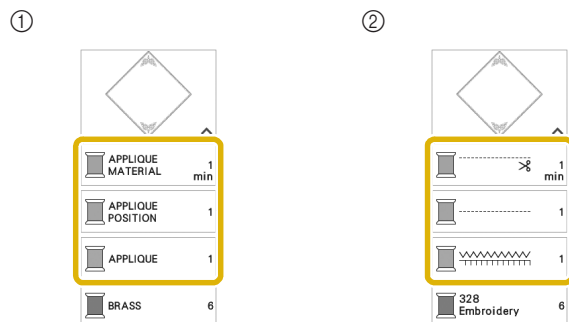

- When [Thread color] is selected.
- When [#123] (thread number) is selected.

Follow the procedure described below.

- Create the appliqué piece.  
↓
- Sew the appliqué position on the base fabric.  
↓
- Affix the appliqué piece to the base fabric.  
↓
- Embroider the remainder of the pattern.

### Required materials

- Fabric for the appliqué piece
- Fabric for the appliqué base
- Stabilizer material
- Craft glue
- Embroidery thread

### Memo

- The specific names and numbers of the thread colors to be used when creating and attaching the appliqué piece will not appear in the embroidery color order display. Use thread colors that coordinate with the appliqué pattern and fabrics.

## 1. Creating the Appliqué Piece

- 1 Select the appliqué pattern, and then continue to the embroidery screen.

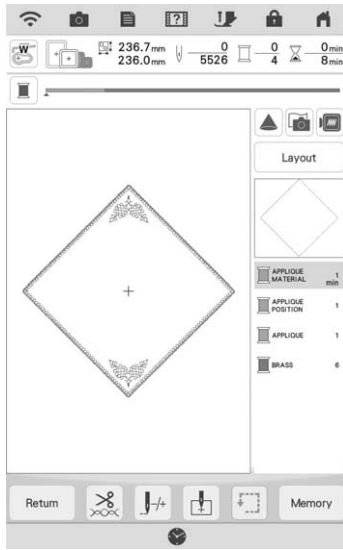

- 2 Attach stabilizer material to the wrong side of the appliqué fabric.

Hoop the fabric in the embroidery frame, and then attach the embroidery frame to the embroidery unit.

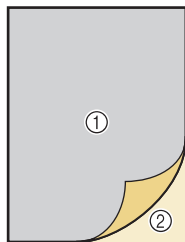

- 1 Appliqué (cotton, felt, etc.)
- 2 Stabilizer

- 3 Thread the machine with the embroidery thread, lower the presser foot lever, and then press the “Start/Stop” button to sew the cutting line of the appliqué piece.

→ The outline of the appliqué piece is sewn, and then the machine stops.

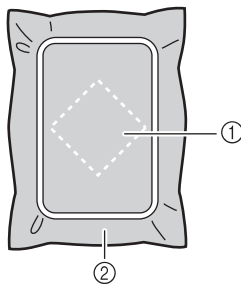

- 1 Cutting line for appliqué piece
- 2 Fabric for appliqué piece

- 4 Remove the fabric for the appliqué piece from the embroidery frame, and then carefully cut along the sewn cutting line.

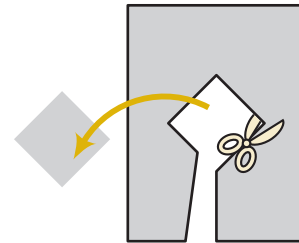

### Note

- If the appliqué piece is cut out along the inside of the cutting line, it may not be correctly attached to the fabric. Therefore, carefully cut out the appliqué piece along the cutting line.
- After cutting out the appliqué piece, carefully remove the thread.

## 2. Sewing the Appliqué Position on the Base Fabric

- 1 Attach stabilizer material to the wrong side of the fabric for the appliqué base.

Hoop the fabric in the embroidery frame, and then attach the embroidery frame to the embroidery unit.

- 2 Thread the machine with the embroidery thread, lower the presser foot lever, and then press the “Start/Stop” button to sew the appliqué position.

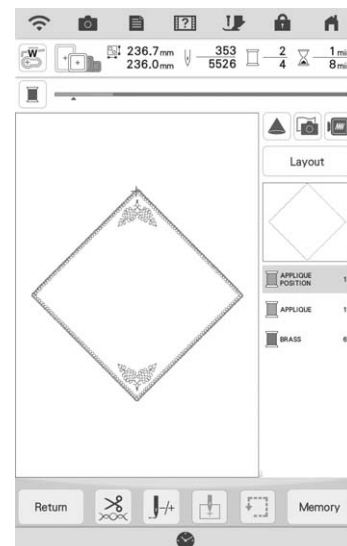

→ The position of the appliqué is sewn, and then the machine stops.

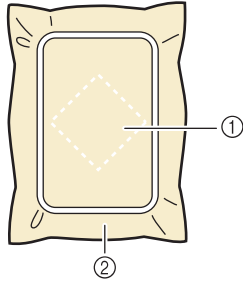

- ① Appliqué position
- ② Base fabric

**3 Remove the embroidery frame from the embroidery unit.**

**Note**

- Do not remove the base fabric from the embroidery frame until all embroidering is finished.

**3. Affixing the Appliqué Piece to the Base Fabric**

**1** Lightly apply craft glue to the back of the appliqué piece, and then attach it to the base fabric within the outline of the position sewn in step 2 of “2. Sewing the Appliqué Position on the Base Fabric”.

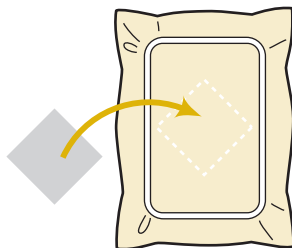

**Note**

- If the appliqué piece is not securely attached to the base fabric, the appliqué piece may lift off the base fabric during embroidering, causing misalignment.
- If the appliqué piece cannot be attached to the base fabric with craft glue, securely baste it in place with basting stitches.
- If thin fabric is used for the appliqué piece, reinforce and secure it in place with an iron-on adhesive sheet. An iron can be used to attach the appliqué piece to the appliqué location.
- Do not remove the fabric from the embroidery frame when attaching the appliqué piece to the base fabric.

**2 After the appliqué piece is attached, attach the embroidery frame to the machine.**

Thread the machine with the embroidery thread, lower the presser foot lever, and then press the “Start/Stop” button to embroider the appliqué.

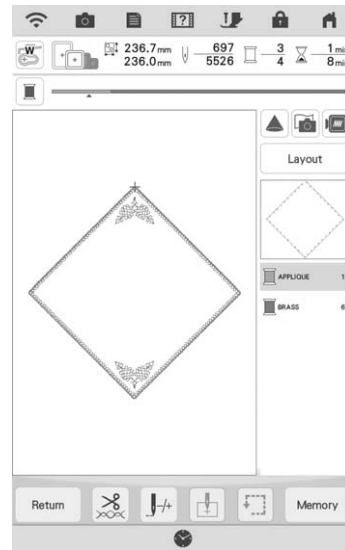

→ The appliqué piece is embroidered to the base fabric, and then the machine stops.

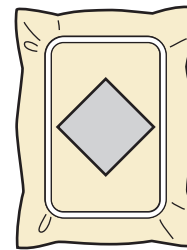

**Memo**

- Depending on the pattern that is selected,
  - APPLIQUE MATERIAL (appliqué piece), ■ APPLIQUE POSITION (appliqué position) and ■ APPLIQUE (appliqué) for all three steps may not appear. If ■ APPLIQUE (appliqué) appears as a color, embroider using thread with a color appropriate for your project.

## 4. Embroidering the Remainder of the Pattern

- 1 Change the embroidery thread according to the embroidery color order display, and then finish embroidering the remainder of the pattern.

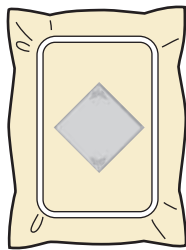
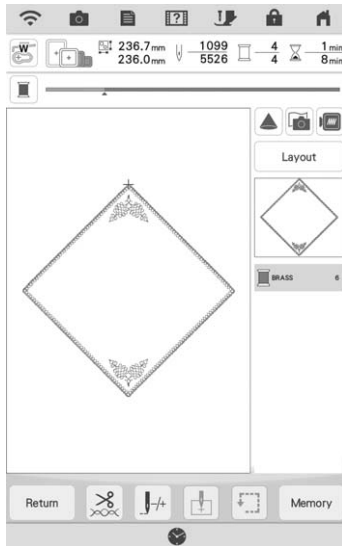

### Memo

- Since glue may become attached to the embroidery foot, needle or needle plate, clean off any glue off after finishing embroidering the appliqué pattern.
- For best results, trim all excess threads each time the thread color is changed.

## Using a Frame Pattern to Make an Appliqué (1)

You can use framed patterns of the same size and shape to create an appliqué. Embroider one pattern with a straight stitch and one pattern with a satin stitch.

- 1 Select a straight stitch frame pattern. Embroider the pattern onto the appliqué material, then cut neatly around the outside of the shape.

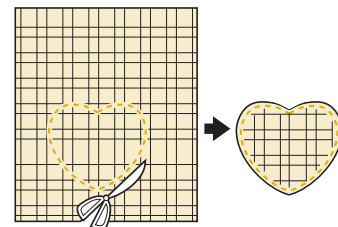
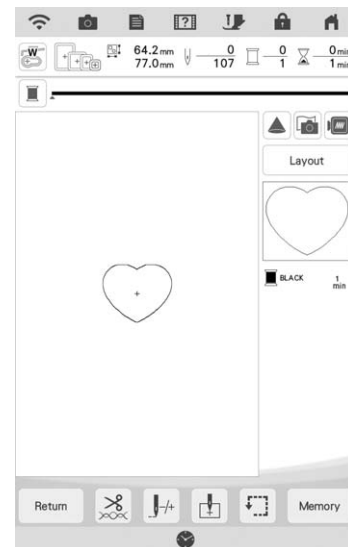

- 2 Embroider the same pattern from step 1 onto the base fabric.

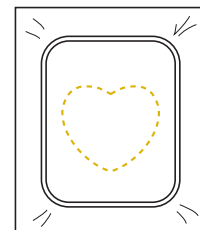

- Apply a thin layer of fabric glue or a temporary spray adhesive to the rear of the appliqué created in step 1. Attach the appliqué to the base fabric matching the shapes.

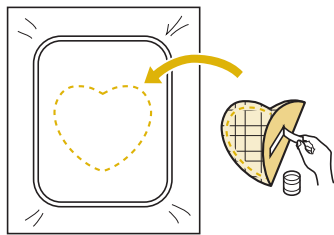

- Select the satin stitch frame pattern of the same shape as the appliqué. Embroider over the appliqué and base fabric from step 3 to create the appliqué.

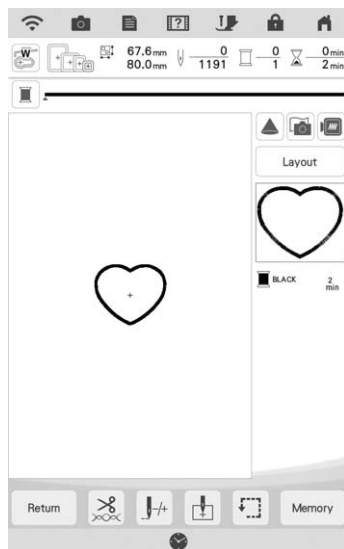

**Note**

- If you change the size or position of the patterns when selecting them, make a note of the size and location.

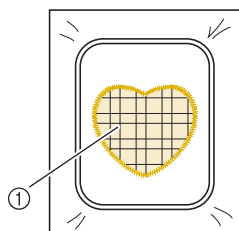

① Appliqué material

## Using a Frame Pattern to Make an Appliqué (2)

This is a second method to make appliqué using embroidery patterns. You do not have to change the fabric in the embroidery frame using this method. Embroider one pattern with a straight stitch and one pattern with a satin stitch.

- Select a straight stitch frame pattern, and embroider the pattern onto the base fabric.

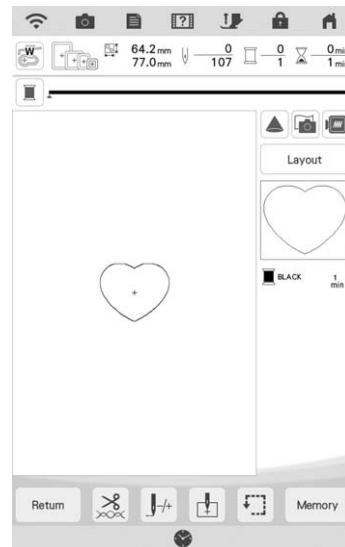

- Place the appliqué fabric over the pattern embroidered in step 1.

\* Be sure that the appliqué fabric completely covers the stitching.

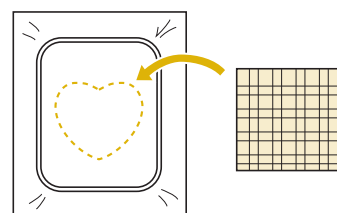

- Embroider the same pattern on the appliqué fabric.

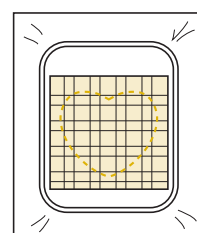

- Remove the embroidery frame from the embroidery unit, and cut around the outside of the stitches.

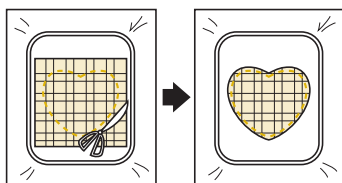

**Note**

- Do not remove the fabric from the embroidery frame to cut it. Also, do not pull strongly on the fabric. Otherwise, the fabric may loosen in the frame.

- Select the satin stitch frame pattern of the same shape as the appliqué.

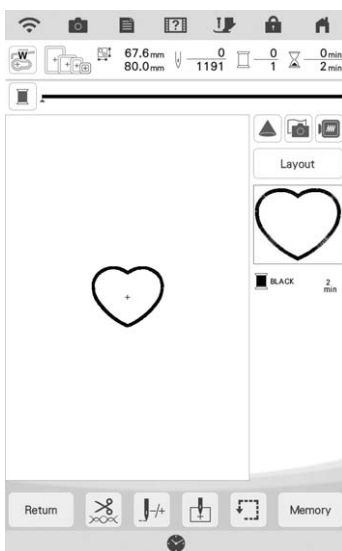

**Note**

- Do not change the size or position of the pattern.
- If you change the size or position of the patterns when selecting them, make a note of the size and location.

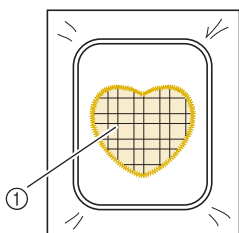

① Appliqué material

- Reattach the embroidery frame to the embroidery unit, and embroider the satin stitch pattern to create an appliqué.

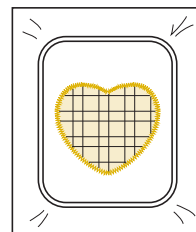

## Embroidering Couching Patterns

Couching patterns can be embroidered using yarn.



### CAUTION

- When using yarn, we recommend selecting yarn of weight 4 (MEDIUM ). Medium yarn is often referred to as worsted weight, 20 knitted stitches per 10 cm, or 9-11 wraps per inch. The diameter of the yarn is approximately 2-3 mm (1/12-1/8 inch). If the yarn is extremely thin or thick, has an unusual shape (flat or furry), or more than 2 yarns, the best finishing results may not be achieved, or injuries or damage may result.

**Note**

- Before embroidering your project, do trial embroidery on a scrap piece of fabric that is the same as that used in your project.

## Preparing for Embroidery Couching

- Turn off the machine. Attach the embroidery unit.
- Install a bobbin wound with embroidery bobbin thread.
- Turn on the machine.
- Touch , and then touch .

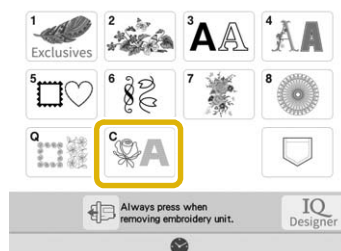



- 5** Select the desired pattern from the desired category.  
And then touch **Set**.

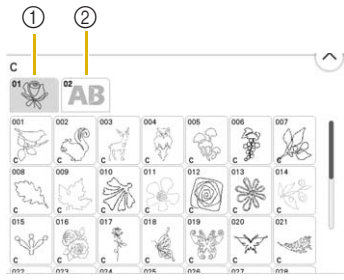

- ① Couching patterns
- ② Fill couching embroidery font

- 6** Touch **⏏** to lock all keys and buttons, and then raise the presser foot lever.

- 7** Attach embroidery couching foot "Y".

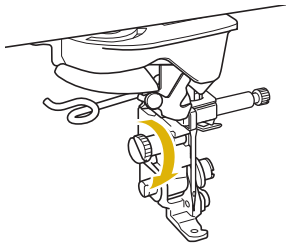

## ⚠ CAUTION

- When using embroidery couching foot "Y", make sure the machine is in embroidery mode. Otherwise, the needle will strike the embroidery couching foot, causing the needle to break and possibly causing injury.

- 8** Rotate the handwheel and check that the needle is in the left half of the hole in embroidery couching foot "Y".

If the needle is not in the left half, use the multi-purpose screwdriver to turn the screw of embroidery couching foot "Y" to adjust the position of the embroidery foot. Turn the screw toward you to move the embroidery foot to the right. Turn the screw toward the back to move the embroidery foot to the left. After making adjustments, rotate the handwheel and check that the needle does not touch the presser foot.

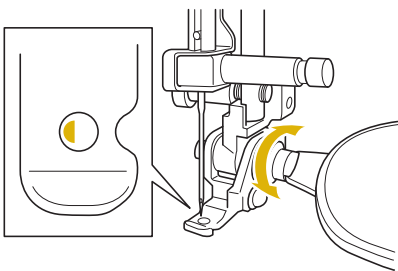

- 9** Attach the spool stand to the machine.

At this time, do not raise the telescopic thread guide shaft.

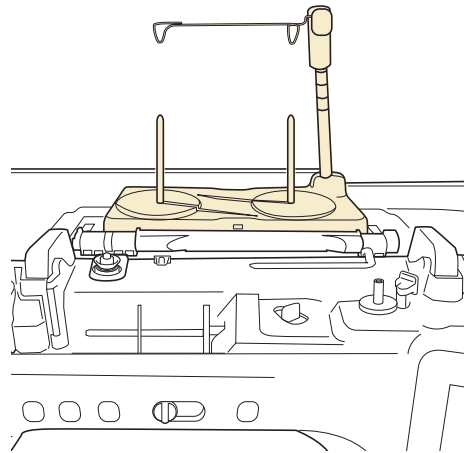

\* Refer to "Using the Spool Stand" on page 24.

- 10** Insert the yarn guide for embroidery couching into the slot on the top left of the machine.

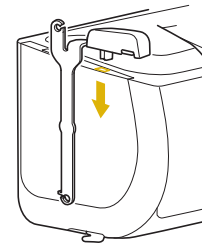

### 💡 Note

- There are two yarn guides: one for sewing couching and one for embroidery couching. Check the shape of the part, and then install the appropriate guide.

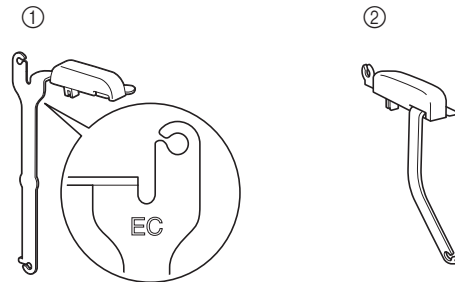

- ① Yarn guide for embroidery couching
- ② Yarn guide for sewing couching



- 11** Pass the yarn through the telescopic thread guide and the yarn guide (1) to (2).

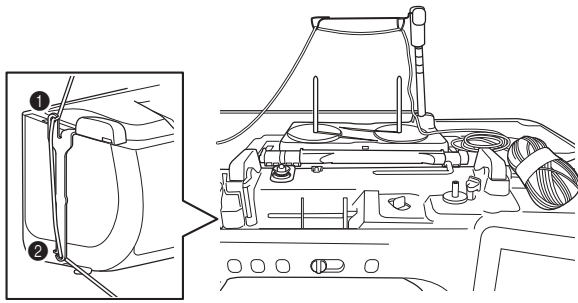

**Note**

- Pull off an appropriate amount of yarn from the ball so that the yarn does not become taut.
- Make sure that the yarn does not become entangled as you work.

- 12** Pass the yarn through the guide on embroidery couching foot “Y”.

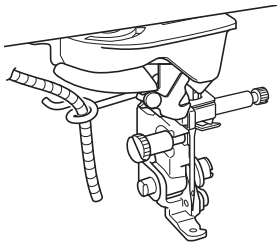

- 13** Thread the yarn through embroidery couching foot “Y”. Pass the yarn through the loop in the yarn threader, and then pass the threader from top to bottom through the hole in embroidery couching foot “Y”. Pull the yarn to the front of the machine.

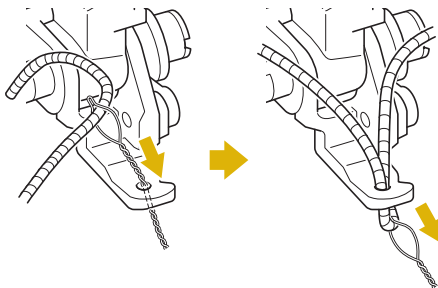

**Memo**

- Place a sheet of paper under the presser foot to smoothly pass the yarn threader through the hole in embroidery couching foot “Y”.

- 14** Touch  to unlock all keys and buttons.

- 15** Thread the machine with the upper thread.

**Note**

- Do not use the spool stand for upper thread. Otherwise thread may tangle with yarn.

**Memo**

- For best results, use an upper thread that is the same color as the yarn.

- 16** Press the "Presser Foot Lifter" button twice to raise the presser foot and then attach the embroidery frame to the embroidery unit.

## ■ Embroidering a Couching Pattern

- 1** Touch .
- 2** Make sure that about 20 cm (8 inches) of yarn is pulled to the front of the machine.
- 3** While holding the yarn in your hand in front of you, press the “Start/Stop” button.

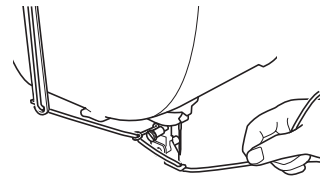

## ⚠ CAUTION

- Pulling the yarn upwards may cause it to catch on the needle, causing it to break. Be careful not to allow the yarn to catch on the needle.

**Note**

- Before embroidering, make sure that there is enough yarn, upper thread and bobbin thread.
- Make sure that the yarn passes smoothly through the guides. Unravel as much yarn from the ball as necessary so that the yarn does not become taut.
- Use yarn that has no knots.

- 4** After embroidering several stitches, release the yarn.

→ When embroidering is finished, the machine will automatically trim the threads and stop.

**Memo**

- When using a high-density yarn, the upper thread tension may be disturbed. If this happens, it is possible to improve it by raising the [Embroidery Foot Height] by about 1 mm on the settings screen.

- 5 Cut the yarn, leaving about 20 cm (8 inches).
- 6 Punch a hole through the fabric with an awl or tapestry needle and then use the yarn threader to pull the excess yarn to the wrong side of the fabric.

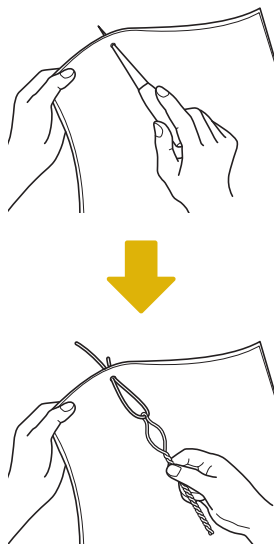

- 7 Tie the end of the yarn so it cannot be pulled out, and then use scissors to cut off any excess yarn.

## Creating Stippling, Echo Quilting, or Decorative Fill Patterns around a Design

Stippling, echo quilting, and decorative fill patterns can be created around the machine's built-in patterns or original embroidery data without using IQ Designer.

### Memo

- If this simple stippling operation is used with batting sandwiched between two layers of fabric, the embroidery pattern and stippling may become misaligned. Stippling can be added in IQ Designer after the pattern is embroidered. For details, refer to "Decorative Stitching Around a Pattern in Embroidery (a Quilting Function)" on page 185.

- 1 Select the pattern that stippling will be added around.

\* To select multiple patterns, refer to "Selecting Multiple Patterns at the Same Time" on page 83.

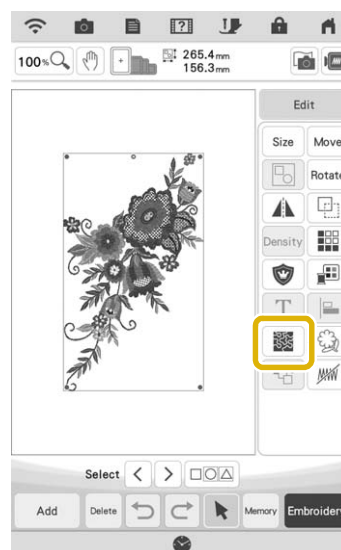

- 2 Touch  in the embroidery edit screen.

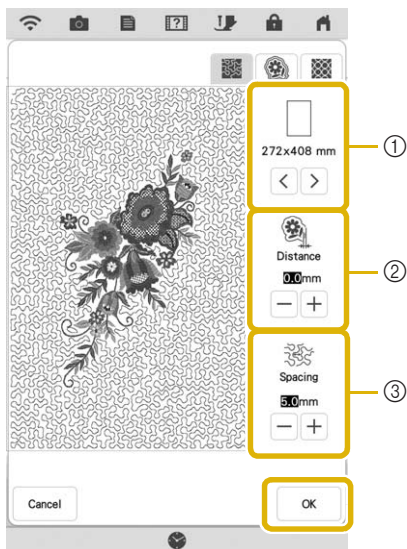

→ Stippling is automatically applied around the selected pattern.

- 3 After specifying the stitch settings for the stippling, touch .



- ① The stippling is added within the area of the selected frame size. If the pattern is larger than the selected frame size, the area indicating the frame size will appear in gray, and stippling will not be added.
- ② Specify the distance from the outline of the pattern to the stippling.
- ③ Specify the spacing for the stippling.
- \* Touch  in the stippling settings screen to create an echo quilting pattern.
- \* Touch  in the stippling settings screen to create a decorative fill pattern.

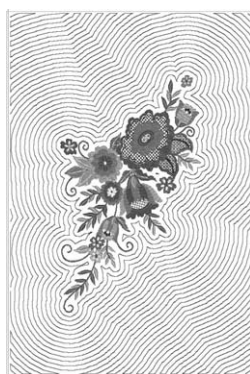

①



②

- ① Echo quilting pattern
- ② Decorative fill pattern

## Embroidering a Quilting Pattern Across the Entire Fabric (Edge-to-Edge Quilt Function)

Connect quilting patterns to embroider from edge to edge of a specified area. By rehooping a large piece of fabric, you can continue embroidering the quilting pattern across the entire fabric.

### Creating Edge-to-Edge Quilt Data

- 1 Determine the area of the fabric to be embroidered, and then draw a line around it with a chalk pencil. Measure the width and height.

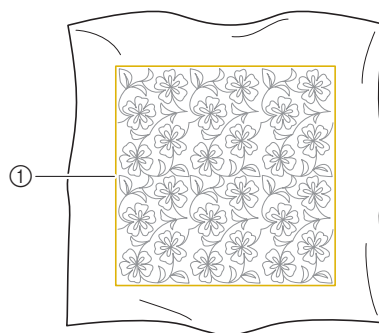

① Embroidering area

#### Note

- Make sure that the chalk pencil line is within the embroidering area when the fabric is hooped.

- 2 Touch , and then touch .

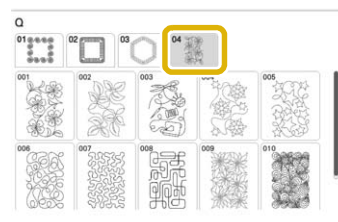

**3** Select the pattern that you want to embroider, and then touch **Set**.

**4** Specify ① to ④, and then touch **Next**.

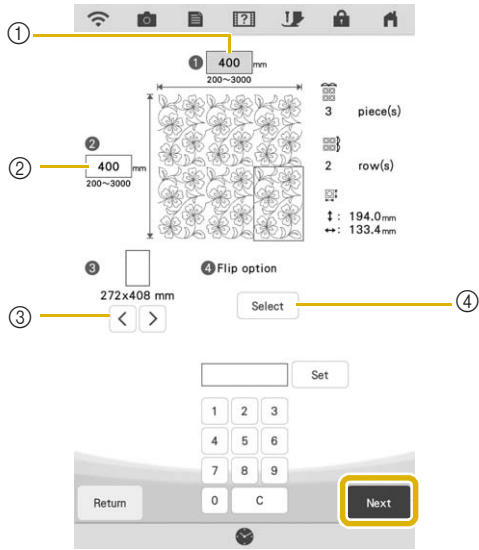

- ① Width
- ② Height

\* After entering a value, touch **Set** to apply the value. To clear the entered value, touch **C**.

- ③ Touch **<** or **>** to select the embroidery frame size.
- ④ Touch **Select** to flip every other pattern. Select the desired flip arrangement (no flipping, left/right flipping, up/down flipping, left/right and up/down flipping) from the flip keys, and then touch **OK**.

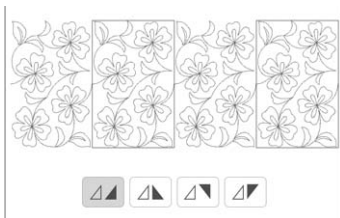

**5** Check the pattern, and then touch **Memory** to save it.

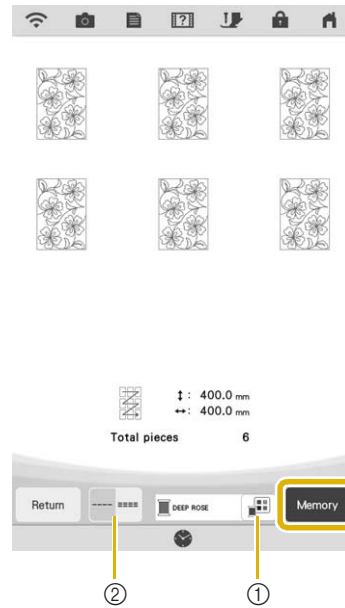

- ① The thread color can be changed.
- ② Select single stitching or triple stitching.

**6** After the following message appears, touch **OK**.

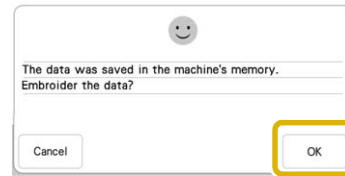

→ A screen appears so that a pattern from the machine's memory can be selected.

## ■ Embroidering the Edge-to-Edge Quilt Pattern

**1** In the screen for selecting a pattern from the machine's memory, select the saved data.



- 2** For this example, since we will embroider the edge-to-edge quilt pattern according to the on-screen instructions, select the thumbnail for the entire edge-to-edge quilt pattern. And then touch **Set**.

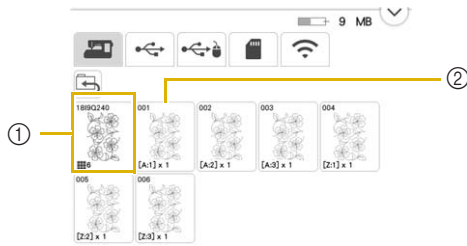

- ① Touch this key to embroider the edge-to-edge quilt pattern according to the on-screen instructions. The number in the lower-left corner indicates the total number of segments for the edge-to-edge quilt pattern.
- ② To embroider by visually aligning the pattern sections, touch each pattern section to be embroidered. You can check where and how many times the part will be embroidered with the codes written on each key. “A” refers to rows other than the last one, “Z” refers to the last row, and the numbers indicate the order in which the patterns are to be connected. Example: When connecting patterns in four rows and four columns

A:1	A:2	A:3	A:4
A:1	A:2	A:3	A:4
A:1	A:2	A:3	A:4
Z:1	Z:2	Z:3	Z:4

- 3** Hoop the quilt in the embroidery frame so that the marked upper-left corner of the edge-to-edge quilt pattern is in the embroidering area, and then attach the embroidery frame.



- 4** Use the move pattern keys to align the upper-left corner of the chalk reference lines previously drawn on the quilt with the upper-left corner of the part projected by the projector. Then, touch **OK**.

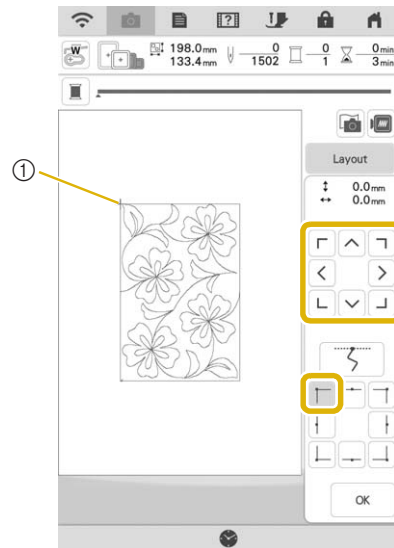

- ① Upper-left corner





- 5** Rotate the pattern to align the upper-right corner with the chalk reference line.

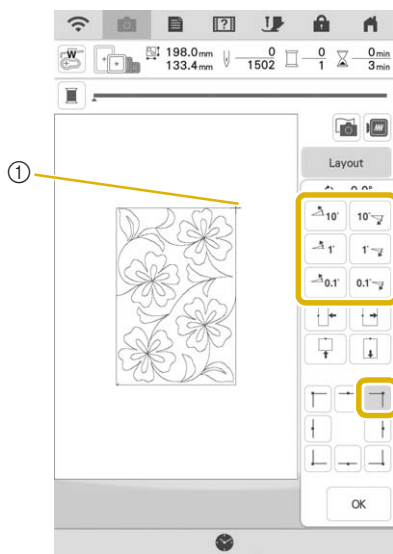

① Upper-right corner

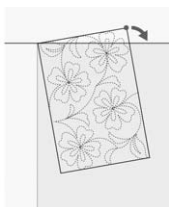

- 6** Touch  to display the embroidery screen.

**Memo**

- To readjust the position or angle of the pattern, touch , and then touch  or .

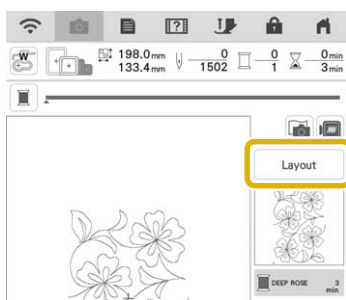

- 7** Press the "Start/Stop" button to embroider the first part.

- 8** When embroidering is finished and the following message appears, touch .

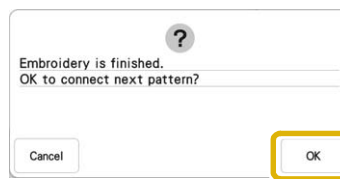

→ The next part to be embroidered appears.

- 9** Position each part and embroider it according to the on-screen instructions. You will be prompted to align the starting point and to rehoop the quilt when necessary.

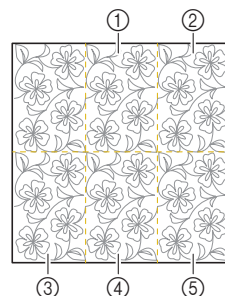

- ① Second column of first row (  )



Use the move pattern keys to align the start point with the end point of the previous pattern.

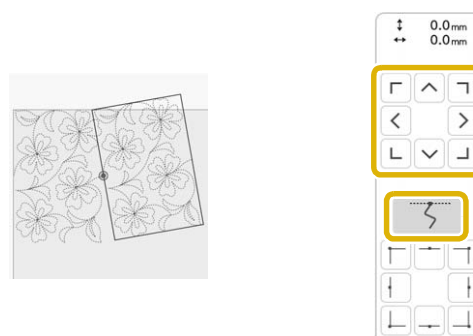

**Note**

- For precise positioning of the start point, rotate the handwheel toward you to check the exact needle drop point. After checking the needle position, be sure to use the needle up/down key to return the needle to its highest position.

Rotate the pattern to align the upper-right corner with the chalk reference line.

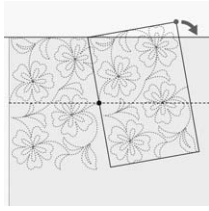

② Rightmost column of first row (  )

Use the move pattern keys to align the start point with the end point of the previous pattern.

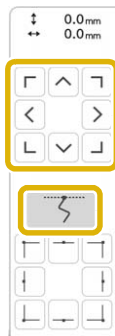
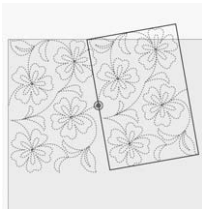

To align the upper-right corner with the chalk reference lines, adjust the angle and width of the pattern.

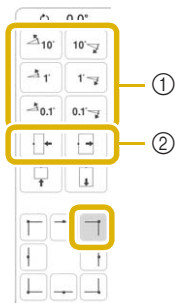
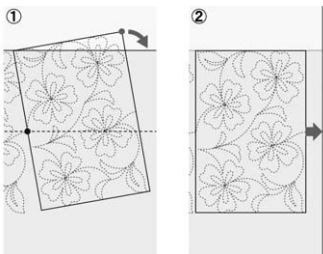

- ① Touch to change the angle of the pattern.
- ② Touch to change the width of the pattern.

③ Leftmost column of second row (last row) (  )



Use the move pattern keys to align the upper-left corner with the thread mark of the embroidered pattern above.

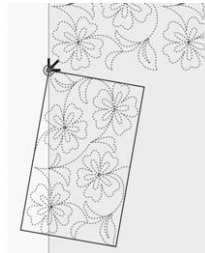

To align the upper-right corner with the thread mark of the embroidered pattern above, adjust the angle and width of the pattern.

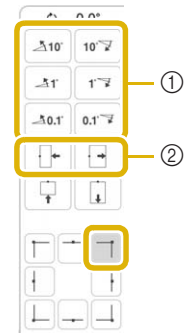
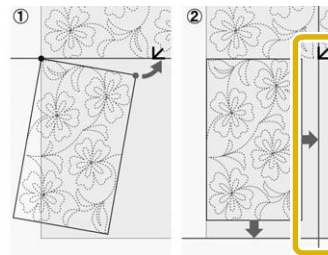

- ① Touch to change the angle of the pattern.
- ② Touch to change the width of the pattern.

Touch , and then adjust the length to align the pattern with the chalk reference line.

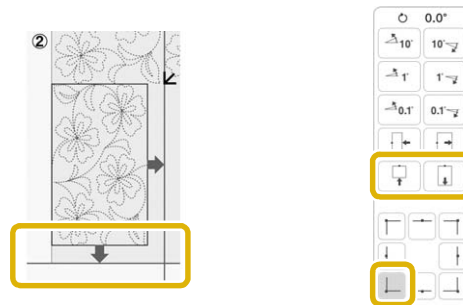



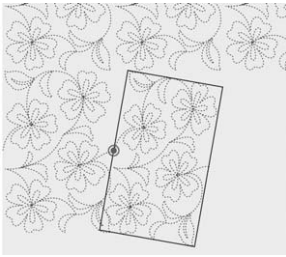

④ **Second column of the second row (last row)** (  )

Use the move pattern keys to align the start point with the end point of the previous pattern.

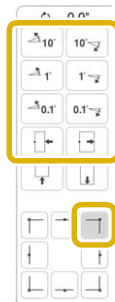
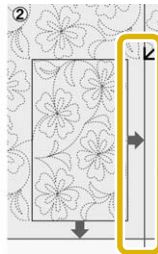
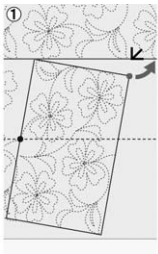

To align the upper-right corner with the thread mark of the embroidered pattern above, adjust the angle and width of the pattern.



Touch , and then adjust the length to align the pattern with the chalk reference line.

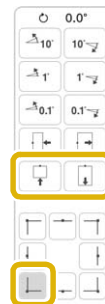
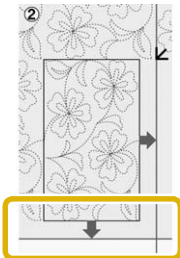

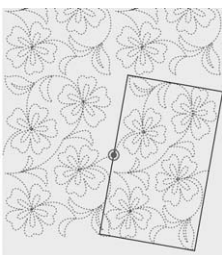

⑤ **Rightmost column of second row (last row)** (  )

Use the move pattern keys to align the start point with the end point of the previous pattern.

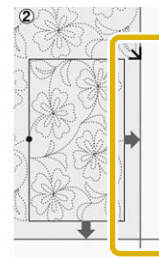
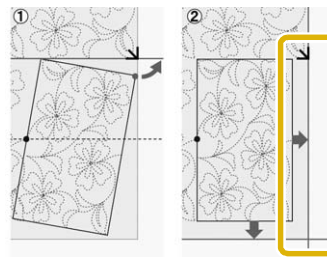

To align the upper-right corner with the thread mark of the embroidered pattern above, adjust the angle and width of the pattern.



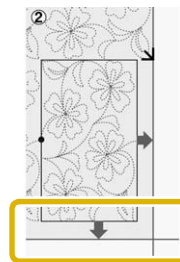

Touch , and then adjust the length to align the pattern with the chalk reference line.



**10** Remove the thread marks.

**Memo**

- If you need to restitch a segment or skip a segment, you can touch  in the embroidery screen to continue to the next pattern or return to the previous pattern. Select the desired pattern in the embroidering order, and then touch .

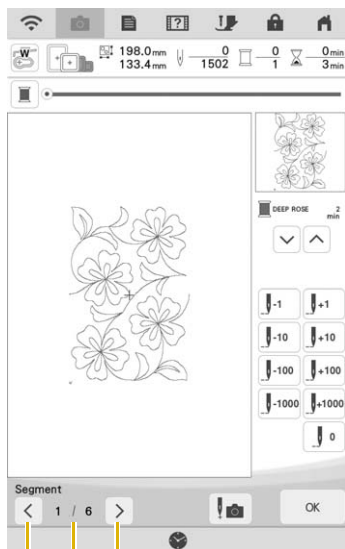

- ①
- ②
- ③

- ① Return to the previous pattern.
- ② Embroidering order of current pattern/Total number of segments
- ③ Continue to the next pattern.

## Embroidering Quilting Border Patterns (Auto Split Quilt Sash)

Quilting border patterns up to 760 mm x 500 mm (approx. 29-7/8 inches x 19-5/8 inches) can be split into four sections to be stitched in the 408 mm x 272 mm (16 inches x 10-5/8 inches) embroidery frame. The built-in camera will assist with placement.

It is recommended to measure the size of quilting border you want to embroider in the beginning.

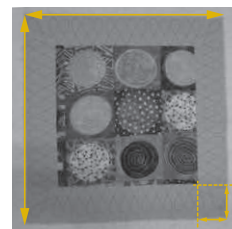

- 1** Touch .



- 2** Select one of the rectangular quilting border categories. For this example, select single-color rectangular quilting border patterns.

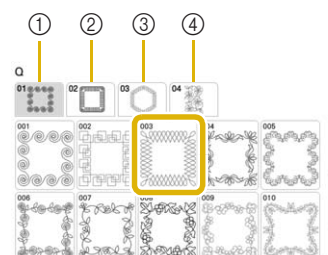

- ① Single-color rectangular quilting border patterns
- ② Two-color rectangular quilting border patterns
- ③ Hexagonal quilt border patterns
- ④ Edge-to-Edge quilt patterns

**Memo**

- The hexagonal quilt borders patterns and edge-to-edge quilt patterns are not available for this function.

**3** Select the quilt border pattern, and then touch **Set**.

**4** Select how to divide the pattern. For this example, select “Auto split quilt sash”.

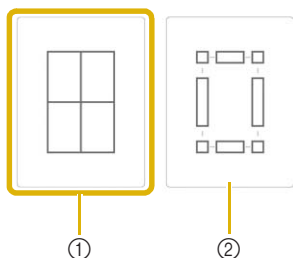

- ① Auto split quilt sash
  - ② Semi-Auto split quilt sash
- For details, refer to “Embroidering Quilting Border Patterns (Semi-Auto Split Quilt Sash)” on page 126

**Note**

- The size of item that can be created differs depending on the type of split that was selected. Check the layout of “Auto split quilt sash”, and then select “Semi-Auto split quilt sash” if the layout did not appear as desired.

**5** Specify the size of embroidery frame to be used. Enter values for the width and height of the sash and quilting border, and then touch **Set**. After entering all three values, touch **Next**.

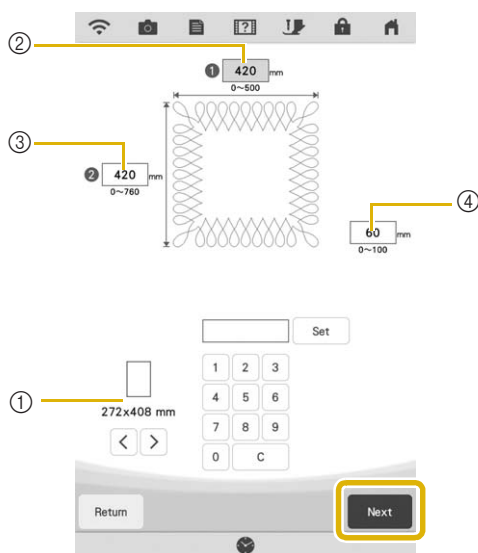

- ① Embroidery frame size
  - ② Width
  - ③ Height
  - ④ Quilting border width
- \* To clear the value, touch **C**.

→ The pattern appears with the specified settings applied.

**6** Check the split pattern, and then touch **Memory**.

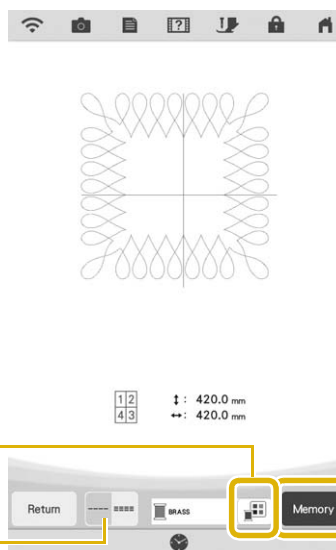

- ① You can change the thread color.
  - ② Select single stitching or triple stitching.
- The data for the split embroidery pattern is saved on the machine.

**Memo**

- The data for the split embroidery pattern cannot be saved on external media such as USB media.

**7** To embroider the pattern, touch **OK**.

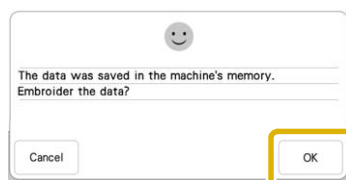

**8** Select the embroidering method, and then touch **Set**.

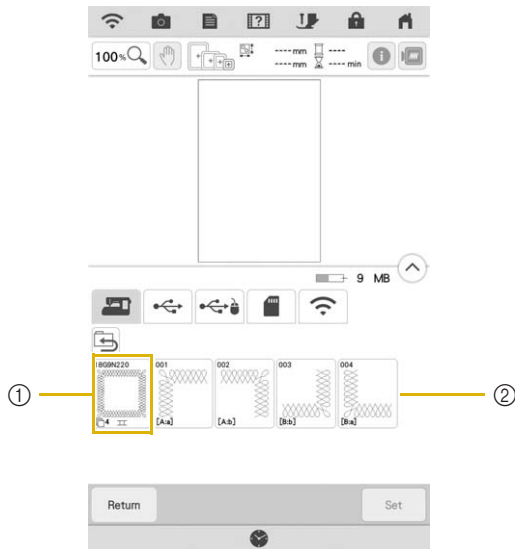

- ① To embroider using the built-in camera for aligning the embroidering position, touch the key showing the entire pattern.
  - ② To embroider by visually aligning the pattern sections, touch the pattern section to be embroidered.
- \* This manual shows method ①. For method ②, refer to “Connecting the Pattern Sections Manually” on page 138.

**9** Touch **Embroidery**.

**10** Attach the embroidery frame along with the first section being embroidered, and scan the frame. For scanning the background, refer to “Display the Fabric while Aligning the Embroidering Position” on page 86.

**11** Move and rotate the pattern to align with the background.

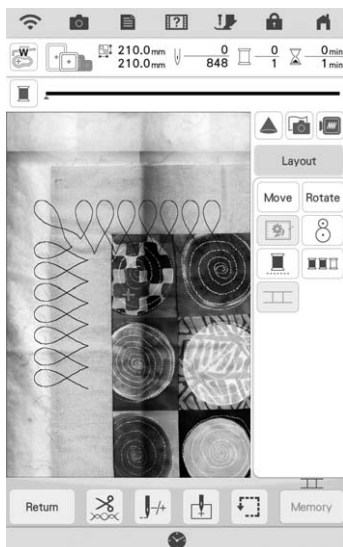

- For moving the pattern, refer to “Moving the Pattern” on page 59.
- For rotating the pattern, refer to “Rotating the Pattern” on page 59.

**12** Embroider the first section.

**13** After embroidering the first section, the following message appears. Touch **OK**.

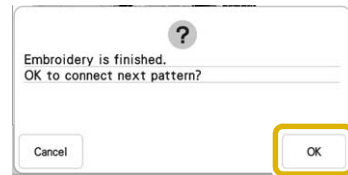

**14** Touch **II**.



**15** Touch **OK**.

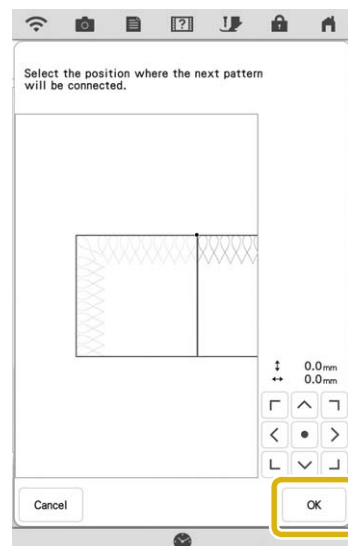

**16** Embroider the remaining sections following the step 13 on page 142 through step 19 on page 144 of “Connecting Three Patterns”.

## Embroidering Quilting Border Patterns (Semi-Auto Split Quilt Sash)

By rehooping the fabric to embroider connecting patterns, a quilting border of up to 3 m × 3 m (approx. 118 inches × 118 inches) can be created. The pattern is positioned manually.

### ■ Creating Quilting Border Data

- 1 With a chalk pencil, mark the quilt top with the inner outline of the quilting border to be embroidered. Measure the size of the quilting border.

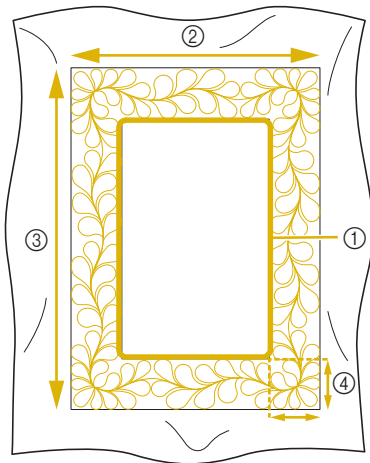

- 1 Inner outline (used for positioning)
- 2 Width (includes the width of borders)
- 3 Height (includes the height of borders)
- 4 Width of quilting border

#### Memo

- Be sure to cut the quilt layers (quilt top, batting, and quilt backing) with an excess of about 10 cm (4 inches) so that the quilt will extend to the edges of the embroidery frame.

- 2 Touch .

- 3 Select a sub-category. For this example, select two-color rectangular quilting border patterns.

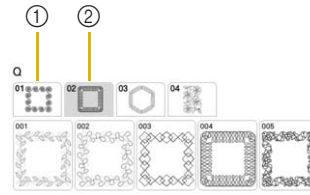

- 1 Single-color rectangular quilting border patterns
- 2 Two-color rectangular quilting border patterns

- 4 Select the pattern that you want to embroider, and then touch .

- 5 Select how to divide the pattern. For this example, select "Semi-Auto split quilt sash".

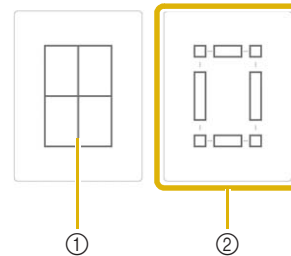

- 1 Auto split quilt sash  
For details, refer to "Embroidering Quilting Border Patterns (Auto Split Quilt Sash)" on page 123
- 2 Semi-Auto split quilt sash

- 6** Specify the size of embroidery frame to be used and the size of the quilting border, and then touch **Next**.

**Memo**

- Mark the upper-right corner of the quilt border with a chalk pencil. On the machine's screen, enter the horizontal and vertical measurements to match the orientation of the quilt with the marked corner positioned in the upper right.

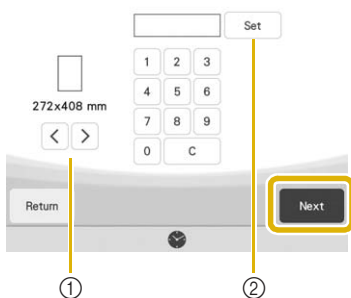
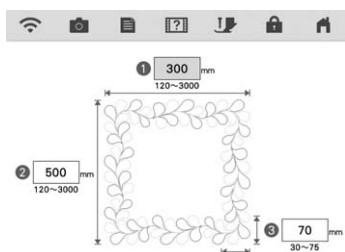

- Touch **<** or **>** to select the embroidery frame size.
- Specify the width **①**, height **②** and quilting border width **③**, and then touch **Set**.

- 7** Check the pattern, and then touch **Memory** to save it.

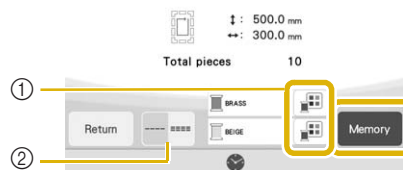
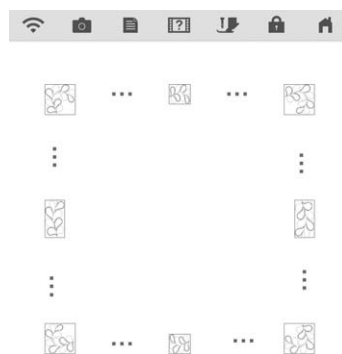

- The thread colors can be changed.
- Select single stitching or triple stitching.

**Memo**

- The edges of the pattern may be shortened when they are displayed.

- 8** After the following message appears, touch **OK**.

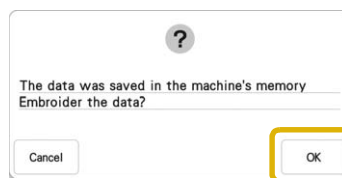

→ A screen appears so that a pattern from the machine's memory can be selected.

**Embroidering a Quilting Border**

- 1** In the screen for selecting a pattern from the machine's memory, select the saved data.



→ A thumbnail of the entire quilting border and thumbnails of the parts in each section appear.



**2** For this example, since we will embroider the quilting border according to the on-screen instructions, select the thumbnail for the entire quilting border. And then touch **Set**.

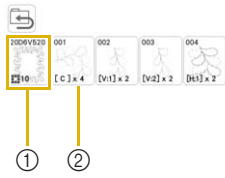

- ① Touch this key to embroider the quilting border according to the on-screen instructions. The number in the lower-left corner indicates the total number of segments for the quilt border.
- ② To embroider by visually aligning the pattern sections, touch each pattern section to be embroidered. You can check where and how many times the part will be embroidered with the codes written on each key.

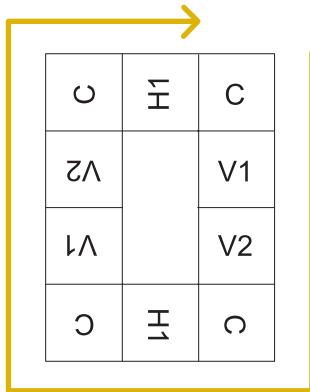

C: Corner  
 V1: The first part of the vertical side  
 V2: The second part of the vertical side  
 H1: The first part of the horizontal side

**3** Hoop the quilt in the embroidery frame so that the the marked upper-right corner of the quilting border is in the embroidering area, and then attach the embroidery frame.

**4** Align the position for the part in the upper-right corner.

With  selected, move the needle to the inner corner. Use the move pattern keys to align the inside upper-right corner of the reference lines previously drawn on the quilt with the inner corner of the part projected by the projector.

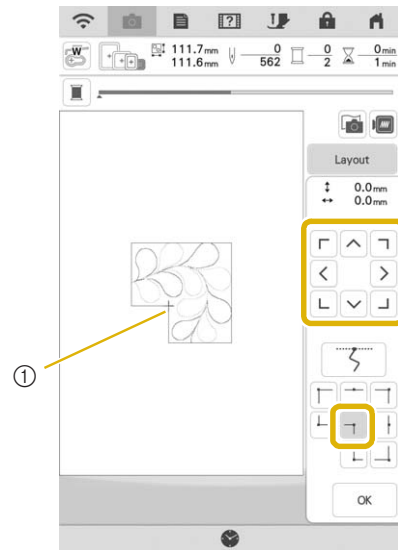

① Inner corner

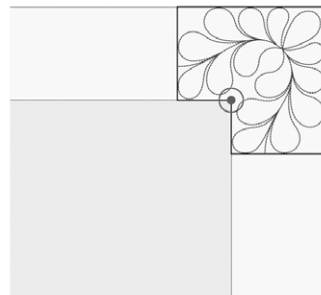

**Memo**

- The needle drop point projected by the projector can be corrected on the settings screen. For the procedure, refer to "Needle Calibration Using the Built-in Camera" in the machine's Instruction and Reference Guide (Sewing).

**Memo**

- If necessary, rotate the pattern so that it is aligned between the chalk reference lines.

**5** Touch  to display the embroidery screen.

**6** Press the "Start/Stop" button to embroider the first part.



**7** When embroidering is finished and the following message appears, touch .

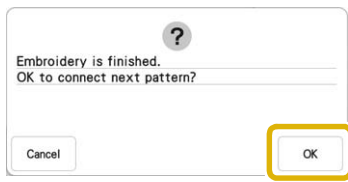

→ The next part to be embroidered appears.

**8** Position each part and embroider it according to the on-screen instructions.

You will be prompted to align the starting point, rotate the design, and to rehoop the quilt when necessary.

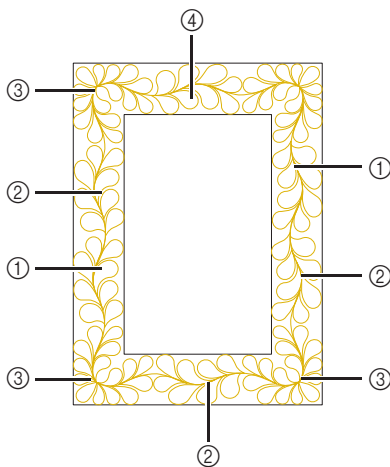

**①** When embroidering the edge part

Use the move pattern keys to align the start point projected by the projector with the end point of the previous pattern, and then touch .

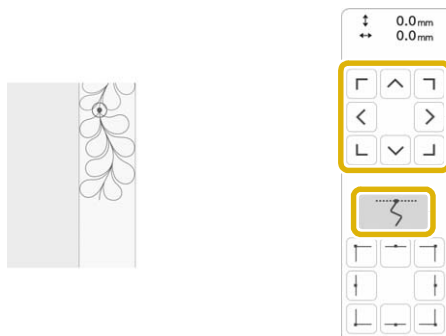

**Note**

- For precise positioning of the start point, rotate the handwheel toward you to check the needle drop point. After checking the needle position, be sure to use the needle up/down key to return the needle to its highest position.

**Memo**

- If the next pattern can be embroidered without rehooping the project, the on-screen instructions to align the start point of the pattern will not be displayed as the pattern will automatically be aligned with the start point.

Rotate the pattern to align the corner with the reference line, and then touch .



**②** When embroidering the edge part immediately before a corner

Use the move pattern keys to align the start point projected by the projector with the end point of the previous pattern, and then touch .

Then, align the lower-left point (inner corner of the next pattern to be embroidered) with the lower-left corner of the reference lines. If the pattern is not angled correctly, rotate it. If the length of the pattern does not match, enlarge or reduce the pattern so that the lower-left point is at the lower-left corner of the reference lines.

After making adjustments, touch .

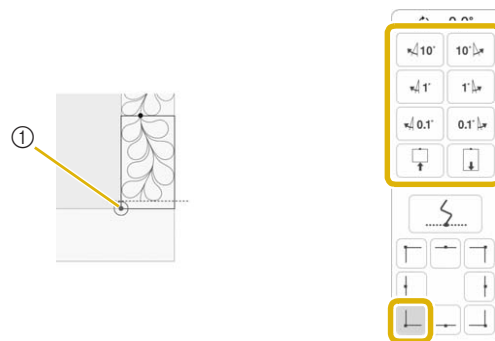

① Inner corner of next pattern to be embroidered

③ When embroidering the corner part

Rotate the quilt 90 degrees counterclockwise, rehoop it, and then attach the embroidery frame to the machine. Use the move pattern keys to align the start point projected by the projector with the end point of the previous pattern, and then touch **OK**.

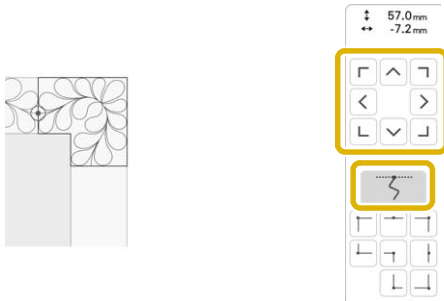

Then, align the inner corner of the pattern with the corner of the reference lines.



**Memo**

- The width of the corner segment can be adjusted to best fit the inner corner. However, make adjustments so that the shape is not deformed.

④ When embroidering the last edge part

Use the move pattern keys to align the start point projected by the projector with the end point of the previous pattern, and then touch **OK**.

Then, align the end point of the part with the start point of the first part. If the pattern is not angled correctly, rotate it. If the length of the pattern does not match, enlarge or reduce the pattern.

After making adjustments, touch **OK**.

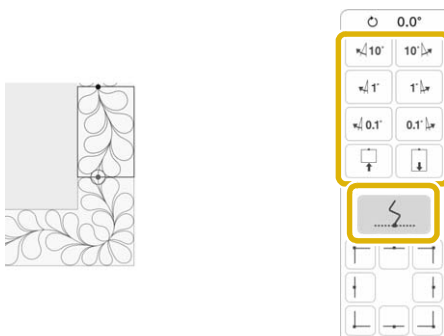

**Memo**

- If you need to restitch a segment or skip a segment, you can touch **J+/** in the embroidery screen to continue to the next pattern or return to the previous pattern. Select the desired pattern in the embroidering order, and then touch **OK**.

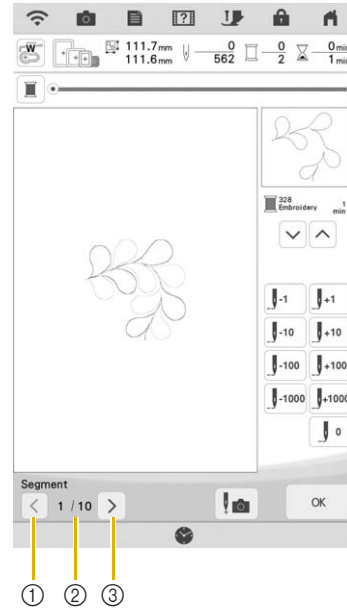

- ① Return to the previous pattern.
- ② Embroidering order of current pattern/Total number of segments
- ③ Continue to the next pattern.

## Hexagonal Quilting Borders

### ■ Creating Quilting Border Data

- 1 With a chalk pencil, mark the quilt top with the inner outline of the quilting border to be embroidered.  
Measure the longest diagonal of the inner outline and the width of the quilting border.

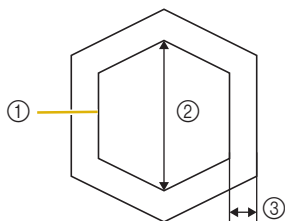

- ① Inner outline (used for positioning)
- ② Longest diagonal
- ③ Width of quilting border

#### Memo

- Be sure to cut the quilt layers (quilt top, batting, and quilt backing) with an excess of about 10 cm (4 inches) so that the quilt will extend to the edges of the embroidery frame.
- Hexagonal patterns can be embroidered with a diagonal width of maximum 2600 mm (approx. 102 inches) and a quilting border width of maximum 100 mm (approx. 4 inches).

- 2 Touch .

- 3 Touch .

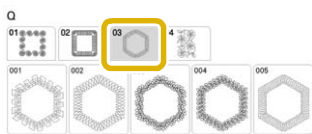

- 4 Select the pattern that you want to embroider, and then touch .

- 5 Specify the size of embroidery frame to be used and the measurements for the quilting border, and then touch .

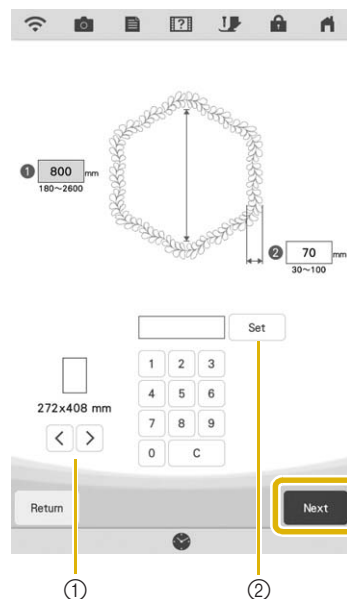

- ① Touch or to select the embroidery frame size.
- ② Specify the length of the longest diagonal for the inner outline (①) and the quilting border width (②), and then touch .

- 6** Check the pattern, and then touch **Memory** to save it.

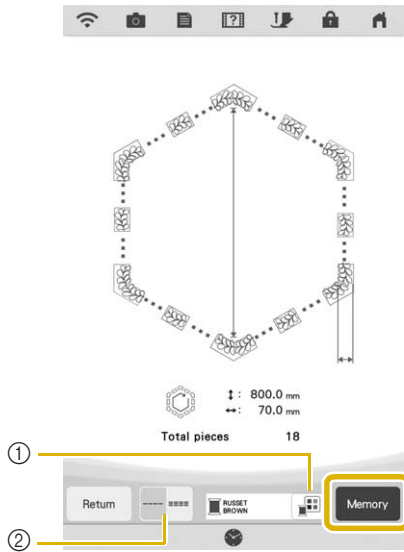

- ① The thread colors can be changed.
- ② Select single stitching or triple stitching.

**Memo**

- The edges of the pattern may be shortened when they are displayed.

- 7** After the following message appears, touch **OK**.

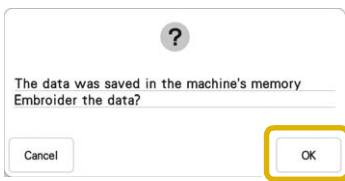

→ A screen appears so that a pattern from the machine's memory can be selected.

**Embroidering a Quilting Border**

- 1** In the screen for selecting a pattern from the machine's memory, select the saved data.



→ A thumbnail of the entire quilting border and thumbnails of the parts in each section appear.

- 2** For this example, since we will embroider the quilting border according to the on-screen instructions, select the thumbnail for the entire quilting border. And then touch **Set**.

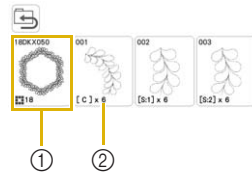

- ① Touch this key to embroider the quilting border according to the on-screen instructions. The number in the lower-left corner indicates the total number of segments for the quilt border.
- ② To embroider by visually aligning the pattern sections, touch each pattern section to be embroidered. You can check where and how many times the part will be embroidered with the codes written on each key.

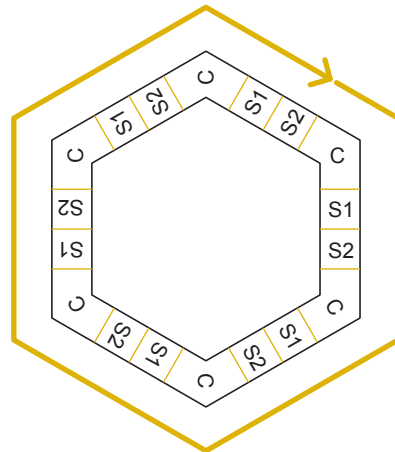

C: Corner  
S: Side

- 3** Hoop the quilt in the embroidery frame so that the one of the corners of the quilting border is in the embroidering area, and then attach the embroidery frame.

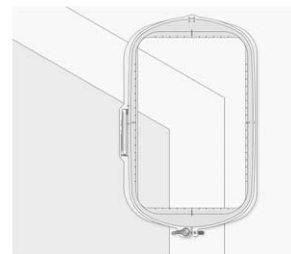

**4** Align the position for the part in the corner.

Use the move pattern keys to align the inside corner of the reference lines previously drawn on the quilt with the inner corner of the part projected by the projector.

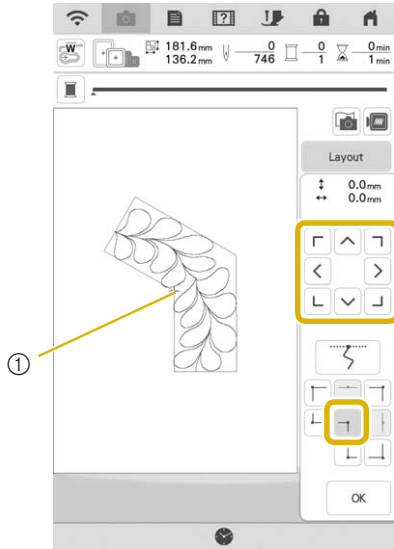

① Inner corner

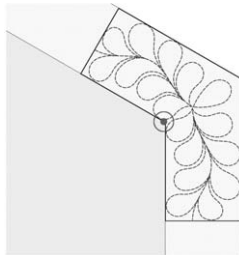

**Memo**

- The needle drop point projected by the projector can be corrected on the settings screen. For the procedure, refer to "Needle Calibration Using the Built-in Camera" in the machine's Instruction and Reference Guide (Sewing).
- If necessary, rotate the pattern so that it is aligned between the chalk reference lines.

**5** Touch  to display the embroidery screen.

**6** Press the "Start/Stop" button to embroider the first part.

**7** When embroidering is finished and the following message appears, touch .

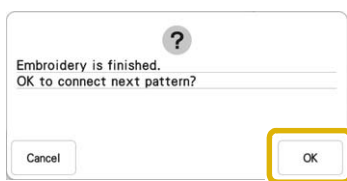

→ The next part to be embroidered appears.

**8** Position each part and embroider it according to the on-screen instructions.

You will be prompted to align the starting point, rotate the design, and to rehoop the quilt when necessary.

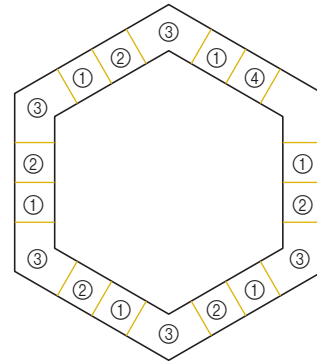

**①** When embroidering the edge part

Use the move pattern keys to align the start point projected by the projector with the end point of the previous pattern, and then touch .

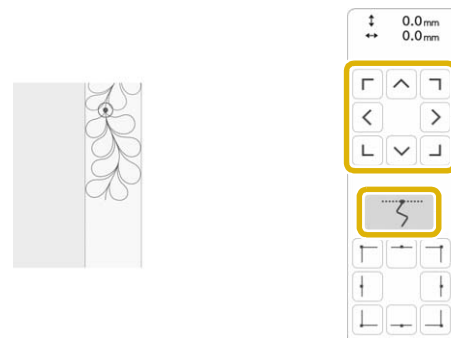

**Note**

- For precise positioning of the start point, rotate the handwheel toward you to check the needle drop point. After checking the needle position, be sure to use the needle up/down key to return the needle to its highest position.

**Memo**

- If the next pattern can be embroidered without rehooping the project, the on-screen instructions to align the start point of the pattern will not be displayed as the pattern will automatically be aligned with the start point.

Rotate the pattern to align the corner of the projected segment with the reference line on the quilt, and then touch .

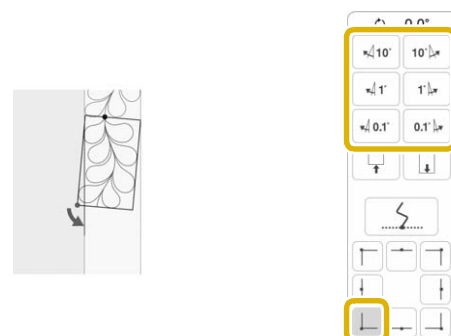

② **When embroidering the edge part immediately before a corner**

Use the move pattern keys to align the start point projected by the projector with the end point of the previous pattern, and then touch .

Then, align the lower-left point (inner corner of the next pattern to be embroidered) with the lower-left corner of the reference lines. If the pattern is not angled correctly, rotate it. If the length of the pattern does not match, enlarge or reduce the pattern so that the lower-left point of the segment is at the lower-left corner of the reference lines on the quilt.

After making adjustments, touch .

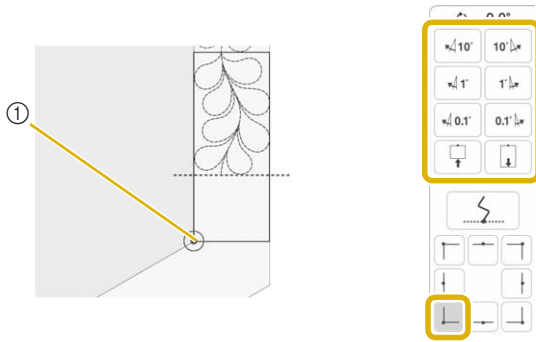

① Inner corner of next pattern to be embroidered

**Memo**

- To maintain the overall shape of the hexagon, it is important to carefully check and adjust the length of the pattern that is stitched immediately before the corner.

③ **When embroidering the corner part**

Rotate the quilt counterclockwise, rehoop it, and then attach the embroidery frame to the machine.

Use the move pattern keys to align the start point projected by the projector with the end point of the previous pattern, and then touch .

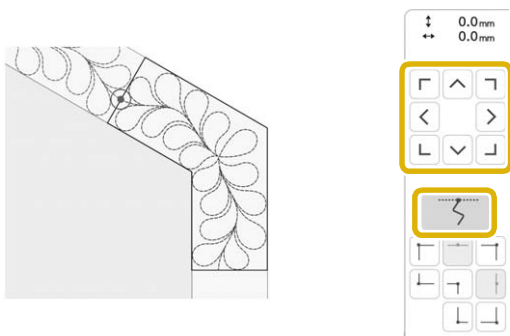

Then, align the inner corner of the pattern with the corner of the reference lines.

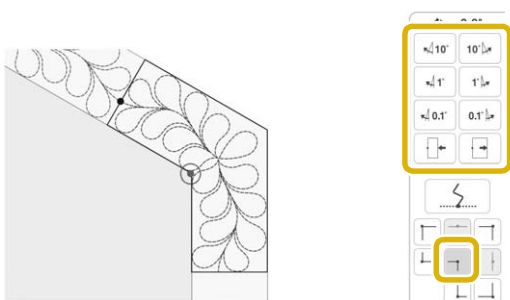

**Memo**

- The width of the corner segment can be adjusted to best fit the inner corner. However, make adjustments so that the shape is not deformed.

④ **When embroidering the last edge part**

Use the move pattern keys to align the start point projected by the projector with the end point of the previous pattern, and then touch .

Then, align the end point of the part with the start point of the first part. If the pattern is not angled correctly, rotate it. If the length of the pattern does not match, enlarge or reduce the pattern.

After making adjustments, touch .

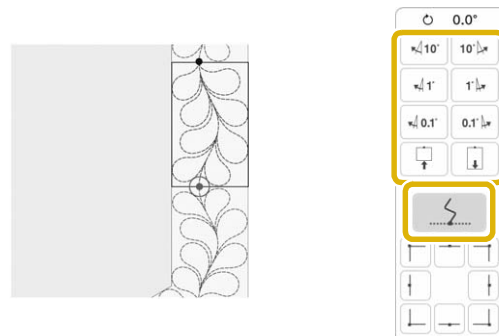

**Memo**

- If you need to restitch a segment or skip a segment, you can touch .

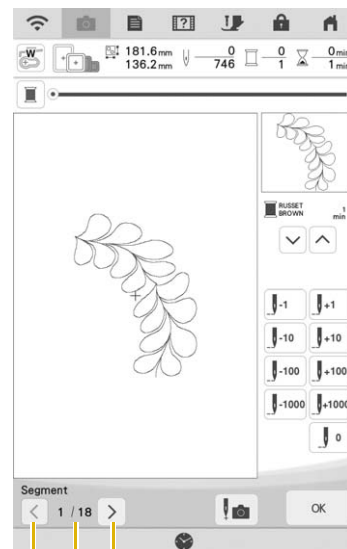

- ① Return to the previous pattern.
- ② Embroidering order of current pattern/Total number of segments
- ③ Continue to the next pattern.



## Embroidering Split Embroidery Patterns

This machine has several built-in large-size split embroidery patterns.

Split embroidery patterns are large patterns that are divided into multiple sections. A large pattern can be created by embroidering the connected pattern sections one after the other.

Additional split embroidery patterns can be created in Palette version 7 or later. For details, refer to the manual for Palette.

There are two methods: one uses the built-in camera to connect the patterns and the other connects the patterns manually.

### Connecting the Pattern Sections with the Camera

#### 1 Touch and then select a pattern.

- \* To ensure the entire large-connect pattern can be successfully embroidered, prepare fabric and stabilizer at least 300 mm (12 inches) longer and wider than total design size.

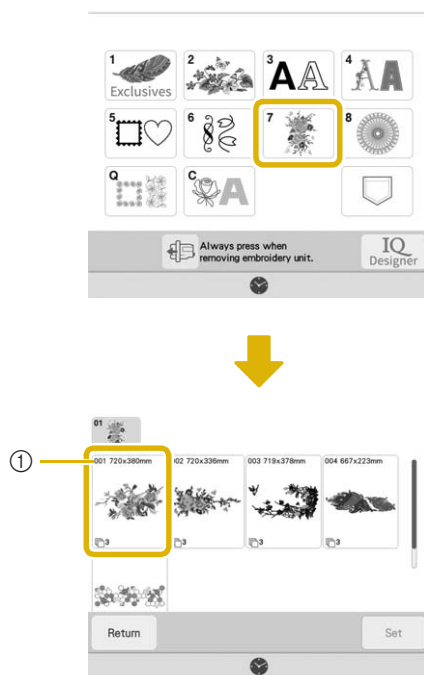

① Size of the entire pattern

#### Memo

- Printable templates of each large-connect design can be downloaded from “[babylock.com/machines/sewing/solaris-vision](http://babylock.com/machines/sewing/solaris-vision)” or “[babylock.com/machines/single-needle-embroidery/solaris-vision](http://babylock.com/machines/single-needle-embroidery/solaris-vision)”. These templates will assist with positioning the patterns. Do not enlarge or shrink the page.
- To embroider split embroidery patterns created with Palette, retrieve the pattern from USB media and so on. For details on recalling patterns, refer to “Retrieving Embroidery Patterns” on page 102. Check the entire pattern size with Palette.

#### 2 Touch the whole pattern icon to connect the pattern sections with the camera. And then touch .

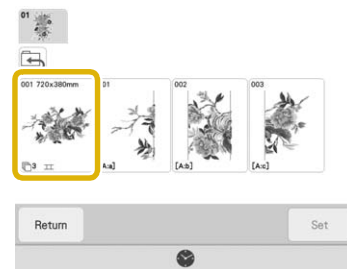

#### Memo

- To connect the pattern sections without using the camera, refer to “Connecting the Pattern Sections Manually” on page 138.

#### 3 Embroider the first pattern.

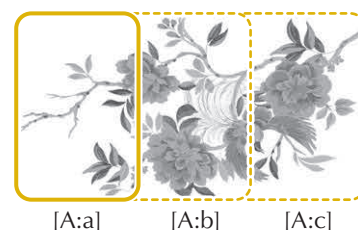
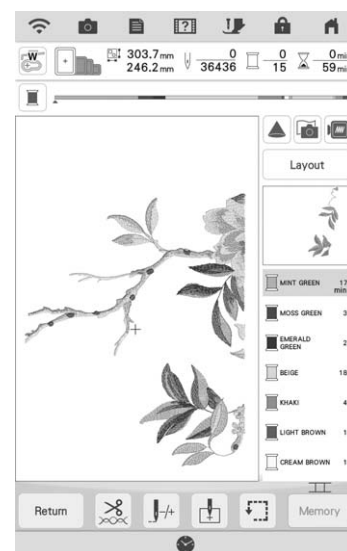

3

Advanced Editing



**4** Touch .

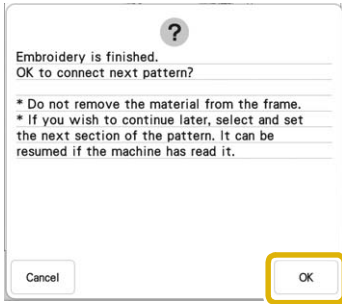

**Note**

- Do not remove the fabric from the embroidery frame.

**5** Touch .



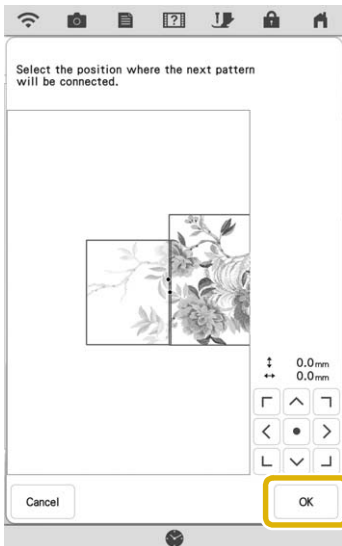

**6** Check the pattern arrangement, and then touch .

- \* Since each built-in pattern has been properly arranged, there is no need to move it.

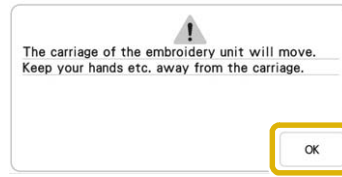

**7** Touch .



**8** Affix the first embroidery positioning sticker onto the fabric within the red lines by using both hands to press down on each corner of the sticker. Affix the sticker with the large circle to the top as shown on machine. Then, touch .

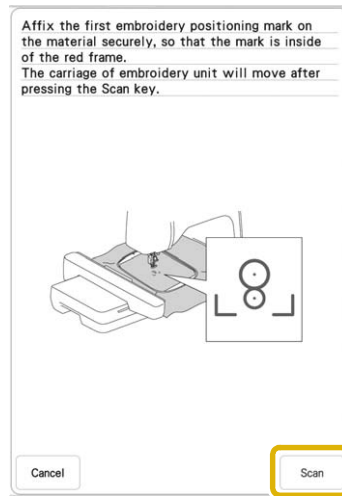

→ The camera detects the first embroidery positioning sticker.

**Note**

- If any of the following messages appear, reattach the embroidery positioning sticker firmly in the correct position.

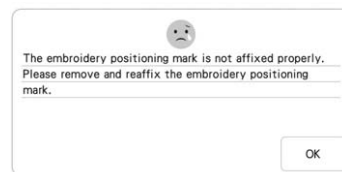

- 9** Affix the second embroidery positioning sticker to the fabric as described in step **8**, and then touch **Scan**.

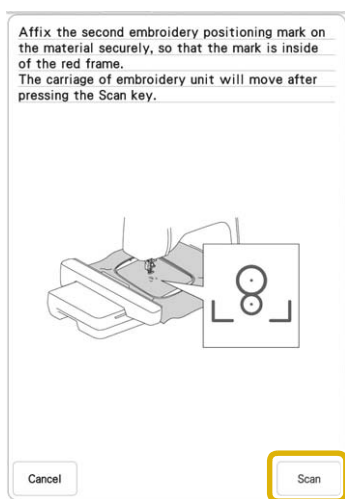

→ The camera detects the second embroidery positioning sticker.

- 10** While making sure that the two embroidery positioning stickers do not peel off, remove the embroidery frame from the machine, and then rehoop the fabric.

\* Be sure to hoop the fabric so the next pattern and both the embroidery positioning stickers are within the embroidery area.

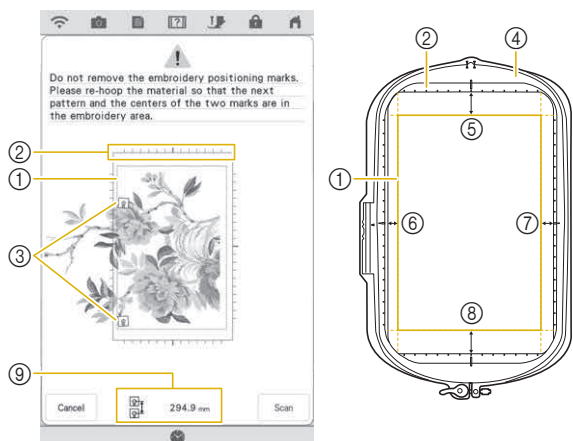

- ① Embroidery area
- ② If a built-in large-size split embroidery pattern is selected and the embroidery frame (408 mm × 272 mm (approx. 16 inches × 10-5/8 inches)) is installed, a scale for the embroidery frame appears in the screen.
- ③ Embroidery positioning stickers
- ④ Embroidery frame (408 mm × 272 mm (approx. 16 inches × 10-5/8 inches))
- ⑤ Approx. 34 mm (Approx. 1-11/32 inches)
- ⑥ Approx. 10.8 mm (Approx. 27/64 inch)
- ⑦ Approx. 15.5 mm (Approx. 39/64 inch)
- ⑧ Approx. 28 mm (Approx. 1-7/64 inches)
- ⑨ Distance between the embroidery positioning stickers

### Memo

- In order to cleanly connect the first and second patterns, make sure that the distance between the embroidery positioning stickers (distance between the centers of the large circles) is the same before and after rehooping the fabric. If the distance is not the same, the fabric may not be taut. At this time, do not correct the distance by moving a sticker.

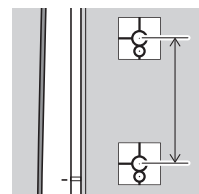

If the following message appears after step **11**, rehoop the fabric so that the distance is the same as that displayed. And then touch

**Scan**.

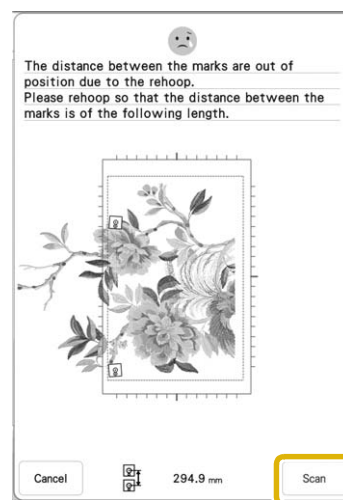

- If the following message appears, rehoop the fabric so that the next pattern and both the embroidery positioning stickers are within the embroidery area as indicated in the screen. If problem persists, refer to “The machine does not detect the embroidery positioning sticker.” on page 196.

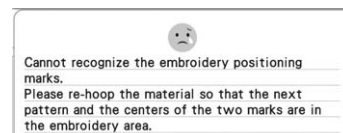

- For best results, if fabric puckers, iron the wrong side of the fabric to smooth out before rehooping. At this time, do not iron over or remove the embroidery positioning stickers.

**11** Reattach the embroidery frame and touch



**12** Touch **OK**, and then remove the stickers.

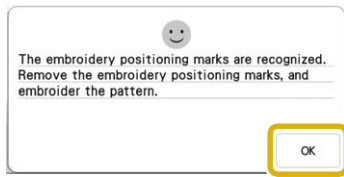

**Memo**

- With a built-in large-size split embroidery pattern, if the distance between the embroidery positioning stickers (distance between the centers of the large circles) differs by a few millimeters before and after the fabric is rehooped, the pattern will be automatically resized.

**13** Embroider the second pattern.

**14** Embroider the remaining patterns in the same way.

**Connecting the Pattern Sections Manually**

**1** Touch and then select a pattern.

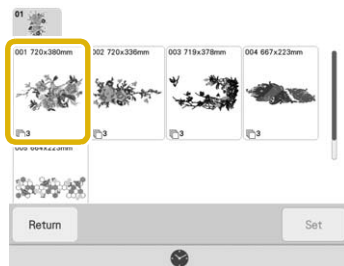

**2** Select section to be embroidered.

\* Select the sections in alphabetical order.

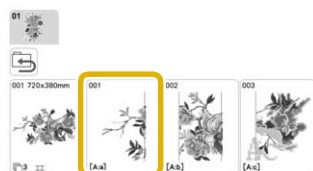

**3** Touch **Embroidery** to display the embroidery screen.

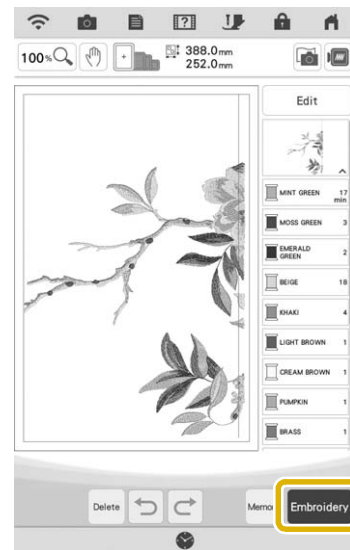

**4** Embroider the first pattern.

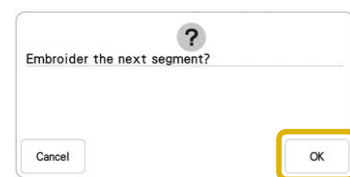

→ The pattern and alignment stitching are embroidered.

**5** Touch **OK**.

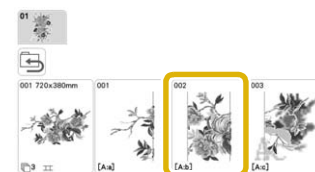

**6** Select the next pattern, and then touch **Embroidery**.



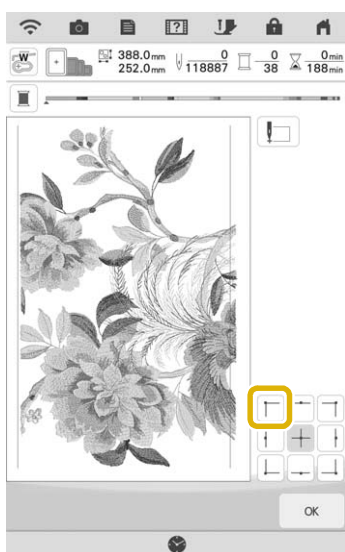

- 7** Rehoop the fabric. Adjust the position and angle for the next pattern so that the alignment stitching embroidered with the first pattern and the needle position for the next pattern are aligned. For this example, touch , select the upper-left needle position, and then touch .



#### Memo

- For best results, if fabric puckers, iron the wrong side of the fabric to smooth out before rehooping.

- 8** Touch , and then adjust the position and angle for the next pattern so that the needle position is aligned with the alignment stitching embroidered with the first pattern.

- \* To adjust the position of the pattern, touch .
- \* To adjust the angle of the pattern, touch .

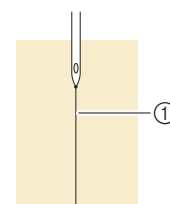
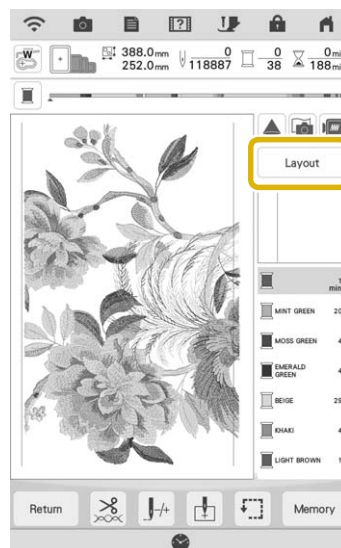

- ① Alignment stitching

- 9** In the same way, select the lower-left needle position, and then adjust the position and angle of the next pattern so that the needle aligns with the thread mark embroidered with the first pattern.
- 10** Embroider the second pattern.
- 11** Embroider the remaining patterns in the same way as with the second pattern.
- 12** Remove the thread marks.

# USING THE CAMERA TO CONNECT PATTERNS

Instead of using thread marks, the camera can be used to connect patterns in the embroidery screen. Select the appropriate frame depending on the size of the embroidery. The distance between the pattern and the embroidery area of the frame must be at least 3 cm (1-3/16 inches). The small embroidery frame (2 cm × 6 cm (1 inch × 2-1/2 inches)) cannot be used with the camera function.

## Connecting Three Patterns

Example:

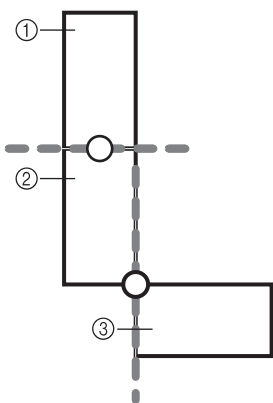

- ① Pattern A
- ② Pattern B
- ③ Pattern C

**1** Select the first pattern A, and then touch **Set**.

\* To select the desired frame, refer to "Selecting Frame Patterns" on page 41.

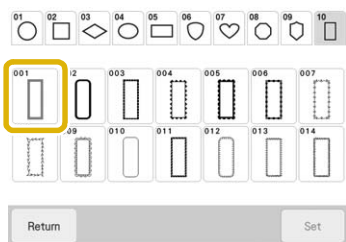

**2** Thread the machine with the upper thread and the bobbin thread.

**3** Hoop fabric in the 18 cm × 13 cm (7-1/8 inches × 5-1/8 inches) embroidery frame, and then attach the frame to the machine.

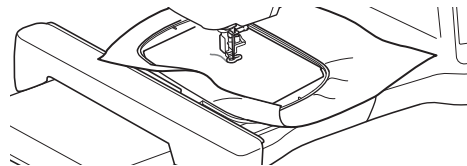



**4** Touch **Embroidery** to display the embroidery screen.

**5** Touch **Layout**.

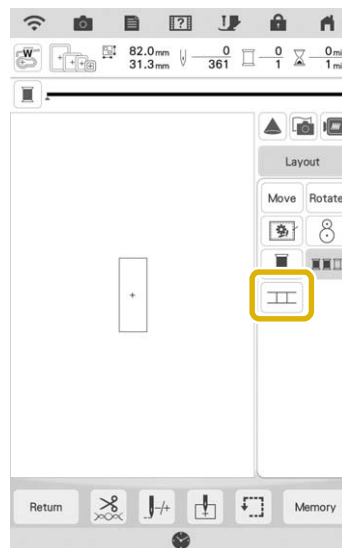
**6** Touch .



→  appears at the bottom right of the screen, and then  changes to .

### Memo

-  can be touched while embroidering.
- A pattern cannot be saved in the machine's memory while patterns are being connected.

**7** Lower the embroidery foot, and then embroider the first pattern.

**8** After embroidering of the first pattern is finished, the following message appears. Touch **OK**.

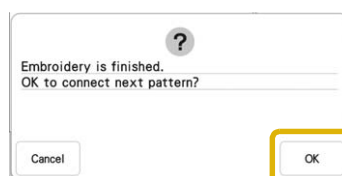

9 When the following message appears, touch

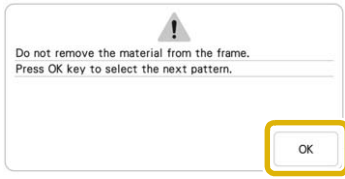

10 Select the second pattern B, and then touch

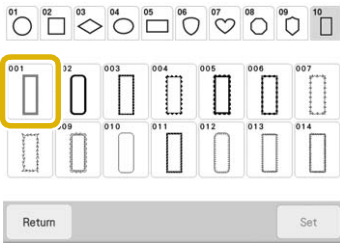

11 Touch , and then select how the patterns will be connected.

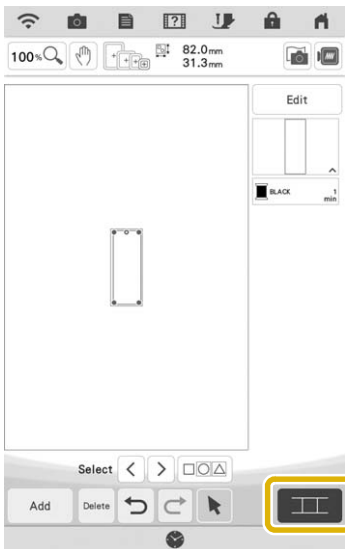

→ The pattern connection setting screen appears.

**Memo**

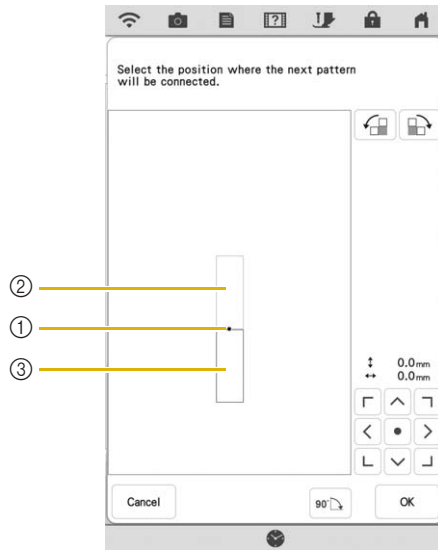

- You can edit the second pattern in this screen.

12 Select the position of the second pattern by touching on the screen. Touch  after specifying the position.



- ① Connecting point
- ② First pattern A
- ③ Second pattern B

\* You can adjust the position of the second pattern using the keys described below.

	Touch to rotate the second pattern in a clockwise arc referring the first pattern as a center.
	Touch to rotate the second pattern in a counterclockwise arc referring the first pattern as a center.
	Rotate the second pattern 90 degrees in a clockwise arc.

→ Message appears on screen and carriage will move after touching .

**Memo**

- The second pattern will be automatically connected to the first pattern without adjustment. Change the position of the

second pattern manually using .

- The position of the second pattern can also be moved by dragging on the screen.



**13 Prepare two embroidery positioning stickers. Follow the on-screen instructions to affix the two stickers to the fabric so that the positioning marks can be detected by the camera.**

**Note**

- Use the embroidery positioning stickers included with this product or purchase replacement stickers (BLSO-EPS) from your authorized Baby Lock retailer. If any other sticker is used, the camera may not recognize it.

**14 Affix the first embroidery positioning sticker onto the fabric within the red lines that now appear on the screen of the machine by using both hands to press down on each corner of the sticker. Affix the sticker with the large circle to the top as shown on machine. Then, touch .**

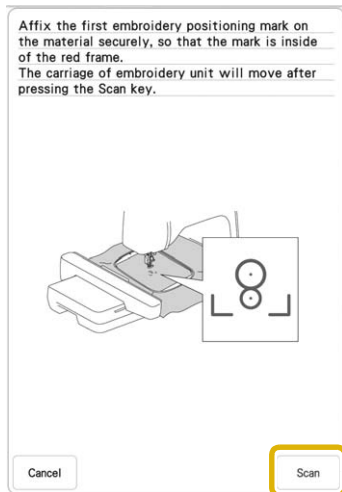

→ The camera detects the first embroidery positioning sticker.

**Note**

- Do not peel off the first embroidery positioning sticker to use it for the second embroidery positioning mark.
- Use new embroidery positioning stickers. If a sticker is reused, it may easily peel off. If the sticker peels off during this procedure, the patterns cannot be connected.
- Use your fingers to apply pressure to the corners of the embroidery positioning sticker to firmly affix it to the fabric. If the sticker is not firmly attached, the camera may incorrectly detect the sticker.
- If any of the following messages appear, reattach the embroidery positioning sticker in the correct position. Make sure that the sticker is affixed with the large circle at the top.

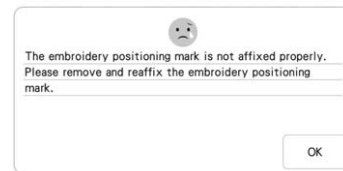
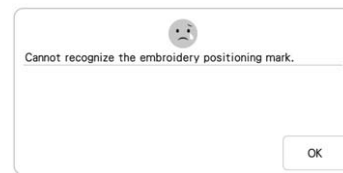

**15 Use both hands to affix the second embroidery positioning mark within the red lines that now appear on the machine by pressing down on each corner of the positioning mark onto the material and then touch .**

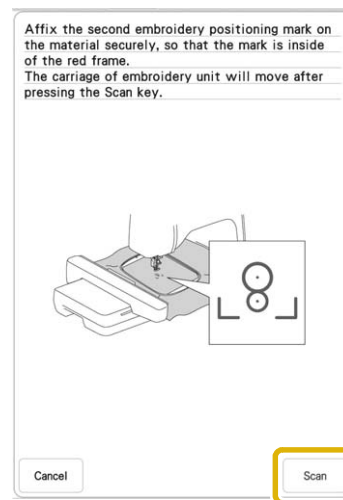



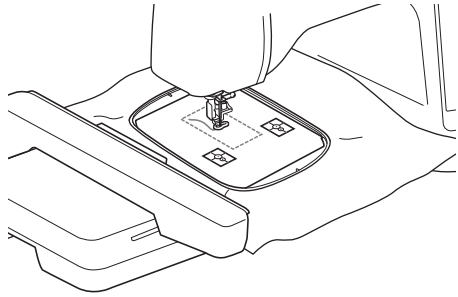

→ The camera detects the second embroidery positioning sticker.

**16** After the two embroidery positioning stickers have been detected, the following message appears.

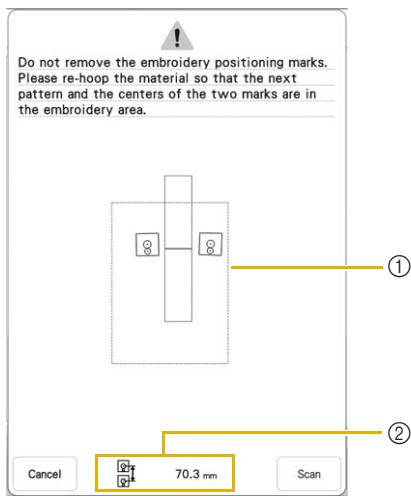

- ① Embroidering area
- ② Distance between the embroidery positioning stickers (Refer to “Memo” of step 10 on page 137)

**While making sure that the two embroidery positioning stickers do not peel off, remove the embroidery frame from the machine, and then rehoop the fabric. Be sure to hoop the fabric so the next pattern and both the embroidery positioning stickers are within the embroidery area. Reattach the frame and touch .**

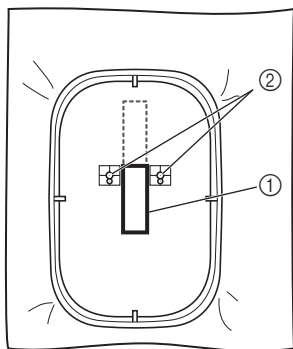

- ① Pattern to be embroidered next
  - ② Centers of large circles for stickers
- The camera detects the two embroidery positioning stickers.

**Note**

- If either of the following messages appear, rehoop the fabric so that the next pattern and both the embroidery positioning stickers are within the embroidery area as indicated in the screen.

Touch  to detect the embroidery positioning stickers.

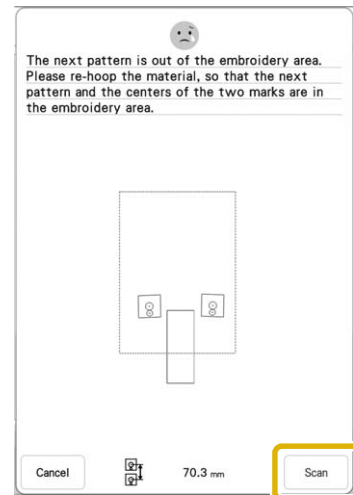
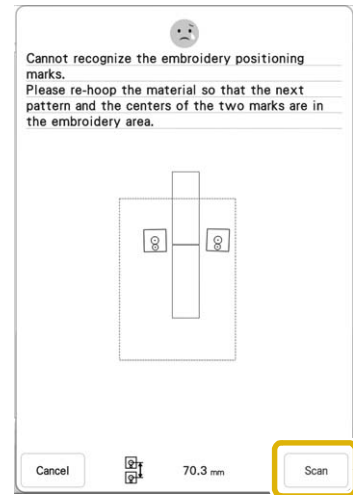

- If the machine detects that the next pattern and the centers of the large circles of the two embroidery positioning stickers do not fit within the embroidering area, the operation will be paused. Follow the on-screen instructions to reposition the embroidery positioning stickers. Refer to “Changing the Position of a Sticker” on page 145 to reposition the stickers.
- If the sticker peels off during this procedure, the patterns cannot be connected. If this occurs, restart the procedure from the beginning.
- To quit positioning, touch .

**17** After the embroidery positioning stickers have been detected, touch , and then remove the stickers.

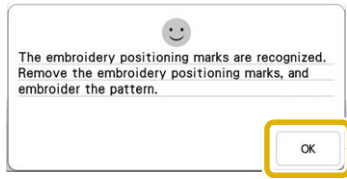

**18** Lower the embroidery foot, and then embroider the second pattern.

→ When embroidering is finished, the following message appears.

To connect a third pattern, touch .



**19** When the following message appears, touch .

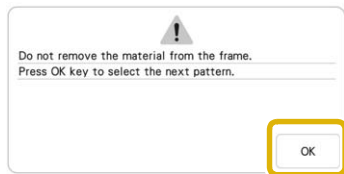

**20** Select the third pattern C, and touch .

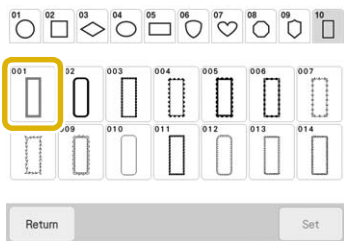



**21** Touch , and then select how the patterns will be connected.

→ The pattern connection setting screen appears.

**Memo**

- You can edit the pattern before selecting .

**22** Specify the position of the third pattern referring to the screen display.

In this example, touch  2 times to select the connection point, and then touch . Touch  after specifying the position.

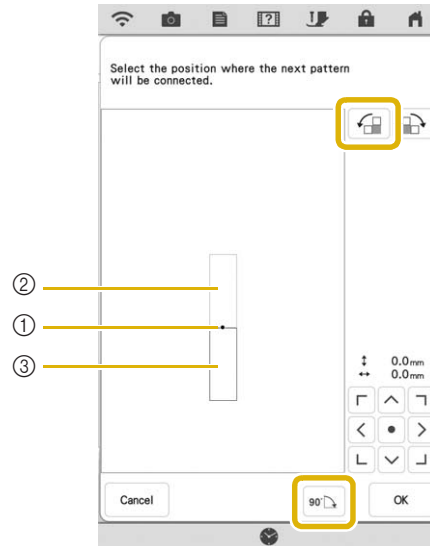

- ① Connecting point
- ② Second pattern B
- ③ Third pattern C

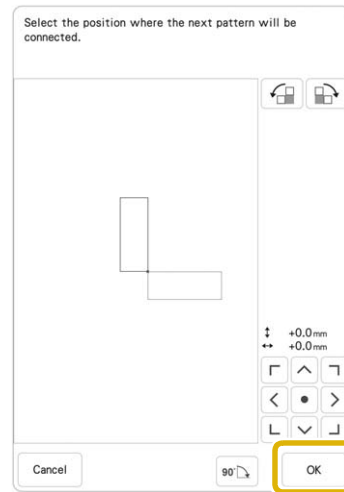



→ Message appears on screen and carriage will move after touching .

Follow steps **14** - **17** on pages 142-144 to position the next pattern.

**23** Lower the embroidery foot, and then embroider the third pattern.

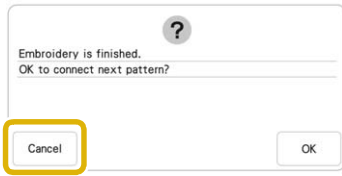
→ When embroidering is finished, the following message appears. When finished connecting patterns, touch **Cancel**.



→ After embroidering is finished,  is no longer located at the bottom right of LCD screen. The three patterns have been connected.

## Changing the Position of a Sticker

If the selected pattern or embroidery positioning stickers for connecting the next pattern do not easily fit in the embroidering area, follow the on-screen instructions that appear after step 15 on page 142 in order to move the embroidery positioning stickers. For an example, the on-screen instruction appears when you use the embroidery frame with a size of 10 cm × 10 cm (4 inches × 4 inches) to connect patterns as shown below.

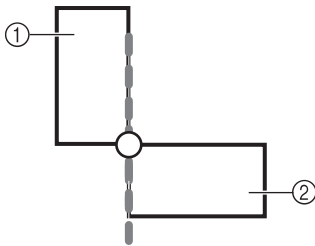

- ① Pattern A
- ② Pattern B

**1** Refer to steps 1 through 15 of “Connecting Three Patterns” using the embroidery frame with a size of 10 cm × 10 cm (4 inches × 4 inches) to embroider the first pattern and to connect the second pattern.

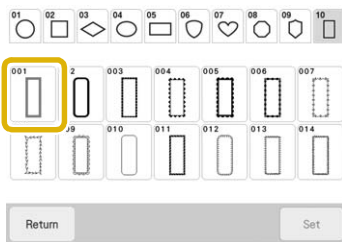

**2** Following message appears in step 16 if the next pattern or affixed embroidery positioning stickers are close to being out of the embroidering area. Follow the instructions and then touch **Scan**.

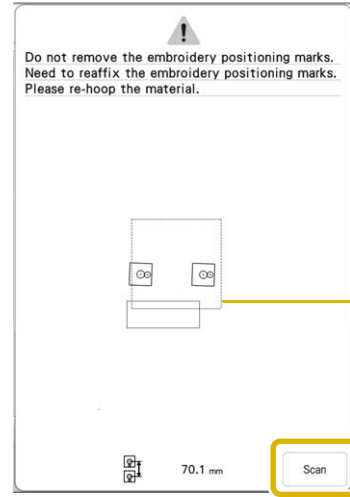

① Embroidering area

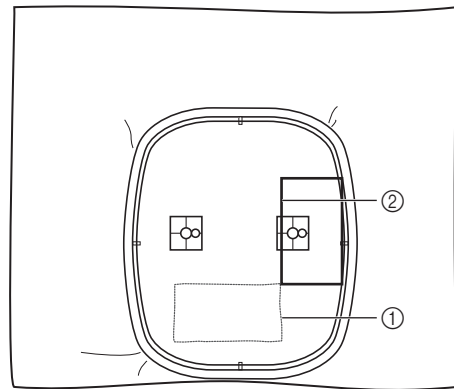

- ① First pattern that was embroidered
- ② Pattern to be embroidered next

**Note**

- If the following message appears, rehoop the fabric as indicated in the screen, and then touch **Scan**.

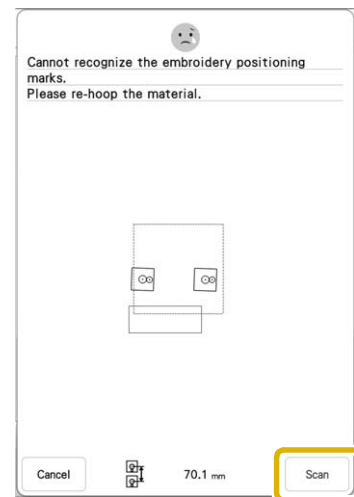

**3** After the sticker position is detected, touch **OK**, and then remove the stickers.

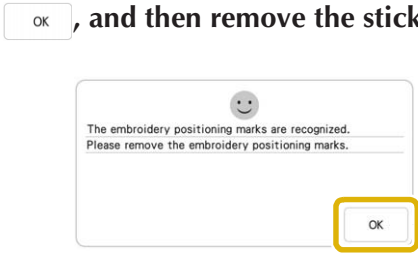

**4** Affix the two embroidery positioning stickers again according to the on-screen instructions so that the next pattern or positioning marks can fit in the embroidery area. Affix the first sticker and then touch

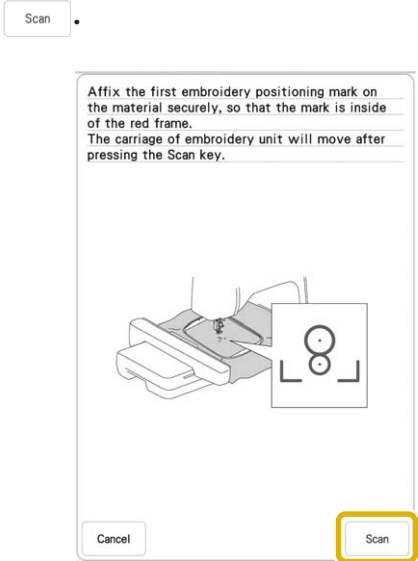

→ The camera detects the first embroidery positioning sticker.

**5** Affix the second sticker and then touch

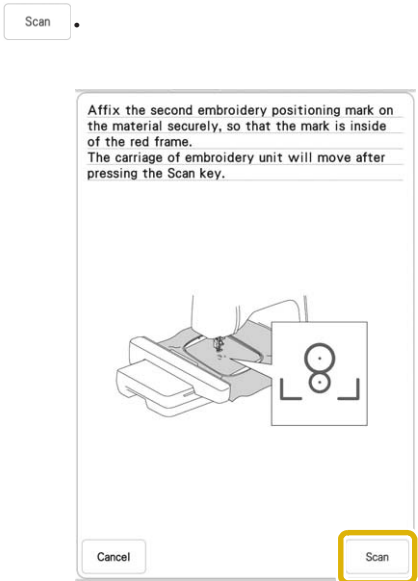

→ The camera detects the second embroidery positioning sticker.

**6** After the two embroidery positioning stickers have been detected, the following message appears. While making sure that the embroidery positioning stickers do not peel off, rehoop the fabric according to the example displayed on the on-screen instruction.

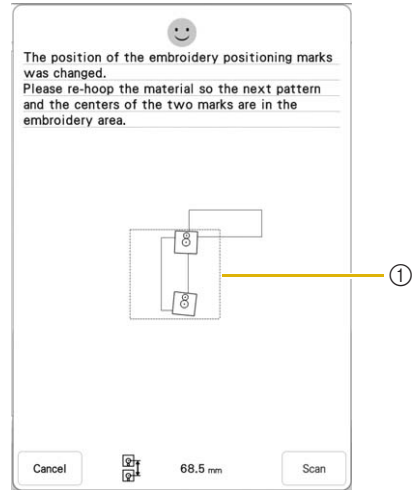

① Embroidering area

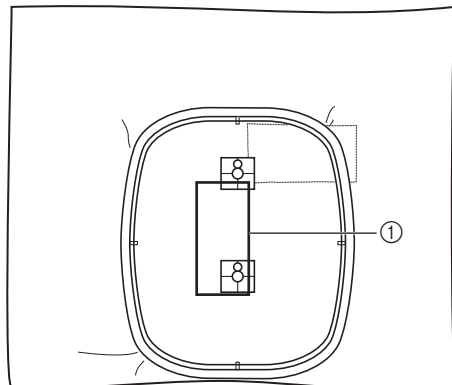

① Pattern to be embroidered next

**7** Continue the operation from step 17 on page 144 after touching **OK**.

## Resume Feature

If the machine is turned off while the pattern connecting function is being used, the machine will return to the operation indicated below when it is turned on again. The machine operation will differ depending on when it is turned off.

### Example: When connecting two patterns

Select the first pattern. Touch the pattern connection key . Begin embroidering the first pattern.



#### Finish embroidering the first pattern. (A)

If the machine is turned off during any operation in this box, the machine will return to (A) when it is turned on again.



Select the second pattern.



Touch .



Specify the reference point for connecting the pattern.



Start detecting embroidery positioning stickers (2 locations).



#### Finish detecting embroidery positioning stickers. (B)

If the machine is turned off during any operation in this box, the machine will return to (B) when it is turned on again.

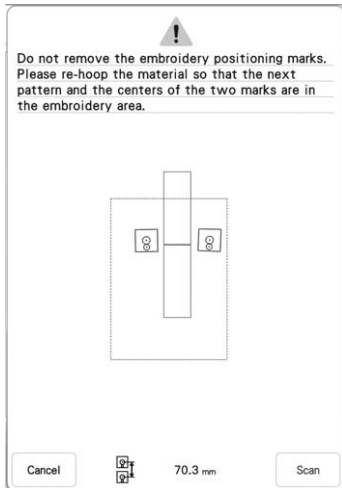

Rehoop the fabric.



#### Finish detecting embroidery positioning stickers (2 locations).

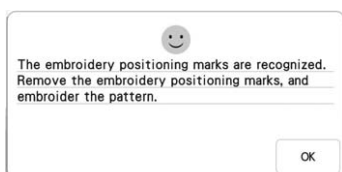

Begin embroidering the second pattern.



Finish embroidering the second pattern.





Chapter **4**  
**IQ Designer**





## ABOUT IQ DESIGNER

With IQ Designer, you can use the functions listed below:

- Hand-drawn functions - create embroidery patterns by drawing on the LCD screen
- Scanning functions - create embroidery patterns by not only scanning drawings /illustrations with built-in camera, but also importing data from USB media, etc.
- IQ Intuition- Positioning App - create embroidery patterns by sending images from your smart device to your machine

You can also combine patterns that you have created with the machine's built-in patterns.

Start IQ Designer by touching  in the home page screen or touching  in the embroidery pattern selection screen.

### IMPORTANT

- **Only touch the screen with your finger, the included dual purpose stylus or fine tipped stylus pen. Do not use a mechanical pencil, screwdriver or any other hard or sharp object. In addition, do not press the screen with extreme pressure. Otherwise the screen may be damaged.**

 **Note**

- All or part of the screen may sometimes become darker or lighter due to changes in the surrounding temperature or other changes in the environment. This is not a sign of a malfunction. If the screen is difficult to read, adjust its brightness.

## PATTERN DRAWING SCREEN

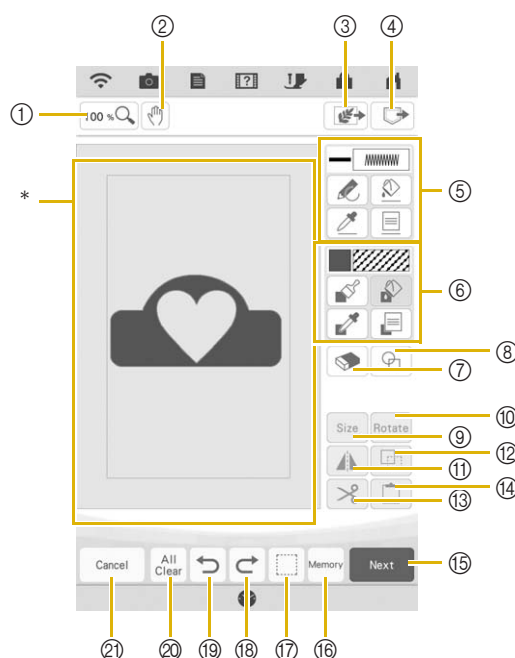

\* Pattern drawing area

 **Memo**

- The actual dimension of the pattern area is the size of the embroidery frame, which is 408 mm × 272 mm (approx. 16 inches × 10-5/8 inches). The pattern you drew may be bigger than you expected. Please resize the pattern after converting the design to the embroidery pattern.

## ■ Key Functions

No.	Display	Key Name	Explanation	Page
①		Magnify key	Touch this key to magnify the pattern.	154
②		Hand key	Touch this key to move the canvas when it is magnified.	—
③		Scan key	Touch this key to select background image scanning, line scanning or illustration scanning.	165, 169, 172
④		Recall key	Touch this key to recall pattern drawing data (.pm9) created with IQ Designer from the machine's memory, USB media, or SD card.	—
⑤		Line tool key	Draw lines and set the color. You can select the line type, stitch type and color as you need. Touch  to pick up the color and stitch type from a line in the pattern within the pattern drawing area. The picked-up color is shown as the currently selected line color in the color bar and the Line Property screen.	152
⑥		Brush tool key	Paint with brush and set the color. You can select the brush type, fill type and color as you need. Painted lines and areas will be converted to the pattern embroidered with fill stitch. Touch  to pick up the color and fill type from a region in the pattern within the pattern drawing area. The picked-up color is shown as the currently selected region color in the color bar and the Region Property screen.	154
⑦		Erase key	Touch this key to erase lines and shapes that have been drawn. You can select the size/shape of the eraser.	157
⑧		Stamp key	Touch this key to select the stamp shape for pattern drawing.	156
⑨		Size key	Touch this key to change the size of the selected section.	158
⑩		Rotate key	Touch this key to rotate the selected section.	156
⑪		Mirror image key	Touch this key to create a mirror image of the selected pattern.	—
⑫		Duplicate key	Touch this key to duplicate the selected section. The temporarily positioned section can immediately be rotated, enlarged, reduced or moved.	—
⑬		Cut key	Touch this key to cut out the selected section.	—
⑭		Paste key	Touch this key to paste in the selected section duplicated with the duplicate key or a selected section using the cut key.	—
⑮		Next key	Touch this key to continue to the stitch settings screen.	—
⑯		Memory key	Touch this key to save the pattern drawing data (.pm9).	—
⑰		Select key	Touch this key to select a section for moving, copying, deleting, changing size and rotating lines and shapes that have been drawn.	157
⑱		Redo key	Touch this key to redo the operation that was undone with the undo key. Each touch of this key will redo one operation.	—
⑲		Undo key	Touch this key to undo the last operation that was performed and return to the previous state. Each touch of this key will undo one operation.	—
⑳		All Clear key	Touch this key to clear all the lines and shapes and start from the beginning. The background image is also cleared.	—
㉑		Cancel key	Touch this key to exit from IQ Designer. All lines and shapes are erased when you touch this key.	—

## Before Creating Designs

The pattern preview displays the design smaller than the actual size. You can view the actual pattern size by setting the [Embroidery Frame Display].

With [Embroidery Frame Display] in the settings screen, the embroidery frame and grid can be specified separately. For details on the types of embroidery frames and grids available, refer to "Changing the Embroidery Frame Display" on page 97.

1 Touch .

2 Select the grid line and embroidery frame in the Embroidery Frame Display menu.

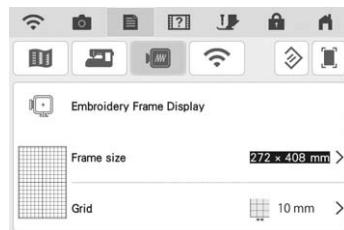
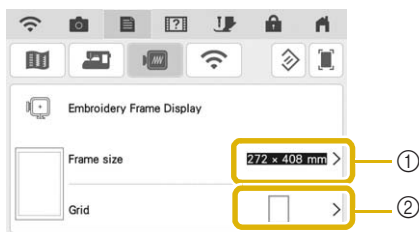

- ① Embroidery frame types
- ② Grid types

## Drawing Lines

1 Touch  and draw lines.

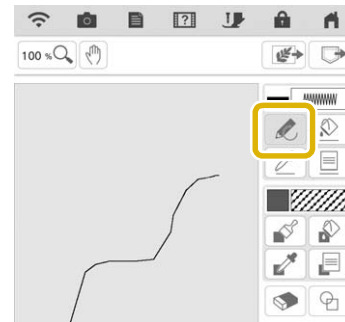

### Memo

- When  is touched, all regions will be displayed in the background to clarify the drawing lines on the screen.

## ■ Setting the Line Types, Stitch Types and Colors

You can set or change the line types, stitch types and colors anytime. You can also specify the line types, stitch types and colors before drawing lines.

**1** Touch  to set the line types, stitch types and colors.

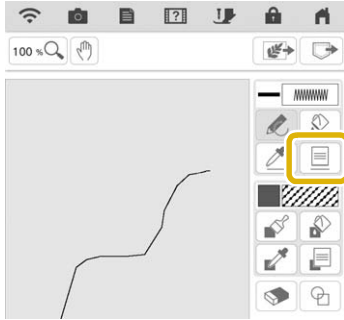





→ The settings screen appears.













- ① Line types
- ② Stitch types
- ③ Line color selection: touch the color palette to activate the drawing pen color.

### Line types

	Freehand line with the end open.
	Freehand line closing the end automatically.
	Straight line with one stroke.
	Straight line changing directions to the point you select. If the end point is created near the start point, a closed object will be created.

### Stitch types

	Zigzag stitch
	Running stitch
	Triple stitch
	Candlewicking stitch
	Chain stitch
	E stitch
	V stitch
	Select motif stitches Displays motif stitch selection screen, where  can be touched to select a pattern.
	Line without stitch for creating a region. Created region will be defined by the gray line.

**2** Touch  to return to the pattern drawing screen.

→ You can check the selected stitch type and color.

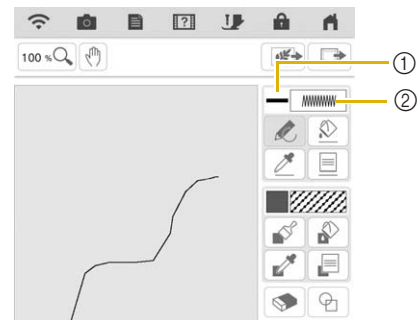



- ① Color bar
- ② Stitch type

**3** Touch  then touch on the line to change its color.

→ The selected line will be changed to the selected color.

**Memo**

- Touch  to magnify the image when you cannot touch on the line correctly. For details on magnify the image, refer to “Displaying Patterns in the Screen Magnified” on page 68.
- Touch , and then select a color within the pattern drawing area to apply the same color to other lines or parts of the pattern.

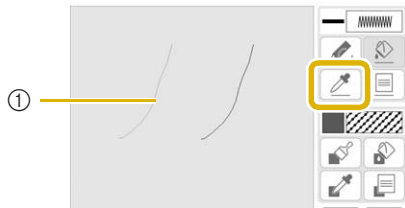

① Use  to select the line color.

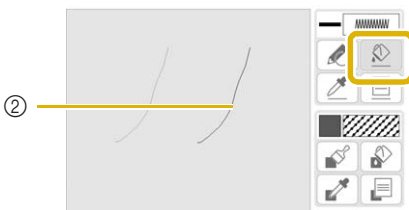

② Touch  for changing the line color, and then select the pattern to be changed.

## Drawing Regions

**1** Touch  and draw with brush.

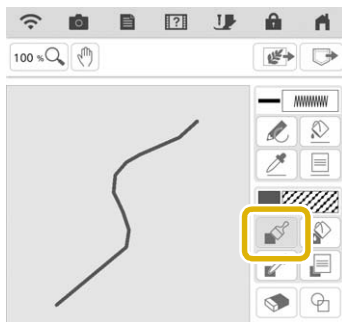

## Setting the Brush Types, Fill Patterns and Fill Colors

**1** Touch  to set the brush types, fill patterns and fill colors.





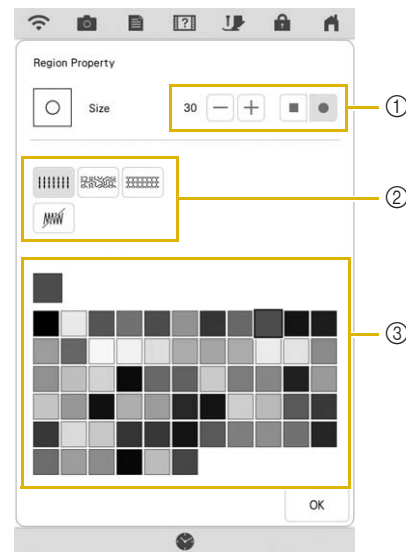



→ The setting screen appears.





- ① Brush types
- ② Fill stitch types
- ③ Fill color selection: touch the color palette to activate the paint brush color.

### Brush shapes

	Square brush	
	Round brush	

To select the brush size, touch  or .

### Fill stitch types

	Fill stitch pattern
	Stippling pattern
	Select decorative fill patterns Displays a fill pattern selection screen, where <b>Select</b> can be touched to select a pattern.



Select  when you don't want fill stitches.

### 2 Touch to return to the pattern drawing screen.

→ You can check the selected stitch type and color.

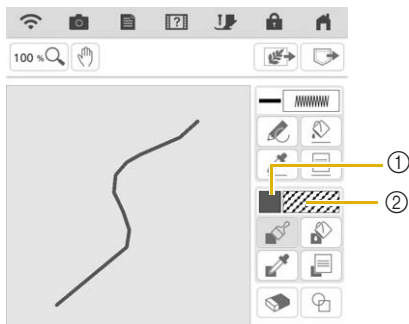



- ① Color bar
- ② Stitch type

\* If a stippling pattern or decorative fill pattern has been specified, the stitch pattern is displayed.

### 3 Touch and touch on the brush line to change color and fill stitch types. You can also set the fill color, stitch type and fill pattern of a closed area made of the lines and brush lines.

#### Memo

- Touch  to magnify the image when you cannot touch on the fill correctly.
- Touch , and then select a pattern color in the pattern drawing area to apply that fill color and stitch type to other patterns.

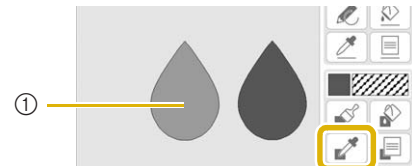

① Use  to select the pattern.



② Touch  for changing the fill color and stitch type, and then select the pattern to be changed.

# Using the Stamp Key

1 Touch .

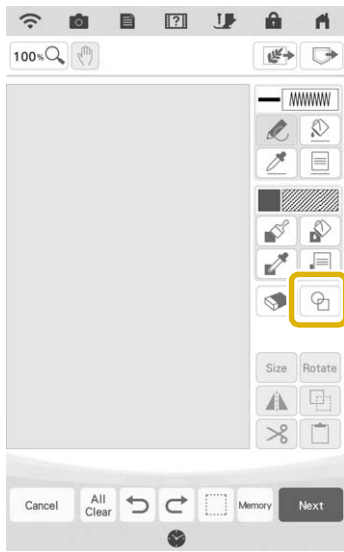

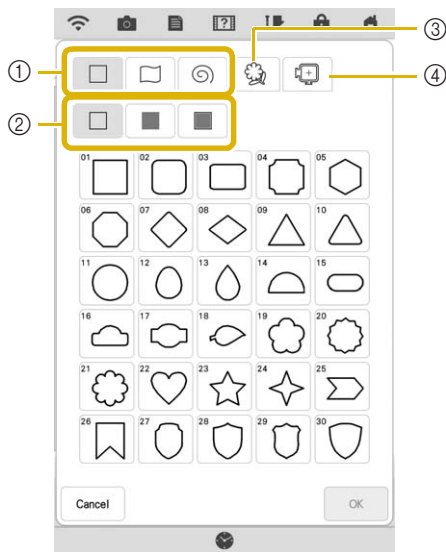

2 Select a stamp type and stamp shape.









- ① Stamp shapes
- ② Stamp types
- ③ Saved outlines
- ④ Frame embroidering areas

## Stamp shapes

	Basic shapes
	Closed shapes
	Open shapes

## Stamp types (Only for Basic shapes)

	Outline
	Fill stitch
	Outline and fill stitch

\* Select the outline () , fill stitch () , or outline and fill stitch () of a basic shape.

## Saved outlines

 Embroidery pattern outlines can be registered as stamp shapes. When registering stamp shapes, select from the last 20 embroidery patterns used. If more than 20 shapes are registered, the oldest one is automatically erased. For details on registering a stamp shape, refer to “Decorative Stitching Around a Pattern in Embroidery (a Quilting Function)” on page 185.

## Frame embroidering areas



 Select an embroidering area in order to arrange the pattern to fit an embroidery frame. If an offset value is specified, a shape offset to the inside is displayed. When making a frame pattern using a motif stitch, etc., specify an offset value according to the pattern size so the pattern can fit within the embroidering area for the selected embroidery frame.



\* Touch  to return to the pattern drawing screen.

3 Touch  to set the selected stamp.

→ The pattern drawing screen is displayed.

\* You can change size of, rotate or move the shape right after you create it by touching  or .



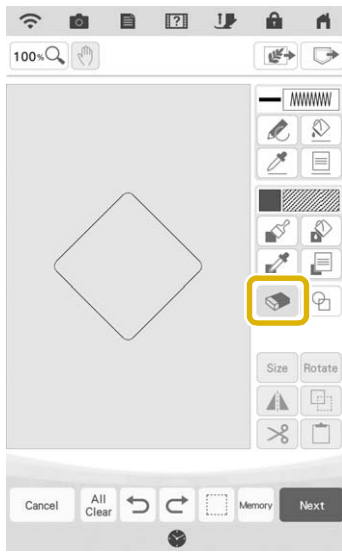

## Using the Erase Key

1 Touch .

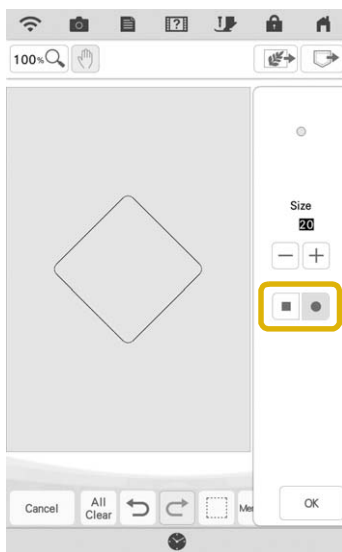

2 Select the shape of the eraser. And then drag along the area or line that you want to erase.



\* To select the eraser size, touch  or .

3 Touch .

### Memo

- The area or lines can be erased while the key appears as .

## Using the Select Key



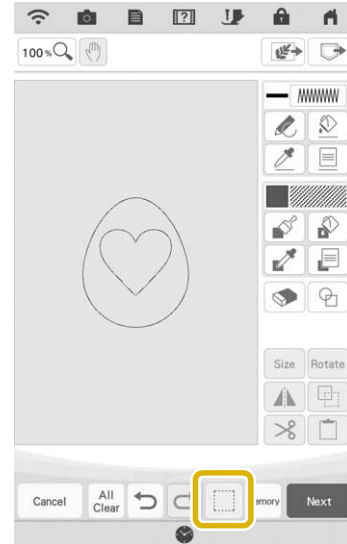

You can select the part of the design to move and/or edit. Some keys are available only after you select the part.

1 Touch .



2 Select the method for selecting an area.



	Box selection	Selects all objects within the box that is drawn.
	Polygonal shape selection	Selects all objects within the polygonal shape that is drawn.
	Freestyle curve selection	Selects all objects within the curved line that is drawn.
	Automatic selection	Selects the pattern that is touched. This allows you to select only a single line or only the outer pattern of a donut shape.
	Select all	Selects all patterns.

**3** Select the area you want to edit, and then touch **Close**.

\* Drag to create the red box around your selected area to be edited.

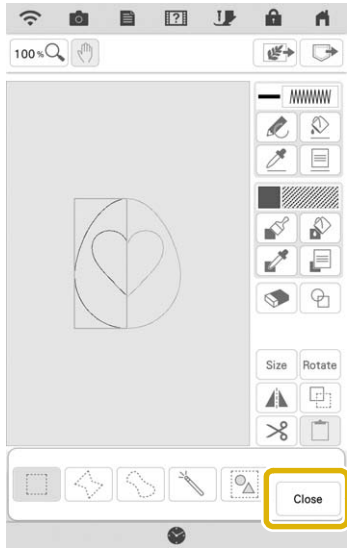

**4** Edit the design with available keys. (Refer to "Key Functions" on page 151 for the details of each key function.)

**5** Touch **Next**, and then specify the stitch setting.

## Using the Size Key

**1** Touch **Size**.

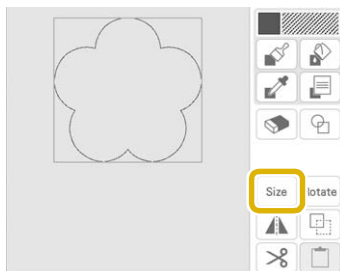

**2** Select the direction in which to change the size.

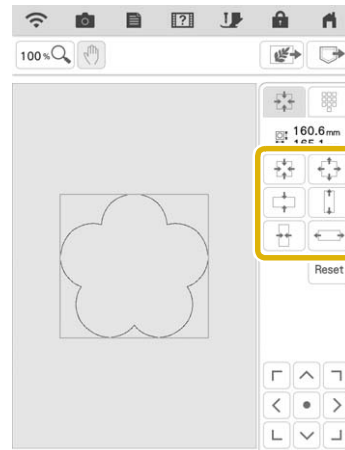

**3** Touch **OK**.

## Entering the Size

**1** Touch **Size**, and then touch **Size**.

**2** Touch the box for the height or width, specify a value with the number keys, and then touch **Set**.

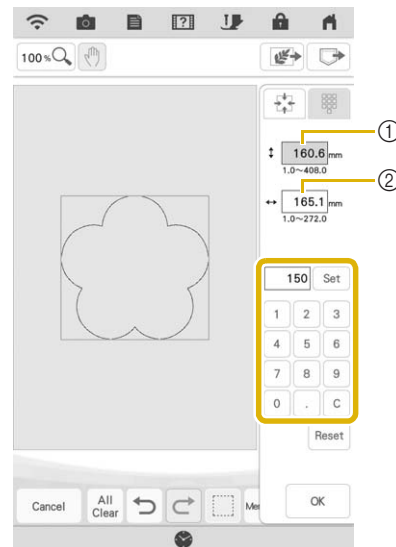

- ① Box for height
- ② Box for width

**3** Touch **OK**.

## Importing Motif Stitch Pattern Data or Decorative Fill Pattern Data

Motif stitch pattern data (.pmf) or decorative fill pattern data (.plf) created in [Programmable Stitch Creator] of Palette can be imported into IQ Designer.

- \* Motif stitch pattern data (.pmf) can be created on Palette version 4 or later. Decorative fill pattern (.plf) can be created on Palette version 11 or later.

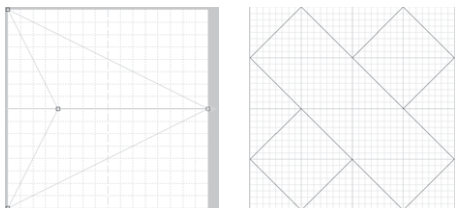

- 1 Save the motif stitch pattern data (.pmf) and/or decorative fill pattern data (.plf) in the USB media.
- 2 Insert the USB media into the USB port on the machine.
- 3 Touch [IQ Designer].
- 4 To import motif stitch pattern data (.pmf), touch . After the Line Property screen appears, touch , then **Select**.

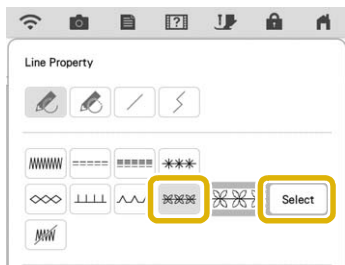
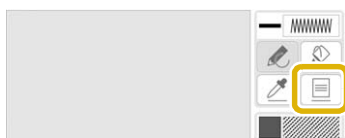

- 5 Touch [Custom], then .

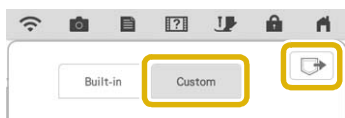

- 6 Touch the key for the USB port where the USB media has been inserted, select the motif stitch pattern data (.pmf), and then touch **OK**.



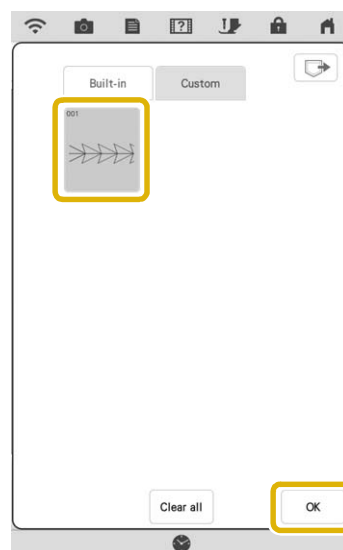

→ The motif stitch pattern data is saved to the machine.

- 7 Select the motif stitch pattern to be used, and then touch **OK**.



### Memo

- Saved motif stitch patterns are assigned a pattern number. The pattern number appears in the upper-left corner of the key.
- Up to 12 motif stitch patterns can be saved to the machine. When trying to save more motif stitch pattern data than this maximum, a message will appear. Follow the on-screen instructions, and select the pattern number of the motif stitch pattern data to be replaced.
- Touch **Clear all** to delete all saved motif stitch pattern data.

**8** To import decorative fill pattern data (.plf), touch . After the Region Property screen appears, touch , then .

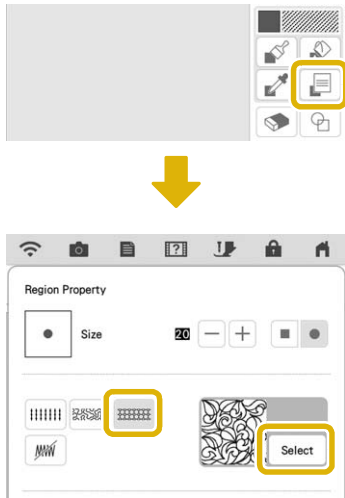

**9** Refer to steps **5** through **7** to select an imported decorative fill pattern.

**10** Edit the pattern. If necessary, touch  to save the pattern.

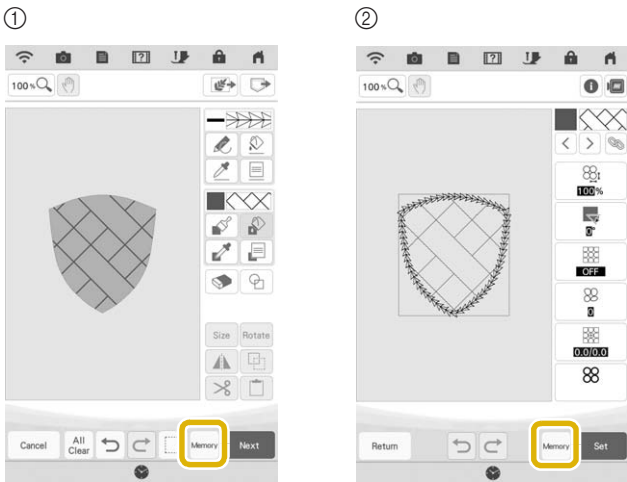

① Pattern drawing screen  
 ② Stitch settings screen

**Memo**

- When saving a pattern (that contains an imported motif stitch pattern or decorative fill pattern) as pattern drawing data (.pm9), it can only be saved in the machine's memory.
- When recalling a saved design, the motif stitch pattern or decorative fill pattern currently saved under the assigned pattern number is imported. (If the custom stitch pattern that was assigned to a saved design has been replaced by another custom stitch pattern, the original stitch pattern will not be recalled. It will be replaced with the replacement stitch pattern.)
- If all custom stitch patterns are cleared, the custom stitch pattern that was assigned to a saved design will not be recalled. It will be replaced with a default stitch pattern. Patterns with deleted custom motif patterns will be recalled with a zigzag stitch. Patterns with deleted custom decorative fill patterns will be recalled with a standard fill stitch.
- If the design is saved on the embroidery edit screen after touching  on stitch settings screen, the custom motif and decorative fill pattern will be preserved.

# STITCH SETTINGS SCREEN

After creating the pattern drawing data (.pm9) in the drawing screen (page 150), you will have an opportunity to:

- Check and change the stitch settings for each line and region.
- Save the pattern drawing data (.pm9).
- Convert the data to an embroidery pattern (.phx), proceed to the embroidery edit screen, and/or save the embroidery pattern.

## Specifying Individual Stitch Settings

Select a pattern in the stitch settings screen to specify its line and region stitch settings. If multiple patterns are selected, the settings are applied to those patterns.

### Line Settings

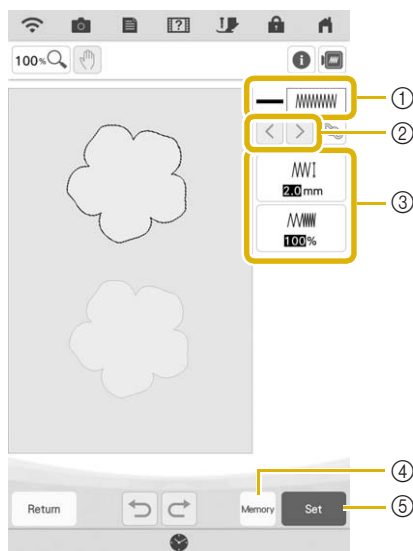

- ① Shows/Changes the stitch type and color for the selected line.
- ② Select the line to be changed.
- ③ Shows/Changes the stitch settings for the selected line.
- ④ Save the pattern drawing data (.pm9) and embroidery data (.phx).
- ⑤ Proceed to embroidery edit screen.

### Line stitch settings

Select the type of stitching you want applied to your line art.

Zigzag stitch

[Zigzag width]	Specifies the width of the stitch.
[Density]	Specifies the density of the stitch.

Running stitch /Triple stitch

\* Both includes an under sewing.

[Run pitch]	Specifies the length of the stitch.
-------------	-------------------------------------

Candlewicking Stitch

[Size]	Increases/reduces the size of the pattern.
[Spacing]	Specifies the spacing of the candlewicking stitch.

Chain stitch

[Size]	Increases/reduces the size of the pattern.
[Thickness]	Sets repeated embroidering at the same part.

E stitch

[Stitch width]	Increases/reduces the size of the pattern.
[Spacing]	Specifies the spacing of the E stitch.
[Thickness]	Sets repeated embroidering at the same part.
[Flip]	Specifies if the decorative line shows up inside or outside.

V stitch

[Stitch width]	Increases/reduces the size of the pattern.
[Spacing]	Specifies the spacing of the V stitch.
[Thickness]	Sets repeated embroidering at the same part.
[Flip]	Specifies if the decorative line shows up inside or outside.

Motif stitch

[Size]	Increases/reduces the size of the pattern.
[Spacing]	Specifies the spacing of the motif stitch.
[Flip]	Specifies if the decorative line shows up inside or outside.

## Region Settings

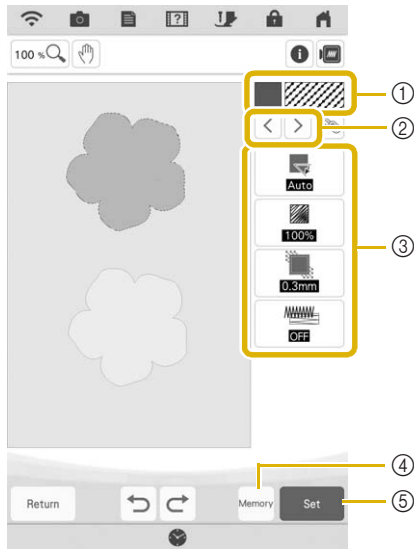

- ① Shows/Changes the stitch type and color for the selected region.
- ② Select the region to be changed.
- ③ Shows/Changes the stitch settings for the selected region.
- ④ Save the pattern drawing data (.pm9) and embroidery data (.phx).
- ⑤ Proceed to embroidery edit screen.

## Fill stitch settings

[Direction]	Specifies the embroidering direction. Select [Manual] to change to the desired direction of fill stitch.
[Density]	Specifies the stitch density of fill stitch.
[Pull compensation]	Specifies to correct the shrinkage of the pattern by slightly shortening or lengthening the stitching. Change the setting after you test embroider the pattern and can check the shrinkage.
[Under sewing]	Select if you need or do not need the under sewing for the stabilized fabric.

## Stippling stitch settings

[Run pitch]	Specifies the length of a stitch of the stippling stitch.
[Spacing]	Specifies the spacing between the stitches when embroidering the stippling stitch.
[Distance]	Specifies the offset from the pattern outline.
[Single/Triple stitch]	Specifies the stitch type.

## Decorative fill stitch settings

[Size]	Increases/reduces the size of the pattern.
[Direction]	Specifies the rotation angle of the pattern.
[Outline]	Select whether [ON] or [OFF]. The outline is also converted to embroidery data. If [ON] is selected, the number of thread jumps can be reduced.
[Random shift]	Randomly varies the line. If a setting of 1 or more is specified for [Random shift], a [Type] setting for the [Random shift] can be selected.
[Position offset]	Specifies the reference point for the pattern.
[Thickness]	Sets repeated or single stitching of the pattern.

1 Use to select the line or region to be changed.

→ Each touch of moves the highlighting of the selected pattern in order.

2 Select the setting to be changed, and then change the setting in the screen that appears. (In this example of a standard Fill stitch, the angle of the stitches will be changed.)



3 Touch [Manual], and then use to change the direction.

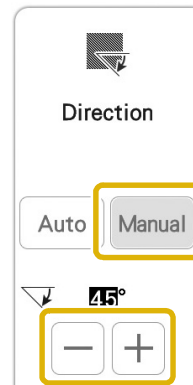

4 Touch to apply the setting.

\* Change other settings in the same way.

## Specifying Global Stitch Settings

The same stitch settings can be changed at the same time for multiple patterns of the same type.

- 1 Use to select the stitch whose settings are to be changed, and then touch .

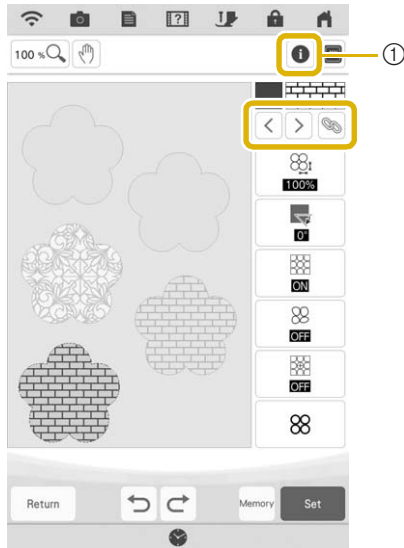

- 1 Touch to check various information such as the thread colors.  
→ The same stitch type areas will be selected at the same time.

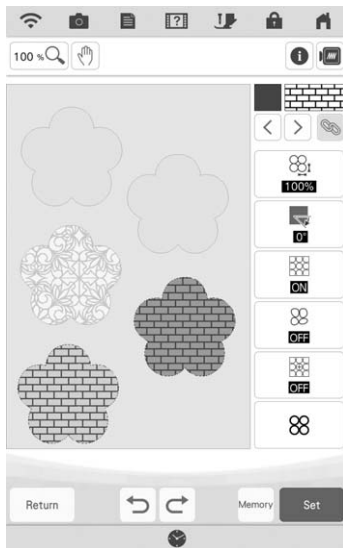

- 2 Follow steps 2 through 4 in “Specifying Individual Stitch Settings” on page 161 to change the settings.

- 3 Touch to convert work into an embroidery pattern and to display the embroidery edit screen.

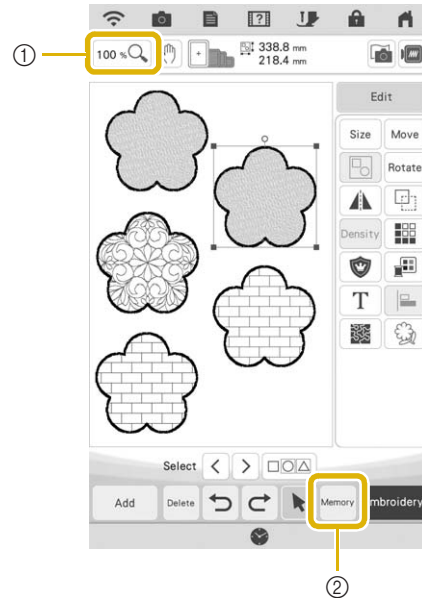

- 1 Touch to check an enlarged view of the pattern.
- 2 Touch to save the embroidery data.



# IQ DESIGNER WITH SCAN

## Create the pattern using scanned images or image data files

In addition to using built-in shapes and drawing tools, you can create patterns using scanned images of fabric, line drawings, illustrations, and data files of images.

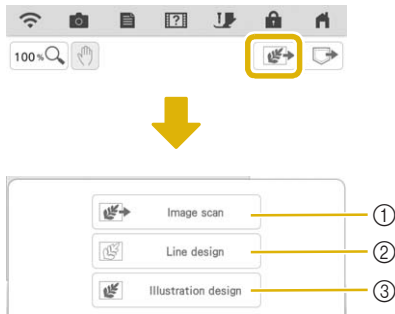

- ① Touch this key to use the image as a background image. (page 165)
- ② Touch this key to convert a line drawing to embroidery data. (page 169)
- ③ Touch this key to convert an illustration to embroidery data. (page 172)

## Using the Scanning Frame

### 1 Prepare the desired drawing/illustration.

### IMPORTANT

- If, during scanning, the embroidery foot comes into contact with the material to be scanned (illustration, etc.), the material to be scanned or embroidery foot may be damaged. Do not scan materials that may come into contact with the embroidery foot, such as thick materials or materials with wrinkles or creases.

#### Memo

- Only one sheet of paper can be placed in the scanning frame per scan.

### 2 Place the paper to be scanned in the scanning frame, and then secure the paper in place with the magnets.

- \* Place the magnets at six locations around the paper to secure it, making sure that the line drawing is not covered.

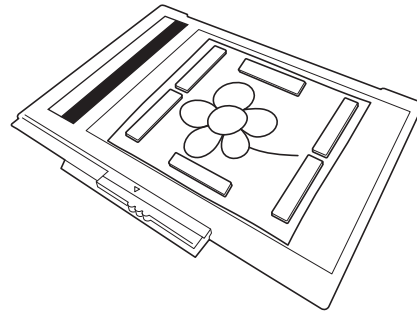

#### Note

- When placing the paper in the scanning frame, make sure that the white balance area is not hidden; otherwise, the drawing cannot be scanned correctly. At the same time, be sure to place the scan image within the scan area. The image out of the scan area will not be scanned.

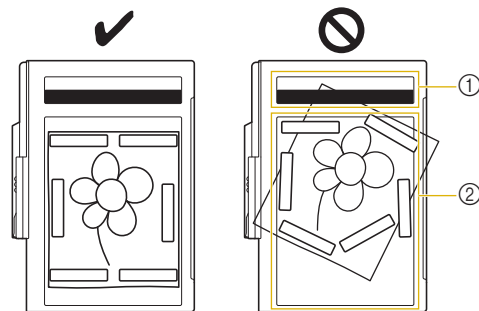

- ① White balance area
- ② Scan area

- Make sure that the white balance area or the scan area is not dirty or scratched; otherwise, the image cannot be scanned correctly.
- Be sure to use the magnets which are included with the scanning frame. If any other magnets are used, they may become attached to the machine during scanning, or other problems, such as a misaligned scan image, may occur.
- Be sure to place the magnets so that they secure the paper firmly. If the paper is placed unevenly, the image cannot be scanned correctly.
- If the scanning frame is dirty, gently wipe it with a soft cloth that has been soaked in lukewarm water then firmly wrung.

**Memo**

- If you want to scan an image from a small piece of paper that can't be held with the magnets, copy that image onto a larger piece of paper, to then be placed on the scanning frame.

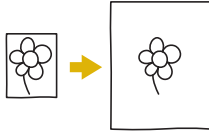
**3 Attach the embroidery unit to the machine, and then turn on the machine.**

- \* Refer to "ATTACHING THE EMBROIDERY UNIT" on page 13.

**Memo**

- Unthread the machine to avoid having the thread slipping out of the needle or getting caught on the embroidery frame.

**4 Press the "Presser Foot Lifter" button to raise the embroidery foot, and then press the "Needle Position" button to raise the needle.**

- \* The embroidery foot is not raised high enough when raised with the presser foot lever.

**IMPORTANT**

- Make sure that embroidery foot and needle are fully raised. If scanning is started with the embroidery foot and needle lowered, the scanning frame may hit the machine, causing damage.

**5 After attaching the scanning frame to the embroidery unit, swing the frame-securing lever toward you to secure the frame.**

- \* Refer to "ATTACHING THE EMBROIDERY FRAME" on page 32.

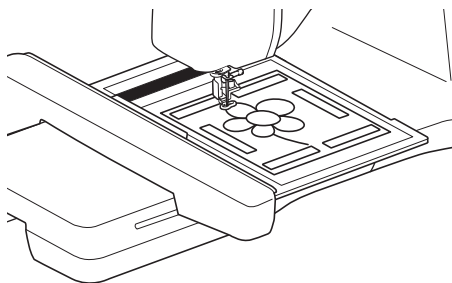
**Note**

- Be sure not to attach any embroidery foot other than the embroidery foot "W", otherwise the embroidery foot will be scanned.

**Scanning with an Embroidery Frame**

Drawings and illustrations can also be scanned using an embroidery frame. Hoop the embroidery frame with fabric larger than the frame. Place the paper to be scanned on the fabric, and then secure it with tape.

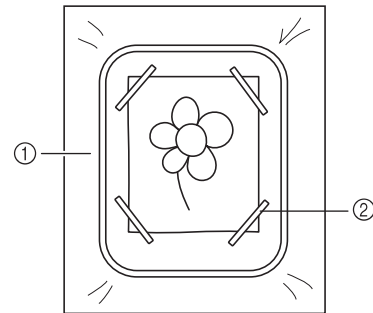

- ① Fabric
- ② Tape

**Scanning to Trace Background Image**

If you have a favorite picture or drawing, it can easily be traced as a scanned background image and you can create your own pattern.

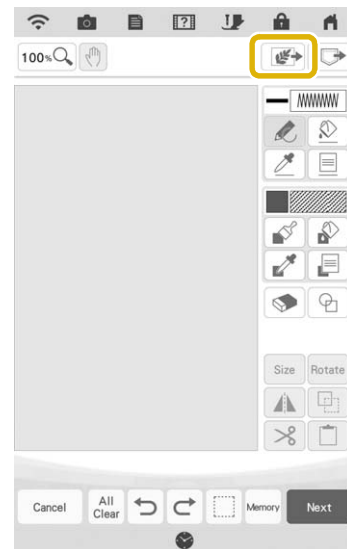
**1 Touch .**

**2** Touch  .



→ The image display screen appears.

**3** Using the magnets, affix a picture to the scanning frame and attach the frame to the machine. Refer to “Using the Scanning Frame” on page 164.

**4** Touch  .



To convert an image to a line or fill image, scan the design with the Scanning Frame so that your machine can retrieve appropriate color information.

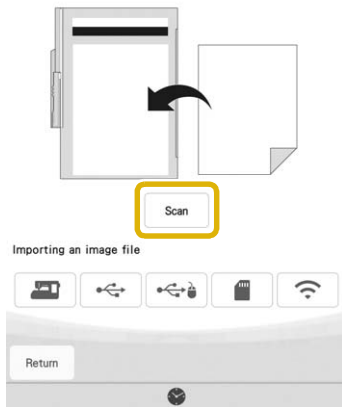

→ When the following message appears, touch  .



→ Scanning begins.

\* To stop scanning and return to the screen in step **4**, touch  .

 **Memo**

- The most recently scanned image is automatically stored in the machine’s memory. To import this saved image, touch  . (page 167)

**5** When scanning is finished, scanned image is displayed transparently in the pattern drawing area.





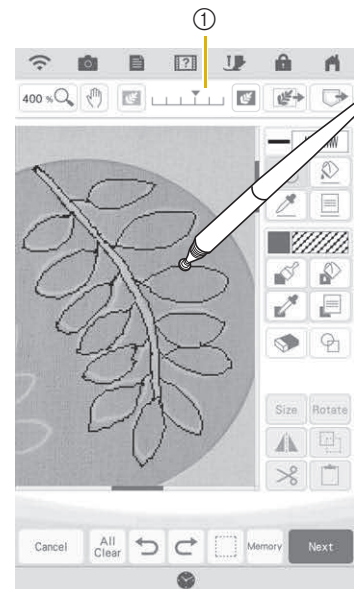

**6** Using the included fine tipped stylus pen or dual purpose stylus, touch  , and then draw lines to trace the image.

\* For details on drawing lines, refer to “Drawing Lines” on page 152.



① Transparency adjustment

\* Touch  or  to adjust the transparency of the background.

Each touch of  lightens the background, making the line pattern darker. Each touch of  darkens the background, making the line pattern lighter.

**7** After editing the pattern, touch  to specify the settings for pattern.

8 Touch **Set** to display the embroidery edit screen.

## Importing the Background Image

Prepare the data file of your favorite picture so that you can create an embroidery pattern. Save data as a .jpg, .bmp, or .png file type, on a USB media stick or SD card.

The most recently scanned image can also be recalled from the machine's memory.

In addition, images can be transferred from a smart device to the machine using the IQ Intuition-Positioning App. (page 188)

1 Touch .

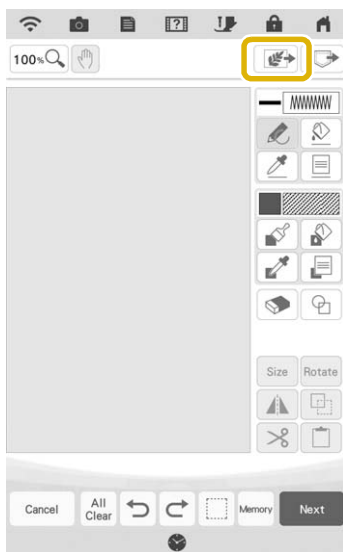

2 Touch  Image scan.



→ The image display screen appears.

3 Select the device you saved the data to.



### Memo

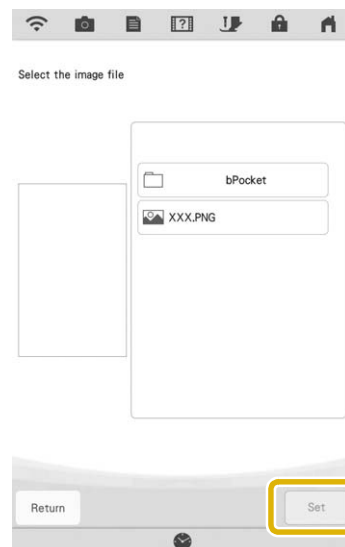

- For details on files that can be imported, refer to “SPECIFICATIONS” in the Instruction and Reference Guide (Sewing).
- Touch  to transfer an image that was saved on the smart device then sent to the machine. For details, refer to “Transferring an Image from a Smart Device to the Machine” on page 188.

4 Select the data, and then touch **Set**.

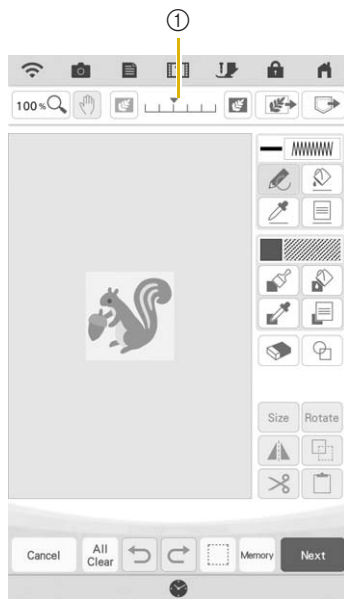

- 5** The selected image is displayed transparently in the pattern drawing area.



- \* Use gauge ① to adjust the transparency of the background. Each touch of  lightens the background, making the line pattern darker. Each touch of  darkens the background, making the line pattern lighter.

# LINE SCAN

Custom patterns can be created from drawings. You can create patterns by scanning your drawings using the included scanning frame or importing an image from USB media or SD card. In addition, images can be transferred from a smart device to the machine using the IQ Intuition-Positioning App. (page 188)

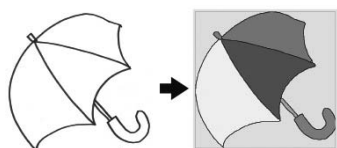

## Recommended line drawings for Line Scan

- Line drawings must be drawn clearly using lines with approximately 1 mm thickness.
- Line drawings should be drawn in a strong contrast.
- If the lines are too short or gathered too densely, they will not be scanned correctly.

### Memo

- For details on creating patterns using color illustrations, refer to “ILLUSTRATION SCAN” on page 172.
- If you cannot scan the drawings as expected, you can edit the design in IQ Designer. Refer to “PATTERN DRAWING SCREEN” on page 150.
- Line drawings are scanned without recognizing the thickness of lines. If you want to change the thickness of lines, specify in the settings screen. Refer to “STITCH SETTINGS SCREEN” on page 161.
- Complicated artwork should be converted using the “Scanning to Trace Background Image” method on page 165.

## Using the Scanning Frame to Create a Pattern with Line Scan

1 Touch .

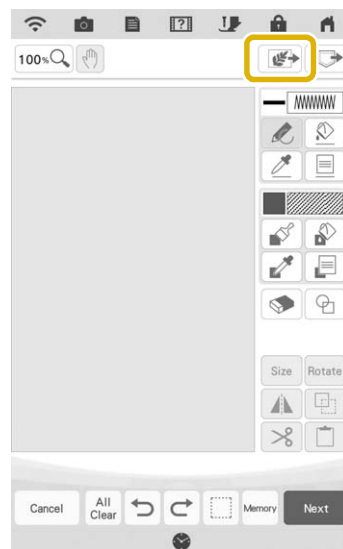



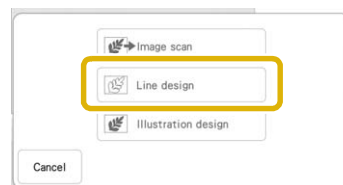

2 Touch  Line design.



- \* When the image has already been imported, continue with step 4.
- \* When the image has not been imported, continue with step 3.

**3 Touch**  .

- \* To import an image from USB media or SD card, touch ,  or  . For details, see “Importing the Background Image” on page 167.
- \* Touch  to transfer an image that was saved on the smart device and sent to the machine. For details, refer to “Transferring an Image from a Smart Device to the Machine” on page 188.
- \* If you scan the image, make sure that the scanning frame is attached to the machine. Refer to “Using the Scanning Frame” on page 164.

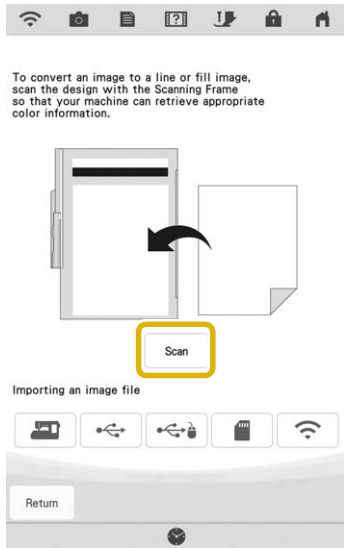

**Memo**

- The scanned background image can be converted to line scan data. At this time, it is unnecessary to scan the line drawing again.
- For details on files that can be imported, refer to “SPECIFICATIONS” in the Instruction and Reference Guide (Sewing).

→ When the following message appears, touch  .

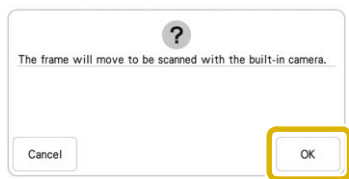

→ Scanning begins. Line drawings are scanned as black lines.

- \* To stop scanning and return to the screen in step **3**, touch  .

**Memo**

- The most recently scanned image is automatically stored in the machine’s memory. To import this saved image, touch  . (page 167)

**4 When scanning is finished, specify the [Gray-Scale Detection level] on the screen if necessary.**

The [Gray-Scale Detection level] can change the black and white threshold for the image.

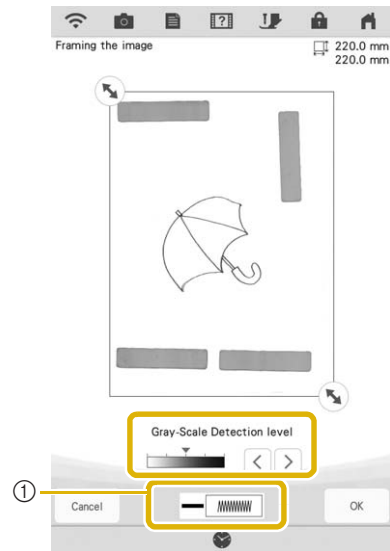

① Changes the line color and stitch type. (page 153)

- \* If you do not know how the settings should be changed, first continue the operation without specifying settings and check the results.
- \* To stop scanning and return to the screen in step **3**, touch  .

**5 Move**  **to frame the image for the pattern.**







**6 Touch**  .

→ The screen for confirming the converted image appears.

**7 In the screen for confirming the converted image, you can adjust the [Gray-Scale Detection level], the line color and stitch type again, if necessary.**







- \* If you do not know how the settings should be changed, first continue the operation without specifying settings and check the results.
  - \* To enlarge the image, touch .
  - \* To display the image before being converted, touch . Compare the images before and after being converted, and then change the settings if necessary.
  - \* To return to the previous screen, touch .
- After changes to the settings described above have been applied,  changes to . Touch  to check that the image is as desired.

## 8 Touch .

→ The pattern drawing screen is displayed.

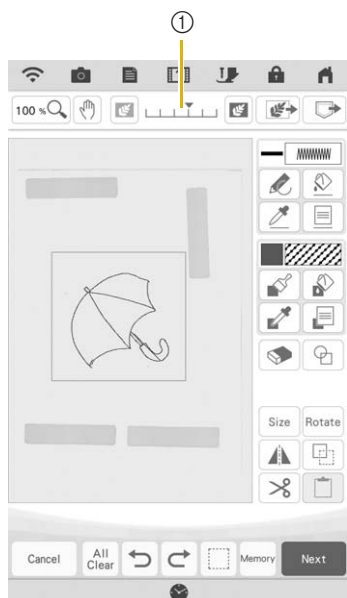
## 9 If necessary, edit the scanned image.



- \* After the scanned image is converted to stitching, it appears as a background in the pattern drawing screen. Use gauge ① to adjust the transparency of the background. Each touch of  lightens the background, making the line pattern darker. Each touch of  darkens the background, making the line pattern lighter.

### Memo

- Small dots or unwanted lines can be erased with the erase key.

# ILLUSTRATION SCAN

Custom patterns can be created from color illustrations. You can create patterns by scanning an illustration using the included scanning frame or importing an image from USB media or SD card.

In addition, images can be transferred from a smart device to the machine using the IQ Intuition-Positioning App. (page 188)

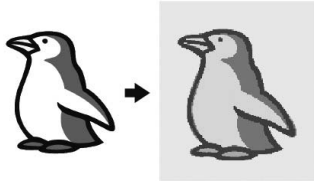

## Recommended illustrations for Illustration Scan

- Patterns that are clearly drawn, with no gradation, fading or blurriness.
- Patterns that are at least a 5 mm square
- Patterns that are extremely simple images

### Memo

- Complicated artwork should be converted using the “Scanning to Trace Background Image” method on page 165.

## Using the Scanning Frame to Create a Pattern with Illustration Scan

1 Touch .

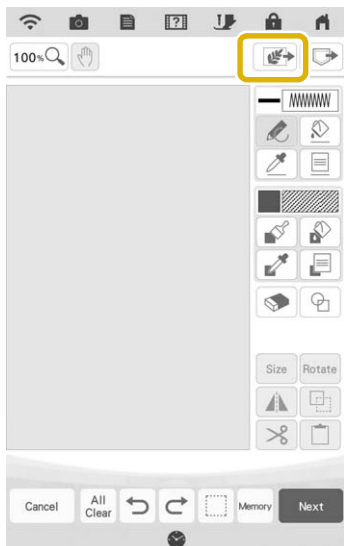

2 Touch .

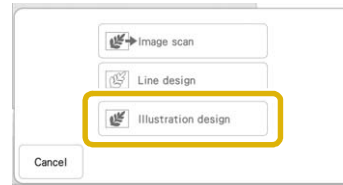

- \* When the image has already been imported, continue with step 4.
- \* When the image has not been imported, continue with step 3.

3 Touch .

- \* To import an image from USB media or SD card, touch , or .
- \* Touch to transfer an image that was saved on the smart device and sent to the machine. For details, refer to “Transferring an Image from a Smart Device to the Machine” on page 188.



To convert an image to a line or fill image, scan the design with the Scanning Frame so that your machine can retrieve appropriate color information.

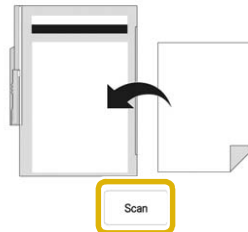

Importing an image file



→ When the following message appears, touch .



- Scanning begins.
- \* To stop scanning and return to the screen in step 3, touch .

### Memo

- The most recently scanned image is automatically stored in the machine's memory. To import this saved image, touch . (page 167)

## 4 When scanning is finished, specify the necessary settings in the scan image confirmation screen.

Change the settings to adjust the image so it can easily be converted to the desired pattern.

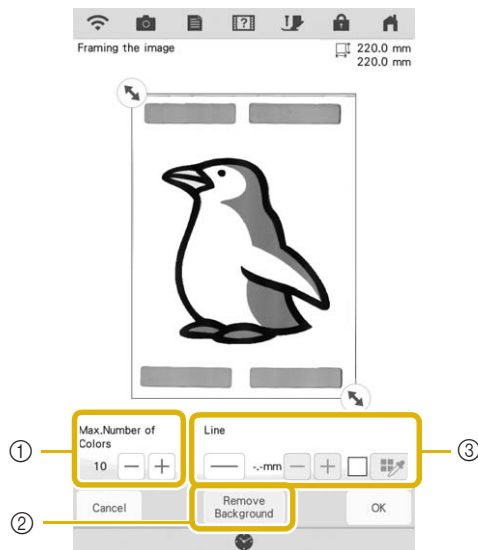



①	[Max. Number of Colors]	The number of colors in an image will be reduced less than the number specified here, and then the outline will be extracted.
②	[Remove Background]	Select whether or not the background color will be included as one of the colors.
③	[Line]	Select whether or not the outline will be detected as a line. A thick outline can also be detected as a region. When detected as a line, the line thickness and color can be specified.

- \* To stop scanning and return to the screen in step ③, touch .

### Memo

- Touch  to detect the outline. Line thickness can be specified from 1.0 mm (1/16 inch) to 5.0 mm (3/16 inch).



- Touch  to select the outline color. Select by touching the color, or moving  icon

using  in the color selection screen.





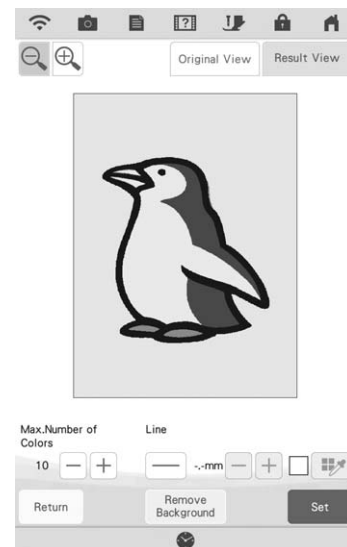

## 5 Move to frame the image for the pattern.

## 6 Touch .

→ The screen for confirming the converted image appears.

## 7 In the screen for confirming the converted image, adjust the image as necessary as in step ④.





- \* To enlarge the image, touch .
  - \* To display the image before being converted, touch . Compare the images before and after being converted, and then change the settings if necessary.
  - \* To return to the previous screen, touch .
- After changes to the settings described above have been applied,  changes to . Touch  to check that the image is as desired.

## 8 Touch .

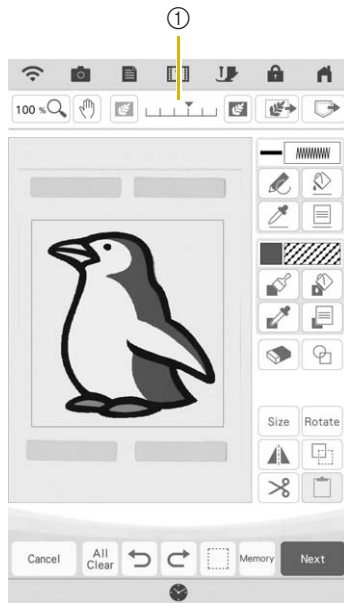
→ The pattern drawing screen is displayed.

**9** If necessary, edit the scanned image.

- \* After the scanned image is converted to stitching, it appears as a background in the pattern drawing screen. Use gauge ① to adjust the transparency of the background. Each touch of  lightens the background, making the illustration pattern darker. Each touch of  darkens the background, making the illustration pattern lighter.

# STIPLING

## Basic Stippling with IQ Designer

Create a stippling design with the basic procedure. Example:



1 Touch .

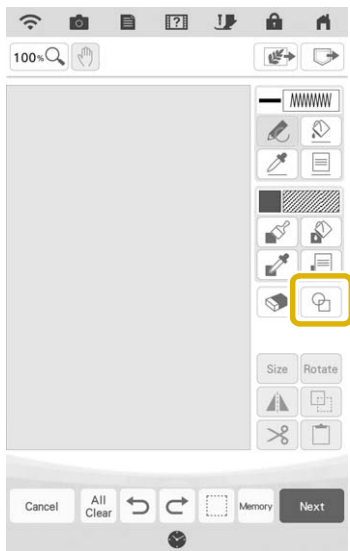

2 Select the square shape, and then touch .

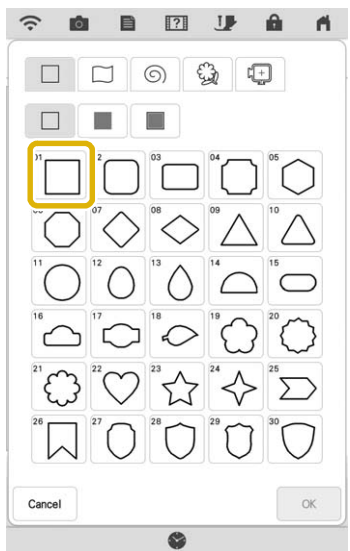

3 Touch .

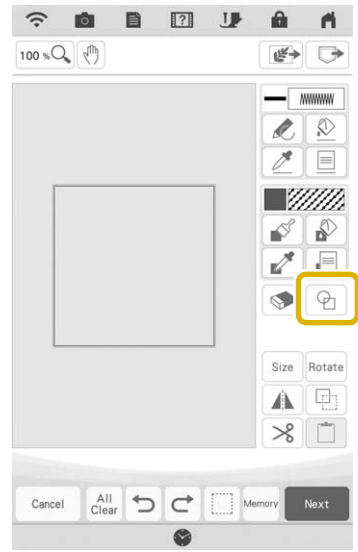

4 Select the heart shape, and then touch .

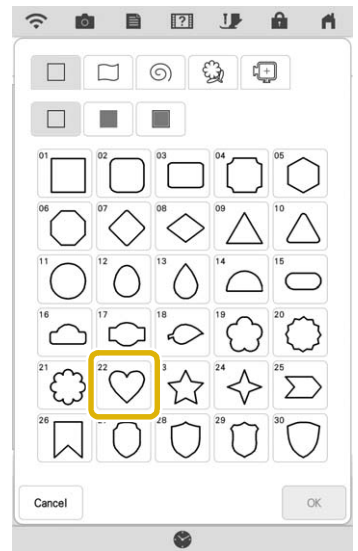



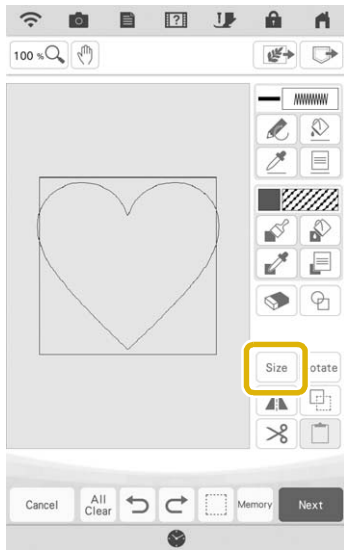

4

IQ Designer



5 Touch  .

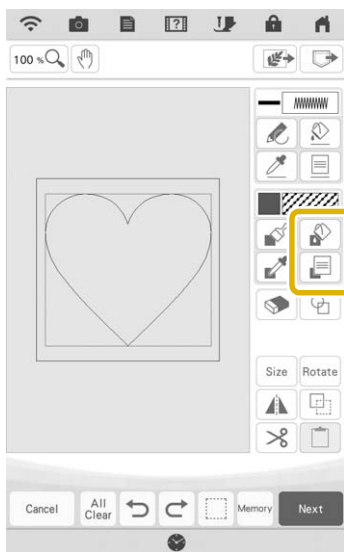

6 Touch  until the heart shape fits in the square shape, and then touch  .

7 Touch  , and then touch  .



8 Touch  , and then select the stitch color.  
Touch  after setting the color.

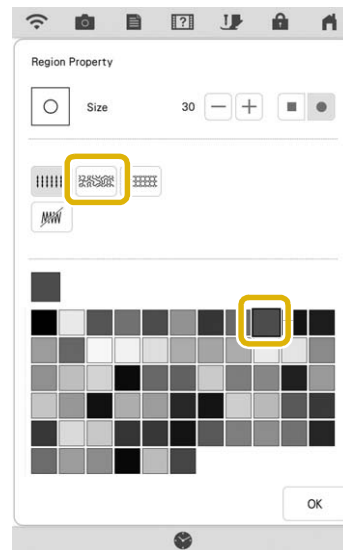

9 Select the area you want to set stippling effect.

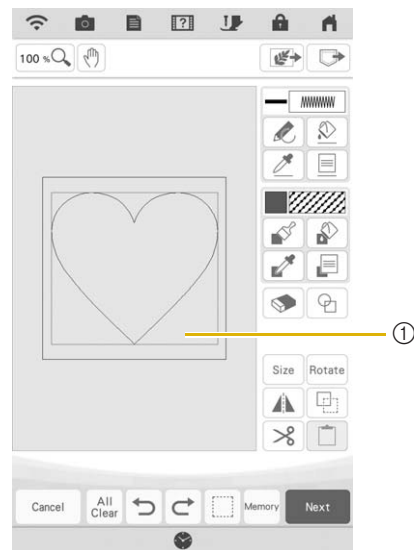

① Select this area.

**10** Touch **Next**.

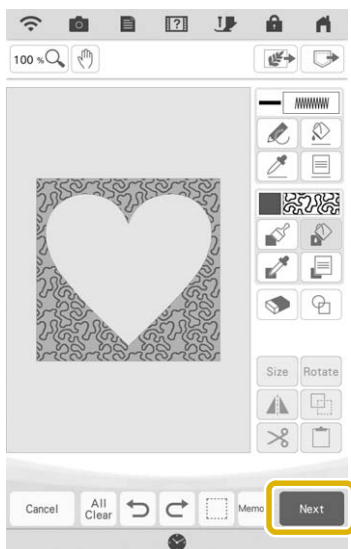

**11** Adjust the stippling settings to create the desired effect, and then touch **Set**.

\* For details, refer to “Specifying Individual Stitch Settings” on page 161.

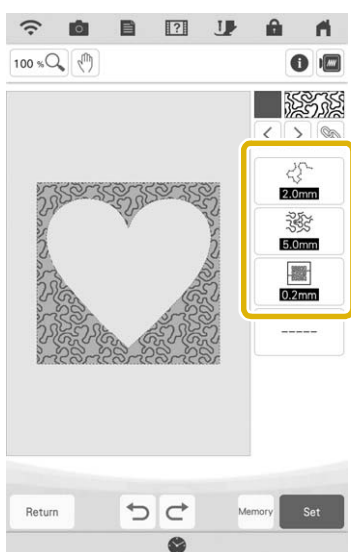

**12** Follow the procedure described on “Editing Patterns” on page 35 to edit the pattern as desired.

## Scanning Drawing to Create Stippling Pattern

Create a custom pattern with stippling design.  
**Example:**

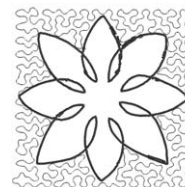

**1** Place a drawing of your design on the scanning frame.

**2** Touch .

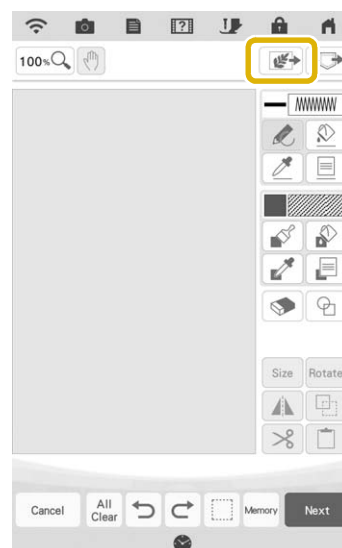

**3** Touch  **Line design**.

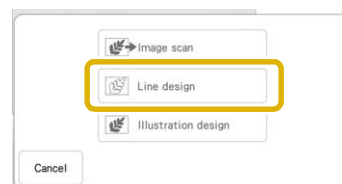

- \* When the image has already been imported, continue with step **5**.
- \* When the image has not been imported, continue with step **4**.



**4** Position the scanning frame on the machine, and then touch **Scan** .

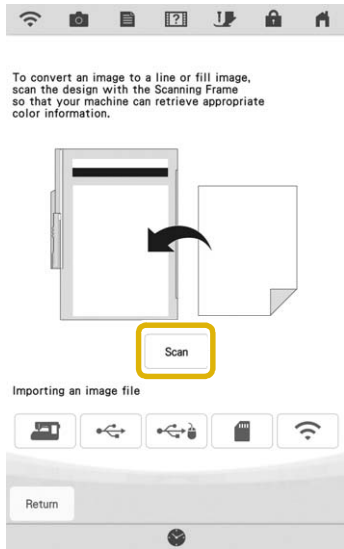

**Memo**

- For details on files that can be imported, refer to “SPECIFICATIONS” in the Instruction and Reference Guide (Sewing).

→ When the following message appears, touch **OK** .

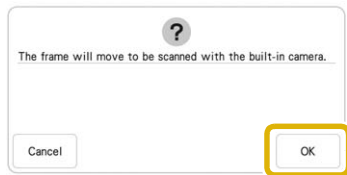

→ Scanning begins.

- \* To stop scanning and return to the screen in step **4**, touch **Cancel** .

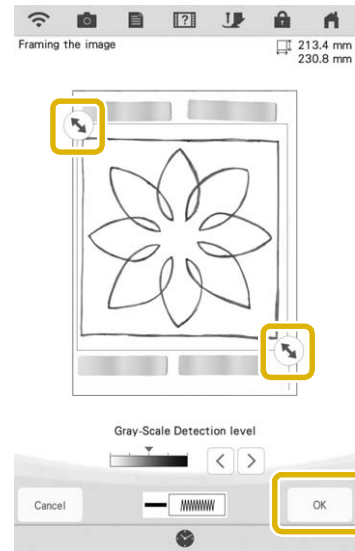

**5** When scanning is finished, move to frame the image for the pattern, and then touch **OK** .



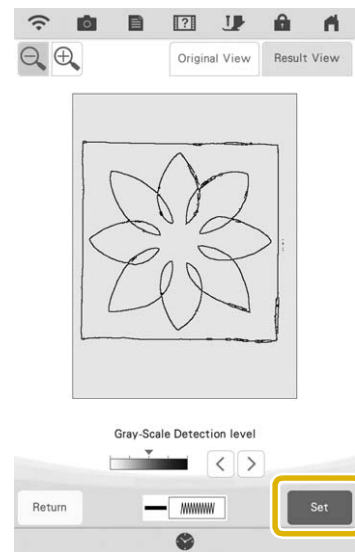

**6** The screen for confirming the converted image appears, adjust the image if necessary and then touch **Set** .

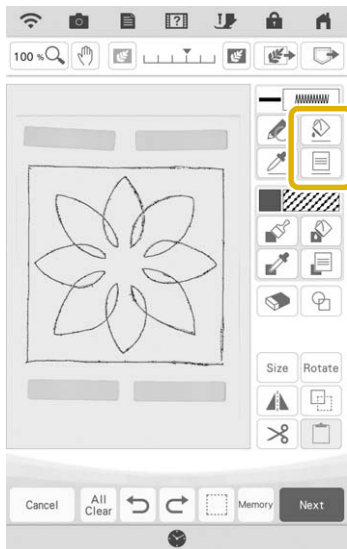

→ The pattern drawing screen is displayed.

- 7 To set the outline of the pattern, touch , and then .



- 8 Touch  and then . This will set the outline without a stitch.

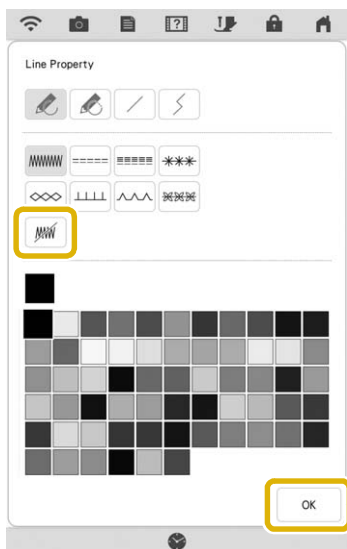

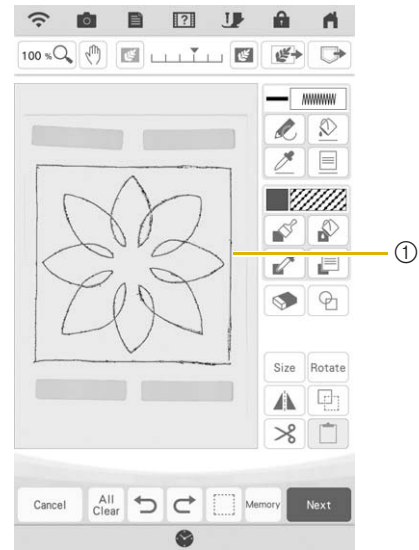

- 9 Select the outline of the pattern.

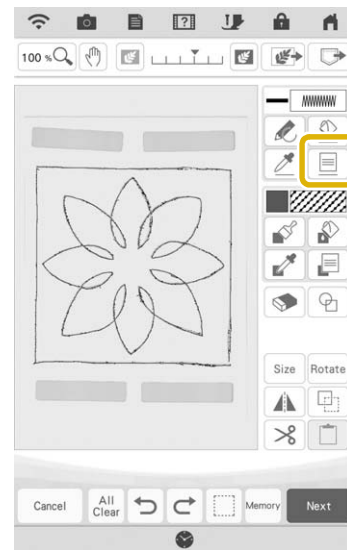

① Outline of the pattern

- 10 Touch .



- 11 Touch  and select the stitch color, and then touch .

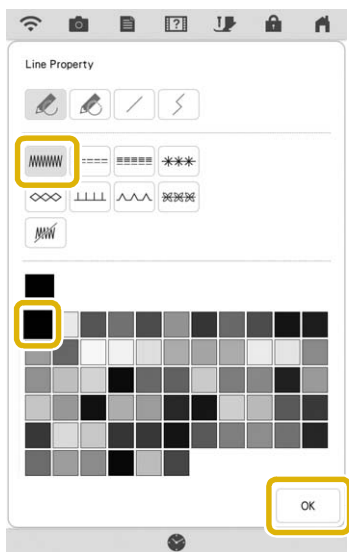

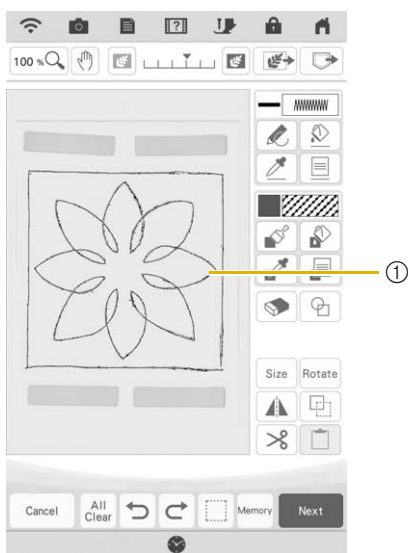

- 12 Select the stitch line.

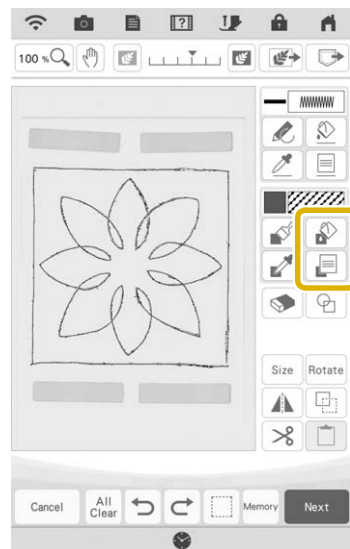

① Stitch line

- 13 To set the stippling stitch color and fill stitch type, touch , and then .



- 14 Touch , and then select the stitch color. Touch  after setting the color.

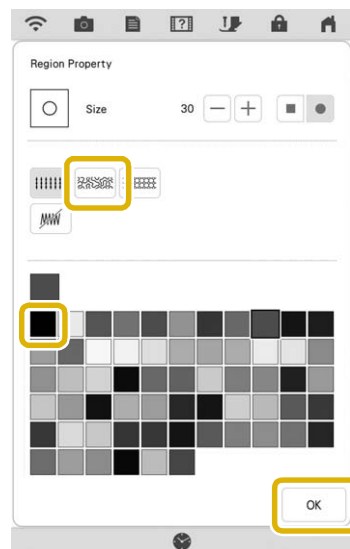

- 15** Select the area you want to set stippling effect.

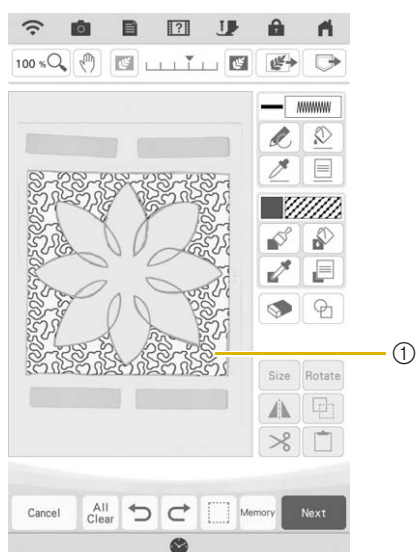

① Area where stippling is applied

- 16** Follow the procedure from step **10** of “Basic Stippling with IQ Designer” on page 175.

## Scanning Fabric and Stippling

Use the fabric pattern to coordinate with the stippling pattern.

- 1** Hoop the fabric in the embroidery frame.
- 2** Touch .

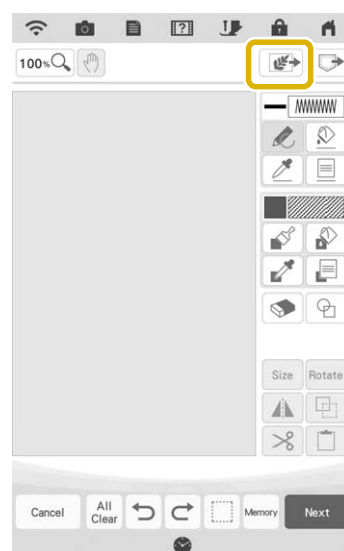

- 3** Touch  Image scan .

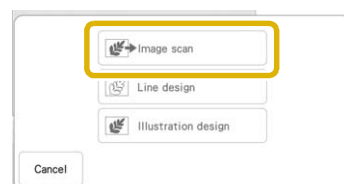

→ The image display screen appears.

**4** Position the embroidery frame on the machine, and then touch **Scan**.

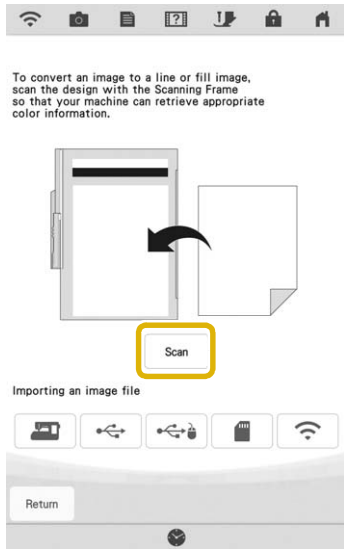

**Memo**

- Although the instructions in the LCD screen refer to the scanning frame, this example uses an embroidery frame for scanning.
- For details on files that can be imported, refer to “SPECIFICATIONS” in the Instruction and Reference Guide (Sewing).

→ When the following message appears, touch **OK**.

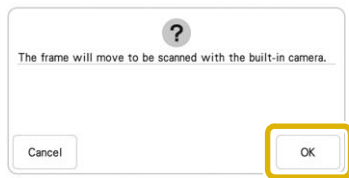

→ Scanning begins.

- \* To stop scanning and return to the screen in step **4**, touch **Cancel**.

**5** Touch **Stamp**.



**Memo**

- This fabric sample has circular shapes that can be easily matched with a built-in stamp. For more complex or irregular designs, you can use the line drawing tools to match the designs in the fabric.

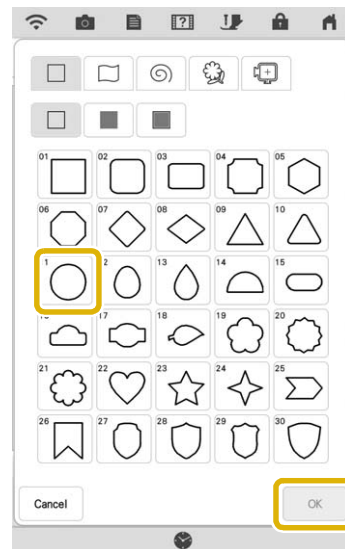

**6** Select the circle shape, and then touch **OK**.

**OK**.



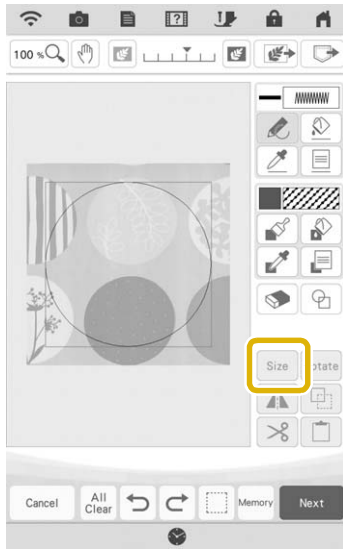

7 Touch  .



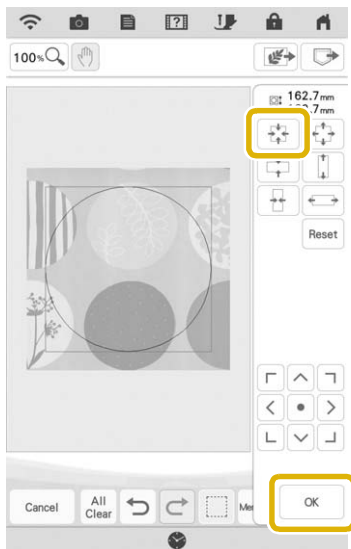

8 Touch  until the size of circle fits the pattern on the fabric, and then touch  .

\* Use  to align the position of the circle to the pattern on the fabric.

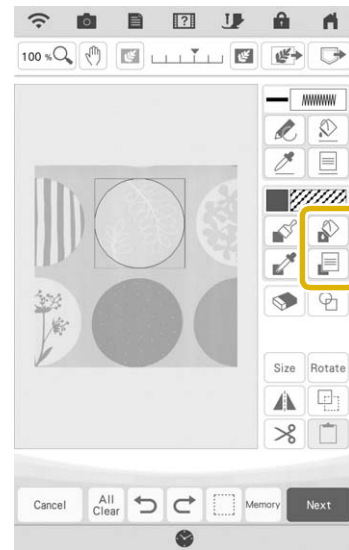

9 To set the stitch color and fill stitch type, touch  , and then  .



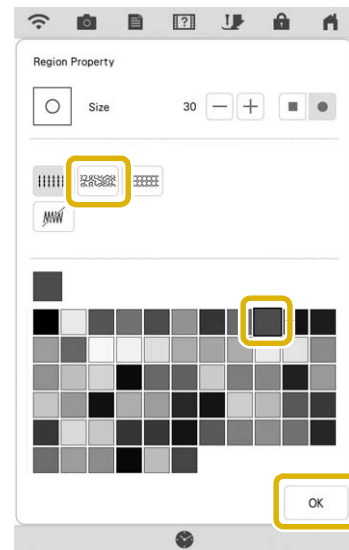

10 Touch  , and then select the stitch color. Touch  after setting the color.





4

**11** Select the area you want to set stippling effect.

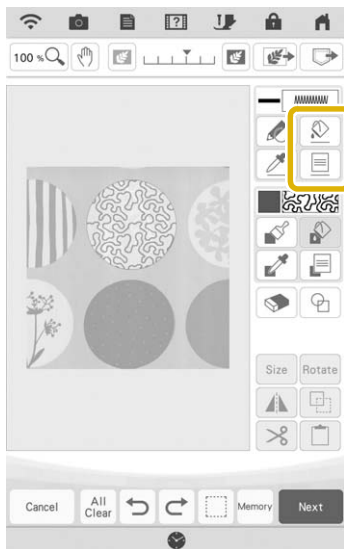

**12** To set the outline of the pattern, touch , and then .



**13** Touch  and then . This will set the outline without a stitch.

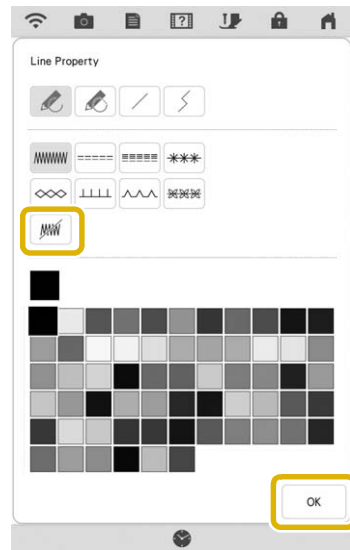

**14** Select the outline of the pattern.

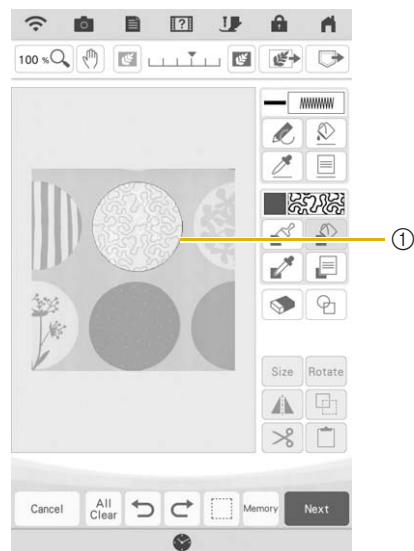

① Outline of the pattern

**15** Follow the procedure from step **10** of “Basic Stippling with IQ Designer” on page 175.

→ Start embroidering on the fabric that you scanned at first.





## Decorative Stitching Around a Pattern in Embroidery (a Quilting Function)

### Memo

- For best results, reduce the embroidery speed.
- For best results, hoop the stabilizer and fabric and embroider the design prior to adding the batting and backing under the hoop for quilting.

Stippling can be added around an Embroidery pattern.

- 1 Touch  and select the pattern that decorative stitching will be added around, and then touch  in the embroidery edit screen.

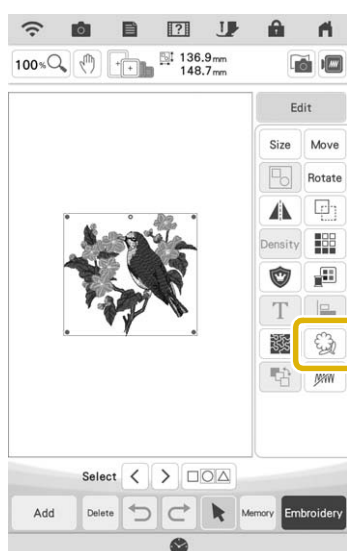

→ The outline of the pattern is displayed.

- 2 Touch .

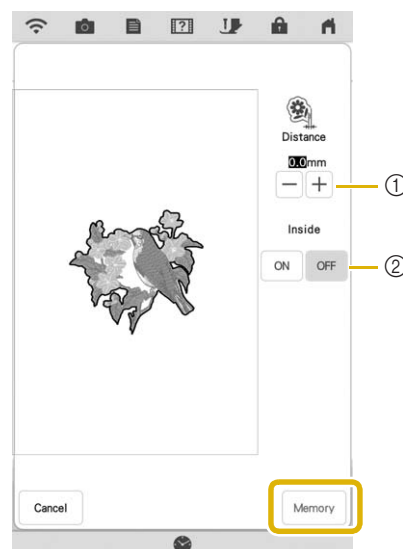

- ① Specify the distance from the outline of the pattern to the pattern.
  - ② When set to [ON], lines inside the pattern are also extracted.
- A message appears, and the pattern outline is registered as a stamp shape in IQ Designer. Touch

.



- 3 Touch  to continue to the embroidery screen, and then embroider the pattern.
- 4 Keeping the fabric in the hoop, place batting and backing under the fabric in the hoop, being careful to avoid placing any pins or tape in the embroidery area.

### Memo

- If desired, remove the embroidered fabric from the frame, layer with batting and backing, then secure the three layers together in the frame.

- 5 Touch  in the home page screen to start IQ Designer.

- 6 Touch  to scan the embroidered fabric. Refer to "Importing the Background Image" on page 167 for details.



- 7 Touch , touch  to recall the stamp shape registered in step 2, and then arrange it over the scanned pattern.

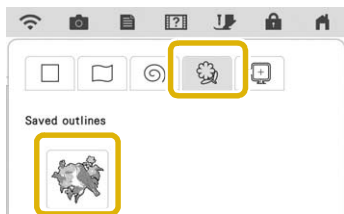
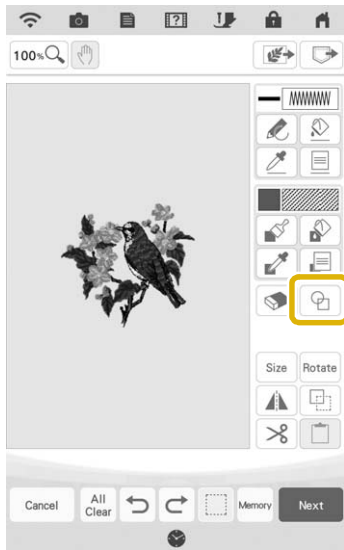

- 8 Touch  to use a stamp or rectangular frame to determine the area to be stitched.

**Memo**

- If the area is to be drawn by hand, be sure to draw a completely closed shape. If the area is not closed, it cannot be correctly filled with the decorative stitching.

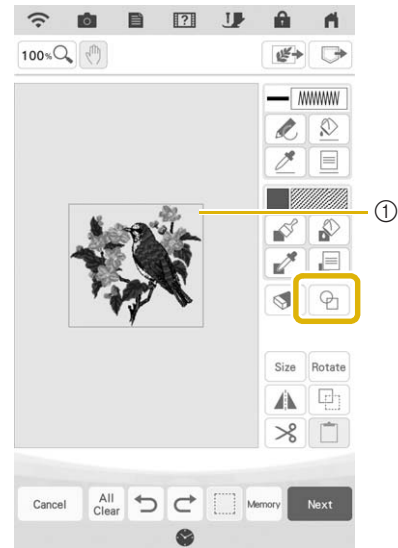

① Stamp or rectangular frame

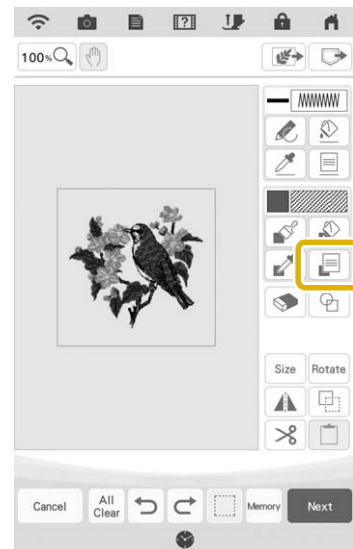

- 9 Touch  to select the pattern and color of the decorative stitching.

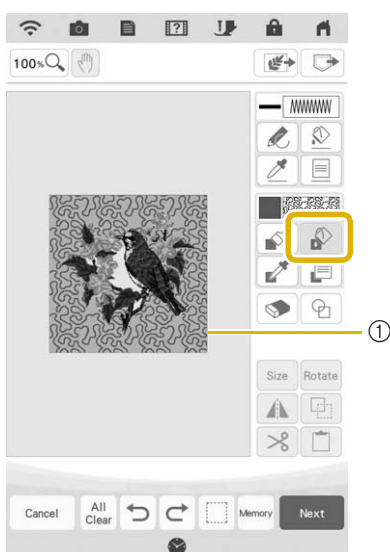

**10** Touch , and then fill the area to be stitched outside of the stamp shape outline.



① Fill the area.

**11** If you select the stamp shapes to determine the area on step **8**, touch  for the line tool keys to select . Touch , then select the frame outline.

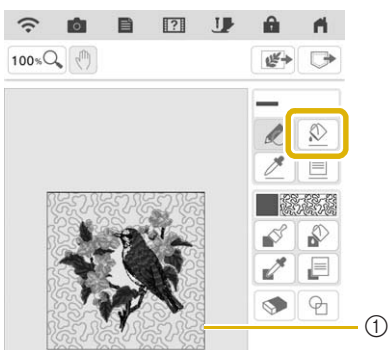
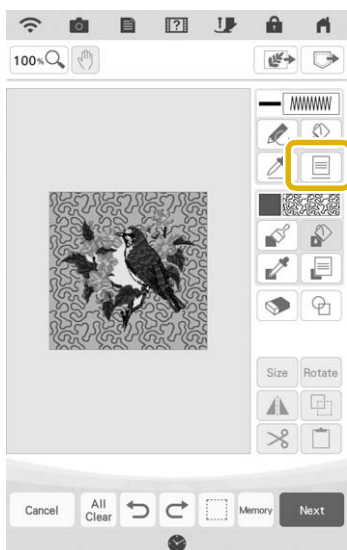

① Stamp outline

**12** Touch .

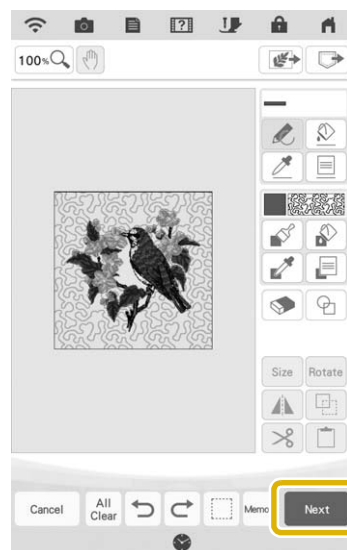

**13** Specify the stitch settings in the stitch settings screen, and then touch .

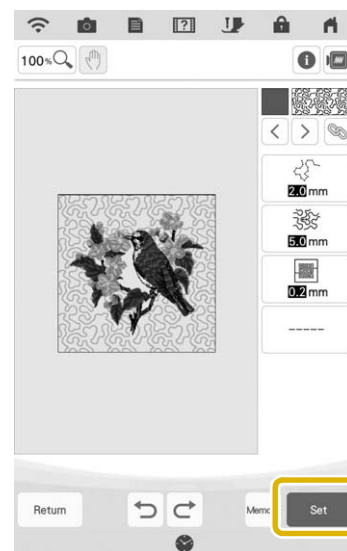

**14** Embroider the decorative stitching around the embroidery pattern.

# IQ INTUITION- POSITIONING APP

Images saved on a smart device can be transferred to the machine so that an embroidery pattern can be created in IQ Designer.

## ■ Installing the IQ Intuition- Positioning App

- 1 Use your smart device to scan the appropriate QR code below to visit Google Play™ for Android devices or the App Store for Apple devices.



Android™:  
[https://www.babylock.com/IQIntuition\\_PositioningAndroid](https://www.babylock.com/IQIntuition_PositioningAndroid)



iOS:  
[https://www.babylock.com/IQIntuition\\_PositioningiOS](https://www.babylock.com/IQIntuition_PositioningiOS)

- 2 Install [IQ Intuition- Positioning].



IQ Intuition- Positioning

### 📝 Memo

- To download and install the app, you can also search for [IQ Intuition- Positioning] in Google Play or the App Store.
- Visit the following web site for support information on the app.  
<https://www.babylock.com/support>

## ■ Transferring an Image from a Smart Device to the Machine

### 📝 Memo

- The app will be updated from time to time. The following descriptions may differ from the actual screens and operations.

- 1 **Connect the machine to your wireless network.**
  - \* Refer to "WIRELESS NETWORK CONNECTION FUNCTIONS" in the machine's Instruction and Reference Guide (Sewing).
- 2 **Confirm that your smart device and your machine are connected to the same network.**
- 3 **Tap the icon on the smart device for [IQ Intuition- Positioning] to start the app.**
- 4 **Follow the instructions that appear in the app to connect the app to your machine.**
  - \* Select the name that appears beside [Machine name] in the settings screen on your machine.

**5** Tap 

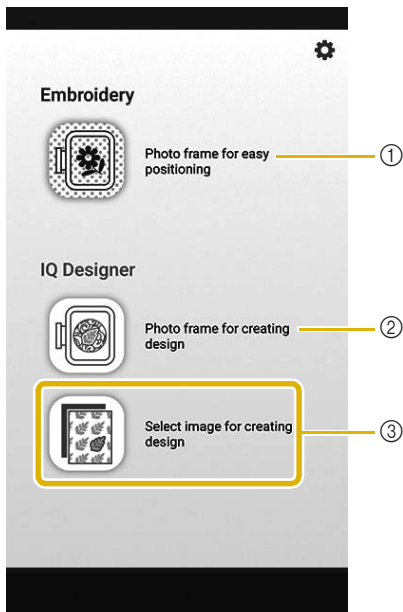

- ① This icon is not available for your machine. It is for machines that are not equipped with a camera. Your machine will use the built-in camera to align embroidery patterns. For details, refer to “Display the Fabric while Aligning the Embroidering Position” on page 86.
- ② This icon is not available for your machine. It is for machines that are not equipped with a camera. Your machine will use the built-in camera to create embroidery patterns in IQ Designer. For details, refer to “IQ DESIGNER WITH SCAN” on page 164.
- ③ This icon allows you to transfer an image from the smart device to the machine to create a design in IQ Designer.

**6** Select the image, then select [Send to the Machine] to transfer it from the smart device to the machine.

→ You will receive confirmation in the app that the image was successfully sent to IQ Designer.

**7** Start IQ Designer on the machine, and then touch .



**8** Touch the appropriate key for the image to be used.





- ① Touch this key to use the image as a background image. For details, refer to “Scanning to Trace Background Image” on page 165.
- ② Touch this key to convert a line drawing to embroidery data. For details, refer to “LINE SCAN” on page 169.
- ③ Touch this key to convert an illustration to embroidery data. For details, refer to “ILLUSTRATION SCAN” on page 172.

**9** Touch .

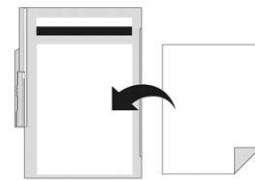

To convert an image to a line or fill image, scan the design with the Scanning Frame so that your machine can retrieve appropriate color information.



**10** Select the data, and then touch .

 **Memo**

- Touch  to delete the selected data.

**11** Proceed through the appropriate steps in IQ Designer to finish creating the embroidery pattern.





Chapter **5**  
**Appendix**





## TROUBLESHOOTING

If the machine stops operating correctly, check the following possible problems before requesting service.

You can solve most problems by yourself. Visit us at "[www.babylock.com](http://www.babylock.com)".

If the problem persists, contact your authorized Baby Lock retailer.

### If the Thread Becomes Tangled Under the Bobbin Winder Seat

If the bobbin winding starts when the thread is not passed through the pretension disk correctly, the thread may become tangled beneath the bobbin winder seat.

Wind off the thread according to the following procedure.

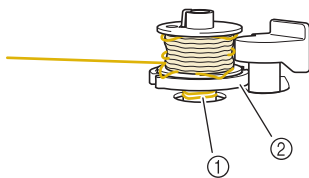

- ① Thread
- ② Bobbin winder seat

### ⚠ CAUTION

- Do not remove the bobbin winder seat even if the thread becomes tangled under the bobbin winder seat. The cutter in the bobbin winder seat may cause injury.

- 1 Touch  once to stop the bobbin winding.

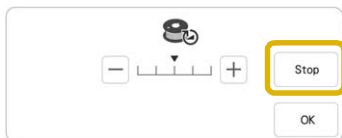

- 2 Cut the thread with scissors near the pretension disk.

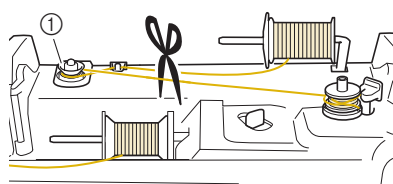

- ① Pretension disk



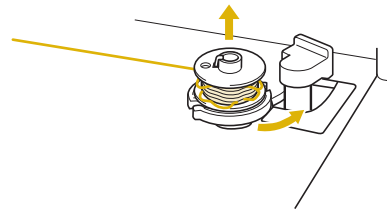

- 3 Push the bobbin winder switch to the right, and then remove the bobbin from the shaft and cut the thread leading to the bobbin in order to be able to completely remove the bobbin from shaft.

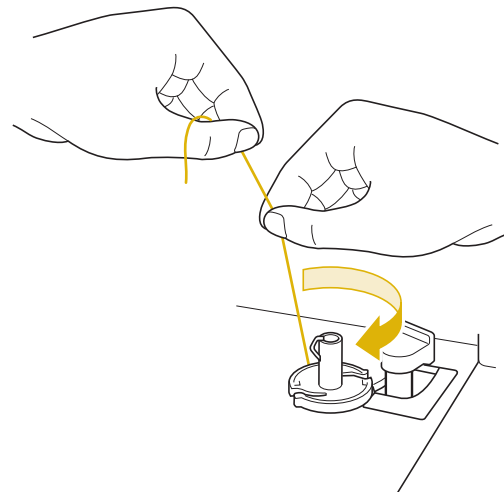





- 4 Hold the thread end with your left hand, and wind off the thread clockwise from under the bobbin winder seat with your right hand as shown below.



## List of Symptoms

If you have a minor problem with your machine, check the following solutions. If the solutions suggested do not correct the problem, contact your authorized Baby Lock retailer. Touch  →  Operation Guide →  for advice about minor embroidering problems during embroidering. Touch  at any time to return to the original screen.

### ■ Getting Ready

Problem	Cause	Solution	Page
Cannot thread the needle.	Needle is not in the correct position.	Press the “Needle Position” button to raise the needle.	—
	Needle is installed incorrectly.	Reinstall the needle correctly.	11
	Needle is turned, bent or the point is dull.	Replace the needle.	11
	Upper threading is incorrect.	Check the steps for threading the machine and rethread the machine.	21
	The needle threader hook is bent and does not pass through the eye of the needle.	Contact your authorized Baby Lock retailer.	—
	The needle threader lever cannot be moved or returned to its original position.	Contact your authorized Baby Lock retailer.	—
	A size 65/9 needle is being used.	The needle is incompatible with the needle threader. Manually pass the thread through the eye of the needle.	23
Cannot lower the embroidery foot with the presser foot lever.	Embroidery foot was raised using the “Presser Foot Lifter” button.	Press the “Presser Foot Lifter” button to lower the embroidery foot.	—
Bobbin thread does not wind neatly on the bobbin.	The thread is not passed through the bobbin winding thread guide correctly.	Correctly pass the thread through the bobbin winding thread guide.	16
	Bobbin spins slowly.	Touch  in the bobbin winding window to increase the bobbin winding speed.	17
	The thread that was pulled out was not wound onto the bobbin correctly.	Wind the thread that was pulled off around the bobbin 5 or 6 times clockwise.	16
	The empty bobbin was not set on the pin properly.	Set the empty bobbin on the pin and slowly turn the bobbin until you hear it click in place.	15
While winding the bobbin, the bobbin thread was wound below the bobbin winder seat.	You did not wind the bobbin thread properly when you initially wound the bobbin, or the bobbin thread was not properly set in the guides.	After removing the thread wound below the bobbin winder seat, wind the bobbin correctly. Follow the drawn images on the top of the machine for guidance when threading the machine for bobbin winding.	192
The bobbin thread cannot be pulled up.	Needle is turned, bent or the point is dull.	Replace the needle.	11
	Bobbin is set incorrectly.	Reset the bobbin thread correctly.	19
Machine does not operate.	All keys and buttons have been locked by  .	Touch  to unlock all keys and buttons.	9, 11
Nothing appears in the LCD.	Main power switch is not turned on.	Turn the main power to ON.	—
	The plug of the power cord is not inserted into an electrical outlet.	Insert the plug of the power cord into an electrical outlet.	—
The LCD screen does not look very clear.	The brightness of the screen is not adjusted.	Adjust the [Screen Display Brightness] in the settings screen.	—
Nothing happens, even if the LCD display is touched.	The screen has been locked.	Touch either of the following keys to unlock the screen.  	—
The LCD screen is fogged up.	Condensation has formed on the LCD screen.	After a while, the cloudiness will disappear.	—
Embroidery unit does not operate.	Embroidery unit is not attached correctly.	Reattach the embroidery unit correctly.	13
	Embroidery frame was attached before the unit was initialized.	Remove the embroidery frame, and then perform the initialization process correctly.	13

Problem	Cause	Solution	Page
Pointer of the projector does not indicate the position correctly.	With thick elastic fabric, the position will be misaligned only at raised parts in the fabric.	Manually adjust the position according to the thickness of the fabric.	43
	With fabric having a very uneven surface, the position is not correctly aligned.	The pointer indication should be used only as a reference.	—

## ■ While Embroidering

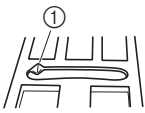
Problem	Cause	Solution	Page
Machine does not operate.	“Start/Stop” button was not pressed.	Press the “Start/Stop” button.	—
	There is no pattern selected.	Select a pattern.	40
	Embroidery foot is not lowered.	Lower the embroidery foot.	—
Needle breaks.	Needle is installed incorrectly.	Reinstall the needle correctly.	11
	Needle clamp screw is not tightened.	Tighten the needle clamp screw.	11
	Needle is turned or bent.	Replace the needle.	11
	Using improper needle or thread for the selected fabric.	Check the needle and fabric combination.	11, 49
	Wrong embroidery foot was used.	Use the recommended embroidery foot.	10
	Upper thread tension is too tight.	Adjust the thread tension.	92
	Fabric is pulled during embroidering.	Do not pull the fabric during embroidering.	—
	Spool cap is set incorrectly.	Check the method for attaching the spool cap, then reattach the spool cap.	21
	There are scratches around the opening in the needle plate. * There is a notch on the left side of the opening in the needle plate. This is not a scratch.	Replace the needle plate, or consult your authorized Baby Lock retailer.	—
	 ① Notch		
	There are scratches around the opening in the embroidery foot.	Replace the embroidery foot, or consult your authorized Baby Lock retailer.	9
	There are scratches on the bobbin case.	Replace the bobbin case, or consult your authorized Baby Lock retailer.	—
	Needle is defective.	Replace the needle.	11
	A bobbin designed specifically for this machine is not used.	Use a bobbin designed specifically for this machine.	15
	Upper threading is incorrect.	Check the steps for threading the machine and rethread the machine.	21
	Bobbin is set incorrectly.	Reset the bobbin thread correctly.	19
	Embroidery foot is attached incorrectly.	Attach the embroidery foot correctly.	9
	Screw of the presser foot holder is loose.	Securely tighten the screw of the presser foot.	10
	Fabric is too thick.	Use fabric that the needle can pierce when the handwheel is turned.	—
	Stabilizer is not attached to fabric being embroidered.	Attach stabilizer.	26
Bobbin thread is incorrectly wound.	Use a correctly wound bobbin.	15	

Problem	Cause	Solution	Page
Upper thread breaks.	Machine is not threaded correctly (used the wrong spool cap, spool cap is loose, the thread did not catch the needle bar threader, etc.).	Rethread the machine correctly.	21
	Knotted or tangled thread is being used.	Remove any knots or tangles.	—
	The selected needle is not appropriate for the thread being used.	Check the needle and fabric combination.	11, 49
	Upper thread tension is too tight.	Adjust the thread tension.	92
	Thread is twisted.	Use scissors, etc., to cut the twisted thread and remove it from the race, etc.	—
	Needle is turned, bent or the point is dull.	Replace the needle.	11
	Needle is installed incorrectly.	Reinstall the needle correctly.	11
	There are scratches around the opening of the needle plate. * There is a notch on the left side of the opening in the needle plate. This is not a scratch.	Replace the needle plate, or consult your authorized Baby Lock retailer.	—
			
	There are scratches around the opening in the embroidery foot.	Replace the embroidery foot, or consult your authorized Baby Lock retailer.	9
	There are scratches on the bobbin case.	Replace the bobbin case, or consult your authorized Baby Lock retailer.	—
	Using improper needle or thread for the selected fabric.	Check the needle and fabric combination.	11, 49
	The thread is tangled on the wrong side of the fabric.	While embroidering, the thread became knotted or tangled.	Rethread upper and lower thread.
A bobbin designed specifically for this machine is not used.		Use a bobbin designed specifically for this machine.	15
Upper threading is incorrect.		Check the steps for threading the machine and rethread the machine. Be sure that the embroidery foot is in the raised position when threading the machine so that the upper thread sets properly in the upper tension.	21
Using improper needle or thread for the selected fabric.		Check the needle and fabric combination.	11, 49
The upper thread is too tight.		The bobbin thread is incorrectly installed.	Correctly install the bobbin thread.
Bobbin thread breaks.	Bobbin is set incorrectly.	Reset the bobbin thread correctly.	19
	Bobbin thread is incorrectly wound.	Use a correctly wound bobbin.	15
	There are scratches on the bobbin or it doesn't rotate properly.	Replace the bobbin.	19
	Thread is twisted.	Use scissors, etc. to cut the twisted thread and remove it from the race, etc.	—
	A bobbin designed specifically for this machine is not used.	Use a bobbin designed specifically for this machine.	15
Fabric puckers.	There is a mistake in the upper or bobbin threading.	Check the steps for threading the machine and rethread it correctly.	19, 21
	Spool cap is set incorrectly.	Check the method for attaching the spool cap, then reattach the spool cap.	21
	Using improper needle or thread for the selected fabric.	Check the needle and fabric combination.	11, 49
	Needle is turned, bent or the point is dull.	Replace the needle.	11
	Thread tension is set incorrectly.	Adjust the thread tension.	92

Problem	Cause	Solution	Page
Skipped stitches	Machine is threaded incorrectly.	Check the steps for threading the machine and rethread it correctly.	21
	Using improper needle or thread for the selected fabric.	Check the needle and fabric combination.	11, 49
	Needle is turned, bent or the point is dull.	Replace the needle.	11
	Needle is installed incorrectly.	Reinstall the needle correctly.	11
	Needle is defective.	Replace the needle.	11
	Dust or lint has collected under the needle plate.	Remove the dust or lint with the brush.	—
High-pitched sound while embroidering	Pieces of thread are caught in the race.	Clean the race.	—
	Upper threading is incorrect.	Check the steps for threading the machine and rethread the machine.	21
	A bobbin designed specifically for this machine is not used.	Use a bobbin designed specifically for this machine.	15
	There are needle holes or friction scratches in the bobbin case.	Replace the bobbin case, or consult your authorized Baby Lock retailer.	—
The needle contacts the needle plate.	The needle clamp screw is loose.	Firmly tighten the needle clamp screw. If the needle is bent or blunt, replace it with a new one.	11
	Needle is turned, bent or the point is dull.	Replace the needle.	11
Fabric being embroidered with the machine cannot be removed.	Thread is tangled below the needle plate.	Lift up the fabric and cut the threads below it, and clean the race.	—
A broken needle has fallen into the machine.	—	Turn off the machine, and then remove the needle plate. If the needle that fell into the machine can be seen, use tweezers to remove it. After removing the needle, return the needle plate to its original position. Before turning on the machine, slowly turn the handwheel toward you to check that it turns smoothly. If the handwheel does not turn smoothly or the needle that fell into the machine cannot be removed, consult your authorized Baby Lock retailer.	—
The handwheel feels sluggish when it is turned.	Thread is tangled in the bobbin case.	Remove the tangled thread from the bobbin case. Re-install the bobbin case so it is correctly positioned.	—
The machine does not detect the embroidery positioning sticker.	Sunlight or light from the outside interferes with the machine.	Block light from the outside.	—
	The embroidery positioning sticker is shaded or hidden under fabric.	Make sure that nothing obstructs the embroidery positioning sticker.	
	The lighting is too bright or insufficient.	Adjust the brightness of the lighting.	
	Fabric was not inserted into the frame correctly (fabric was loose, etc.).	Set the fabric into the frame correctly.	
The scanned image is too bright or too pale.	Sunlight or light from the outside interferes with the machine.	Block light from the outside.	—

## ■ After Embroidering

Problem	Cause	Solution	Page
Thread tension is incorrect.	Upper threading is incorrect.	Check the steps for threading the machine and rethread the machine.	21
	Bobbin is set incorrectly.	Reset the bobbin. (If needle plate was removed, reinstall needle plate.)	19
	Using improper needle or thread for the selected fabric.	Check the needle and fabric combination.	11, 49
	Thread tension is set incorrectly.	Adjust the thread tension.	92
	Bobbin thread is incorrectly wound.	Use a correctly wound bobbin.	15
	Needle is turned, bent or the point is dull.	Replace the needle.	11
	A bobbin designed specifically for this machine is not used.	Use a bobbin designed specifically for this machine.	15
Embroidery pattern does not embroider out correctly.	Thread is twisted.	Use scissors, etc., to cut the twisted thread and remove it from the bobbin case, etc.	—
	Thread tension is set incorrectly.	Adjust the thread tension.	92
	Fabric was not inserted into the frame correctly (fabric was loose, etc.).	If the fabric is not stretched tight in the frame, the pattern may turn out poorly or there may be shrinkage of the pattern. Set the fabric into the frame correctly.	28
	Stabilizing material was not attached.	Always use stabilizing material, especially with stretch fabrics, lightweight fabrics, fabrics with a coarse weave, or fabrics that often cause pattern shrinkage. See your authorized Baby Lock retailer for the proper stabilizer.	26
	There was an object placed near the machine, and the carriage or embroidery frame hit the object during embroidering.	If the frame bumps something during embroidering, the pattern will turn out poorly. Do not place anything in the area where the frame may bump it during embroidering.	—
	Fabric outside the frame edges interferes with the free arm, so the embroidery unit cannot move.	Reinsert the fabric in the embroidery frame so that the excess fabric is away from the free arm, and rotate the pattern 180 degrees.	28
	Fabric is too heavy, so the embroidery unit cannot move freely.	Place a large thick book or similar object near the embroidery unit to lightly lift the heavy side and keep it level. Ensure that this object will not interfere with the movement of the embroidery arm or frame.	—
	Fabric is hanging off the table.	If the fabric is hanging off the table during embroidery, the embroidery unit will not move freely. Place the fabric so that it does not hang off the table or hold the fabric to keep it from dragging.	49
	Fabric is snagged or caught on something.	Stop the machine and place the fabric so that it does not get caught or snagged.	—
	Embroidery frame was removed during embroidering (for example, to reset the bobbin). The embroidery foot was bumped or moved while removing or attaching the embroidery frame, or the embroidery unit was moved.	If the embroidery foot is bumped or the embroidery unit is moved during embroidering, the pattern will not turn out. Be careful when removing or reattaching the embroidery frame during embroidering.	52
	Stabilizer is incorrectly attached, for example, it is smaller than the embroidery frame.	Attach the stabilizer correctly.	26
When restarting embroidering, for example, after the thread breaks, it may not be possible to continue embroidering, depending on the embroidery pattern.	Press the “Reinforcement Stitch” button to sew reinforcement stitches at the beginning of sewing, and then restart embroidering.	53	
Loops appear on the surface of the fabric when embroidering.	The thread tension is incorrectly set.	Adjust the thread tension.	92
	The tension of the upper thread is incorrectly set for the combination of the fabric, thread and pattern being used.	Use the embroidery needle plate cover.	30
	The combination of the bobbin case and bobbin thread is incorrect.	Change the bobbin case or bobbin thread so that the correct combination is used.	49

# ERROR MESSAGES

If the operation procedure is incorrect, the machine does not start. An alarm sounds and an error message is displayed on the LCD. If an error message displays, follow the instructions in the message.



Below is an explanation of error messages. Refer to these when necessary (if you touch  or do the operation correctly while the error message is displayed, the message disappears).

 **Memo**

- Refer to the Instruction and Reference Guide (Sewing) for error messages about the wireless LAN function.

	Error messages	Cause/solution
1	Cannot change the configuration of the characters.	This message is displayed when there are too many characters and the curved character configuration is impossible.
2	Cannot recognize the data for the selected pattern. The data may be corrupted.	This message is displayed when there is a possibility that the data for the selected pattern is corrupted.
3	Cannot recognize the embroidery positioning mark.	This message is displayed when the machine failed to recognize the embroidery positioning mark. - Confirm that the embroidery positioning mark is in the selected area. Refer to steps ③ through ④ of “Using the Embroidery Position Sticker to Align the Embroidering Position” on page 45. - Refer to “The machine does not detect the embroidery positioning sticker.” on page 196.
4	Change to a larger embroidery frame.	This message is displayed when the machine is in embroidery mode and the selected pattern is too large to fit in the attached frame. This message may also appear while aligning an embroidery pattern using the built-in camera and the repositioned pattern does not fit in the attached frame.
5	Data volume is too large for this pattern.	This message is displayed when the stitch patterns you are editing take up too much memory, or if you are editing too many stitch patterns for the memory. For a combined pattern, reduce the number of patterns.
6	Failed to save file.	This message is displayed when no more images can be saved on the USB media. In this case, delete a file from the USB media or use different USB media. (page 89)
7	Includes a special pattern that cannot be saved to external memory. Save the pattern in the machine’s memory.	This message is displayed when you try to save a copyright protected pattern to USB media or computer. According to copyright laws, patterns that are illegal to reproduce or edit cannot be saved to USB media or computer. If this message displays, save the pattern in the machine’s memory.
8	Lower the presser foot lever.	This message is displayed when the “Presser Foot Lifter” button is pressed while the presser foot lever is raised and the needle is lowered.
9	Not enough available memory to save the data. Delete some patterns or use a different media.	This message is displayed when the memory is full and the stitch or pattern cannot be saved.
10	OK to recall and resume previous memory?	This message appears if the machine is turned off while embroidering, then turned on again. Touch <input type="button" value="OK"/> to return the machine to the condition (pattern position and number of stitches) when it was turned off. Follow the procedure described in “If the Thread Breaks during Embroidering” on page 53 to align the needle position and embroider the remainder of the pattern.
11	OK to recall and resume previous memory? (IQ Designer)	This message is displayed when the machine is turned off while a pattern is being edited in IQ Designer, then turned on again, and then IQ Designer is started. Touch <input type="button" value="OK"/> to return to the screen before the machine was turned off.
12	OK to separate the combined border pattern?	This message is displayed when rotating a saved combined border pattern in the embroidery screen.
13	Pattern extends to the outside of embroidery frame.	This message is displayed when the machine is in embroidery mode, and the character pattern combination is too large to fit in the embroidery frame.
14	Pattern extends to the outside of embroidery frame. If you plan to add more patterns, rotate the pattern combination.	This message is displayed when the machine is in embroidery mode and the combined character pattern is too large for the embroidery frame. You can rotate the pattern 90 degrees and continue combining characters.
15	Preventive maintenance is recommended.	This message is displayed when the machine needs to be maintained.
16	Remove Dual Feed module from the machine.	This message appears when you try to start embroidering with the dual feed foot attached to the machine. Remove the dual feed foot before entering the embroidery mode.



	Error messages	Cause/solution
17	Remove the embroidery frame and replace the bobbin. OK to move the embroidery carriage to its previous position?	This message is displayed when replacing the embroidering bobbin thread. (page 52)
18	Remove the embroidery positioning mark.	This message is displayed when the machine has recognized the embroidery position mark. Remove the embroidery positioning sticker and touch  to continue. To remove the embroidery positioning sticker more easily, touch  . (page 47)
19	The bobbin thread is almost empty. * Use the "Reinforcement Stitch" button to sew a single stitch repeatedly and tie off the stitching. * Use the move frame key to move the embroidery carriage so the embroidery frame can be removed or installed. Afterward, the carriage moves back to its previous position.	This message is displayed when the bobbin thread is running out. Although a few stitches can be sewn when the "Start/Stop" button is pressed, replace with a wound bobbin immediately. (page 52)
20	The bobbin winder safety device has activated. Is the thread tangled?	This message is displayed when the bobbin is being wound, and the motor locks because the thread is tangled, etc.
21	The pattern extends out of the pattern area. Change position of the pattern and scan the new area.	This message appears when the built-in camera is being used to align the embroidery position, but the embroidery positioning sticker is too near an edge or the pattern extends from the embroidery frame. Change the positioning of the embroidery position sticker, and then try aligning the position again. Refer to page 45.
22	The safety device has been activated. Is the thread tangled? Is the needle bent?	This message is displayed when the motor locks due to tangled thread or for other reasons related to thread delivery.
23	This file cannot be used.	This message appears if the file format is incompatible with this machine. Check the list of compatible file formats. Refer to "SPECIFICATIONS" in the Instruction and Reference Guide (Sewing).
24	This file exceeds the data capacity and cannot be used. Use a suitable size file.	This message is displayed when the file size exceeds the data capacity of the machine. Confirm the file size and format. Refer to "SPECIFICATIONS" in the Instruction and Reference Guide (Sewing).
25	This key cannot be used at this time.	This message is displayed when you touch [Sewing Guide] in the screen other than the utility stitch, or touch [Pattern Explanation] in the screen other than the utility stitch or character/decorative stitch.
26	This USB media cannot be used.	This message is displayed when you try to use incompatible media. For a list of compatible USB media, visit " <a href="http://www.babylock.com">www.babylock.com</a> ".
27	Turn off the machine before attaching or removing the needle plate.	This message is displayed when the needle plate is removed with the machine on or when the machine is turned on and embroidery mode is selected.
28	USB media error	This message is displayed when an error occurs with the USB media. For a list of compatible USB media, visit " <a href="http://www.babylock.com">www.babylock.com</a> ".

# INDEX

## A

Aligning the position .....	43, 45, 86
Alphabet characters	
embroidery .....	70
Appliqué .....	108, 111, 112
Appliqué piece .....	104
Array key .....	73
Arrow keys .....	59
Automatic threading button .....	21

## B

Ball point needle for embroidery .....	11
Bobbin	
runs out of thread .....	52
setting .....	19
winding .....	15
Bobbin case .....	49
Bobbin cover .....	19
Bobbin thread .....	49
Bobbin winding switch .....	17
Border key .....	62, 64
Built-in camera .....	45

## C

Character spacing key .....	74
Color visualizer function .....	77
Combining patterns .....	80
Connecting patterns .....	140
Couching patterns .....	113
Cut/Tension key .....	92

## D

Decorative fill pattern .....	116, 155, 159
Density key .....	61
Deselect region setting .....	68

## E

Echo quilting .....	116
Edge-to-edge quilt function .....	117
Editing .....	35
Embroidery	
adjusting the speed .....	97
automatic thread cutting function (end color trim) .....	95
changing the thread color .....	76
combined patterns .....	80
edges or corners .....	31
repeated patterns .....	62
restarting from the beginning .....	54
resuming embroidery after turning off the power .....	54
ribbons or tape .....	31
selecting patterns .....	33
small fabrics .....	31
thread color display .....	97
thread trimming function (jump stitch trim) .....	96
Embroidery appliqué .....	108
Embroidery foot "W" .....	10
Embroidery foot code .....	38
Embroidery frame display .....	97
Embroidery frames	
attaching .....	32
inserting fabric .....	28
removing .....	32
types .....	27
using the embroidery sheet .....	29
Embroidery needle plate cover .....	30

## Embroidery patterns

aligning the position .....	86
checking the position .....	47
combining .....	80
duplicating .....	67
editing .....	35
embroidering .....	49
linked characters .....	99
pattern selection screens .....	34
retrieving .....	102
saving .....	101
selecting .....	33
using a frame pattern to make an appliqué .....	111, 112
Embroidery positioning sticker .....	45
Embroidery sheet .....	29
Embroidery unit .....	13
Error messages .....	198

## F

Flat bed attachment .....	13
Font .....	70
Forward/Back key .....	53, 54

## I

Image key .....	58
Importing decorative fill pattern data .....	159
Importing motif stitch pattern data .....	159
IQ Designer .....	150
IQ Intuition- Monitoring App .....	56
IQ Intuition- Positioning App .....	188

## K

Key functions .....	35
---------------------	----

## L

Large-size split embroidery patterns .....	135
Lower threading	
setting the bobbin .....	19
winding the bobbin .....	15

## M

Machine operation mode key .....	193
Mirror image key .....	62
Motif stitch pattern .....	153, 159

## N

Needle .....	11
--------------	----

## P

Presser foot/Needle exchange key .....	9, 11
Pretension disk .....	16, 18
Projector .....	42, 43

## Q

Quilting border patterns .....	123, 126, 131
--------------------------------	---------------

## R

Repeated patterns .....	62
Retrieving	
USB media/SD card .....	102
Rotate key .....	59

**S**

Saving	
embroidery patterns .....	101
machine's memory .....	101
Scan .....	164
SD card	
recalling .....	102
usable .....	101
Settings	
automatic thread cutting .....	95
embroidery settings .....	7
machine setting mode key .....	7
sewing settings .....	7
thread tension .....	92
thread trimming .....	96
Size key .....	60
Spool stand .....	19, 24
Stabilizer .....	26
Starting point key .....	98
Stippling .....	116, 175
Supplemental spool pin .....	15

**T**

Thread	
thread tension .....	92
Thread color display .....	97
Thread guide .....	16, 18
Thread guide plate .....	18, 21
Thread marks .....	64
Thread palette key .....	76
Trial key .....	47
Troubleshooting .....	192

**U**

Uninterrupted embroidering .....	86
Upper threading	
using the "Automatic Threading" button .....	21
USB media	
recalling .....	102

# Solaris<sup>TM</sup> VISION



FOR THE LOVE OF SEWING