

Crescendo™

Quick Reference Guide

Model BLCR



FOR THE LOVE OF SEWING

To register your machine warranty and receive Baby Lock product updates and offers, go to babylock.com/profile. If you have questions with registration, visit your Authorized Baby Lock Retailer.

Baby Lock Consumer Helpline: 800-313-4110

www.babylock.com

Refer to the instruction and reference guide for detailed instruction.
 Also, there are differences in the keys and screens depending on the display language. In this guide, English screens are used for basic explanations.

Para obtener instrucciones más detalladas, consulte el Manual de instrucciones.
 Además, dependiendo del idioma visualizado algunos botones y pantallas podrán ser diferentes. En esta guía, para las explicaciones básicas se emplean pantallas en inglés.

Pour des instructions détaillées, reportez-vous au manuel d'instructions.
 Par ailleurs, il y a des différences dans les touches et les écrans en fonction de la langue d'affichage.
 Dans ce guide, les explications de base utilisent les écrans anglais.

<English display>
 <Visualización en inglés>
 <Affichage en anglais>

<Example: Spanish>
 <Ejemplo: Español>
 <Exemple : espagnol>

<Example: French>
 <Ejemplo: Français>
 <Exemple : français>

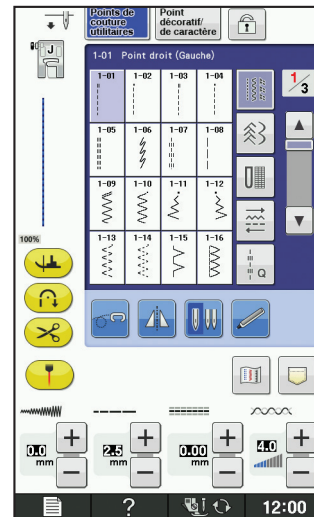
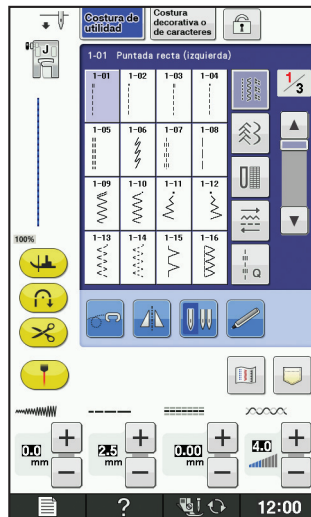
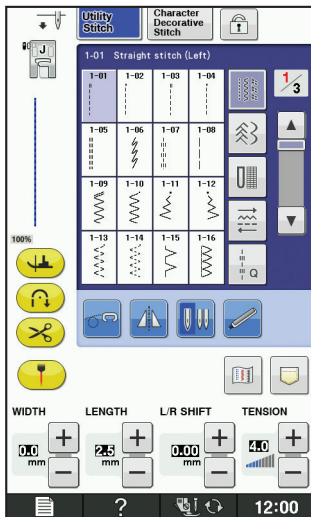

Contents

| | |
|----------------------------------|---|
| Winding the Bobbin | 2 |
| Setting the Bobbin | 4 |
| Upper Threading | 5 |
| Selecting Stitch Patterns | 6 |
| Summary of Stitch Patterns | 9 |

Contenido

| | |
|-------------------------------------|---|
| Devanado de la bobina | 2 |
| Colocación de la bobina | 4 |
| Hilo superior | 5 |
| Selección de tipos de puntada | 6 |
| Resumen de tipos de puntada | 9 |

Table des matières

| | |
|---|---|
| Bobinage de la canette | 2 |
| Mise en place de la canette | 4 |
| Enfilage supérieur | 5 |
| Sélection des configurations de point | 6 |
| Sommaire des motifs de point | 9 |

Winding the Bobbin

Devanado de la bobina

Bobinage de la canette

Follow the numbered steps below in order. Refer to the instruction and reference guide for detailed instruction.
 Realice los siguientes pasos numerados en el orden indicado. Para obtener instrucciones más detalladas, consulte el Manual de instrucciones.
 Suivez les étapes numérotées ci-dessous dans l'ordre. Pour des instructions détaillées, reportez-vous au manuel d'instructions.

Use only the enclosed bobbin or bobbins of the same type.
 Utilice sólo la bobina incluida o bobinas del mismo tipo.
 N'utilisez que la canette fournie ou des canettes du même type.

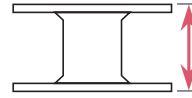

11.5 mm (approx. 7/16 inch)
 (aprox. 7/16 pulg.)
 (env. 7/16 po)

◆ Using the Supplemental Spool Pin

You can wind the bobbin during sewing.

◆ Uso del portacarrete suplementario

Puede devanar la bobina mientras está cosiendo.

◆ Utilisation du porte-bobine supplémentaire

Vous pouvez bobiner la canette pendant la couture.

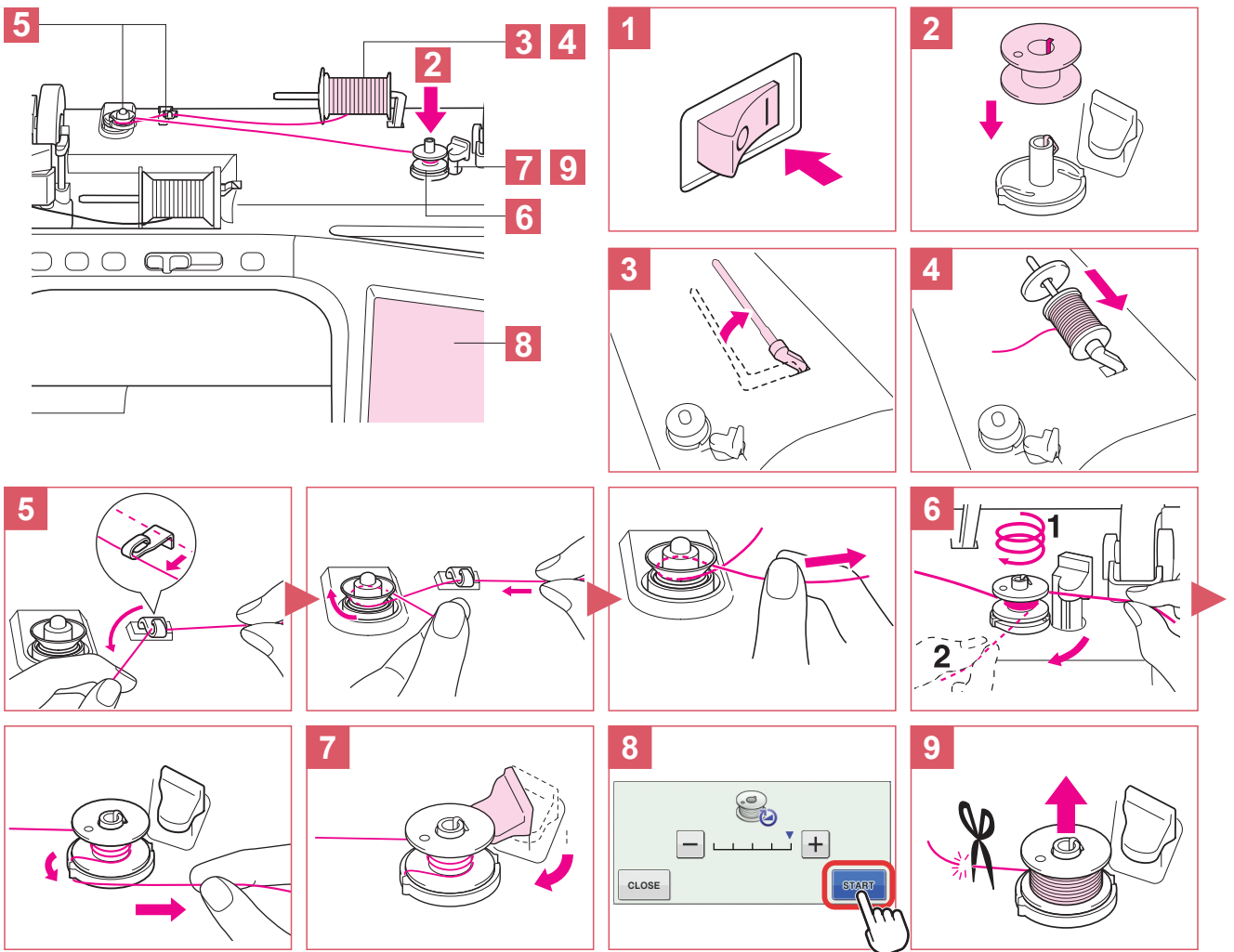

◆ Using the Spool Pin

You can use the main spool pin to wind the bobbin before sewing.

◆ Uso del portacarrete

Puede utilizar el portacarrete principal para devanar la bobina antes de coser.

◆ Utilisation du porte-bobine

Vous pouvez bobiner la canette avant de coudre à l'aide du porte-bobine principal.

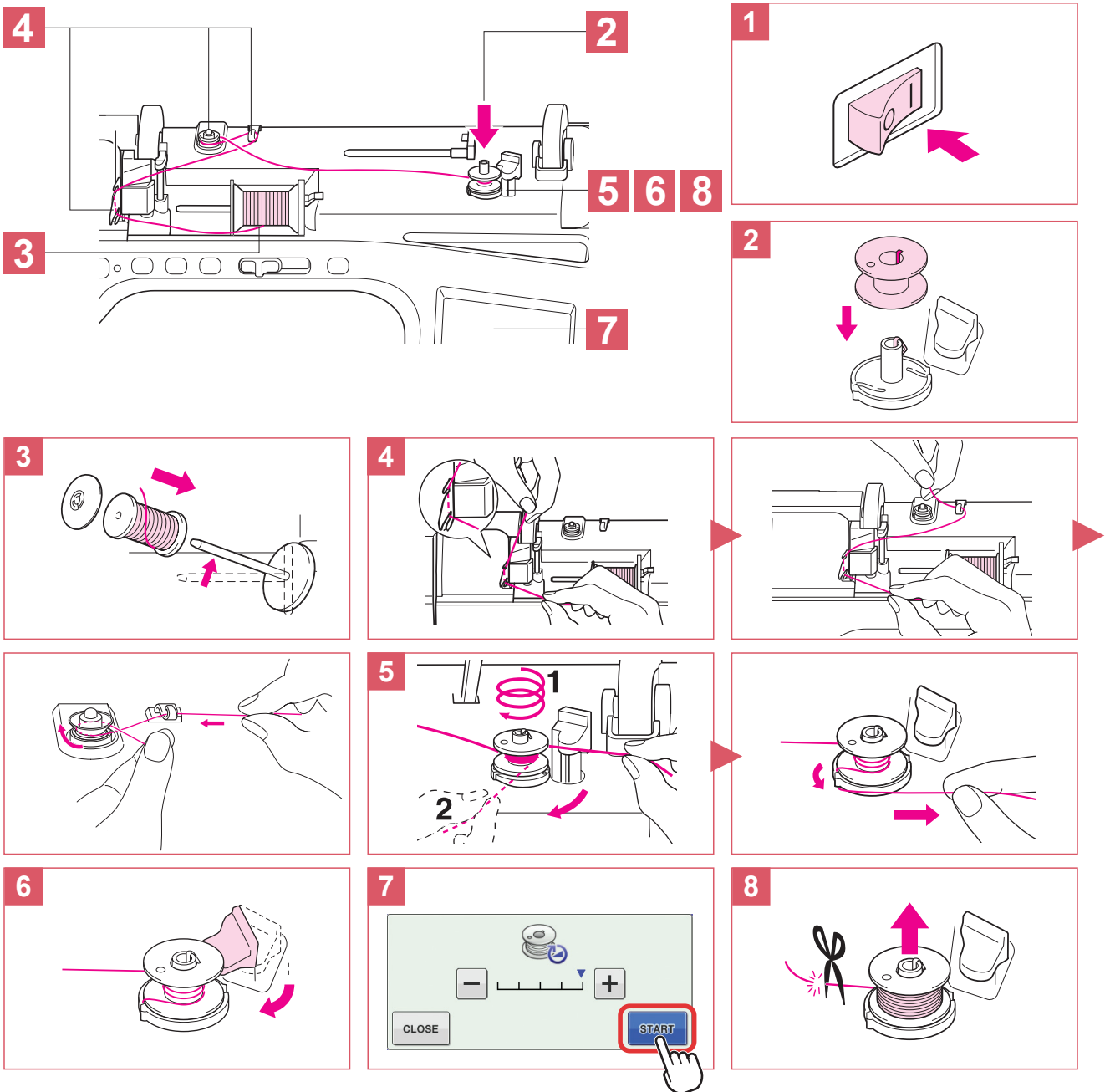

Setting the Bobbin

Colocación de la bobina

Mise en place de la canette

Refer to the instruction and reference guide for detailed instruction.
Para obtener instrucciones más detalladas, consulte el Manual de instrucciones.
Pour des instructions détaillées, reportez-vous au manuel d'instructions.

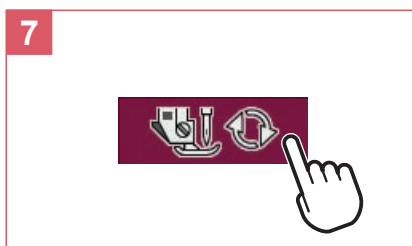
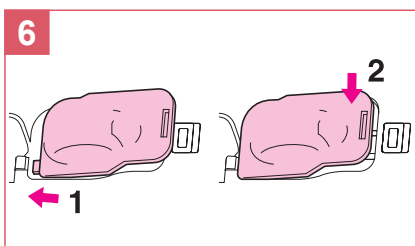
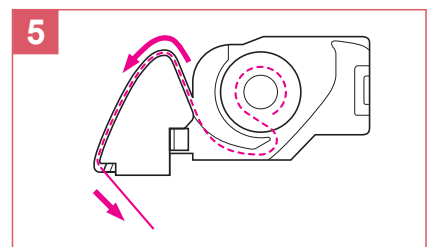
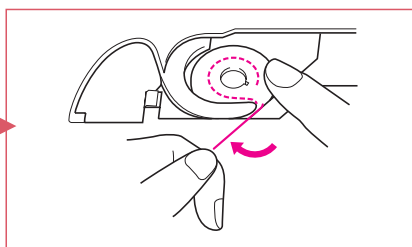
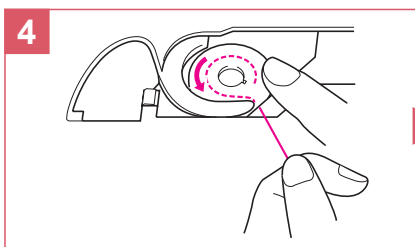
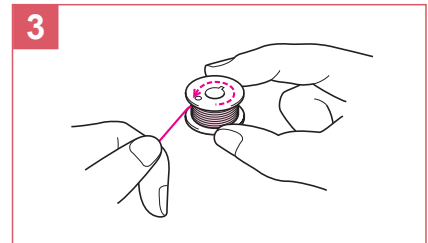
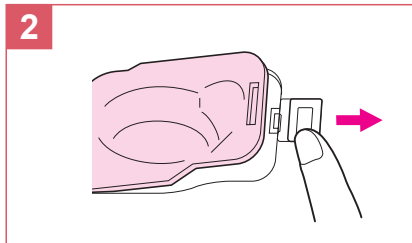
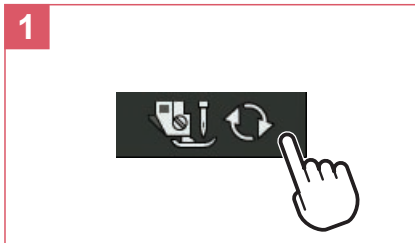

Upper Threading

Hilo superior

Enfilage supérieur

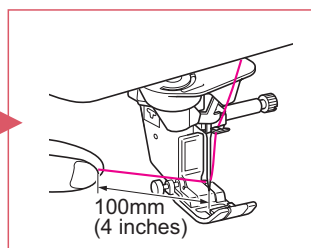
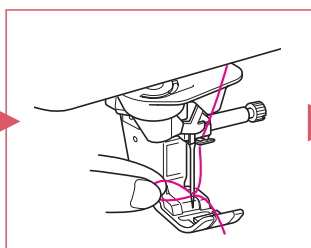
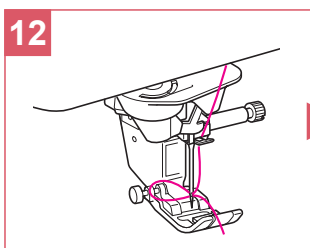
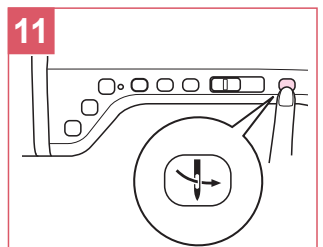
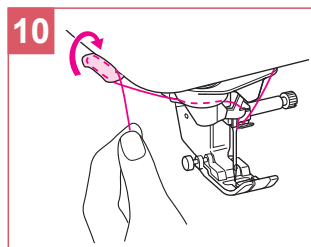
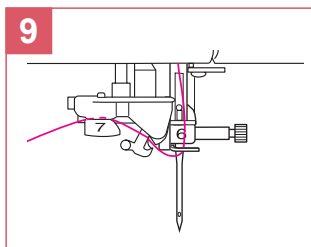
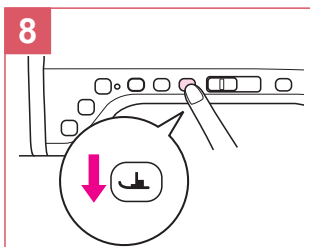
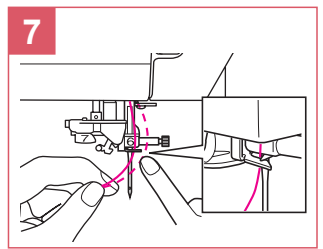
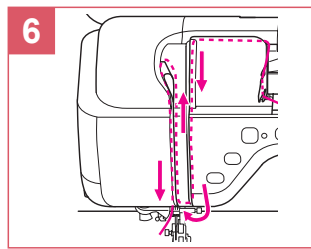
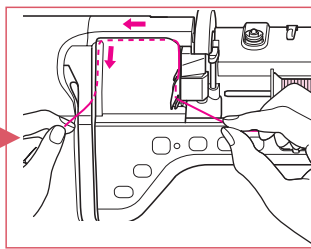
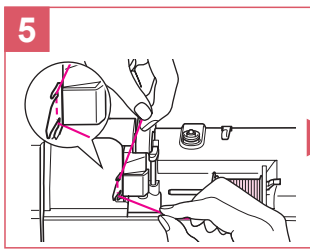
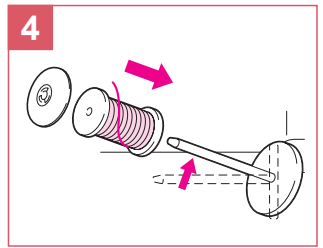
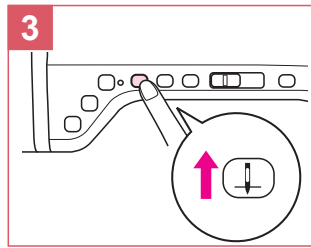
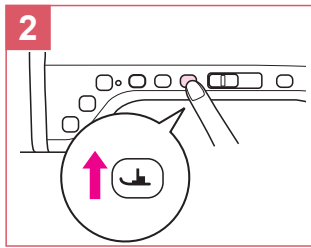
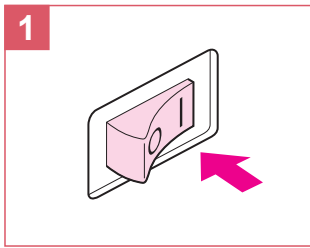
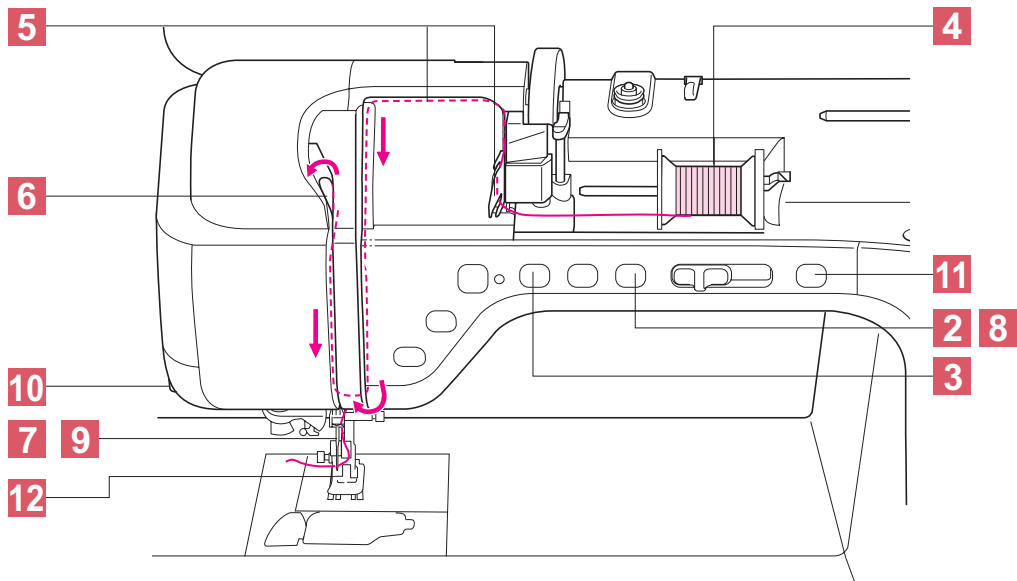

Selecting Stitch Patterns

Selección de tipos de puntada

Sélection des configurations de point

◆ LCD Flow Chart

◆ Diagrama de flujo del LCD

◆ Organigramme de l'écran à cristaux liquides

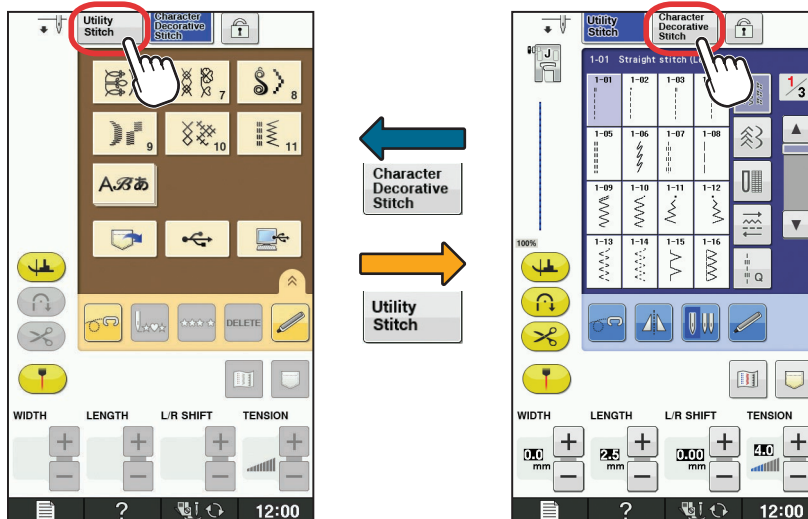

◆ Utility Stitches

When the machine is turned on, the opening movie is played. Touch the screen to display the Utility Stitch selection screen. Either “1-01 Straight stitch (Left)” or “1-03 Straight stitch (Middle)” is selected, depending on the setting selected in the settings screen.

◆ Puntadas utiles

Cuando se activa la máquina, se reproduce el vídeo de presentación. Toque la pantalla para visualizar la pantalla de selección de puntada con aplicaciones. Se seleccionará la “Puntada recta 1-01 (izquierda)” o la “Puntada recta 1-03 (medio)”, según el ajuste seleccionado en la pantalla de ajustes.

◆ Points utilitaires

Quand la machine est mise sous tension, la vidéo de démarrage commence. Touchez l'écran pour afficher l'écran de sélection Point utilitaire. Soit « 1-01 Point droit (Gauche) », soit « 1-03 Point droit (Milieu) » est sélectionné, selon le réglage sélectionné sur l'écran de réglage.

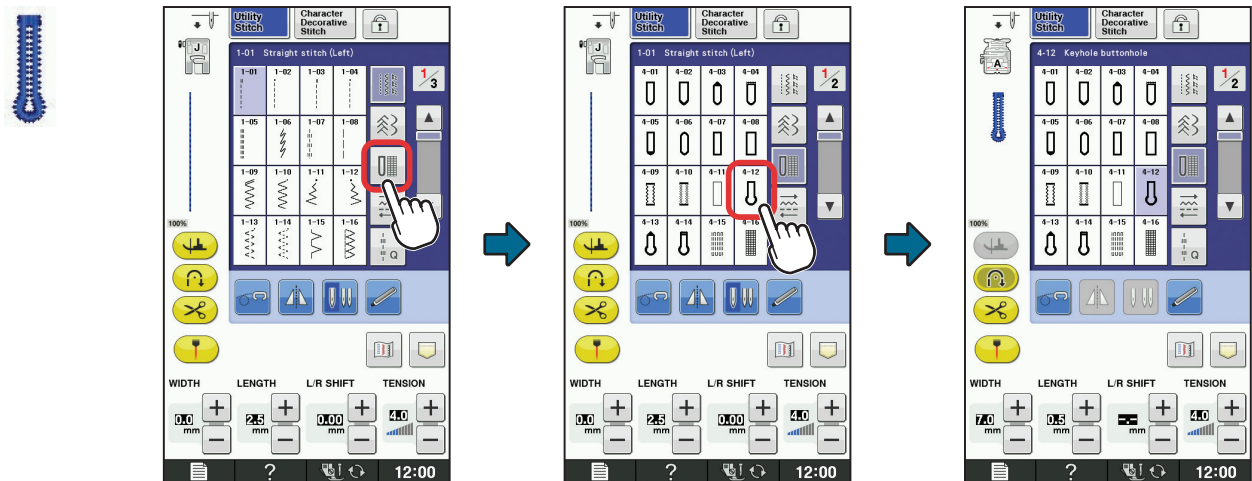

◆ Character/Decorative Stitches

◆ Puntadas de letras/decorativas

◆ Caractères/points décoratifs

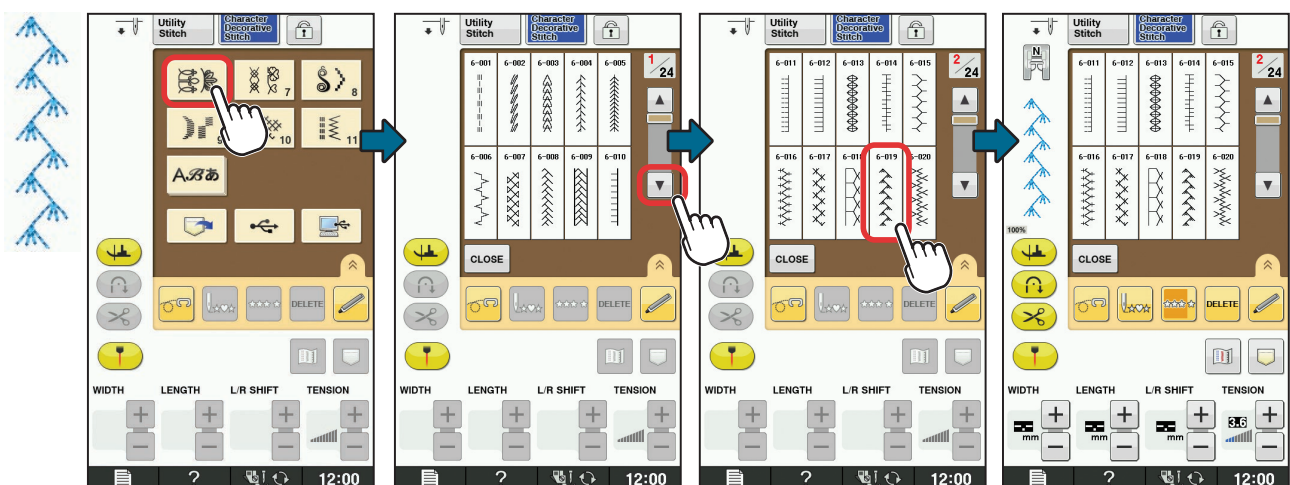

◆ Settings

◆ Ajustes

◆ Réglages



Summary of Stitch Patterns

Resumen de tipos de puntada

Sommaire des motifs de point

◆ Utility Stitches

◆ Puntadas utiles

◆ Points utilitaires

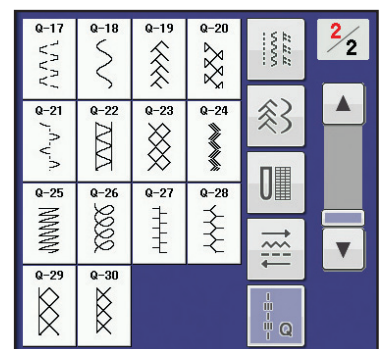
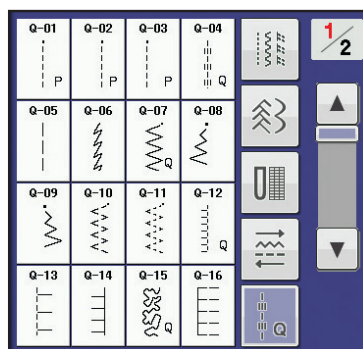
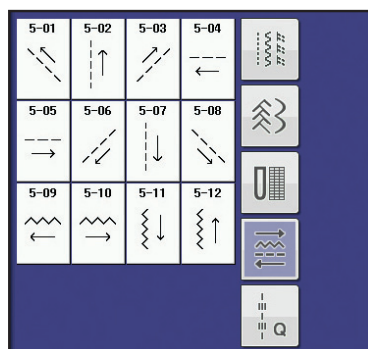
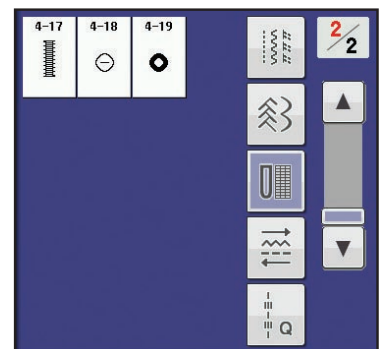
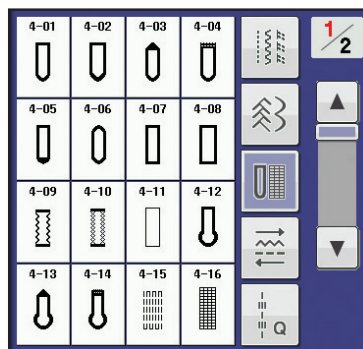
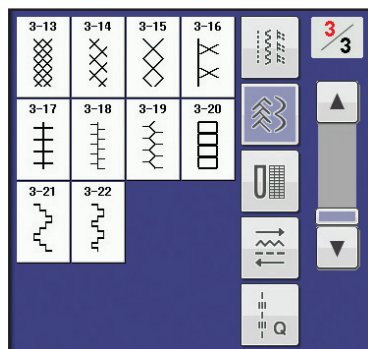
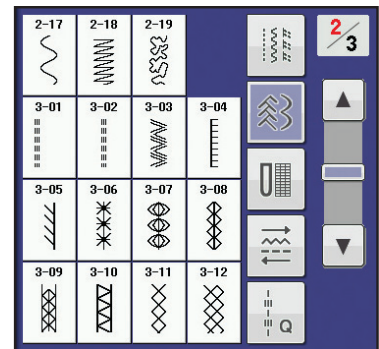
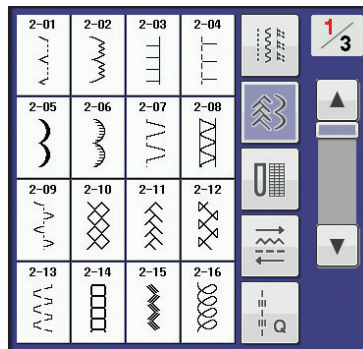
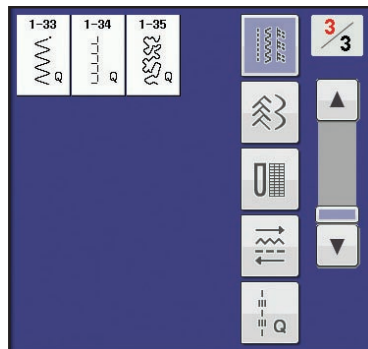
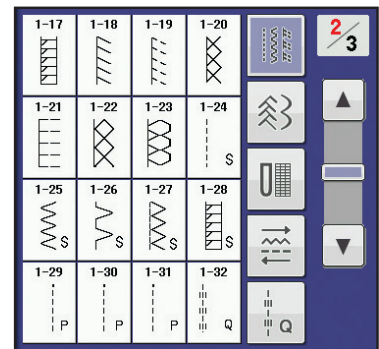
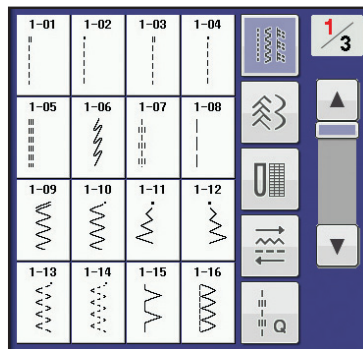
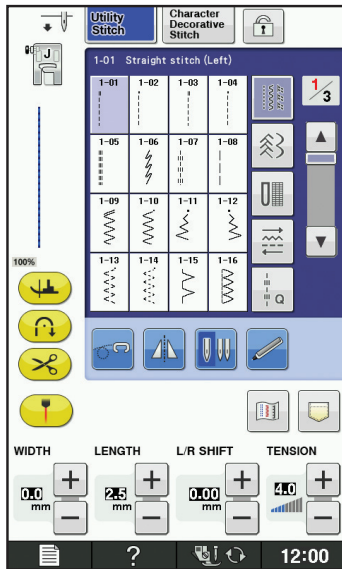

◆ Character/Decorative Stitches

◆ Puntadas de letras/decorativas

◆ Caractères/points décoratifs

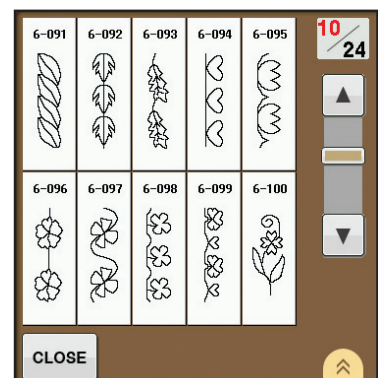
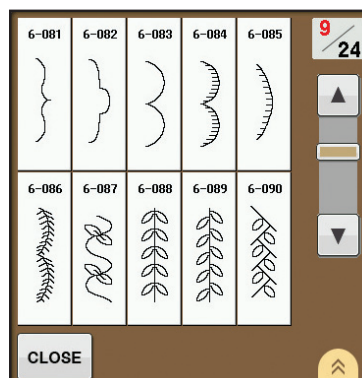
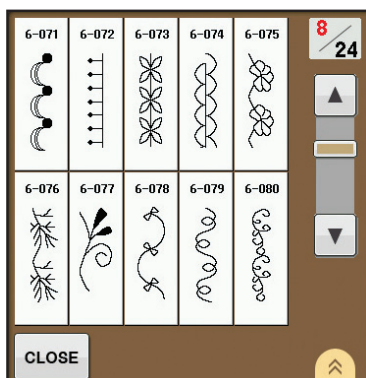
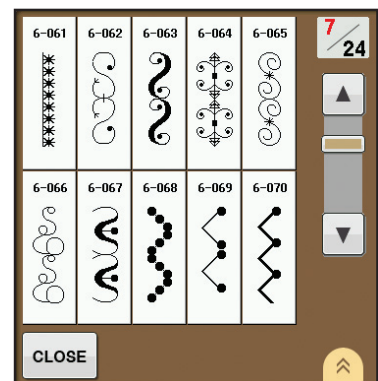
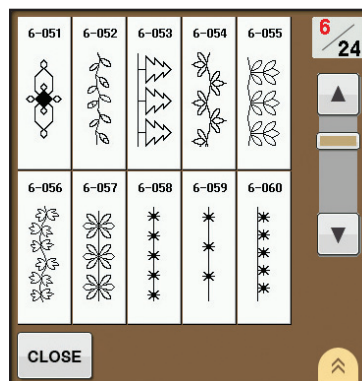
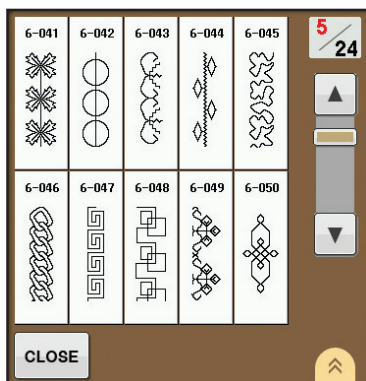
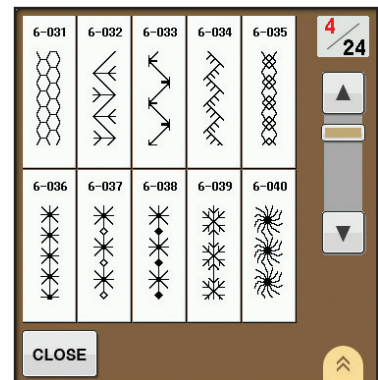
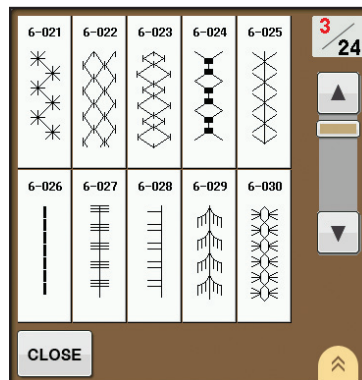
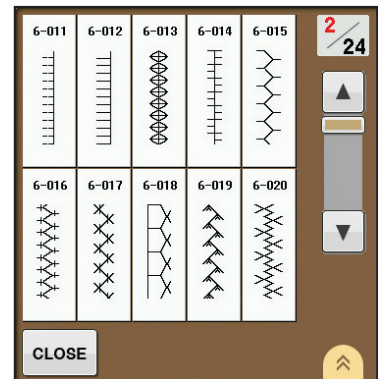
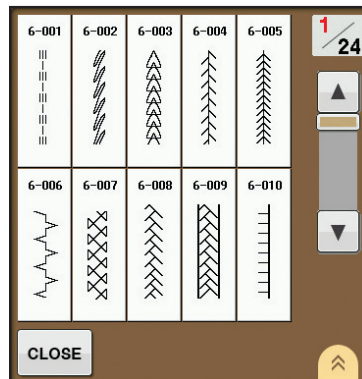
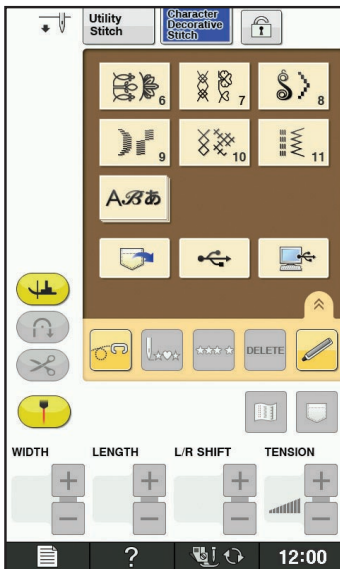

Summary of Stitch Patterns
Resumen de tipos de puntada
Sommaire des motifs de point

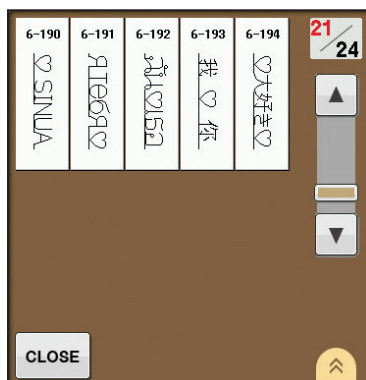
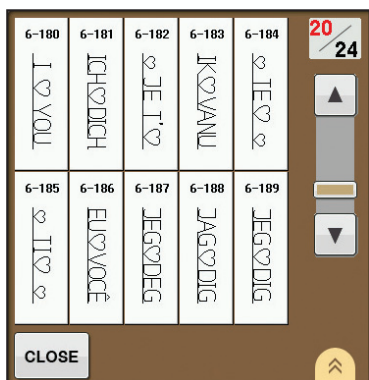
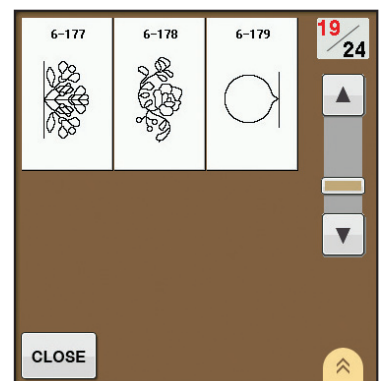
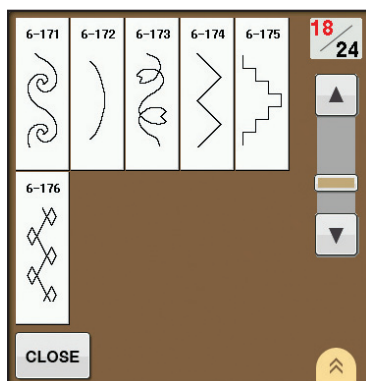
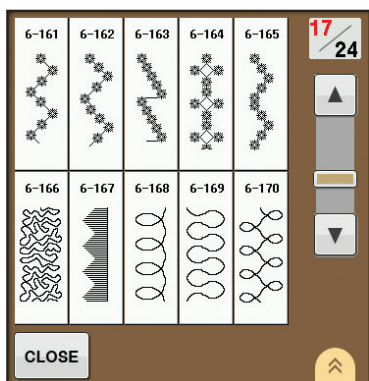
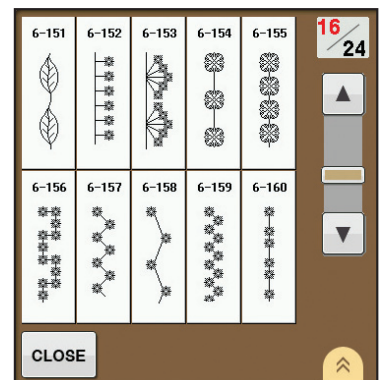
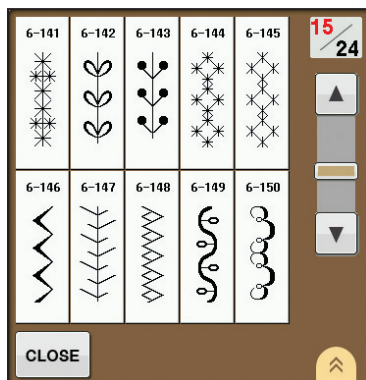
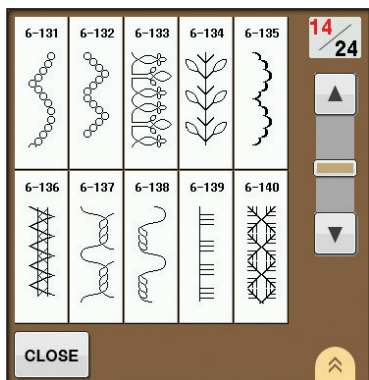
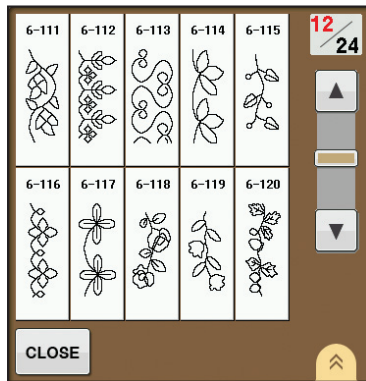
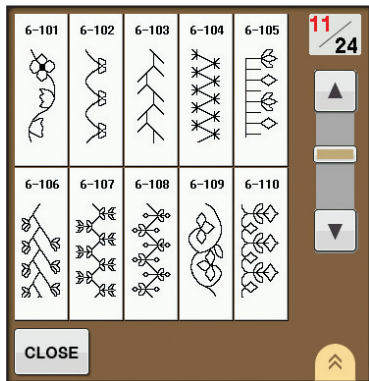

6-180: English
6-181: German
6-182: French
6-183: Dutch
6-184: Spanish
6-185: Italian
6-186: Portuguese
6-187: Norwegian
6-188: Swedish
6-189: Danish
6-190: Finnish
6-191: Russian
6-192: Thai
6-193: Simplified
Chinese
6-194: Japanese

6-180: Inglés
6-181: Alemán
6-182: Francés
6-183: Holandés
6-184: Español
6-185: Italiano
6-186: Portugués
6-187: Noruego
6-188: Sueco
6-189: Danés
6-190: Finés
6-191: Ruso
6-192: Tailandés
6-193: Chino
simplificado
6-194: Japonés

6-180 : anglais
6-181 : allemand
6-182 : français
6-183 : néerlandais
6-184 : espagnol
6-185 : italien
6-186 : portugais
6-187 : norvégien
6-188 : suédois
6-189 : danois
6-190 : finnois
6-191 : russe
6-192 : thaïlandais
6-193 : chinois
simplifié
6-194 : japonais

| | | | | | |
|-------|-------|-------|-------|-------|---------|
| 6-195 | 6-196 | 6-197 | 6-198 | 6-199 | 22 / 24 |
| | | | | | |
| 6-200 | 6-201 | 6-202 | 6-203 | 6-204 | |
| | | | | | |
| CLOSE | | | | | ▲ |
| | | | | | ▼ |
| | | | | | ⏪ |

| | | | | | |
|-------|-------|-------|-------|-------|---------|
| 6-205 | 6-206 | 6-207 | 6-208 | 6-209 | 23 / 24 |
| | | | | | |
| 6-210 | 6-211 | 6-212 | 6-213 | 6-214 | |
| | | | | | |
| CLOSE | | | | | ▲ |
| | | | | | ▼ |
| | | | | | ⏪ |

| | | | | | |
|-------|-------|-------|-------|-------|---------|
| 6-215 | 6-216 | 6-217 | 6-218 | 6-219 | 24 / 24 |
| | | | | | |
| CLOSE | | | | | ▲ |
| | | | | | ▼ |
| | | | | | ⏪ |

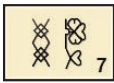

| | | | | | |
|-------|-------|-------|-------|-------|-------|
| 7-001 | 7-002 | 7-003 | 7-004 | 7-005 | 1 / 8 |
| | | | | | |
| 7-006 | 7-007 | 7-008 | 7-009 | 7-010 | |
| | | | | | |
| CLOSE | | | | | ▲ |
| | | | | | ▼ |
| | | | | | ⏪ |

| | | | | | |
|-------|-------|-------|-------|-------|-------|
| 7-011 | 7-012 | 7-013 | 7-014 | 7-015 | 2 / 8 |
| | | | | | |
| 7-016 | 7-017 | 7-018 | 7-019 | 7-020 | |
| | | | | | |
| CLOSE | | | | | ▲ |
| | | | | | ▼ |
| | | | | | ⏪ |

| | | | | | |
|-------|-------|-------|-------|-------|-------|
| 7-021 | 7-022 | 7-023 | 7-024 | 7-025 | 3 / 8 |
| | | | | | |
| 7-026 | 7-027 | 7-028 | 7-029 | 7-030 | |
| | | | | | |
| CLOSE | | | | | ▲ |
| | | | | | ▼ |
| | | | | | ⏪ |

| | | | | | |
|-------|-------|-------|-------|-------|-------|
| 7-031 | 7-032 | 7-033 | 7-034 | 7-035 | 4 / 8 |
| | | | | | |
| 7-036 | 7-037 | 7-038 | 7-039 | 7-040 | |
| | | | | | |
| CLOSE | | | | | ▲ |
| | | | | | ▼ |
| | | | | | ⏪ |

| | | | | | |
|-------|-------|-------|-------|-------|-------|
| 7-041 | 7-042 | 7-043 | 7-044 | 7-045 | 5 / 8 |
| | | | | | |
| 7-046 | 7-047 | 7-048 | 7-049 | 7-050 | |
| | | | | | |
| CLOSE | | | | | ▲ |
| | | | | | ▼ |
| | | | | | ⏪ |

| | | |
|-------|-------|-------|
| 7-051 | 7-052 | 6 / 8 |
| | | |
| CLOSE | | ▲ |
| | | ▼ |
| | | ⏪ |

| | | | | | |
|-------|-------|-------|-------|-------|-------|
| 7-053 | 7-054 | 7-055 | 7-056 | 7-057 | 7 / 8 |
| | | | | | |
| 7-058 | 7-059 | 7-060 | 7-061 | 7-062 | |
| | | | | | |
| CLOSE | | | | | ▲ |
| | | | | | ▼ |
| | | | | | ⏪ |

| | | |
|-------|-------|-------|
| 7-063 | 7-064 | 8 / 8 |
| | | |
| CLOSE | | ▲ |
| | | ▼ |
| | | ⏪ |

Summary of Stitch Patterns
Resumen de tipos de puntada
Sommaire des motifs de point

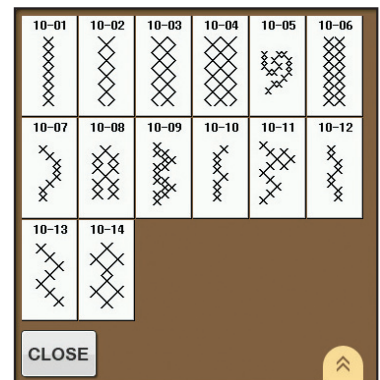
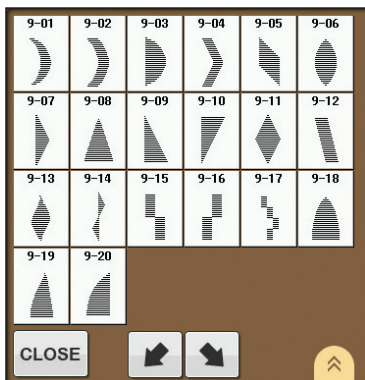
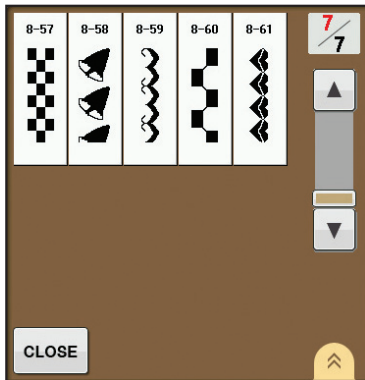
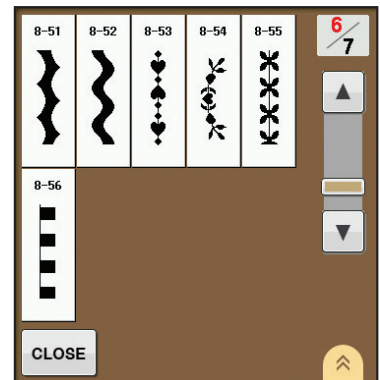
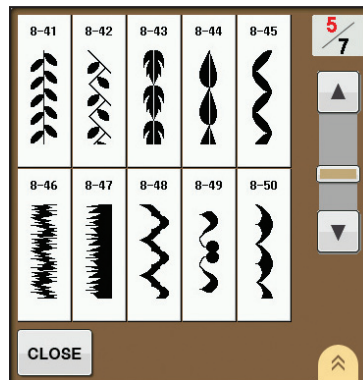
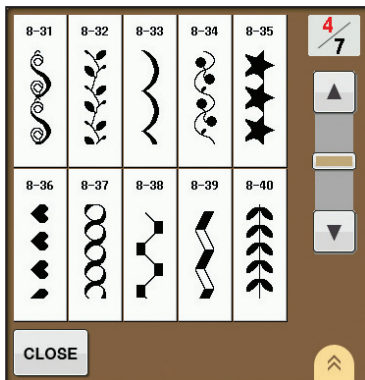
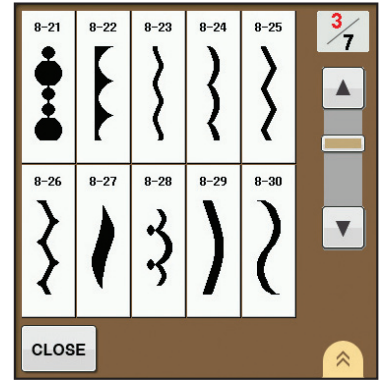
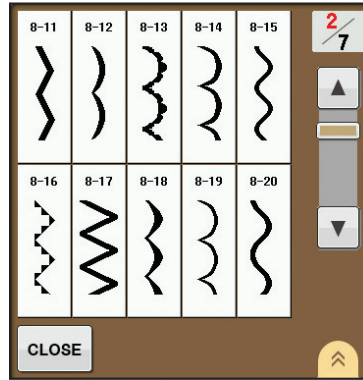
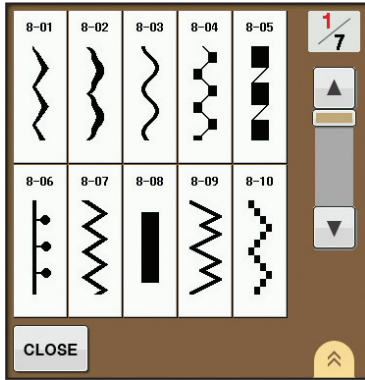



| | | | | |
|-------|-------|-------|-------|-------|
| 11-01 | 11-02 | 11-03 | 11-04 | 11-05 |
| 11-06 | 11-07 | 11-08 | 11-09 | 11-10 |
| 11-11 | 11-12 | 11-13 | 11-14 | 11-15 |
| 11-16 | 11-17 | 11-18 | 11-19 | 11-20 |

CLOSE

| | | | | |
|-------|-------|-------|-------|-------|
| 11-21 | 11-22 | 11-23 | 11-24 | 11-25 |
| 11-26 | 11-27 | 11-28 | 11-29 | 11-30 |
| 11-31 | 11-32 | 11-33 | 11-34 | 11-35 |
| 11-36 | 11-37 | 11-38 | 11-39 | 11-40 |

CLOSE

| | | | | |
|-------|-------|-------|-------|-------|
| 11-41 | 11-42 | 11-43 | 11-44 | 11-45 |
| 11-46 | 11-47 | 11-48 | 11-49 | 11-50 |
| 11-51 | 11-52 | 11-53 | 11-54 | 11-55 |
| 11-56 | 11-57 | 11-58 | | |

CLOSE

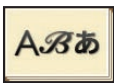

Utility Stitch | Character Decorative Stitch

AB *AB* AB

AB あア年組 0~9&?!

CLOSE

WIDTH LENGTH L/R SHIFT TENSION

12:00



| | | | | | |
|---|---|---|---|---|-------|
| A | B | C | D | E | ABC |
| F | G | H | I | J | abc |
| K | L | M | N | O | 0-9,. |
| P | Q | R | S | T | &?! |
| U | V | W | X | Y | ÄÄä |
| Z | ' | _ | | | ÖÖö |

CLOSE

| | | | | | |
|---|---|---|---|---|-------|
| α | b | c | d | e | ABC |
| f | g | h | i | j | abc |
| k | l | m | n | o | 0-9,. |
| p | q | r | s | t | &?! |
| u | v | w | x | y | ÄÄä |
| z | ' | _ | | | ÖÖö |

CLOSE

| | | | | | |
|---|---|----|---|---|-------|
| 0 | 1 | 2 | 3 | 4 | ABC |
| 5 | 6 | 7 | 8 | 9 | abc |
| # | % | \$ | £ | € | 0-9,. |
| ¥ | - | + | X | ÷ | &?! |
| = | * | . | , | ' | ÄÄä |
| _ | | | | | ÖÖö |

CLOSE

| | | | | | |
|---|---|---|---|---|-------|
| & | ? | ! | @ | < | ABC |
| > | (|) | [|] | abc |
| / | \ | ~ | : | ; | 0-9,. |
| © | ® | ™ | “ | ” | &?! |
| ” | ' | ‘ | ’ | _ | ÄÄä |
| | | | | | ÖÖö |

CLOSE

| | | | | | |
|---|---|---|---|---|-------|
| Â | Ä | Å | ä | å | ABC |
| â | ä | å | æ | Æ | abc |
| æ | Ç | ç | È | É | 0-9,. |
| Ê | Ë | è | é | ê | &?! |
| ë | Ï | ì | ï | Ð | ÄÄä |
| Ñ | ñ | Í | í | _ | ÖÖö |

CLOSE

| | | | | | |
|---|---|---|---|---|-------|
| Ô | Ö | Ø | ò | ó | ABC |
| ô | ö | ø | û | ü | abc |
| ù | ú | û | ü | þ | 0-9,. |
| ƒ | ß | ı | İ | Ñ | &?! |
| Õ | õ | Œ | œ | ř | ÄÄä |
| ť | ž | ' | _ | | ÖÖö |

CLOSE

AB

| | | | | | |
|---|---|---|---|---|-------|
| A | B | C | D | E | ABC |
| F | G | H | I | J | abc |
| K | L | M | N | O | 0-9,. |
| P | Q | R | S | T | &?! |
| U | V | W | X | Y | ÄÄä |
| Z | ' | _ | | | ÖÖö |

CLOSE

| | | | | | |
|---|---|---|---|---|-------|
| a | b | c | d | e | ABC |
| f | g | h | i | j | abc |
| k | l | m | n | o | 0-9,. |
| p | q | r | s | t | &?! |
| u | v | w | x | y | ÄÄä |
| z | ' | _ | | | ÖÖö |

CLOSE

| | | | | | |
|---|---|----|---|---|-------|
| 0 | 1 | 2 | 3 | 4 | ABC |
| 5 | 6 | 7 | 8 | 9 | abc |
| # | % | \$ | £ | € | 0-9,. |
| ¥ | - | + | × | ÷ | &?! |
| = | * | . | , | ' | ÄÄä |
| _ | | | | | ÖÖö |

CLOSE

| | | | | | |
|---|---|---|---|---|-------|
| & | ? | ! | @ | < | ABC |
| > | (|) | [|] | abc |
| / | \ | ~ | : | ; | 0-9,. |
| © | ® | ™ | “ | ” | &?! |
| ” | ' | ' | ' | _ | ÄÄä |
| | | | | | ÖÖö |

CLOSE

| | | | | | |
|---|---|---|---|---|-------|
| À | Á | Â | à | á | ABC |
| ä | ã | ä | å | Æ | abc |
| æ | Ç | ç | È | É | 0-9,. |
| Ê | Ë | è | é | ê | &?! |
| ë | Ï | ì | í | Ð | ÄÄä |
| Ñ | ñ | Î | í | _ | ÖÖö |

CLOSE

| | | | | | |
|---|---|---|---|---|-------|
| Ô | Ö | Ø | ò | ó | ABC |
| ô | ö | ø | û | ü | abc |
| ù | ú | û | ü | Þ | 0-9,. |
| ƒ | ß | ı | İ | Ń | &?! |
| Ö | ö | œ | æ | ƒ | ÄÄä |
| t | z | ' | _ | | ÖÖö |

CLOSE

AB

| | | | | | |
|---|---|---|---|---|-------|
| A | B | C | D | E | ABC |
| F | G | H | I | J | abc |
| K | L | M | N | O | 0-9,. |
| P | Q | R | S | T | &?! |
| U | V | W | X | Y | ÄÄä |
| Z | ' | _ | | | ÖÖö |

CLOSE

| | | | | | |
|---|---|---|---|---|-------|
| a | b | c | d | e | ABC |
| f | g | h | i | j | abc |
| k | l | m | n | o | 0-9,. |
| p | q | r | s | t | &?! |
| u | v | w | x | y | ÄÄä |
| z | ' | _ | | | ÖÖö |

CLOSE

| | | | | | |
|---|---|----|---|---|-------|
| 0 | 1 | 2 | 3 | 4 | ABC |
| 5 | 6 | 7 | 8 | 9 | abc |
| # | % | \$ | £ | € | 0-9,. |
| ¥ | - | + | × | ÷ | &?! |
| = | * | . | , | ' | ÄÄä |
| _ | | | | | ÖÖö |

CLOSE

| | | | | | |
|---|---|---|---|---|-------|
| & | ? | ! | @ | < | ABC |
| > | (|) | [|] | abc |
| / | \ | ~ | : | ; | 0-9,. |
| © | ® | ™ | “ | ” | &?! |
| ” | ' | ' | ' | _ | ÄÄä |
| | | | | | ÖÖö |

CLOSE

| | | | | | |
|---|---|---|---|---|-------|
| Â | Ä | Å | à | á | ABC |
| â | ã | ä | å | Æ | abc |
| æ | Ç | ç | È | É | 0-9,. |
| Ê | Ë | è | é | ê | &?! |
| ë | Ï | ì | í | Ð | ÄÄä |
| Ñ | ñ | Î | í | _ | ÖÖö |

CLOSE

| | | | | | |
|---|---|---|---|---|-------|
| Ô | Ö | Ø | ò | ó | ABC |
| ô | ö | ø | û | ü | abc |
| ù | ú | û | ü | Þ | 0-9,. |
| ƒ | ß | ı | İ | Ń | &?! |
| Ö | ö | œ | æ | ƒ | ÄÄä |
| t | z | ' | _ | | ÖÖö |

CLOSE

АБ

| | | | | | |
|---|---|---|---|---|-------|
| А | Б | В | Г | Д | АБВ |
| Е | Ё | Ж | З | И | ЧШЩ |
| Й | К | Л | М | Н | абв |
| О | П | Р | С | Т | чшщ |
| У | Ф | Х | Ц | — | 0-9,. |

CLOSE

| | | | | | |
|---|---|----|---|---|-------|
| Ч | Ш | Щ | Ь | Ы | АБВ |
| Ь | Э | Ю | Я | Г | ЧШЩ |
| Е | І | Ї | Ў | Ң | абв |
| Ң | Ј | ЈЬ | Ң | Ц | чшщ |
| Ғ | Ѕ | Ў | — | | 0-9,. |

CLOSE

| | | | | | |
|---|---|---|---|---|-------|
| а | б | в | г | д | АБВ |
| е | ё | ж | з | и | ЧШЩ |
| й | к | л | м | н | абв |
| о | п | р | с | т | чшщ |
| у | ф | х | ц | — | 0-9,. |

CLOSE

| | | | | | |
|---|---|----|---|---|-------|
| Ч | Ш | Щ | Ь | Ы | АБВ |
| Ь | Э | Ю | Я | Г | ЧШЩ |
| Е | І | Ї | Ў | Ң | абв |
| Ң | Ј | ЈЬ | Ң | Ц | чшщ |
| Ғ | Ѕ | Ў | — | | 0-9,. |

CLOSE

| | | | | | |
|---|---|---|---|---|-------|
| 0 | 1 | 2 | 3 | 4 | АБВ |
| 5 | 6 | 7 | 8 | 9 | ЧШЩ |
| — | . | , | & | ? | абв |
| ! | (|) | / | ' | чшщ |
| — | | | | | 0-9,. |

CLOSE

あア年組
0~9&?! *

Category names
Nombres de las categorías
Noms des catégories

Characters belonging to each category above
Caracteres pertenecientes a cada una de las categorías anteriores
Caractères appartenant à chaque catégorie ci-dessus

| | | | | | |
|---|---|---|---|---|--------------|
| あ | か | さ | た | な | あいう |
| は | ま | や | ら | わ | アイウ |
| あ | い | う | え | お | 0-9&?! 年組 |
| あ | い | う | え | お | — |

CLOSE H V

Hiragana characters: One of the character sets of Japanese.
Caracteres Hiragana: uno de los grupos de caracteres del japonés.
Caractères Hiragana : l'un des jeux de caractères japonais.

Katakana characters: One of the character sets of Japanese.
Caracteres Katakana: uno de los grupos de caracteres del japonés.
Caractères Katakana: l'un des jeux de caractères japonais.

Arabic numerals, Japanese Kanji numerals
Números arábigos, números Kanji japoneses
Chiffres arabes, chiffres Kanji japonais

Kanji characters often used in daily life / symbols.
Los caracteres Kanji se utilizan a menudo en la vida diaria / como símbolos.
Les caractères Kanji sont souvent utilisés dans la vie de tous les jours / symboles.

Horizontal
Horizontal
Horizontal
Vertical
Vertical
Vertical

| | | | | | |
|---|---|---|---|---|--------------|
| ア | カ | サ | タ | ナ | あいう |
| ハ | マ | ヤ | ラ | ワ | アイウ |
| ア | イ | ウ | エ | オ | 0-9&?! 年組 |
| ア | イ | ウ | エ | オ | — |

CLOSE H V

| | | | | | |
|---|---|---|---|---|--------------|
| 0 | 1 | 2 | 3 | 4 | あいう |
| 5 | 6 | 7 | 8 | 9 | アイウ |
| 0 | — | 二 | 三 | 四 | 0-9&?! 年組 |
| 五 | 六 | 七 | 八 | 九 | — |
| + | & | ? | ! | (| — |
|) | — | | | | — |

CLOSE H V

| | | | | | |
|---|---|---|---|---|--------------|
| 生 | 年 | 月 | 日 | 才 | あいう |
| 小 | 中 | 学 | 校 | 組 | アイウ |
| 火 | 水 | 木 | 金 | 土 | 0-9&?! 年組 |
| | | | | — | — |

CLOSE H V

* Japanese characters
* Caracteres japoneses
* Caractères japonais

English
Spanish
French
882-D01
Printed in Taiwan



XF3651-001