

USER GUIDE

TRIMBLE® S7 TOTAL STATION

Revision A
Part number 57011045
April 2015



Legal Notices

Geospatial Division,
10368 Westmoor Drive
Westminster CO 80021
USA
www.trimble.com

Copyright and trademarks

© 2015, Trimble Navigation Limited. All rights reserved.

Autolock, Tracklight, Trimble and the Globe & Triangle logo are trademarks of Trimble Navigation Limited, registered in the United States Patent and Trademark Office and other countries. FineLock, MagDrive, MultiTrack, SurePoint, SureScan and VISION are trademarks of Trimble Navigation Limited.

Microsoft and Windows are either registered trademarks or trademarks of Microsoft Corporation in the United States and/or other countries.

The Bluetooth word mark and logos are owned by the Bluetooth SIG, Inc. and any use of such marks by Trimble Navigation Limited is under license.

All other trademarks are the property of their respective owners.

Release Notice

This is the April 2015 release Revision A of the Trimble S7 Total Station user guide, part number 57011045. It applies to the Trimble S7 Total Station.

The following limited warranties give you specific legal rights. You may have others, which vary from state/jurisdiction to state/jurisdiction.

Product Warranty Information

For applicable product warranty information, please refer to the Warranty Card included with this Trimble product, or consult your Trimble dealer.

Regulatory Information

For applicable regulatory information, please refer to the Trimble S5, S7, S9, S9 HP Total Station Regulatory Information Document included with this Trimble product, or consult your Trimble dealer.

Registration

To receive information regarding updates and new products, please contact your local dealer or visit www.trimble.com/register. Upon registration you may select the newsletter, upgrade or new product information you desire.

Safety Information

Laser Safety

Before using the instrument, make sure that you understand this user guide, as well as all equipment and job site safety requirements.

This equipment has been tested and found to comply with IEC 60825-1 2007, 21 CFR 1040.10, and 1040.11 except for deviations pursuant to Laser Notice No. 50, dated June 24, 2007.



WARNING – Use of controls or adjustments or performance of procedures other than those specified herein may result in hazardous LED or laser radiation exposure. As with any bright light source, such as the sun, electric welding arcs or arc lamps, common sense applies. DO NOT look into the laser aperture when the laser is on. For further information regarding safe use of lasers, refer to the IEC 60825-1 June 24, 2007.

Queries

Address any questions you may have about laser safety to:

Trimble Navigation Limited

5475 Kellenburger Road

Dayton, OH USA 45424-1099

Attention: Laser Safety Officer, Quality Assurance Group

Phone (937) 233-8921 ext 824 or (800) 538-7800

Fax (937) 233-9661

Apertures

The figure below describes the apertures of the Trimble® S7 Total Station.

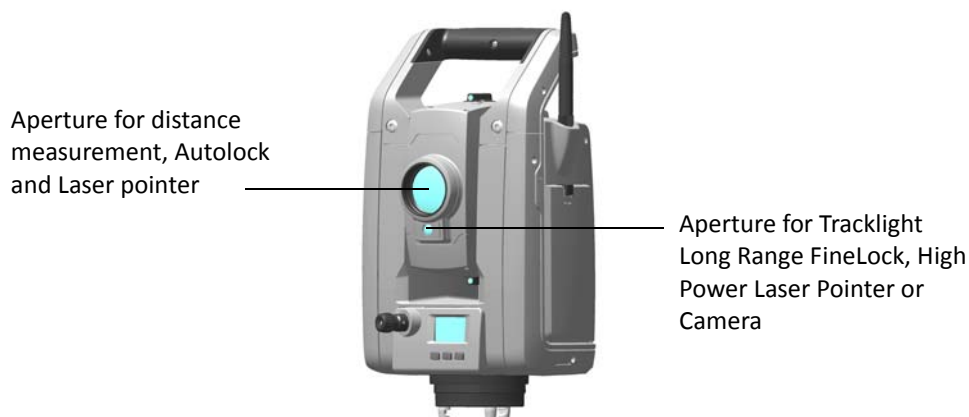
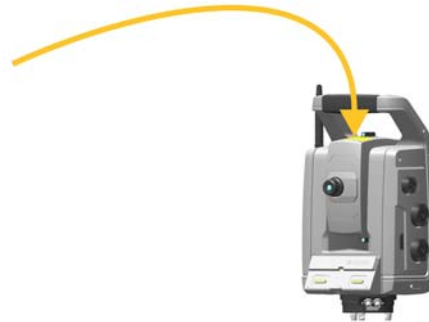

Figure 1.1 Trimble S7 apertures

Trimble S7 Total Station

The Trimble S7 Total Station is a CLASS 2 LASER PRODUCT



The instrument contains visible and invisible laser sources

A laser diode for the distance measuring function operating at 905 nm (infrared, non-visible light), with a beam divergence of 0.4×0.8 mrad and an output power of <1.1 mW, while the emission is coaxial with the telescope, this mode operates in LASER CLASS 1.

A laser diode for laser pointer function operating at 630 - 680 nm (visible light), with a beam divergence of 0.3 mrad and an output power of <0.7 mW, while the emission is coaxial with the telescope, this mode operates in LASER CLASS 2.

A laser diode for Autolock[®] function operating at 785 nm (infrared, non-visible light), with a beam divergence of 38.5 mrad and an out put power of <0.35 mW, while the emission is coaxial with the telescope, this mode operates in LASER CLASS 1.

The Autolock laser diode and the Long Range FineLock laser diode can not operate at the same time.

When operating in prism mode with Autolock and/or distance measurement the accessible radiation does not exceed the limits of LASER CLASS 1.

Battery Safety

-
-  **WARNING** – Do not damage the rechargeable Lithium-ion battery. A damaged battery can cause an explosion or fire, and can result in personal injury and/or property damage. To prevent injury or damage:
- Do not use or charge the battery if it appears to be damaged. Signs of damage include, but are not limited to, discoloration, warping, and leaking battery fluid.
 - Do not expose the battery to fire, high temperature, or direct sunlight.
 - Do not immerse the battery in water.
 - Do not use or store the battery inside a vehicle during hot weather.
 - Do not drop or puncture the battery.
 - Do not open the battery or short-circuit its contacts.
-

-  **WARNING** – Avoid contact with the rechargeable Lithium-ion battery if it appears to be leaking. Battery fluid is corrosive, and contact with it can result in personal injury and/or property damage. To prevent injury or damage:
- If the battery leaks, avoid contact with the battery fluid.
 - If battery fluid gets into your eyes, immediately rinse your eyes with clean water and seek medical attention. Do not rub your eyes!
 - If battery fluid gets onto your skin or clothing, immediately use clean water to wash off the battery fluid.
-

-  **WARNING** – Charge and use the rechargeable Lithium-ion battery only in strict accordance with the instructions. Charging or using the battery in unauthorized equipment can cause an explosion or fire, and can result in personal injury and/or equipment damage. To prevent injury or damage:
- Do not charge or use the battery if it appears to be damaged or leaking.
 - Charge the Lithium-ion battery only in a Trimble product that is specified to charge it. Be sure to follow all instructions that are provided with the battery charger.
 - Discontinue charging a battery that gives off extreme heat or a burning odor.
 - Use the battery only in Trimble equipment that is specified to use it.
 - Use the battery only for its intended use and according to the instructions in the product documentation.
-

Transport

The instrument is equipped with a Locate 2 Protect (L2P) module that communicates via cellular technology, it is therefore necessary to check local regulations before transporting this instrument by air.

-
-  **WARNING** – Make sure that the L2P module is inactivated during air transport.
-

For information how to inactivate the L2P module see Inactivate L2P Module, page 82

ESD Information

The instrument has been tested and complies with ESD regulations.

When a Trimble CU Controller is not attached to the instrument the Panel Attachment Cover P/N 50014012 should be attached for full ESD and environmental protection.

The Panel Attachment Cover is attached and detached to and from the panel attachment in the same way as the Trimble CU Controller. See *Attaching the TCU to the Instrument* on page 63 and See *Detaching the TCU* on page 64



Figure 1.2 Panel Attachment Cover P/N 50014012

Contents

| | |
|---------------------------------------------------------------|------------|
| Legal Notices | II |
| Safety Information | III |
| Laser Safety | III |
| Queries | III |
| Apertures | III |
| Trimble S7 Total Station | IV |
| Battery Safety | V |
| Transport | V |
| ESD Information | VI |
| 1 Introduction | 1 |
| Welcome | 2 |
| Related Information | 3 |
| Technical Assistance | 3 |
| Your Comments | 3 |
| Registration | 3 |
| 2 Inspection, Care & Maintenance | 4 |
| Inspecting the Container | 5 |
| Instrument Case | 5 |
| Storing the Carrying Straps | 6 |
| Attaching the Accessory Case to the Instrument Case | 8 |
| Care and Maintenance | 9 |
| Cleaning | 9 |
| Getting Rid of Moisture | 9 |
| Storage | 9 |
| Transport | 10 |
| Air Transport | 10 |
| Servicing | 10 |
| 3 Getting Started | 11 |
| Battery Safety | 12 |
| Battery | 13 |
| Disposal | 13 |
| Charging the Battery | 14 |
| Five Slot Charger | 14 |
| Dual Slot Charger | 16 |
| Connecting an Internal Battery | 19 |
| Connecting an External Battery | 19 |
| Instrument Description | 21 |
| Trigger Key | 22 |
| Face 2 Display | 23 |
| Optical Plummet | 24 |
| Handle | 24 |
| 4 Set up | 27 |
| Setup | 28 |
| Setup Stability | 28 |
| Measurement Stability | 29 |
| Starting the Instrument | 29 |
| Leveling | 30 |
| Instrument Setup | 30 |

| | |
|------------------------------------------------------------|-----------|
| Security | 31 |
| PIN Code | 31 |
| PUK Code | 36 |
| Radio Settings | 37 |
| Bluetooth® Device Settings | 40 |
| Reference HA. | 42 |
| Adjustments Menu | 42 |
| Firmware Version Information | 52 |
| Service Info. | 53 |
| Select Language | 53 |
| Exit Menu. | 54 |
| The Laser Pointer | 54 |
| Aligning the Laser Pointer. | 54 |
| Adjusting the Laser Pointer | 55 |
| Measuring the Instrument Height | 58 |
| Adjusting the Optical Plummet | 60 |
| Pre Measurement Check List | 61 |
| Connecting a Controller | 62 |
| Trimble CU Controller | 62 |
| Trimble TSC3 Controller | 67 |
| 5 Instrument Technology | 69 |
| Angle Measuring Technology | 70 |
| Correction for Mislevelment | 70 |
| Correction for Collimation Errors. | 70 |
| Correction for Trunnion Axis Tilt | 71 |
| Averaging Measurements to Reduce Sighting Errors | 72 |
| Distance Measuring Technology | 72 |
| Beam Divergence | 73 |
| Autolock Technology | 75 |
| FineLock™ Technology. | 77 |
| Aiming | 78 |
| How to Check Aiming | 79 |
| Tracklight | 79 |
| Trimble VISION™ Technology | 80 |
| SureScan Technology | 81 |
| Locate2Protect Technology | 82 |
| Airplane Mode | 82 |
| Servo Technology | 83 |
| Position Servo | 83 |
| Focus Servo. | 84 |
| Power Management. | 84 |
| Stand Alone | 84 |
| Instrument with Trimble CU Connected | 85 |
| Battery Low Message | 86 |
| External Communication | 86 |
| Communication (Com) Connector | 86 |
| USB Connector | 86 |
| 6 Instrument Accessories | 88 |
| Trimble Multi Battery Adapter | 89 |
| Trimble Standard Rod | 90 |
| Trimble Target ID. | 91 |
| Trimble MultiTrack™ Target. | 94 |
| Features | 94 |
| Measures | 95 |

| | |
|-------------------------------------------------------------|-----|
| Fitting and Removing the Battery | .95 |
| Specification Label | .96 |
| Trimble Active Track 360 Target | .97 |
| Features | .97 |
| Measures | .98 |
| Inserting the battery. | .98 |
| Turn on the Target | .99 |
| Select ID Channel | .99 |
| Attach and Detach | 100 |
| Trimble Robotic Holder | 101 |
| Power Management. | 102 |
| Attaching a Battery | 103 |
| Detaching a Battery | 104 |
| Attaching a Trimble CU | 105 |
| Detaching a Trimble CU | 106 |
| Attaching the Trimble Robotic Holder to the Rod | 107 |
| Detaching the Trimble Robotic Holder from the Rod | 108 |
| Radio | 108 |
| Internal Radio | 108 |
| External Radio 2.4 GHz | 109 |
| Attaching the Battery | 109 |
| Detaching the Battery | 110 |
| Radio Antenna Extension Kit | 112 |

Introduction

In this chapter:

- Welcome
- Related Information
- Technical Assistance
- Your Comments
- Registration

Welcome

Welcome to the Trimble S7 Total Station user guide. This manual describes how to setup and use the Trimble S7 Total Station. Even if you have used an optical total station before, Trimble recommends that you spend some time reading this manual to learn about the special features of this product.



Trimble S7 Total Station

Through out this user guide the Trimble S7 Total Station will be referred to as the instrument.

Related Information

For more information about this product, please visit our web site at:

www.trimble.com

Technical Assistance

If you have a problem and cannot find the information you need in the product documentation, **contact your local Distributor**. Alternatively, request technical support using the Trimble web site at:

www.trimble.com

Your Comments

Your feedback about the supporting documentation helps us to improve it with each revision.

E-mail your comments to ReaderFeedback@trimble.com.

Registration

To receive information regarding updates and new products please register on the Trimble web site.

www.trimble.com/register

Inspection, Care & Maintenance

In this chapter:

- Inspecting the Container
- Instrument Case
- Care and Maintenance
- Transport
- Servicing

Inspecting the Container

Inspect the shipping container. If the container arrives in poor condition, examine the equipment for visible damage. If damage is found, immediately notify the carrier and your Trimble sales representative. Keep the container and the packing material for the carrier to inspect.

Instrument Case

When unpacking the instrument, check that all ordered items are received. Below is an example of where all items can be placed in the instrument case. See Figure 2.1.



Figure 2.1 Position of items in the instrument case

Note – Some of the items described in figure 2.1 are optional and not all of the items are delivered with the instrument.

| Item | Description |
|------|-------------------------------------------------------------------------------------------------------------------------------------------------------------------------------------------------------------------------------------------------------------------------------------------------------------------------------|
| 1 | Trimble S7 Total Station instrument |
| 2 | Tribrach |
| 3 | Trimble Active Track 360 Target (Not included with all models) |
| 4 | Instrument case with carrying straps |
| 5 | Rain cover |
| 6 | Tool for handle (Torx T30 key) |
| 7 | Tools for tribrach and optical plummet |
| 8 | Instrument case keys (2x) |
| 9 | Trimble S5, S7, S9, S9 HP Total Station Quick Start Guide, Trimble S5, S7, S9, S9 HP Total Station Regulatory Information Document, Locate 2 Protect Activation Card, Warranty Activation Card, Extended Warranty Card and Trimble Active Track 360 Target Quick Start Guide (If Trimble Active Track 360 Target is included) |
| 10 | Laser pointer adjustment tool |
| 11 | Reflective foil target |
| 12 | Laser pointer adjustment target (Type of target depends on distance meter type) |
| 13 | Lens rain cover |



CAUTION – If the instrument is equipped with the optional DIN adapter for DIN tribrach, then the DIN tribrach must be removed before the instrument is placed in the instrument case. The DIN standard is mostly used in the German market.



CAUTION – When shipping an instrument, make sure that the Trimble CU is not attached to the instrument. Place the Trimble CU in its own compartment in the transport case to avoid damage to the instrument. See [Figure 2.1](#)

Storing the Carrying Straps

When you are not using the carrying straps, you can store them in the carrying strap compartment on the instrument case.



Tip – Put the waist straps into the carrying strap compartment first, before the shoulder straps.

To take out and use the carrying straps:

1. Press the compartment lid lock downward and open the carrying strap compartment. See Figure 2.2

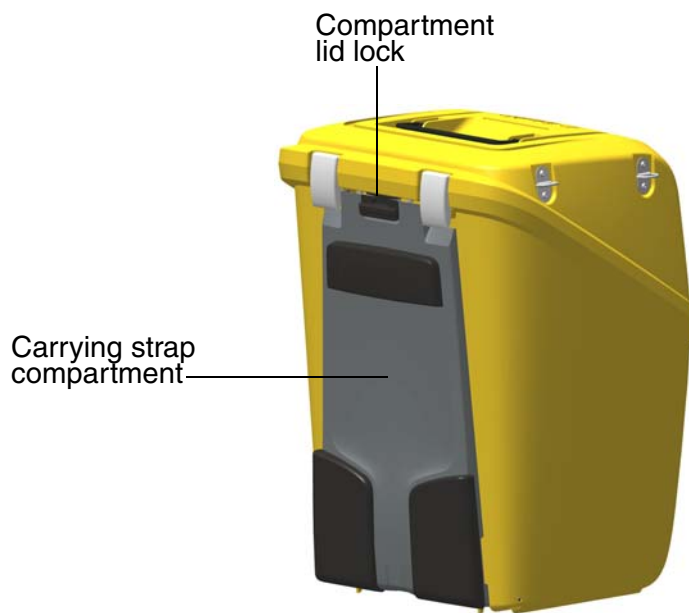

Figure 2.2 Instrument case with the carrying straps inside the compartment

2. Lift the straps from the compartment. The straps are already attached to the instrument case. See Figure 2.3



Figure 2.3 Fitting the carrying straps

3. Close the compartment lid, making sure that you do not jam the carrying straps. See Figure 2.4



Figure 2.4 Instrument case with the carrying straps ready for use

Attaching the Accessory Case to the Instrument Case

The accessory case can be fitted on top of the instrument case for transport to a job site. Use straps (not included) as shown in Figure 2.5.

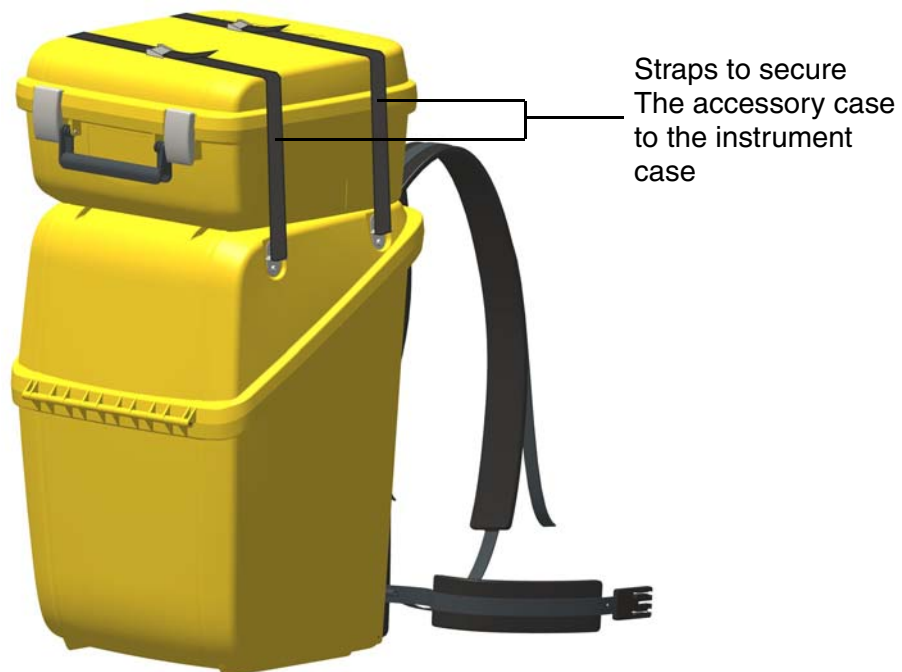

Figure 2.5 Accessory case fitted to the top of the instrument case

Care and Maintenance



WARNING – Do not remove the instrument cover from the instrument. The instrument is designed to withstand normal electromagnetic disturbance from the environment but it contains circuits that are sensitive to static electricity. If an unauthorized person opens the instrument cover, the function of the instrument is not guaranteed and the warranty is invalidated.

The instrument is designed and tested to withstand field conditions, but like all precision instruments, it requires care and maintenance. Take the following steps to get the best results from the instrument:

- Do not subject the equipment to rough jolts or careless treatment.
- Keep the lenses and reflectors clean. Use only lens paper or other material that is designed for cleaning optical equipment. As a cleaner, a solution of pure water and 20-30% 2-Propanol specified with evaporation residue <5mg/l.
- Keep the instrument protected and in an upright position, preferably in the instrument case.
- Do not carry the instrument while the instrument is mounted on a tripod. Doing so can damage the tribrach screws.
- Do not carry the instrument by the telescope barrel. Use the handle.
- When you need extremely precise measurements, make sure that the instrument has adapted to the surrounding temperature. Significant variations in instrument temperature can affect precision.

Cleaning



CAUTION – Never use strong detergents such as benzine or thinners on the instrument or the instrument case.

Be very careful when cleaning the instrument, especially when removing sand or dust from lenses and reflectors. Never use coarse or dirty cloth or hard paper. Trimble recommends that you use anti-static lens paper, a cotton wad, or a lens brush.

Getting Rid of Moisture

If the instrument has been used in damp weather, take the instrument indoors and remove the instrument from the instrument case. Leave the instrument to dry naturally. If condensation forms on the lenses, allow the moisture to evaporate naturally. Leave the carrying case open until all moisture has evaporated.

Storage

- Storage temperature range -40°C to +70°C (-40°F to 158°F) in a dry environment.
- Remove battery from the instrument before storage.

Transport

Always transport the instrument in a locked instrument case. For longer trips, transport the instrument in the instrument case and inside the original shipping container.

Always remove the internal battery during transport.

When transporting batteries, make sure to follow national and international rules and regulations. Contact your transport company before shipping.



CAUTION – When shipping an instrument, make sure that the Trimble CU is not attached to the instrument. Place the Trimble CU in its own compartment in the transport case to avoid damage to the instrument. See [Figure 2.1](#)

Air Transport

The instrument is equipped with a Locate 2 Protect (L2P) module that communicates via cellular technology, it is therefore necessary to check local regulations before transporting this instrument by air.



WARNING – Make sure that the L2P module is inactivated during air transport.

For information how to inactivate the L2P module see [Inactivate L2P Module, page 82](#)

Servicing

Note – *There are no user-serviceable parts on the instrument.*

Trimble recommends that you take the instrument to an authorized Trimble service workshop for service and calibration once a year. This is to guarantee that the specified accuracies are maintained.

When you send the instrument to a service center, clearly write the name of the sender and the receiver on the instrument case. If repairs are required, enclose a note in the instrument case. The note should clearly describe any fault or symptoms, and indicate that servicing is required.

Getting Started

In this chapter:

- Battery Safety
- Battery
- Charging the Battery
- Connecting an Internal Battery
- Connecting an External Battery
- Instrument Description

Battery Safety

Before charging or using a battery it is important that you read and understand the battery safety information.



WARNING – Do not damage the rechargeable Lithium-ion battery. A damaged battery can cause an explosion or fire, and can result in personal injury and/or property damage. To prevent injury or damage:

- Do not use or charge the battery if it appears to be damaged. Signs of damage include, but are not limited to, discoloration, warping, and leaking battery fluid.
 - Do not expose the battery to fire, high temperature, or direct sunlight.
 - Do not immerse the battery in water.
 - Do not use or store the battery inside a vehicle during hot weather.
 - Do not drop or puncture the battery.
 - Do not open the battery or short-circuit its contacts.
-



WARNING – Avoid contact with the rechargeable Lithium-ion battery if it appears to be leaking. Battery fluid is corrosive, and contact with it can result in personal injury and/or property damage. To prevent injury or damage:

- If the battery leaks, avoid contact with the battery fluid.
 - If battery fluid gets into your eyes, immediately rinse your eyes with clean water and seek medical attention. Do not rub your eyes!
 - If battery fluid gets onto your skin or clothing, immediately use clean water to wash off the battery fluid.
-



WARNING – Charge and use the rechargeable Lithium-ion battery only in strict accordance with the instructions. Charging or using the battery in unauthorized equipment can cause an explosion or fire, and can result in personal injury and/or equipment damage. To prevent injury or damage:

- Do not charge or use the battery if it appears to be damaged or leaking.
 - Charge the Lithium-ion battery only in a Trimble product that is specified to charge it. Be sure to follow all instructions that are provided with the battery charger.
 - Discontinue charging a battery that gives off extreme heat or a burning odor.
 - Use the battery only in Trimble equipment that is specified to use it.
 - Use the battery only for its intended use and according to the instructions in the product documentation.
-

Battery

The instrument battery is a rechargeable Lithium-ion battery.

The battery has an integrated power gauge that will display the condition of the battery. The power gauge is activated by pressing the button on the battery. See Figure 3.1



Figure 3.1 Battery power gauge and button

When you press the button, four LEDs on the instrument battery show the power level. Each LED corresponds to a power level of 25% so that when the power level is at 100%, all four LEDs are lit. If the battery is completely discharged, all LEDs are unlit.

When the button is pushed and all the LEDs flash, the battery needs to be reconditioned in the battery charger, See [Conditioning the Battery](#) on page 15.

When the battery capacity is between 0 and 10% one LED is flashing. A battery with a flashing LED might not be able to start an instrument or a Trimble CU. If started, with a battery with a flashing LED, the operating time will be between 5 and 15 minutes.

Disposal

- Before disposal, discharge the battery.
- Dispose of the used battery in an environmentally sensitive manner, according to local and national regulations.

Charging the Battery

The battery is supplied partially charged. Charge the battery completely before using it for the first time.

 **Tip** – The Five slot charger and Dual slot charger can also be used to charge the Trimble 7.4 V Li-Ion batteries used in the Trimble MultiTrack™ Target and the Trimble Active Track 360 Target, see Figure 3.2

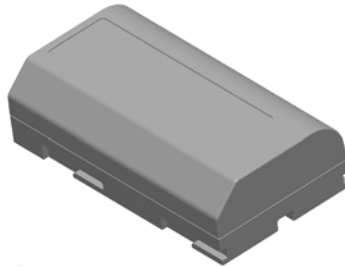

Figure 3.2 Trimble 7.4 V Li-Ion battery

Five Slot Charger

The charger operates between 0 °C (32 °F) and 40 °C (104 °F). Charging a battery at temperatures in the range of 0 °C (32 °F) to 5 °C (41 °F) will take longer than charging at room temperature.



CAUTION – Ensure that nothing obstructs the vents in the back of the charger. The bottom of the charger is hot during charging.

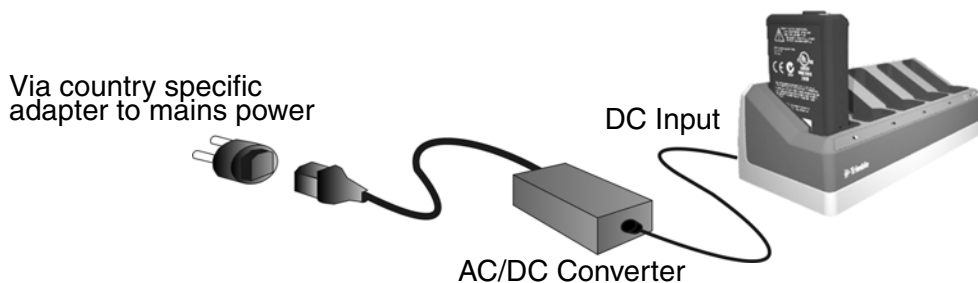

Figure 3.3 Five Slot charger

To charge the battery:

1. Ensure that the vents in the back of the charger are unobstructed.
2. Place the charger on a hard, flat and level surface, to ensure that there is airflow under the charger.
3. To apply power to the charger, use the AC to DC converter. The charger scans the slots for a battery. The green light flashes on the slot that is being scanned.
4. Place the battery in any of the slots. For an explanation of the LED display, see page 16.

- Charging takes approximately 3 hours per battery at room temperature. If several batteries are charging in the battery charger, the batteries will be charged sequentially, from left to right.

Leave a deeply discharged or shorted battery overnight in the charger to attempt to revive the battery. A shorted battery is typically revived as soon as the slot is scanned. If the Amber LED turns off, the battery is revived. If the Amber LED stays on, the battery is no longer functional and needs to be replaced.

Conditioning the Battery

Charge the battery as described above. Ensure that the vents in the back of the charger are unobstructed and that the charger is on a flat and level surface.

If the Amber LED for a slot is flashing, the battery occupying this slot requires conditioning.

A battery that has been subjected to 20 consecutive incomplete charge/discharge cycles requires conditioning and will trigger the conditioning-required indicator. A full charge/discharge cycle is defined as one that uses more than 90% of the battery capacity. A battery requires conditioning if the power gauge (a count of the battery capacity) in the battery is misreading the battery capacity by more than 8%. The battery is still safe to use, but the power gauge may no longer be accurate which may decrease the battery run time in the field.

Using all the battery capacity before charging will reset the indicator. The charger also has the capability to perform a conditioning cycle.

To condition the battery

- Press the conditioning button on the back of the charger. Amber LEDs become solid, and all green LEDs start to flash. Release the conditioning button. See [Figure 3.4](#)

In the conditioning mode, the charger discharges any battery that requires conditioning and then charges it.

Conditioning a single battery can take up to 24 hours. Conditioning five batteries can take up to 60 hours. Trimble recommends that you condition the battery or batteries on a weekend.



CAUTION – The bottom of the charger is hot during conditioning. Do not touch the bottom plate.

- If you press the conditioning button again when conditioning is in progress, you cancel conditioning. To succeed, a conditioning cycle must be uninterrupted.



Figure 3.4 Battery charger conditioning button

Battery Charger LED Behavior

Table 3.1 Five Slot Battery Charger LED Behavior

| Status | Amber LED | Green LED |
|--------------------------------------------|-----------|-----------|
| No battery detected (or battery defective) | ON | OFF |
| Battery detected (charging not started) | | |
| Conditioning not required | OFF | OFF |
| Conditioning required | FLASHING | OFF |
| Charging in progress | | |
| Conditioning not required | OFF | FLASHING |
| Conditioning required | FLASHING | FLASHING |
| Conditioning in progress | ON | FLASHING |
| Conditioning done (battery fully charged) | ON | ON |
| Battery fully charged | | |
| Conditioning not required | OFF | ON |
| Conditioning required | FLASHING | ON |

Dual Slot Charger

The charger operates between 0 °C (32 °F) and 40 °C (104 °F). Charging a battery at temperatures in the range of 0 °C (32 °F) to 5 °C (41 °F) will take longer than charging at room temperature.



CAUTION – Ensure that nothing obstructs the vents in the back and bottom of the charger.



Figure 3.5 Dual Slot Charger

To charge the battery:

1. Ensure that the vents in the back and bottom of the charger are unobstructed.
2. Place the charger on a hard, flat and level surface, to ensure that there is airflow under the charger.

3. To apply power to the charger, use the AC to DC converter or 12V cigarette plug. The charger scans the slots for a battery.
4. Place the battery in any of the slots. The Red light turns off (can take up to 5s). For an explanation of the LED display, see LED Status Indicator.
5. Charging takes approximately 3 hours per battery at room temperature. If two batteries are placed in the charger the batteries will be charged one at a time.

Leave a deeply discharged or shorted battery overnight in the charger to attempt to revive the battery. A shorted battery is typically revived as soon as the slot is scanned. If the Red LED turns off, the battery is revived. If the Red LED stays on, the battery is no longer functional and needs to be replaced.

Conditioning the Battery



CAUTION – The bottom of the charger is hot during conditioning. Do not touch the bottom plate.



CAUTION – Ensure that nothing obstructs the vents in the back and bottom of the charger.

After a number of incomplete charge/discharge cycles the gas gauge in the Smart Battery gets inaccurate. The battery is still safe to use, but the power gauge may no longer be accurate which may decrease the battery run time in the field. Then a conditioning is required. This is a cycle of:

Charge battery completely

Discharge the battery until the voltage is below the low-end conditioning threshold Charge battery again

The need for conditioning is read out from the battery by the charger and indicated by a blinking Red LED. Conditioning starts when the conditioning button is pressed by the user. There is one button for each slot. Only the batteries requiring a conditioning can be conditioned.

To condition the battery:

1. Press the conditioning button under the battery. Red LED become solid and the green LED start to flash. Release the conditioning button.
2. If you remove the battery while conditioning is in progress, you cancel conditioning. To succeed, a conditioning cycle must be uninterrupted.

Conditioning a single battery can take up to 24 hours. It is recommended that you condition the battery or batteries on a weekend.

LED Status Indicator

Beside each slot are two LED indicators (Red + Green) to display the battery status.

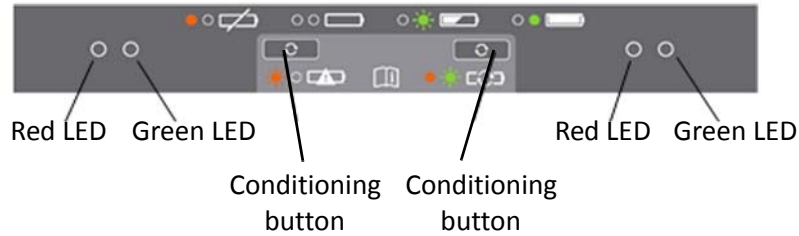

Figure 3.6 Dual Slot Charger control panel

Table 3.2 Five Slot Battery Charger LED Behavior

| Status | Red LED | Green LED |
|-----------------------------------------------|----------------------|----------------------|
| No battery detected (or battery defective) | ON | OFF |
| Battery detected (charging not started) | | |
| Conditioning not required | OFF | OFF |
| Conditioning required | FLASHING | OFF |
| Charging in progress | | |
| Conditioning not required | OFF | FLASHING |
| Conditioning required | FLASHING | FLASHING |
| Over/Under -temperature (Charge is inhibited) | One flash every 2.5s | FLASHING |
| Conditioning in progress | ON | FLASHING |
| Conditioning done (battery fully charged) | ON | ON |
| Battery fully charged | | |
| Conditioning not required | OFF | ON |
| Conditioning required | FLASHING | ON |
| Power supply over/under -voltage | OFF | One flash every 2.5s |

For more information regarding the Dual Slot Charger, please refer to the documentation delivered with the charger.

Connecting an Internal Battery

The instrument internal battery fits into the battery compartment on the side of the instrument. This battery can easily be removed and replaced. To insert the battery:

1. Open the battery compartment hatch by pressing the lock release button.
2. Slide the battery into the battery compartment with the battery connectors positioned towards the top of the instrument. See Figure 3.7



Figure 3.7 Inserting and/or removing the internal battery

Connecting an External Battery

The instrument has two external connectors in the base of the instrument. Both connectors can be used to connect an external power supply to the instrument. External power can be provided by one of the following:

- Multi Battery Adapter, see [Trimble Multi Battery Adapter](#), page 89
- Car battery, via cable with croc clips or via cable with cigarette lighter connector



CAUTION – Use only the gray cables with 6-pin Hirose connectors from Trimble when connecting a cable to the instrument and Multi Battery Adapter.

 **Tip** – When connecting the cable to the instrument, keep the Trimble logo on the connector upward.

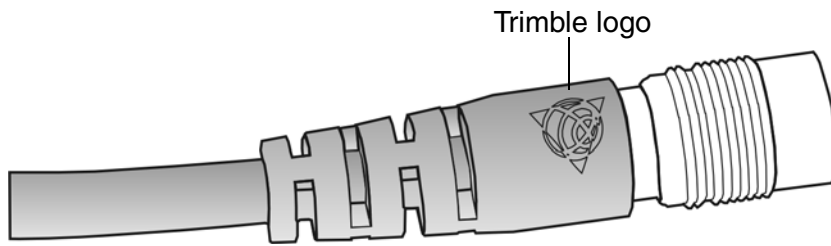

Instrument Description

This section describes the instrument controls. Trimble recommends that you take some time to familiarize yourself with the names and the locations of the controls. See [Figure 3.8](#) and [Figure 3.9](#)

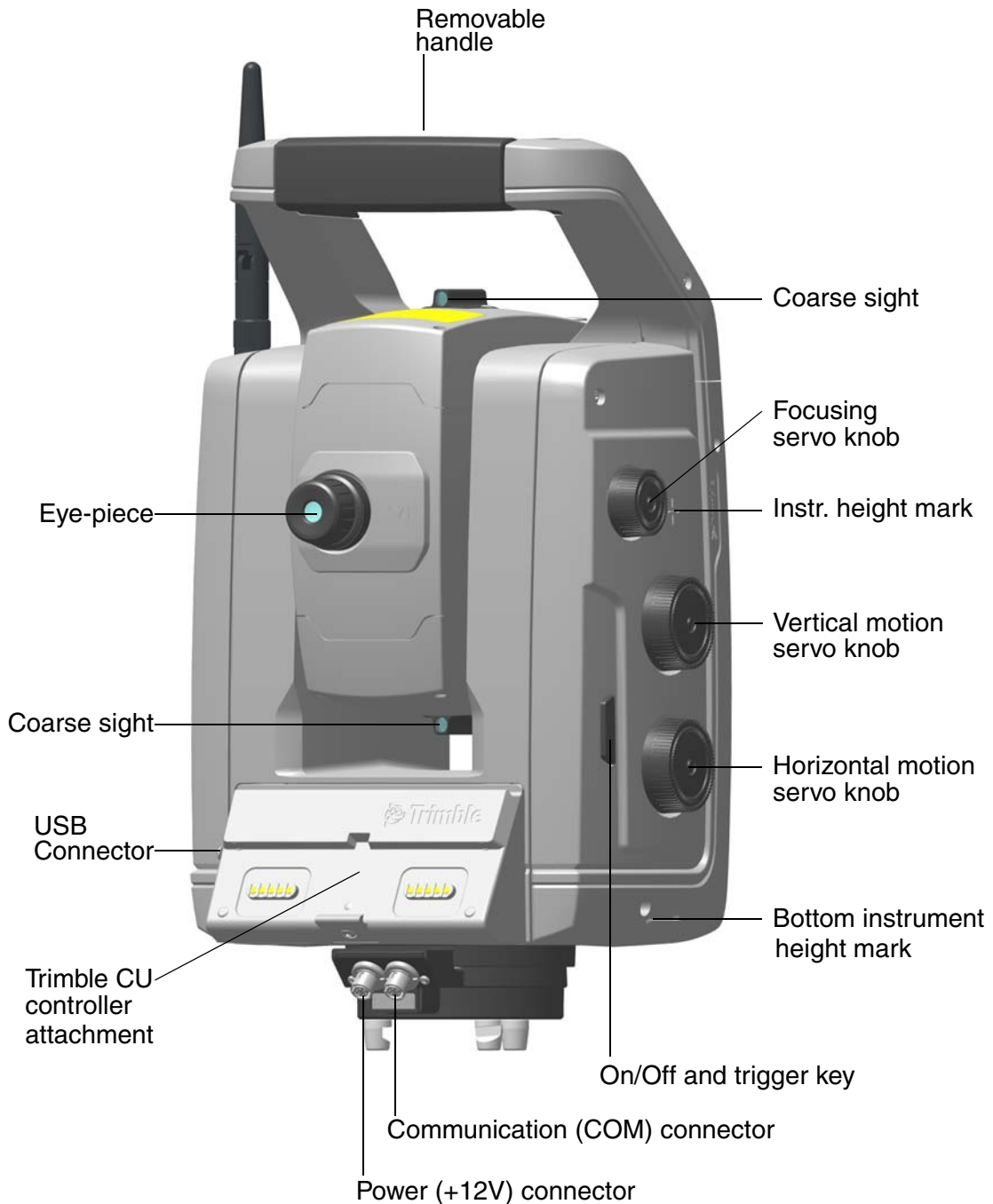

Figure 3.8 Operator's view of the instrument

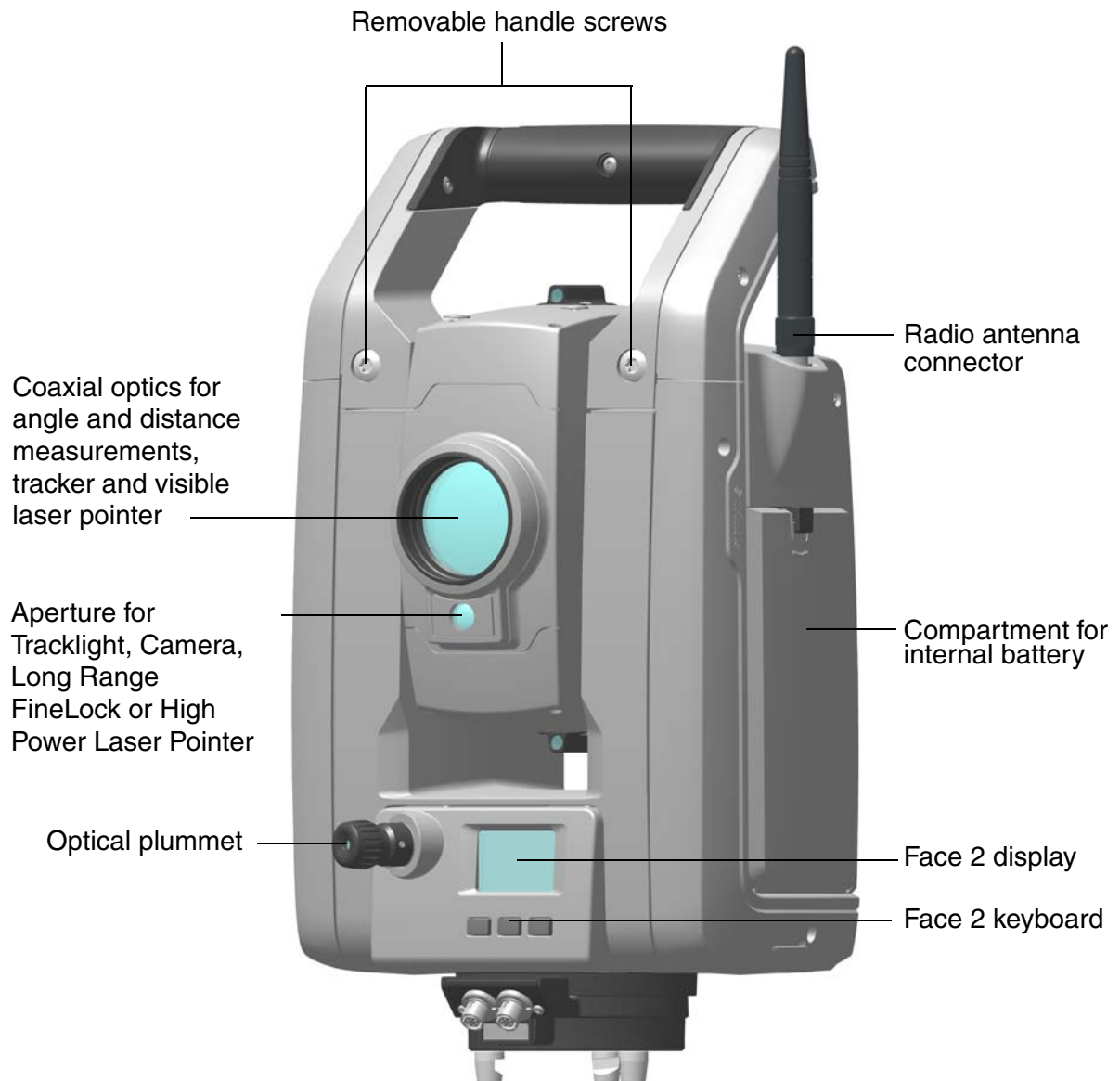

Figure 3.9 Front view of the instrument

Trigger Key

When there is no Trimble CU attached to the instrument, the trigger key functions as an On/Off key. An LED in the trigger key indicates if the instrument is turned on. A solid light indicates on and a flashing light indicates suspend mode.

When there is a Trimble CU running a field application software connected to the instrument, the trigger key performs the same function as the Enter key on the Trimble CU.

Face 2 Display

The face 2 display is a graphical display with a built-in backlight, and three control buttons. See Figure 3.10

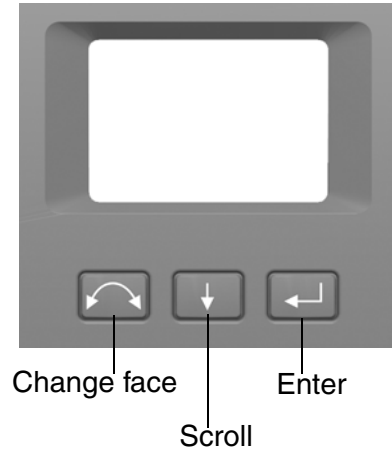

Figure 3.10 Face 2 display and keyboard

When a secondary function is available on a button, an icon appears at the bottom of the display. To access the secondary function, press and hold the appropriate key.

When a Trimble CU is attached to the instrument, the software running on the unit controls the face 2 display and keyboard, and determines which secondary functions are available. For details on how the software controls the face 2 display, refer to the field software documentation.

When there is no Trimble CU attached to the instrument, and you turn on the instrument using the trigger key, the face 2 display shows an electronic leveling screen. See Figure 3.11



Figure 3.11 Electronic leveling screen on the face 2 display

For information on how to access the compensator menu and instrument setup menu from the face 2 display and keyboard. See [Adjusting the Optical Plummet](#) on page 60.

Optical Plummet

The instrument is equipped with an optical plummet, which has 2x magnification and a focusing range of 0.5 m to infinity. The instrument can be positioned to an accuracy of 0.5 mm at 1.5 m over a ground mark.

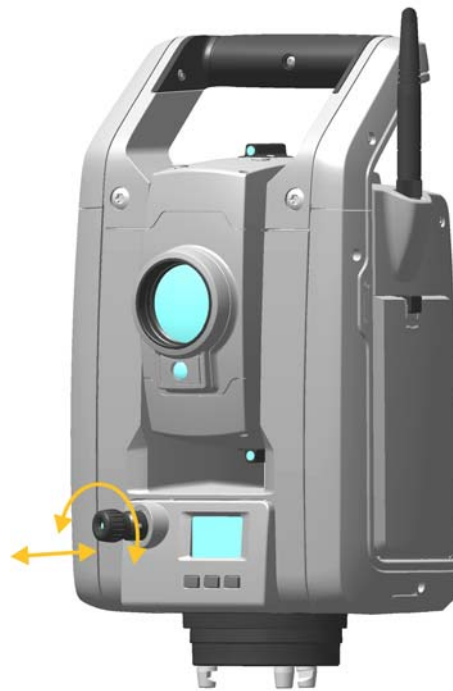

Figure 3.12 Optical plummet

As shown in Figure 3.12:

- To focus the crosshairs, rotate the eye-piece.
- To focus the optical plummet to the ground, push in or pull out the optical plummet.

For information on how to adjust the optical plummet. See [Adjusting the Optical Plummet](#) on page 60.

Handle

The handle on the instrument is detachable for measurements in confined spaces, or for instances where the handle obstructs the sighting line.

The instrument handle is placed so that it will not obscure measurements in the face 1 position, or restrict plumbing vertically beneath an overhead marker or sighting up a vertical shaft.

The handle can be removed by:

1. Unscrew the two Torx screws securing the handle to the instrument, use a T30 Torx key.
2. Slide the handle horizontally away from the front of the instrument. See Figure 3.13 and Figure 3.14



Figure 3.13 Removing the instrument handle



Figure 3.14 Detaching the instrument handle

Attaching the handle:

Attaching the handle is completed by reversing the above operations.



CAUTION – Make sure that the handle is firmly attached before you lift the instrument.

Set up

In this chapter:

- Setup
- Starting the Instrument
- Leveling
- Instrument Setup
- The Laser Pointer
- Measuring the Instrument Height
- Adjusting the Optical Plummet
- Pre Measurement Check List
- Attaching the TCU to the Instrument
- Detaching the TCU
- Trimble TSC3 Controller

Setup

An instrument setup with good measuring stability will increase the precision in the measurement result and allow you to utilize the measurement precision of the instrument to its full extent.

Setup Stability

When an instrument is setup it is important to consider the following:

1. Set tripod legs wide apart to increase the stability of the setup. A setup where one leg is placed on e.g asphalt and the other two on soil will still be a stable setup provided that the tripod legs are set wide enough. If it is not possible to set the tripod legs wide apart due to obstacles, then the tripod can be lowered to increase stability.

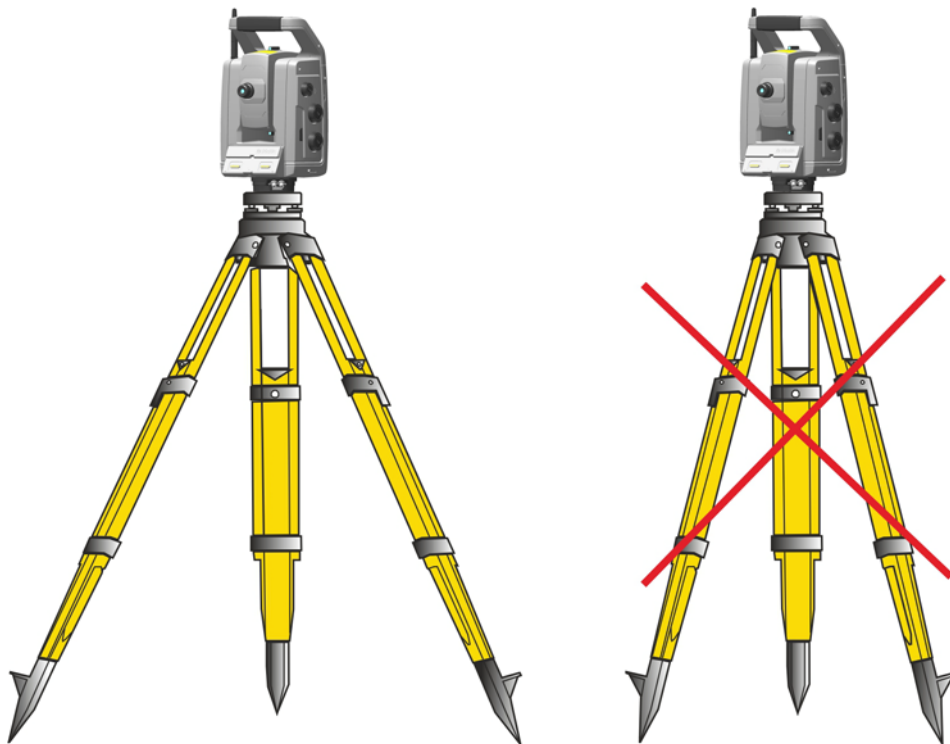

Figure 4.1 Correct instrument set up

2. Make sure that all the screws on the tripod and/or tribrach are tightened to avoid any play.
3. Any high quality tripod and tribrach can be used. However, Trimble strongly recommends the use of tripod heads made of steel, aluminum or similar material. Tripod heads of fiberglass or other composite materials are not recommended.

See [Servo Technology](#) on page 83 for more information.

Measurement Stability

Take into account that instruments require sufficient time to adjust to the ambient temperature. The following rule-of-thumb for a high precision measurement applies: Temperature difference in degree Celsius (°C) x 2 = duration in minutes required for the instrument to adjust to the new temperature.

Avoid sighting across fields with intense heat shimmer by sun light, e.g. at noon.

Starting the Instrument

Note – Before following any of the instructions below, put the instrument in the face 2 position, i.e. the telescope eyepiece and face 2 keyboard and display are pointing towards you.

The face 2 display menus described in this chapter can only be accessed when there is no Trimble CU attached, please remove the Trimble CU before starting the instrument.

Start the instrument by pressing the trigger key.

Once you start the instrument, the *Select Mode* menu appears in the face 2 display.

To go to Setup/Level press .

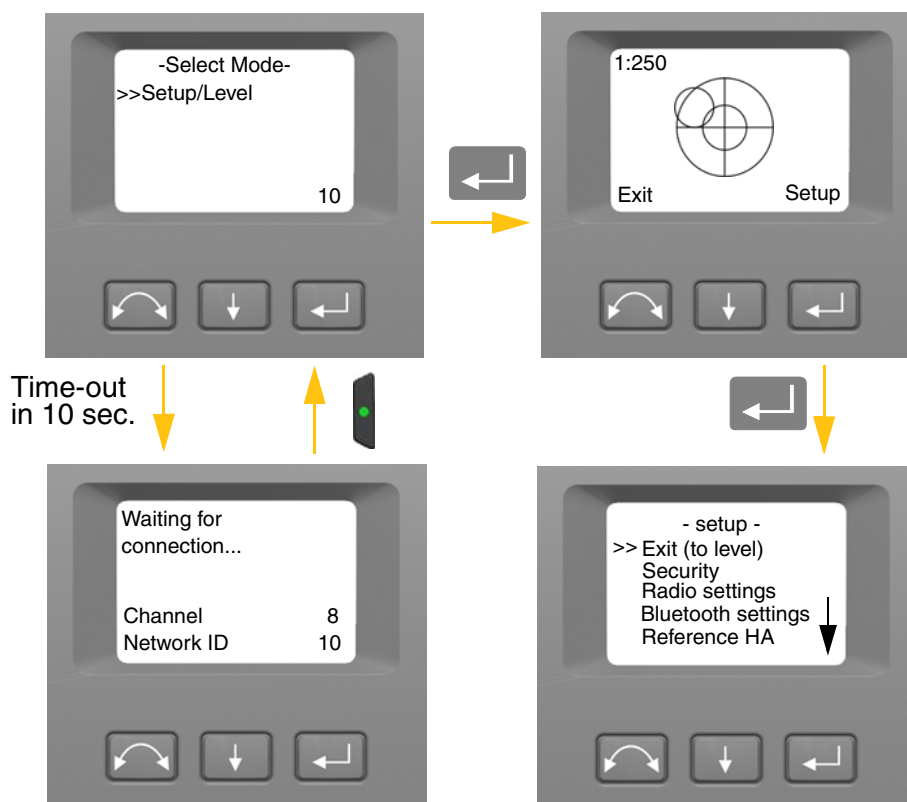

Note – If no selection is made within 10 seconds the instrument will go to suspend mode. To return to the select mode menu press the trigger key.

Leveling

Once you have selected Setup/Level, the face 2 display appears with the electronic bubble for leveling. If there is a Trimble CU attached, the Trimble CU software controls the face 2 display. Figure 4.2 shows the leveling process.

To toggle between a graphical or numerical display make a long press on .

To change the graphical displays sensitivity (zoom) make a short press on .

To accept and enter the *setup* menu press .

Note – Due to the high speed servo it is important to use a high quality tripod and tribrach.

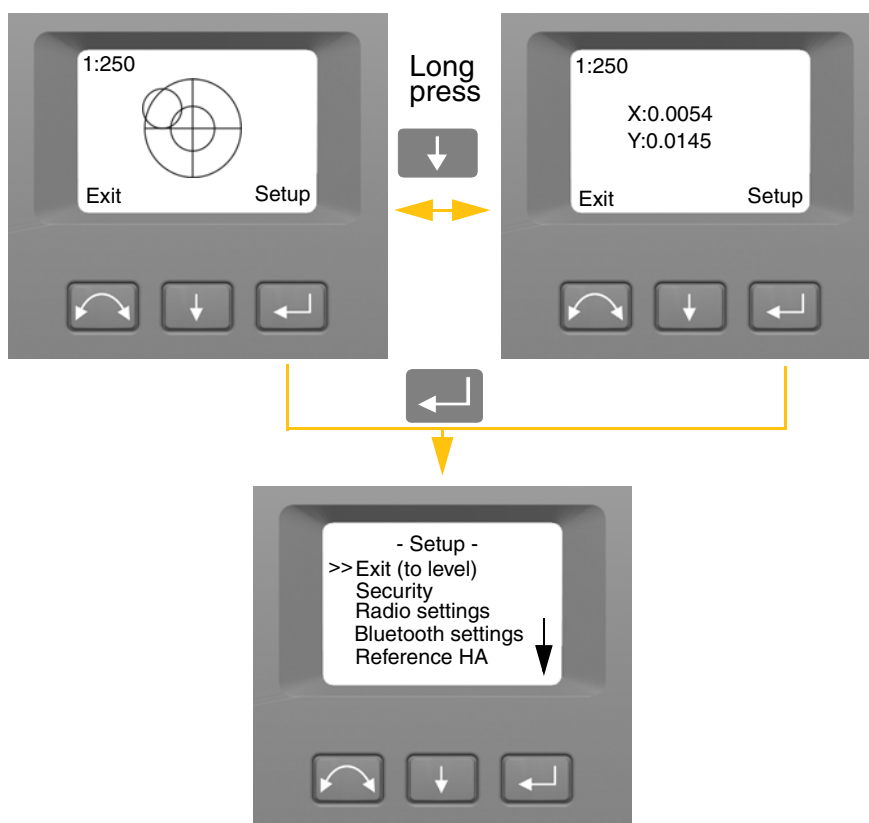



Figure 4.2 The leveling process

Note – If the instrument is inactive for longer than 300 seconds (5 minutes) it will go to suspend mode. See Power Management on page 84

Instrument Setup

With the face 2 display, you can access a number of instrument functions and routines without a Trimble CU attached:

In the leveling display select Setup by pressing , the *Setup* Menu appears:

Note – It is possible to access the instrument setup menu without leveling the instrument.

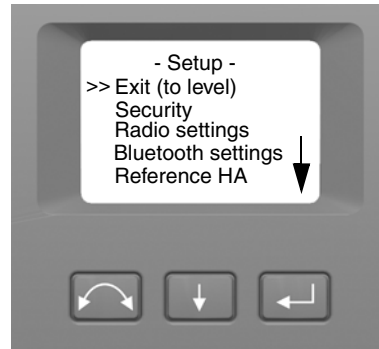

The instrument *Setup* menu is structured as follows:

- Exit (to level)
- Security settings, See Security on page 31
- Radio settings. See page 37.
- Bluetooth[®] device settings, See Bluetooth[®] Device Settings on page 40
- Reference Horizontal Angle. See page 42.
- Adjustments. See page 42.
 - Back
 - Compensator calibration. See page 42.
 - HA/VA and trunnion axis collimation. See page 44.
 - Tracker collimation. See page 48.
 - Laser pointer on/off. See page 50.
 - Autofocus calibration. See page 51
- Firmware version information. See page 52.
- Service info, See Service Info on page 53
- Language settings, See Select Language on page 53

Security

To avoid unauthorized use of the instrument a PIN/PUK security code can be activated by the user.

PIN Code









The PIN Code is a four digit code where each digit can be set between 0-9 e.g. “1234”. The PIN Code can be activated and changed by the user.

As default the PIN Code is set to “0000”. With this code set the security is not activated and the user will not be prompted to enter PIN Code at start up.

Note – *If the wrong code is entered more than 10 times, the instrument will be locked and the PUK Code needs to be entered.*

Activate or Change PIN Code

To activate the security PIN Code or change the PIN Code:

1. Press  to scroll to Security and then press .
2. Press  to scroll to Change PIN and then press .
3. Enter the current PIN Code. The underlined digit is selected for change.
 - a. Press  to change the digit to the correct number.
 - b. Press  to select the next digit.
 - c. When all four digits have been set to the correct PIN code press .
4. Enter the new PIN Code of your choice and press , follow the instructions 3a, 3b and 3c
5. To confirm the PIN Code press .

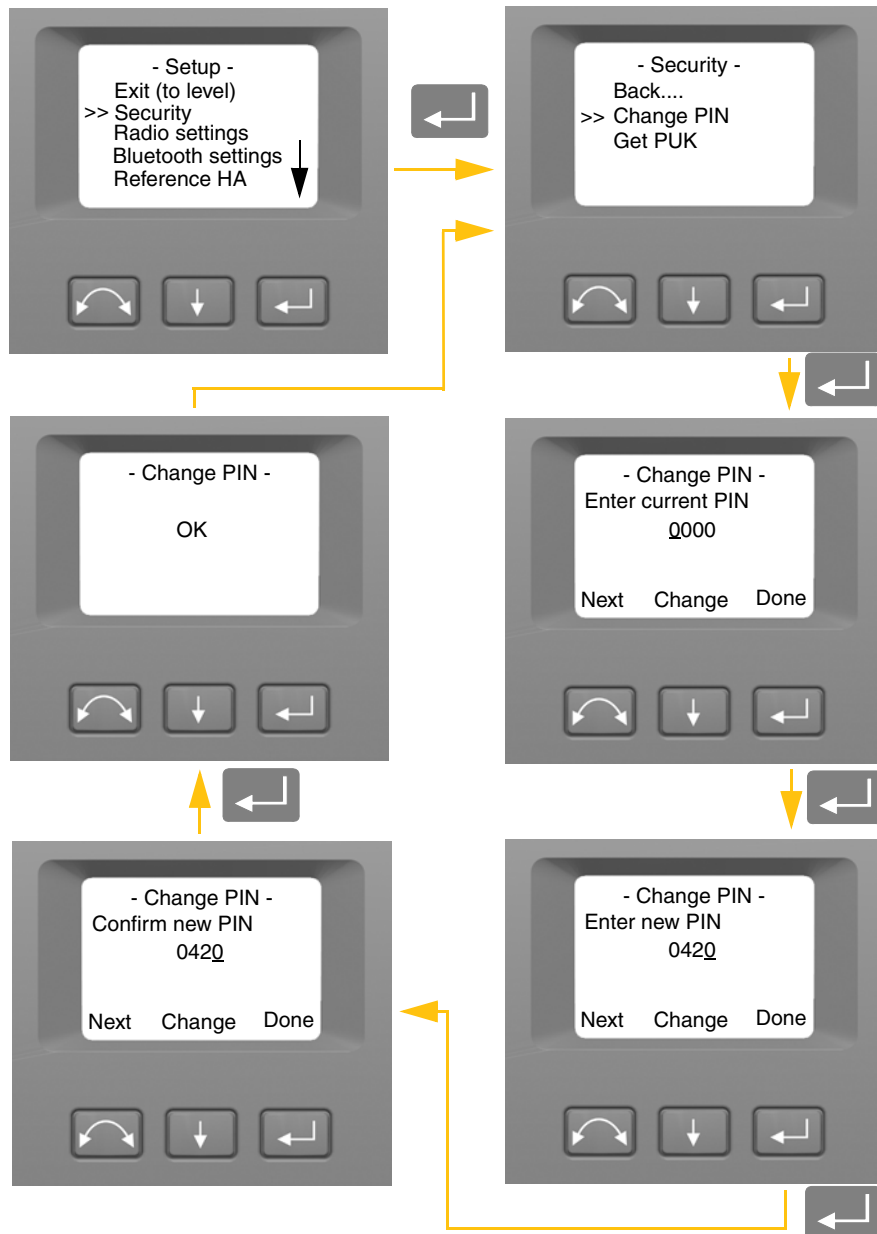

6. Press to scroll to Back.... and then press to return to the Setup menu.

Unlock Instrument With PIN Code

When the security PIN Code has been activated, the PIN Code needs to be entered at start up.

To unlock the instrument select Unlock Instrument and press .

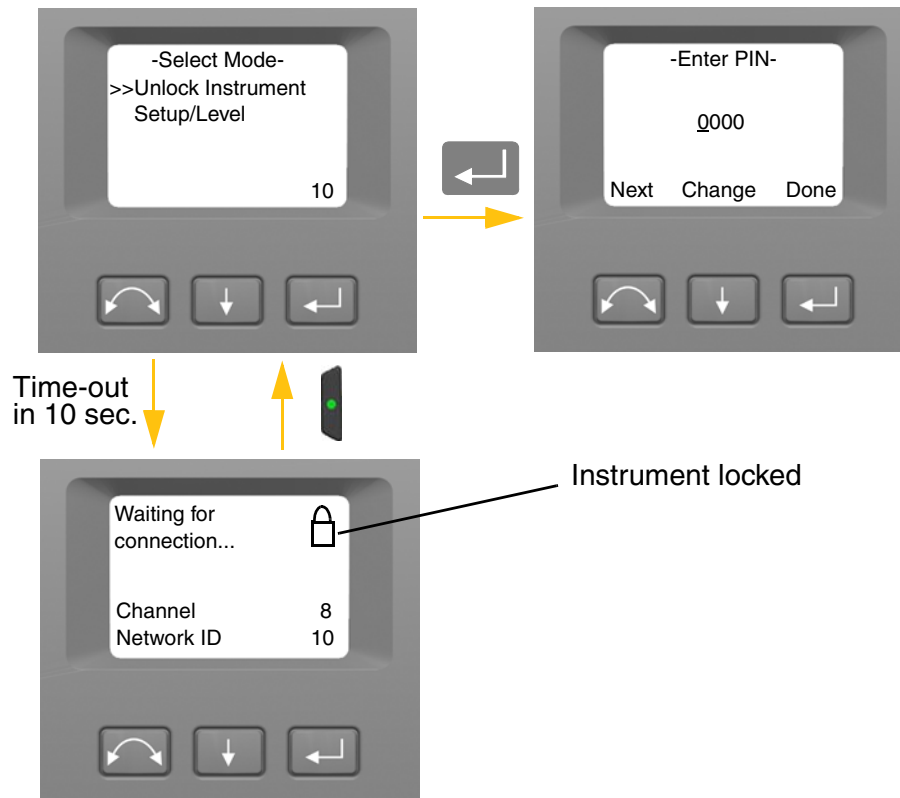

Note – If no selection is made within 10 seconds the instrument will go to suspend mode. To return to the select mode menu press the trigger key.

The PIN code is a four digit number. The underlined digit is selected for change.

1. Press to change the digit to the correct number
2. Press to select the next digit.
3. When all four digits have been set to the correct PIN code press .

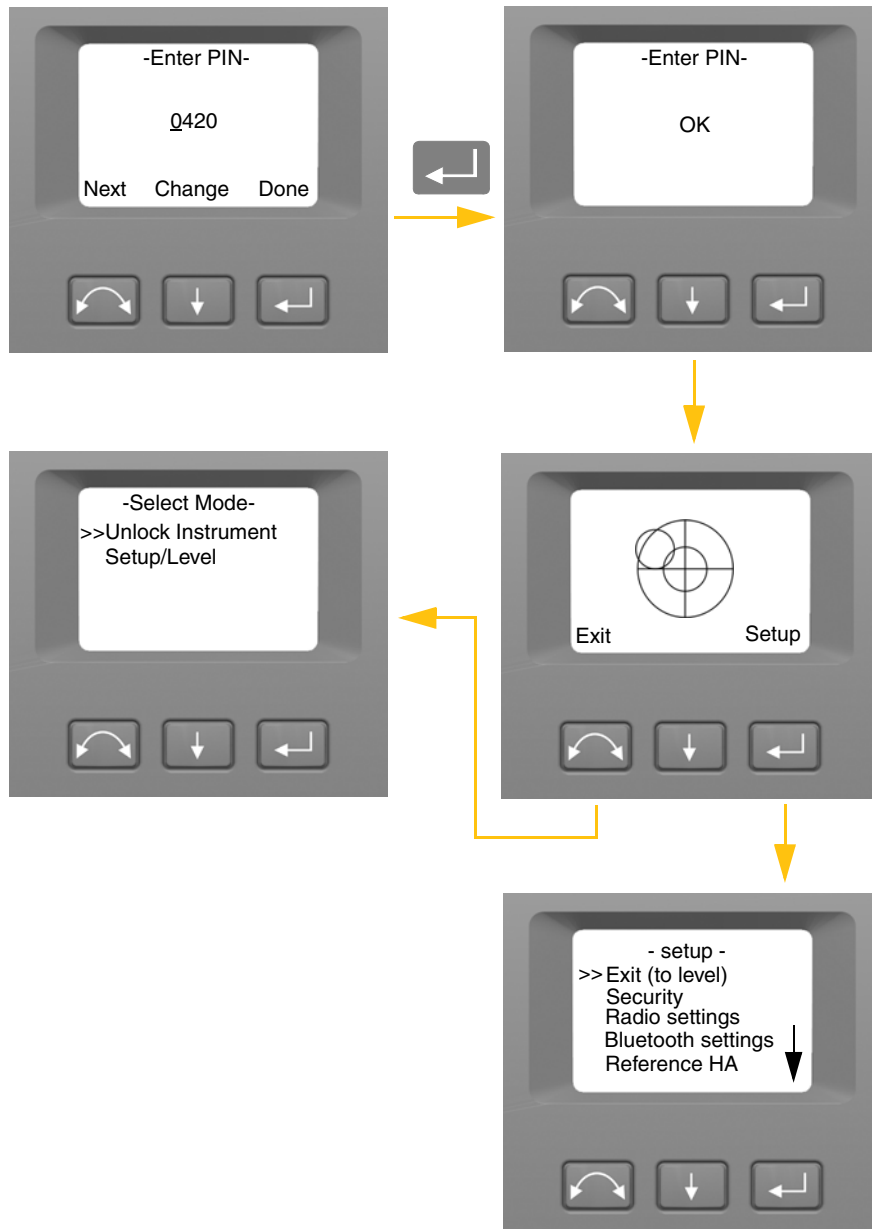

If the wrong PIN Code is entered more than ten times, you will be prompted to enter the PUK Code. When the correct PUK Code has been entered, the PIN Code will be reset to “0000”. This means that the PIN Code security will be inactivated.

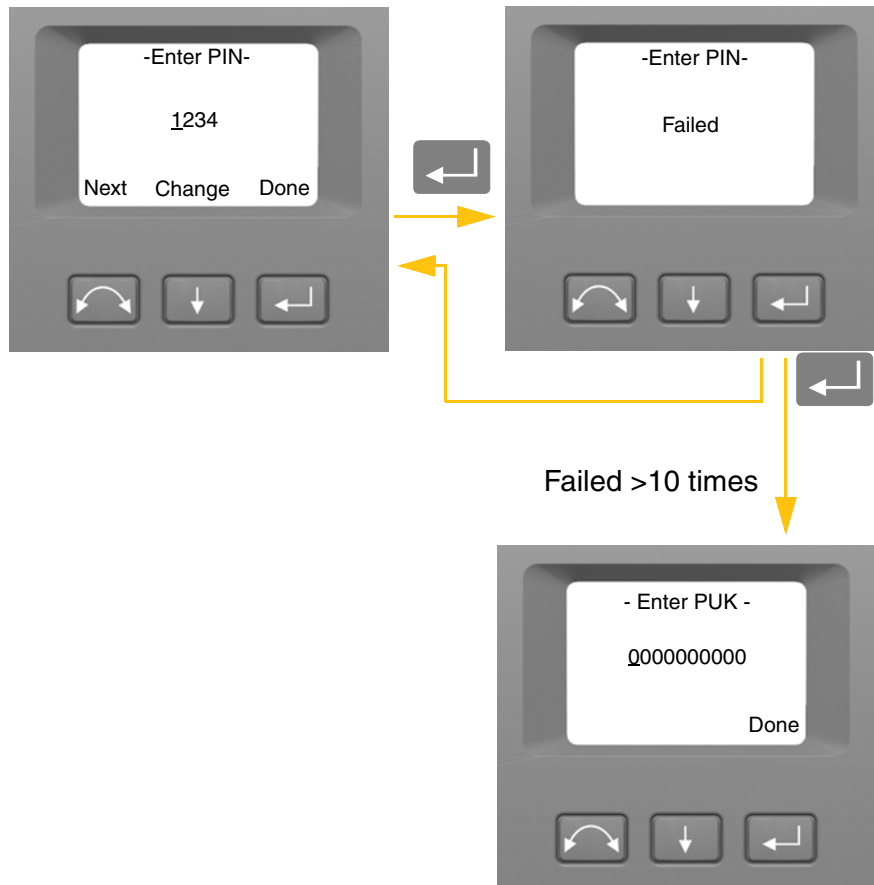

PUK Code





The PUK Code is a ten digit code where each digit is set between 0-9 e.g. "0123456789". The PUK Code can not be changed by the user.

The PUK Code is set at the factory. A document with the PUK Code is supplied to the user when the instrument is delivered. Please save this document in a safe place.

Note – If the PUK code has been lost, please contact your authorized Trimble distributor to retrieve the PUK code.

Note – The PUK Code is needed to unlock the instrument if wrong PIN Code has been entered more than ten times.

You can read out the PUK Code from the instrument:

1. Press  to scroll to Security and then press .
2. Press  to scroll to Get PUK and then press .
3. Press  to return to the Security menu.

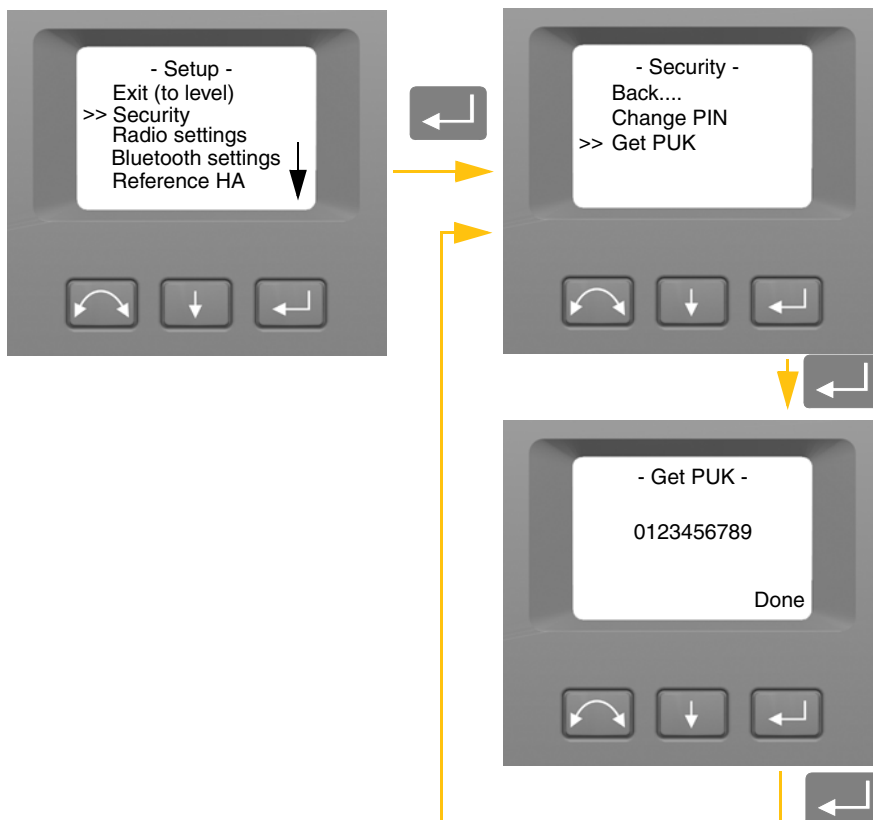

Radio Settings

In the *Radio settings* menu it is possible to set the radio channel and network ID number.

Set Radio Channel

1. Press to scroll to Radio settings and then press .
2. Press to scroll to Set radio channel and then press .

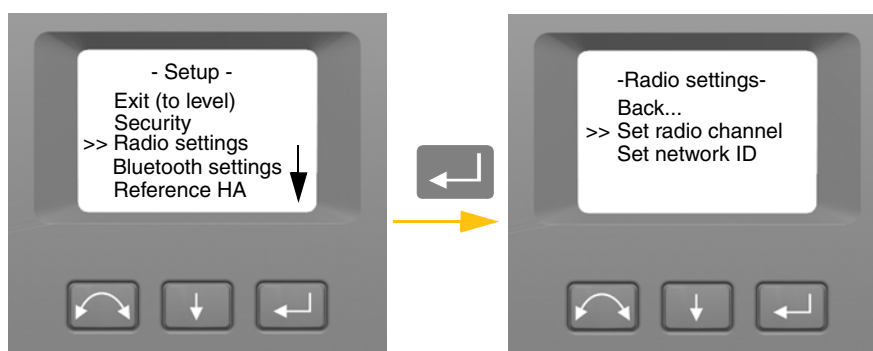

3. To change the radio channel number press to select Next and then press to change the channel number in the display.

Note – a short press on the enter key will increment the radio channel in increments of 1, pressing and holding the enter key, will increment the radio channel in steps of 10.

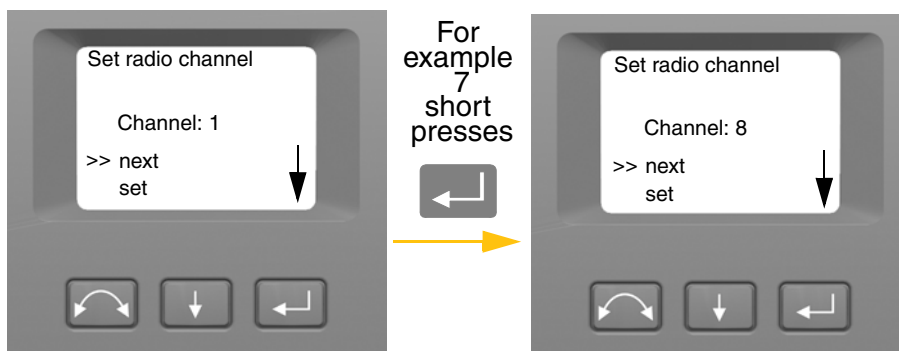



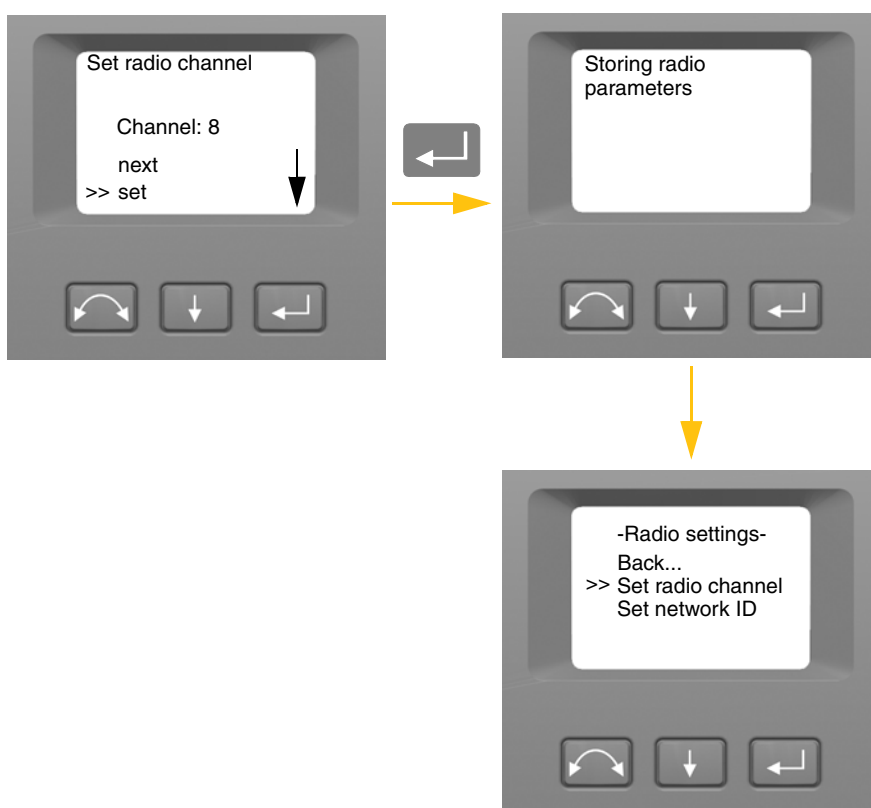

4. When you have found the channel number of your choice press to select Set and then press to store this channel number. You will then be returned to the Radio Settings menu.





5. If you want to cancel Press to select Cancel and then press to return to the Radio Settings menu.
6. To return to the *Setup* menu Press to scroll to Back and then press .

Set Network ID

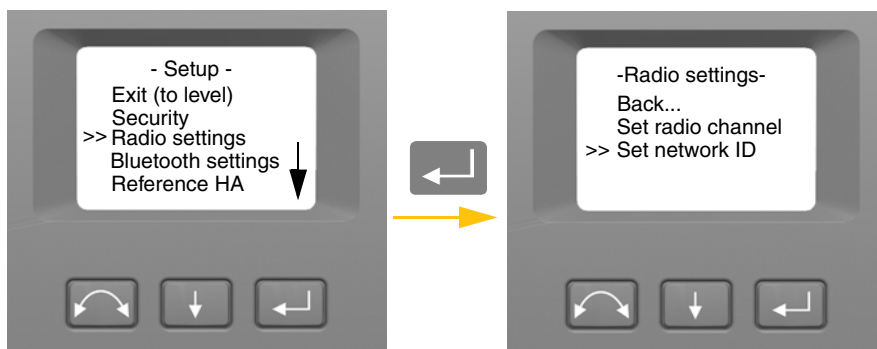
1. Press  to scroll to Radio settings and then press .
2. Press  to scroll to Set network ID and then press .





3. To change the network ID number press  to select Next and then press  to change the channel number in the display.

Note – a short press on the enter key will increment the network ID in increments of 1, pressing and holding the enter key, will increment the network ID in steps of 10.

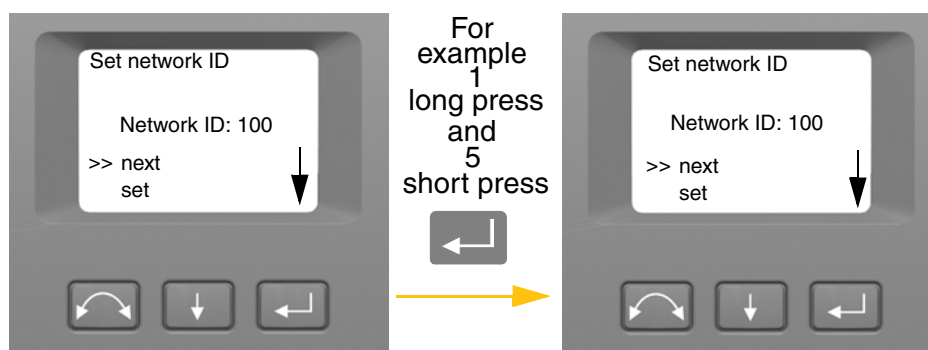
Network ID range 0-255



4. When you have found the network ID number of your choice press  to select Set and then press  to store this network ID number. You will then be returned to the Radio Settings menu.

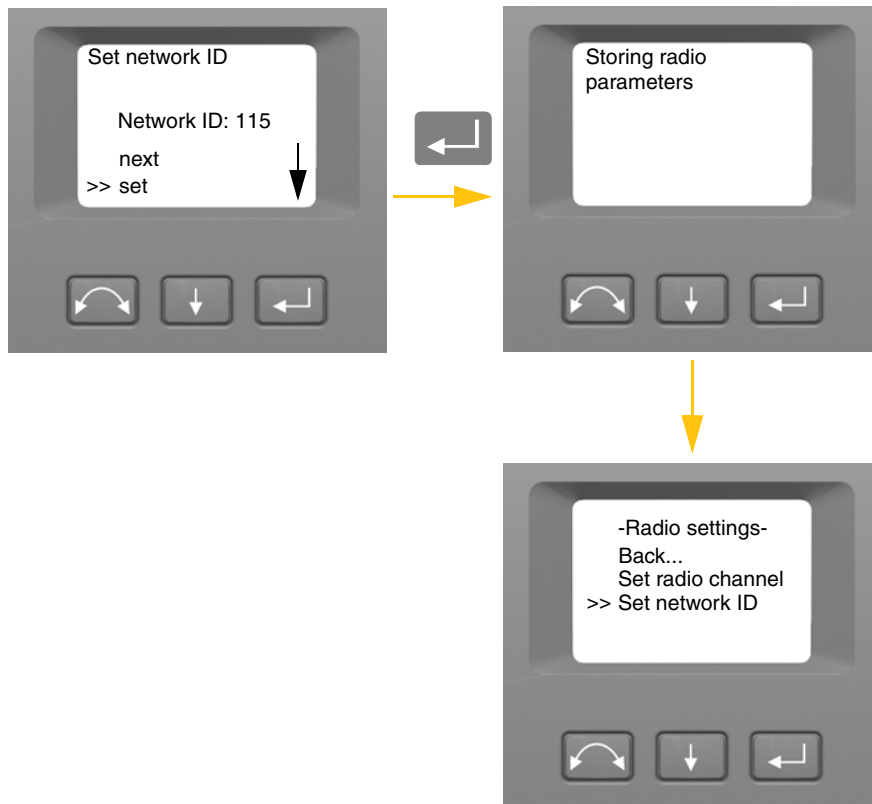

5. If you want to cancel Press to select Cancel and then press to return to the Radio Settings menu.
6. To return to the *Setup* menu Press to scroll to Back and then press .

Bluetooth[®] Device Settings

The instrument are equipped with Bluetooth wireless technology for cable free operations. The Bluetooth device antenna is located directly beneath the controller attachment plate in the face 1 position. In order to facilitate communications between a TSC3 controller or Tablet computer and the instrument, first enable the Bluetooth wireless technology option in the instrument. This is carried out as follows.



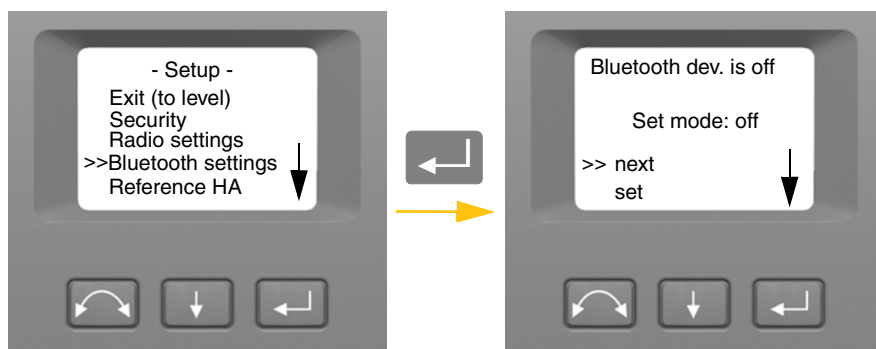

CAUTION – Before starting the Bluetooth device, make sure that the regulations of the country that you are working in allows the use of Bluetooth wireless technology.

1. Press  to scroll to Bluetooth settings then press .

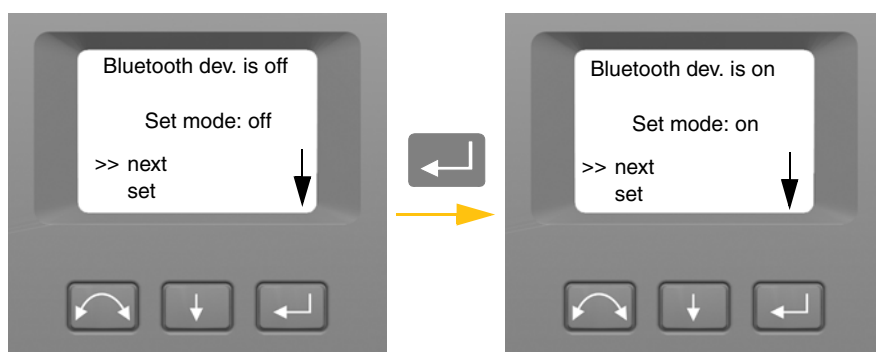

2. To change the Bluetooth device setting press  to select Next and then press  to select on or off



3. When you have found the setting of your choice press  to select Set and then press  to store this setting. You will then be returned to the setup menu.

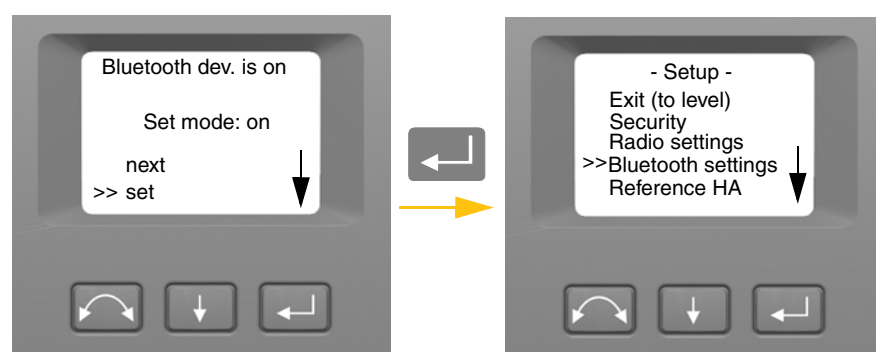

4. If you want to cancel Press  to select Cancel and then press  to return to the setup menu.



Note – At delivery the Bluetooth device is by default in off mode. Any change to this setting made by an operator will become the default setting until changed again.

Note – To reduce power consumption and extend operation time, Trimble recommends that the Bluetooth device is switched off when not in use.

Reference HA

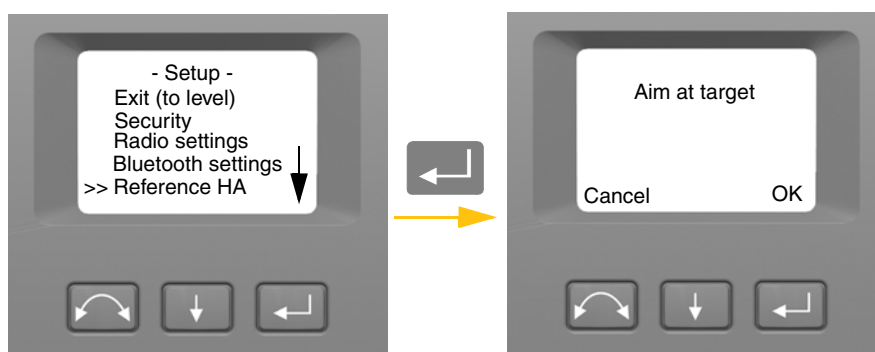
1. Press  to scroll to Reference HA and then press .



2. Aim the instrument in face 2 towards the target and then press enter  to set or  to cancel.

Since the instrument is aimed at the reference target in face 2 while setting the reference HA, the instrument's horizontal circle will be set to 180 degrees or 200 grads. This makes the reference HA 0 degrees or grads in face 1.

The *Setup* menu appears.

Adjustments Menu

The *adjustments* menu contains all the instrument collimation and calibration routines.

- Press  to scroll to Adjustments and then press .

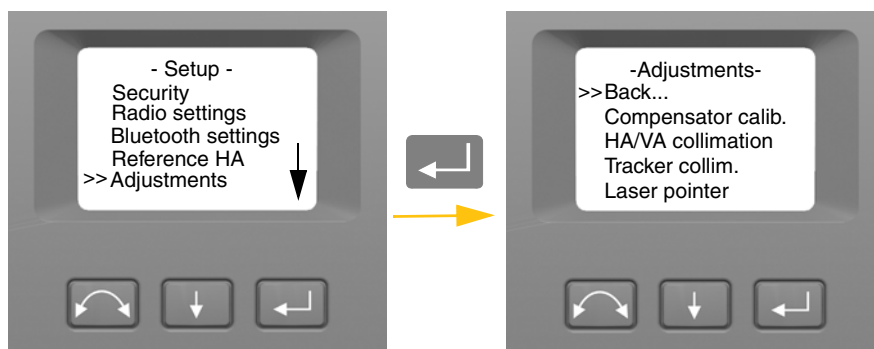

Compensator Calibration



To calibrate the compensator, the instrument needs to be in perfect balance. After calibration the compensator sensor will automatically adjust and allow for changes in that balance caused by the presence of a Trimble CU controller or the absence of an internal battery.

To minimize imbalance in the instrument:

- Do not have the Trimble CU mounted on the instrument.

- An internal battery must be present in the battery compartment.
- The instrument handle must be attached.
- The instrument will automatically position the telescope and distance unit for best balance.

To start the compensator calibration:

1. Level the instrument. The instrument will automatically check if the compensator is within range before the calibration is started.
2. Press  to scroll to Compensator calib. and then press .
3. Follow the instructions in the display. [Figure 4.3](#).

Note – *Trimble recommends that you regularly carry out a compensator calibration, particularly when measuring during high temperature variations and where the highest measurement accuracy is required.*

The calibration process involves the instrument automatically reading the compensator value at a series of predetermined positions through the full rotation of the instrument. The process takes approximately one minute to complete. During the process the instrument should be on a stable platform, free from vibration and untouched by the user.

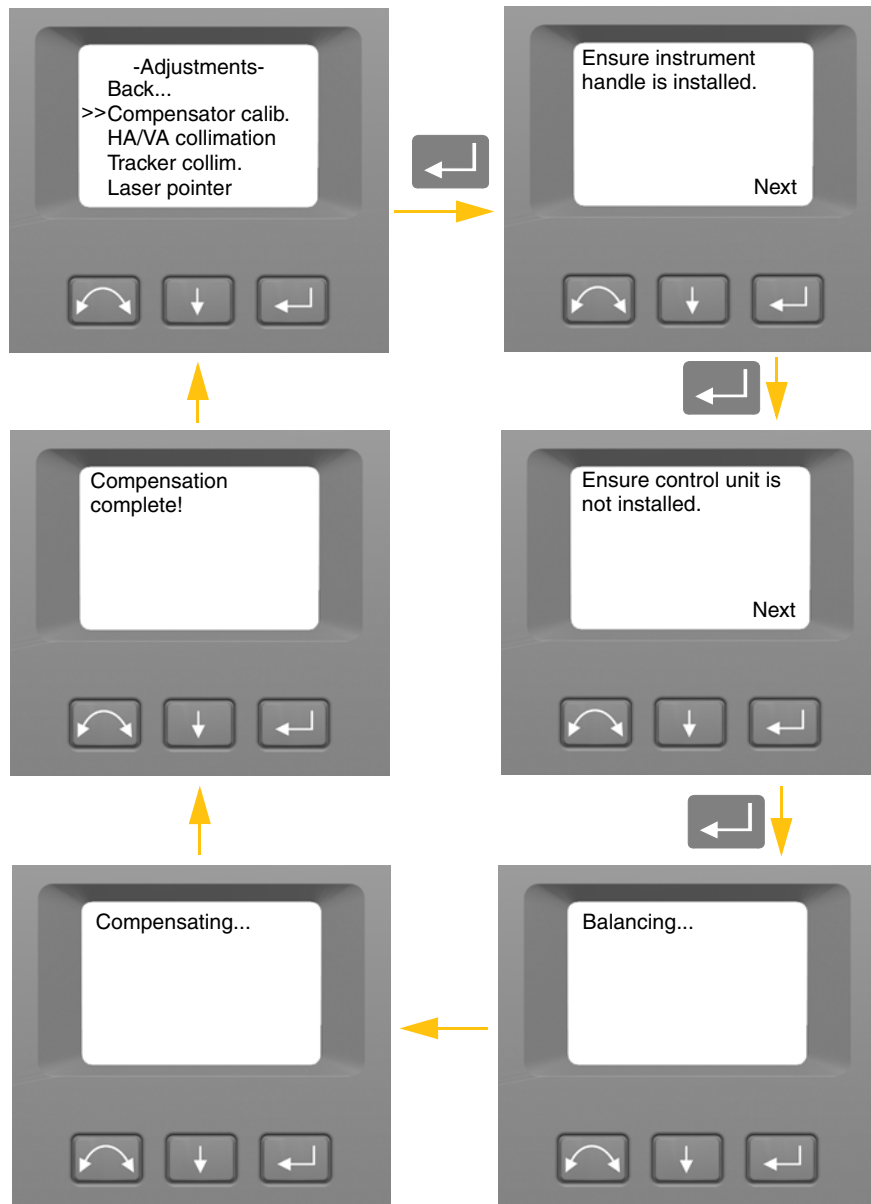

Figure 4.3 Compensator calibration routine

HA/VA Collimation and Trunnion Axis Tilt

The instrument utilizes precise angle and distance measurements to determine the position of the point being measured. The instrument's design facilitates the ability to measure all points with a single pointing to the target in the face 1 position. All electronic total stations are subject to collimation errors in both the horizontal and vertical angle measuring systems, and also errors caused by the axis of the telescope not being truly perpendicular to the vertical of the instrument.

In order to compensate for these errors, the collimation routine allows the operator to accurately determine the current errors in the instrument, and store the errors as corrections to be applied to all measurements made in a single pointing to a target. In this way the instrument will always provide accurate measurements:

The Collimation errors and Trunnion axis tilt will change over time, the most common changes being caused by

- Wear and tear with use
- Bumps and knocks during transit
- Large changes in operating temperature

Trimble recommends that a collimation check and tilt axis check be carried out routinely as follows:

- After any long uncontrolled transport of the instrument (e.g. after service or shipment to a new location)
- After any accidental knock or drop
- At any time when the operating temperature changes by more than 10°C (18°F)
- At any time when the instrument changes it's height above sea level by more than 500m (1640 Feet)
- At any time when the highest accuracy positions are required
- Routinely on a periodic basis (Monthly, weekly etc.)

Trimble also recommends that the operator keep a record of the dates and values measured so that any gross changes can easily be detected. Gross changes can indicate the need for a check by an approved service center.

The adjustment of the instrument for HA/VA collimation and Trunnion Axis tilt is a two stage process.

The Horizontal and Vertical collimation and the trunnion axis tilt correction have been measured and stored in the instrument at the factory.



In all calibrations, multiple sightings will be made in both faces to ensure that any minor pointing errors can be eliminated in the accurate determination of current collimation error values.

In a new instrument the values should be close to zero, over time these will change. The instrument allows a maximum value of 0.05 grads (0.045 degrees) in the HA, VA and Trunnion axis tilt values. If these values are exceeded, the instrument will need service to rectify a mechanical problem.

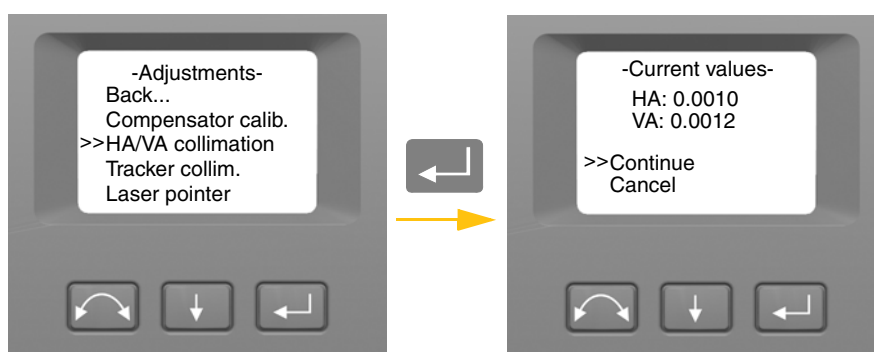
1. Press  to scroll to HA/VA collimation and then press .





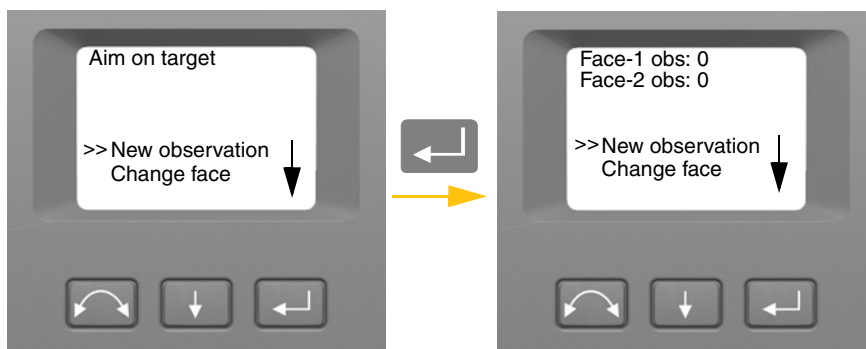

The current collimation values appear.

2. Press  to scroll to one of the following:
 - Continue Then press  to continue the HA/VA collimation test.







- Cancel. Then press  to return to the Adjustments menu.







If you select Continue:

3. Press  to scroll to one of the following:
 - New observation. Then press  to continue the HA/VA collimation test.
 - Change face. Then press  to change between face 1 and 2.
 - Cancel. Then press  to return to the Adjustments menu.

If you select New observation:

- a. Aim accurately in face 2 towards a point near the horizon at max. ± 5 grads (± 4.5 degrees) to the horizontal and at a minimum distance of 100 m (328 ft.).
- b. Press  to scroll to New observation. Then Press  to measure and record angles
- c. Re sight the instrument at the same point and press the enter key again. Repeat this process for a minimum of 5 sightings in face 2.
- d. Press  to scroll to Change face. Then press  to change to face 1.
- e. Aim accurately towards the same point as that used in face 2.
- f. Press  to scroll to New observation. Then Press  to measure and record angles
- g. Re sight the instrument at the same point and press the enter key again. Repeat this process for the same number of times as in face 2.

As observations are made on the first face (either face 1 or face 2), the angle values are stored and the counter increases. When one or more observations have been taken on each face, and the number of observations on each face are the same, the software calculates and displays the new horizontal and vertical collimation values.

4. Press  to scroll to one of the following:
 - Trunnion coll. Then press  to continue to Trunnion collimation.
 - Store correction. Then press  to accept and store the new collimation values.
 - Cancel. Then press  to return to the adjustments menu.

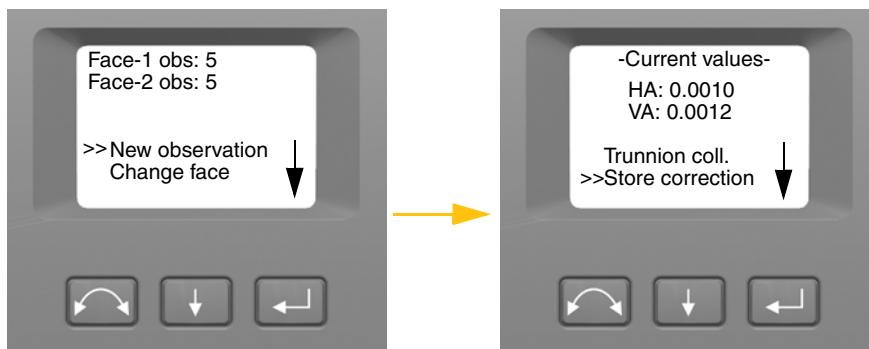



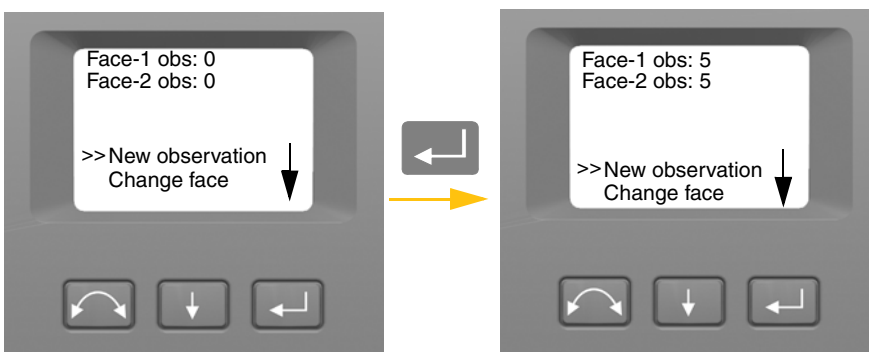
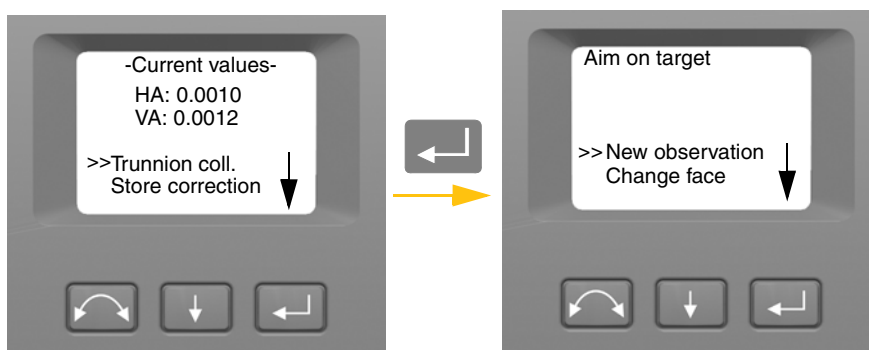

Select Trunnion coll. to continue with trunnion axis tilt collimation.

5. Press to scroll to Trunnion coll. Then press to continue the Trunnion axis tilt test.







6. Press to scroll to one of the following:
- New observation. Then press to continue the trunnion axis tilt test.
 - Change face. Then press to change face.
 - Cancel. Then press to return to the adjustments menu.

If you select New observation the number of observations in both faces appears:

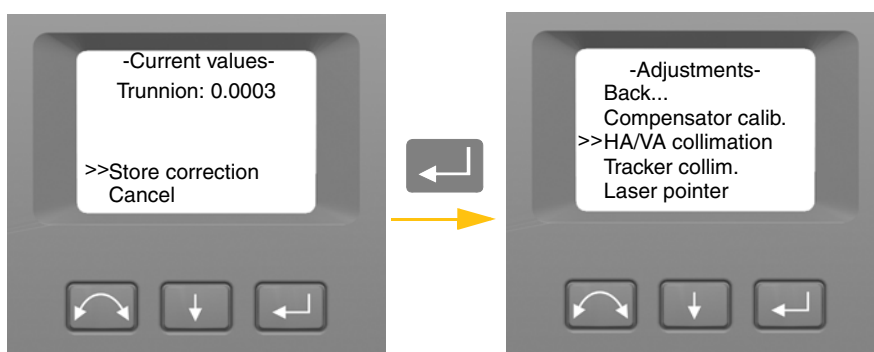
- a. Aim accurately in face 2 towards a point at least 15 grads (13.5 degrees) above or below the point where the collimation test was made at a minimum distance of 30 m (66 ft.).
- b. Press  to measure and record angles.
- c. Press  to scroll to Change face. Then press  to change face.
- d. Aim accurately towards the point.
- e. Press  to measure and record angles.

As observations are made on the first face (either face 1 or face 2), the angle values are stored and the observation counter increases. When one or more observations has been taken on each face, and the number of observations on each face are the same, the software calculates and displays the new trunnion axis tilt value.



7. Press  to scroll to one of the following:
 - Store correction. Then press  to accept the new trunnion axis tilt value. The Adjustments menu appears.
 - Cancel. Then press  to return to the Adjustments menu.

Note – The instrument will prohibit a trunnion axis tilt test if it is made towards a point with an angle less than 15 grads (13.5 degrees) from the point where the collimation test was made. The trunnion axis tilt determination accuracy will improve with a steeper angle towards the measured point. The minimum distance for the trunnion axis tilt measurement is 30 m (66 ft.).

Note – If the trunnion axis tilt correction value is greater than 0.05 grads (0.045 degrees), the message Fail Remeasure? appears. Press Yes and then repeat the measurement procedure. If the value is greater than 0.05 grads (0.045 degrees) and you answer No to the re measurement message, the instrument uses the correction value previously stored in the instrument. If the value is greater than 0.05 grads (0.045 degrees), then the instrument must be mechanically adjusted at the nearest authorized Trimble service center.

Autolock Collimation



The instrument tracker unit is designed to be coaxial with the instrument cross hairs. If for any reason the alignment of the tracker deviates from the line of the telescope cross hairs, then errors in position of the point being measured would result. For this reason an Autolock collimation check needs to be carried out on a regular basis (under the same conditions as the HA/VA collimation check) to ensure that any slight misalignment is corrected for.

Perform the test over a similar distance as that you will be working on, but at least 100 m. The prism target must be very still during the test (Trimble recommends that you use a tripod or bi-pod mount for the target) and must be in clear line of sight without any obstructing traffic. The instrument is calibrated to accurately point at the center of the target in both horizontal and vertical axes. The calibration is used to correct the positions of all points measured using the Autolock function. The measured calibration values are stored and used until a new set of calibration values are determined.

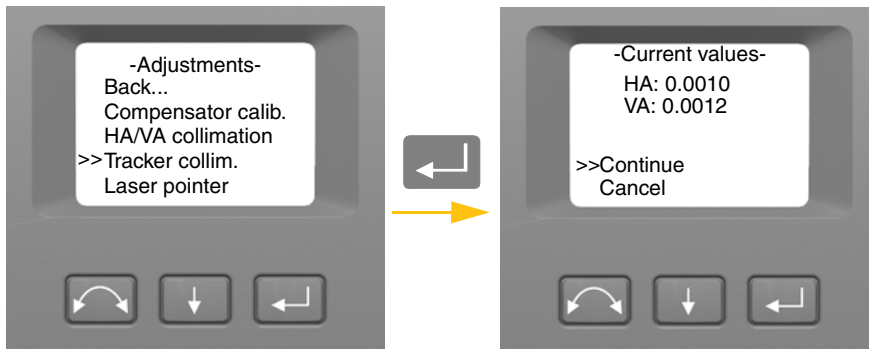

Note – The adjustment between the two optical axes, i.e. the Telescope and the Tracker, may differ.
See Aiming on page 78

1. Press  to scroll to Tracker collim then press .

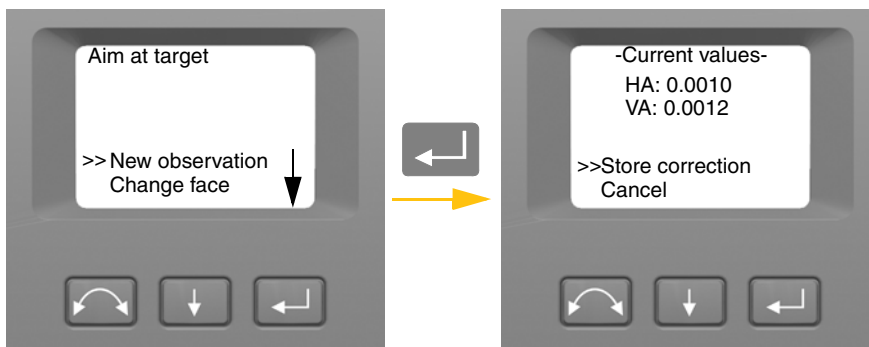

2. Accurately aim towards a prism.
3. Press  to scroll to New observation and then press .



4. The instrument will measure to the target in both faces automatically and then display the current values.
5. Press  to scroll to one of the following:
 - Store correction. Then press  to save the correction values.
 - Cancel. Then press  to return to the Adjustments menu
6. Once the instrument has stored the correction values, the Adjustments menu appears.

Laser Pointer

The laser pointer is a visible laser that is emitted from the telescope along the line of sight. The laser is used to visibly indicate the point being measured, and is especially useful when employing the DR reflectorless EDM for measurement. The laser pointer is clearly visible in areas of shadow, inside buildings and tunnels and also at night, however in bright sunshine it is generally not readily visible with the human eye.

The following controls allow the laser pointer to be switched On and Off.

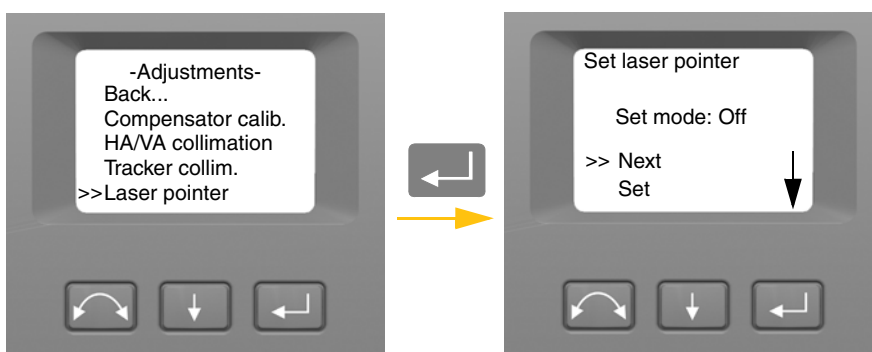

Note – The laser pointer is mechanically aligned to the telescope cross hairs. The laser may require periodic adjustment to keep it perfectly aligned for measurement. In order to adjust the laser pointer it has to be switched On, see page 4-54

1. Press  to scroll to Laser pointer then press .

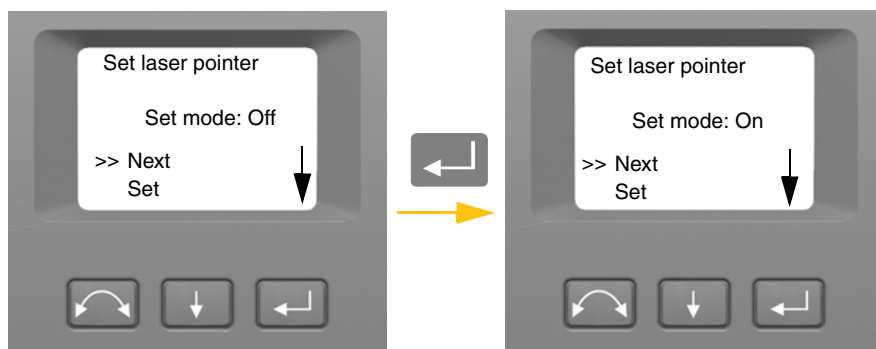

2. To change the laser pointer setting press  to select Next and then press  to select On or Off



3. When you have found the setting of your choice press  to select Set and then press  to store this setting. You will then be returned to the Adjustments menu.

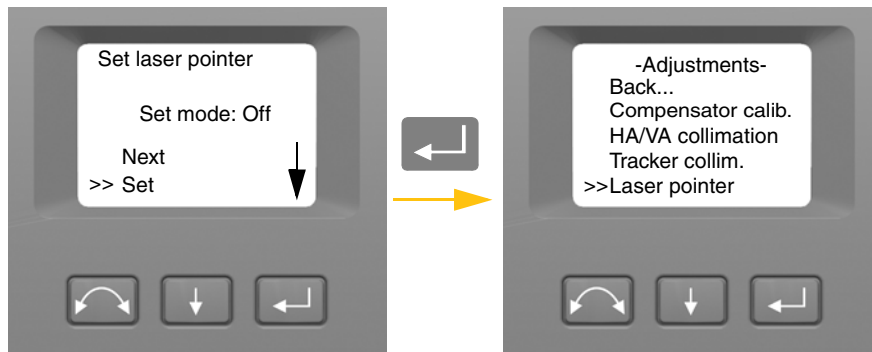

4. If you want to cancel Press to select Cancel and then press to return to the Adjustments menu.

With the laser pointer on, you can adjust the beam, For more information, see [The Laser Pointer](#), page 54.

Autofocus calibration

The instrument is equipped with an autofocus function. Before you can start using the autofocus, the function needs to be calibrated.

To start the calibration

1. Remove the CU from the instrument
2. Level the instrument. The instrument will automatically check if the compensator is within range before the calibration is started.
3. Press to scroll to Autofocus calib and press

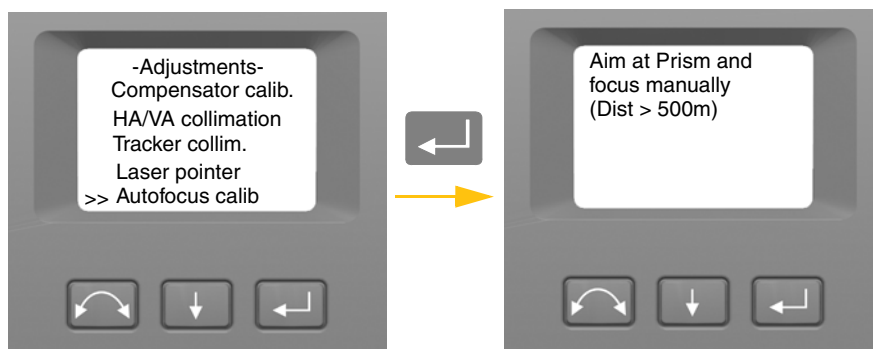

4. Aim and manually focus at a target at a distance of at least 500 meters Then press .

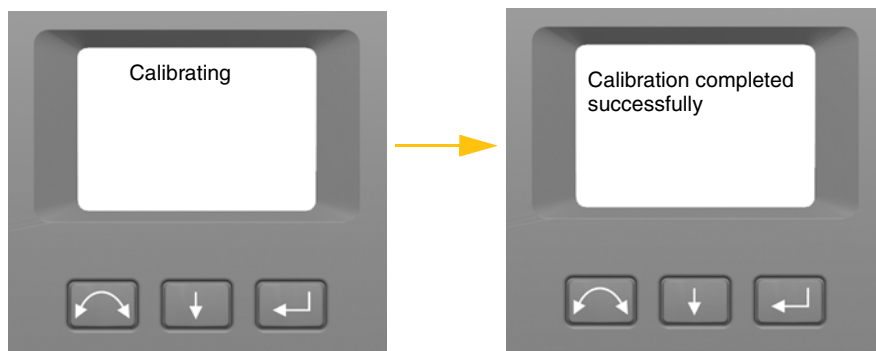

Back

1. To return to the Setup menu, press to scroll to Back... and then press .

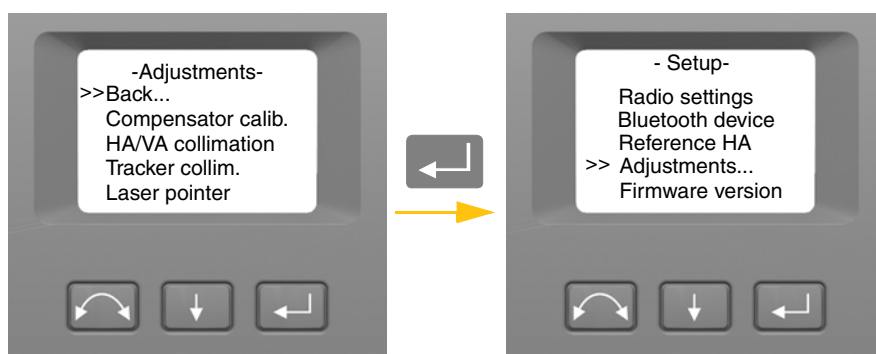

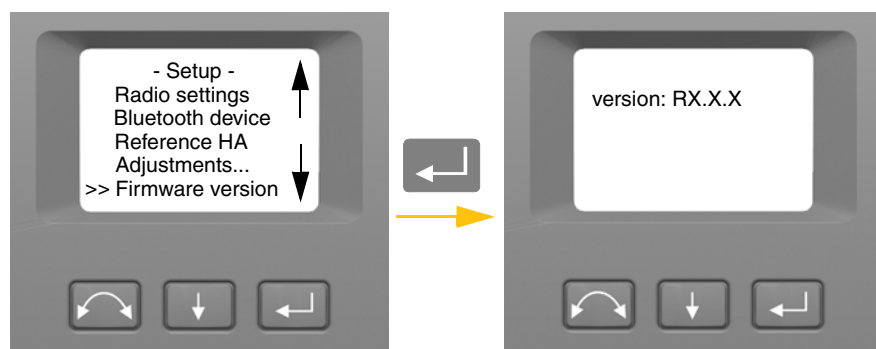

Firmware Version Information

1. Press to scroll to Firmware version and then press . The instrument firmware version appears on the screen. The program will return automatically to the Setup menu.



Service Info



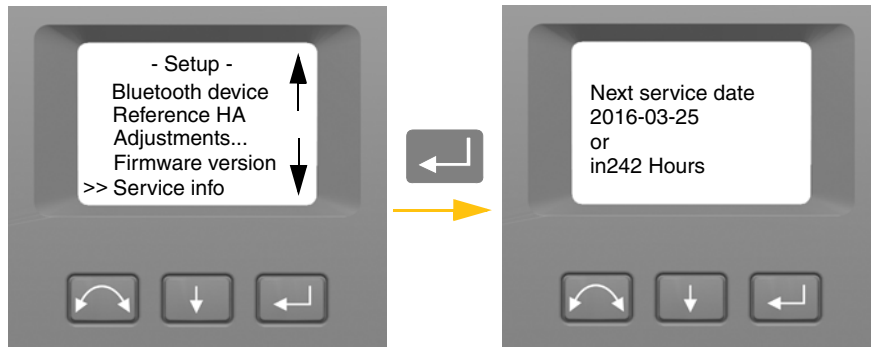

In the Service info menu it is possible to see the date for the next recommended service occasion or how many run time hours the instrument have left before service is recommended.

1. Press  to scroll to Service info and then press . The instrument service info appears on the screen. The program will return automatically to the Setup menu.





Select Language

In the Select language it is possible to select the language for the Face 2 display.

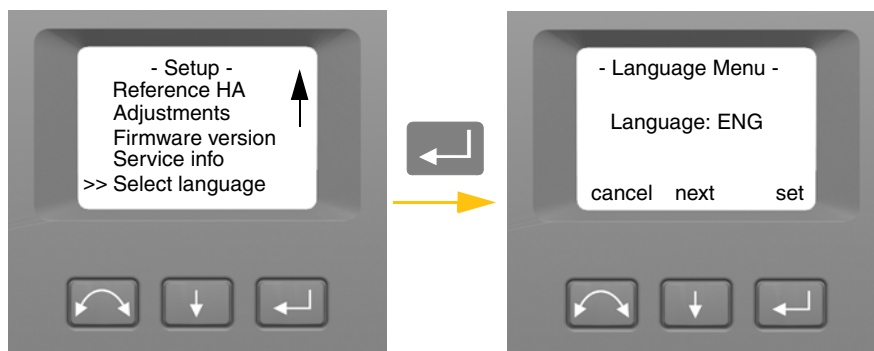
1. Press  to scroll to Select language and then press .
2. Press  to scroll through the available languages.
3. Press  to set language.



Exit Menu

1. To exit the Setup menu press  to scroll to Exit (to level) and then press . The electronic level appears.

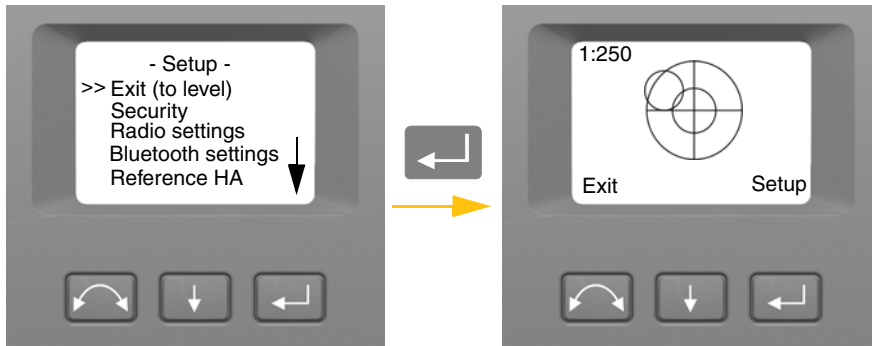

Note – If the instrument is left idle for more than 300 seconds (5 minutes) during any of the above routines, then the instrument goes to suspend mode.

The Laser Pointer

The Trimble S7 Total Station uses a red laser only as a laser pointer. The laser pointer is coaxial with the line of sight of the telescope. If the instrument is well adjusted, the red laser pointer coincides with the line of sight. External influences such as shock or large temperature fluctuations can displace the red laser pointer relative to the line of sight.

Aligning the Laser Pointer



CAUTION – Viewing the laser spot on the adjustment target through the telescope is safe. Do not try to make the adjustment using a prism, the reflected light from a prism can be dazzling.



CAUTION – Do not use the laser pointer as an aid when searching for prisms, the reflected light can dazzle your eyes. The reflected light will not damage your eyes, but might be uncomfortable.

To avoid faulty measurements when using the laser pointer for aiming, use the supplied adjustment target to check the laser alignment regularly and before you attempt precise distance measurements:

1. Setup the adjustment target 25–50 meter away, facing the instrument.
2. Aim the instrument to the center of the target plate and then inspect the position of the red laser spot in relation to the telescope cross-hairs.
3. If the red laser spot lies outside the cross-hairs, adjust the direction of the beam until it matches the cross-hairs, see Figure 4.4

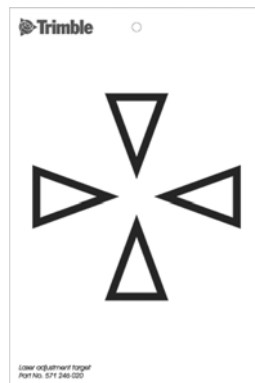

Figure 4.4 Adjustment target for Trimble S7 Total Station

Adjusting the Laser Pointer

1. Pull out the two plugs from the adjustment screw access holes on top of the telescope housing.
Figure 4.5



Figure 4.5 Access holes for the Laser pointer adjustment screws

2. To correct the vertical position of the laser spot, insert the Allen key into the access hole for the vertical adjustment screw and turn it as shown in figure 4.6.

Clockwise = Down
Counter clockwise = Up



Figure 4.6 Laser pointer vertical position adjustment

3. To correct the horizontal position of the laser spot, insert the Allen key into the horizontal adjustment port and turn it as shown in Figure 4.7.

Clockwise = Left
Counter Clockwise = Right

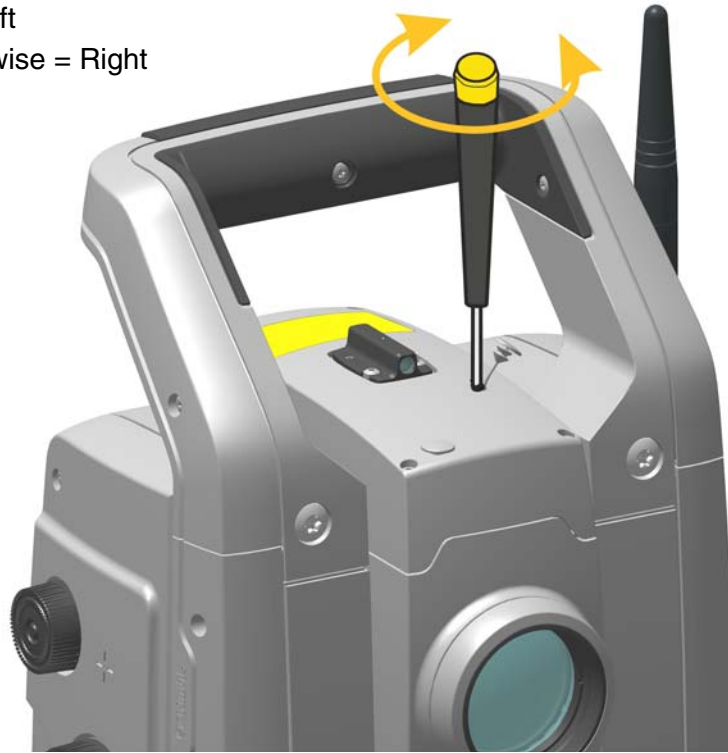

Figure 4.7 Laser pointer Horizontal position adjustment

4. Check the alignment of the laser spot and the cross-hairs. Throughout the adjustment procedure, keep the telescope pointing to the adjustment target. The adjusting screws are of a high tension because they are self locking. The screws tighten automatically after you adjust them.
5. Refit the plugs in the adjustment holes. Make sure that the plugs are correctly fitted for proper sealing against the cover.



CAUTION – To keep out moisture and dust, make sure that the plugs are correctly fitted in the adjustment ports.

Measuring the Instrument Height

There are two measurement marks on the side of the instrument. The top mark corresponds to the trunnion axis of the instrument. The bottom mark is 0.158 m (0.518 ft.) below the top mark. Measure the bottom mark to the top ridge of the mark. *Figure 4.8*

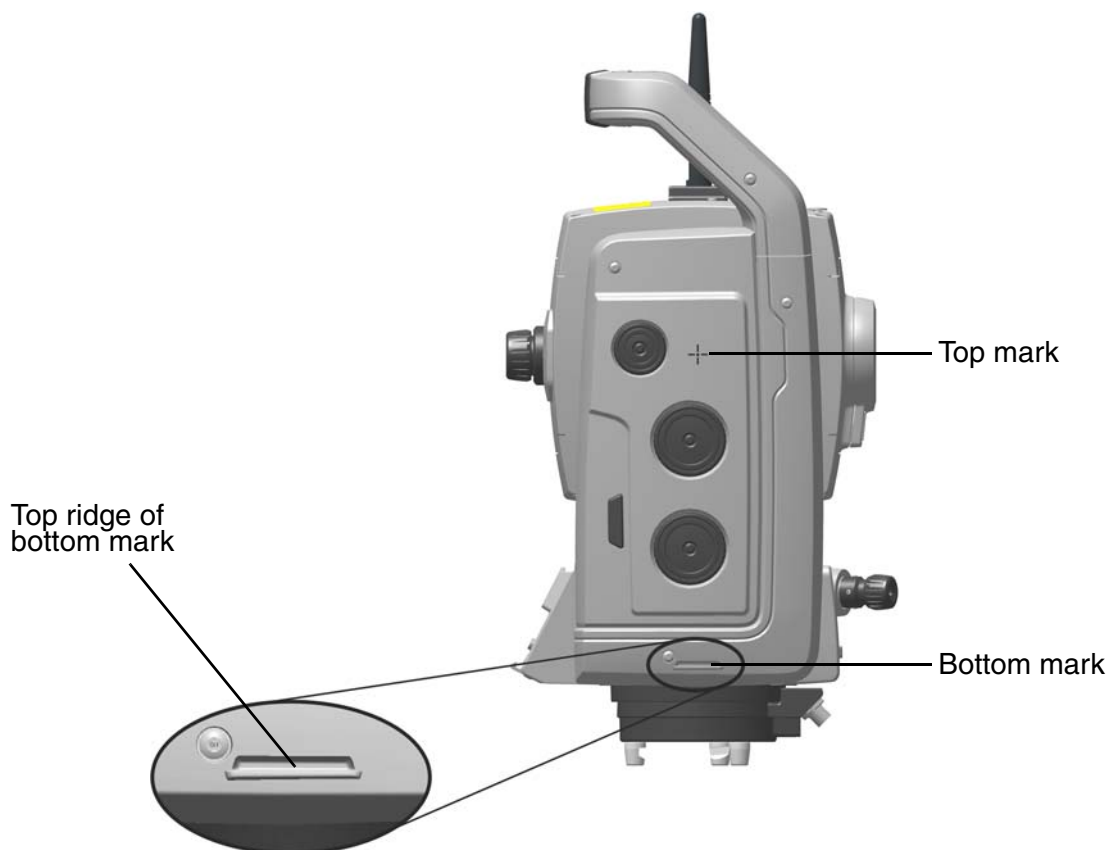

Figure 4.8 Instrument height marks

When there is a Trimble CU or TSC3 attached running a field application software, the software has additional functions that reduce the bottom mark measurement to the required vertical instrument height to the trunnion axis, see *Figure 4.9* and the following paragraph.

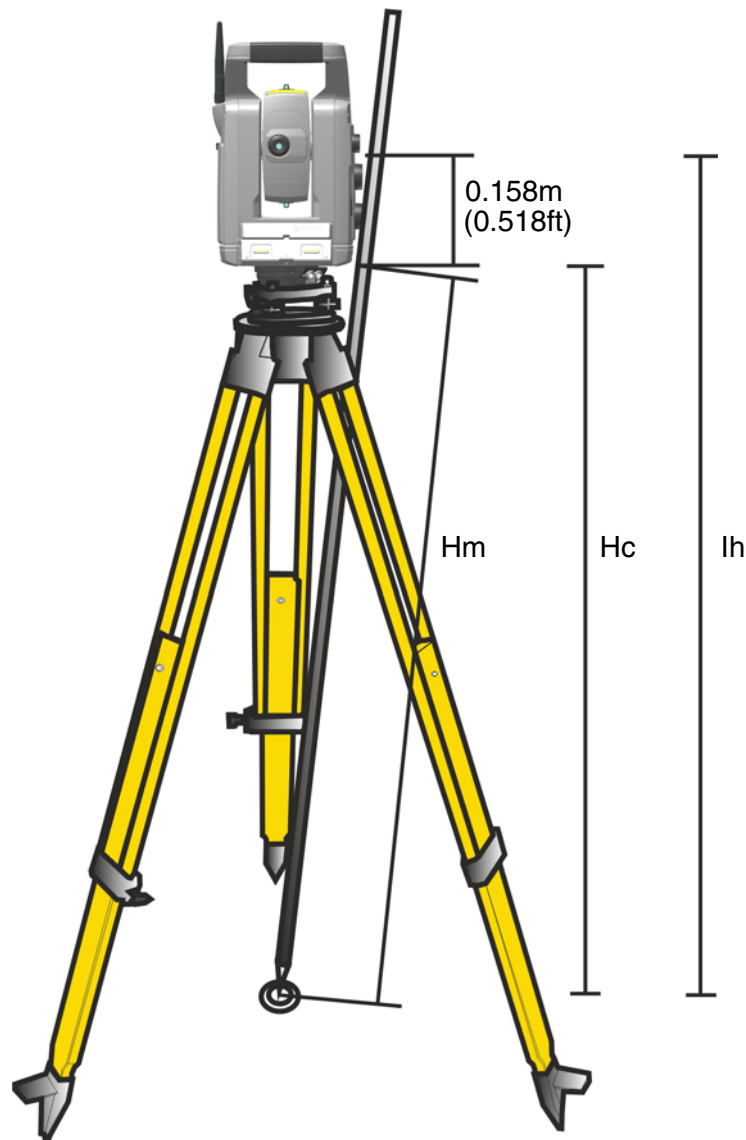

Figure 4.9 Instrument height measurement

The measured distance (H_m) is corrected for the slope of the measurement to obtain a vertical measurement to the bottom mark (H_c). The constant from the bottom mark to the top mark (0.158 m/0.518 ft.) is added to the H_c to obtain the vertical instrument height from the ground mark to the trunnion axis (I_h). For more information, refer to the field software documentation.

Alternatively, to obtain an accurate measurement to the top mark (I_h), you can manually measure the slope distance from the ground to the bottom mark (H_m). To calculate the total instrument height (I_h), insert the measured slope distance (H_m) into the formula below:

$$I_h = 0,158 + \sqrt{H_m^2 - 0,091^2}$$

Adjusting the Optical Plummet

1. Set up the instrument and level it over a ground mark so that the tripod height is 1.5 m (± 0.1 m) (4.920 ft. (± 0.328 ft.)). *Figure 4.10*
2. Note the position of the inner circle of the optical plummet in relation to the ground mark.
3. Turn the instrument 200 grads (180 degrees).
4. Note the position of the inner circle of the optical plummet in relation to the ground mark. If the inner circle of the optical plummet reticule moves in relation to the ground mark, you must adjust the plummet reticule location.
5. Adjust out half of the error with the four adjustments screws on the optical plummet.
6. Turn the instrument 200 grads (180 degrees).
7. If there is no movement between the inner circle of the optical plummet reticule in relation to the ground mark, no further adjustment is needed.



CAUTION – When adjusting the optical plummet with the four adjustment screws it is important that the screws are correctly adjusted. When one screw is adjusted the opposite screw must be adjusted equally in the reverse direction, in order to keep the correct tension on the optics. Do not over tighten the screws, this might damage the optics.

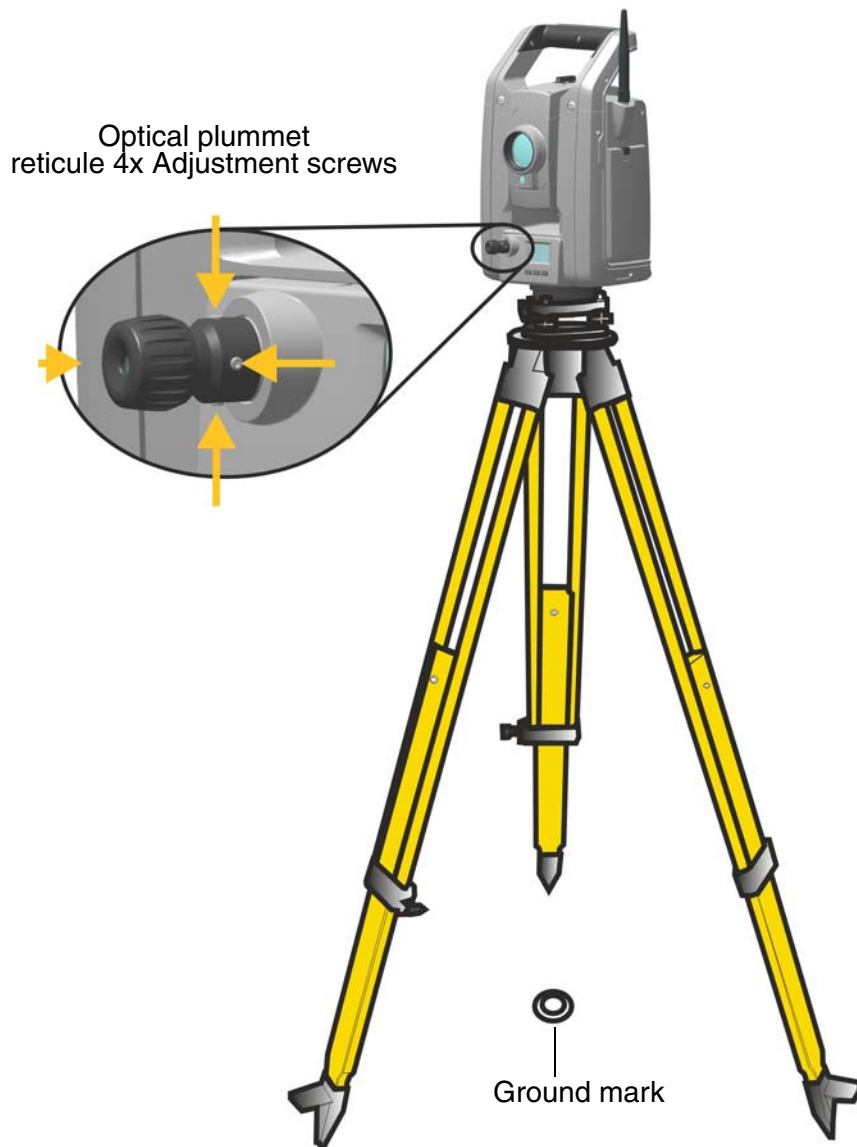

Figure 4.10 Optical plummet adjustment

Pre Measurement Check List

Before you begin measurement or stake out operations, check the following items:

- Lenses are clean
- Instrument is correctly leveled
- Collimation error
- Tracker collimation error (if the instrument is equipped with Autolock capability)
- Trunnion axis tilt
- Correct radio channel is selected (robotic measurements only)

- Laser Pointer beam alignment
- Measure instrument height
- Allow sufficient time for the instrument to adjust to the ambient temperature, see page 29

Connecting a Controller

To perform surveying with the instrument a controller must be connected to the instrument running a field software.

Trimble CU Controller

The Trimble CU controller (TCU) can be used as a controller for the instrument.

The TCU can use different methods to communicate with the instrument:

- Attached to the attachment on the instrument (A).
- Bluetooth® wireless technology, when attached to Robotic Holder or Docking Station (B).
- Radio, with robotic instruments when attached to Robotic holder (C).

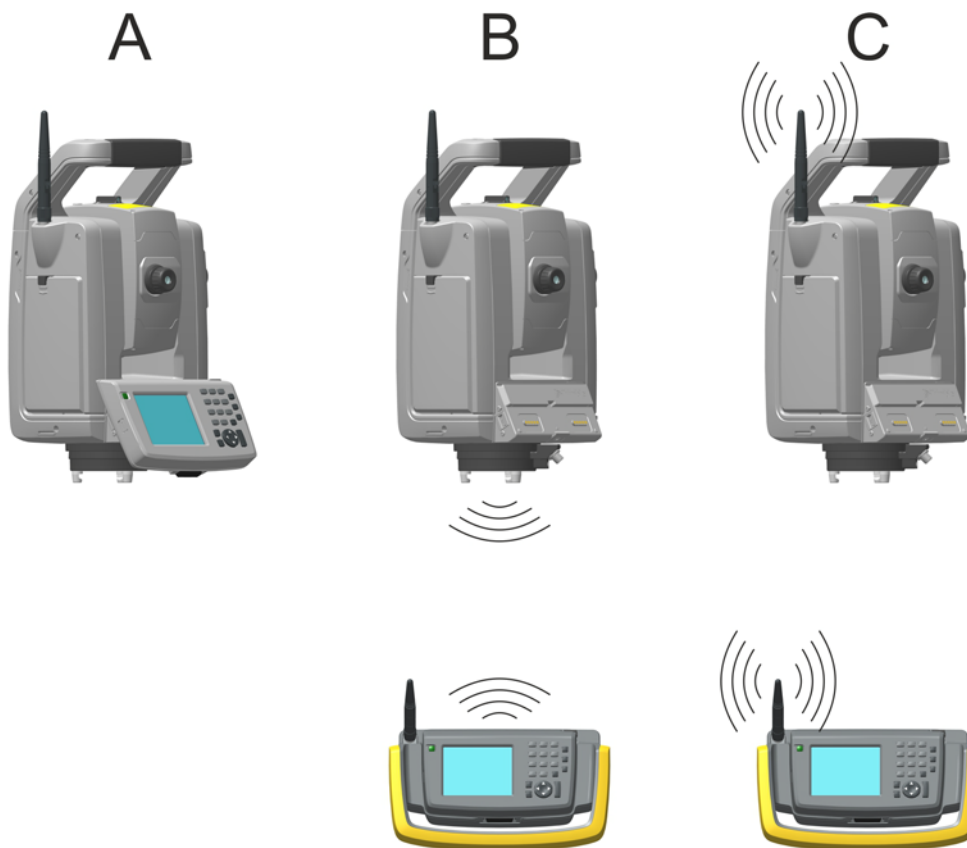

Figure 4.11 Connecting the TCU to the instrument

Attaching the TCU to the Instrument

1. Hook the top of the TCU over the top edge of the panel attachment, Figure 4.12



Figure 4.12 Attaching the TCU to the instrument

2. Push the bottom of the TCU toward the panel attachment until it clicks into place, Figure 4.13



Figure 4.13 Attaching the TCU

Detaching the TCU



CAUTION – When the TCU is removed from the instrument it is recommended to have the TCU in suspend or off mode.

To remove the Trimble CU from the instrument when in on mode will not damage the equipment, but files that are being saved or written to when the TCU is being removed might be damaged or lost.

1. Push the lock release button on the bottom of the TCU, Figure 4.14 (1)
2. Lift the bottom of the TCU away from the instrument, Figure 4.14 (2)

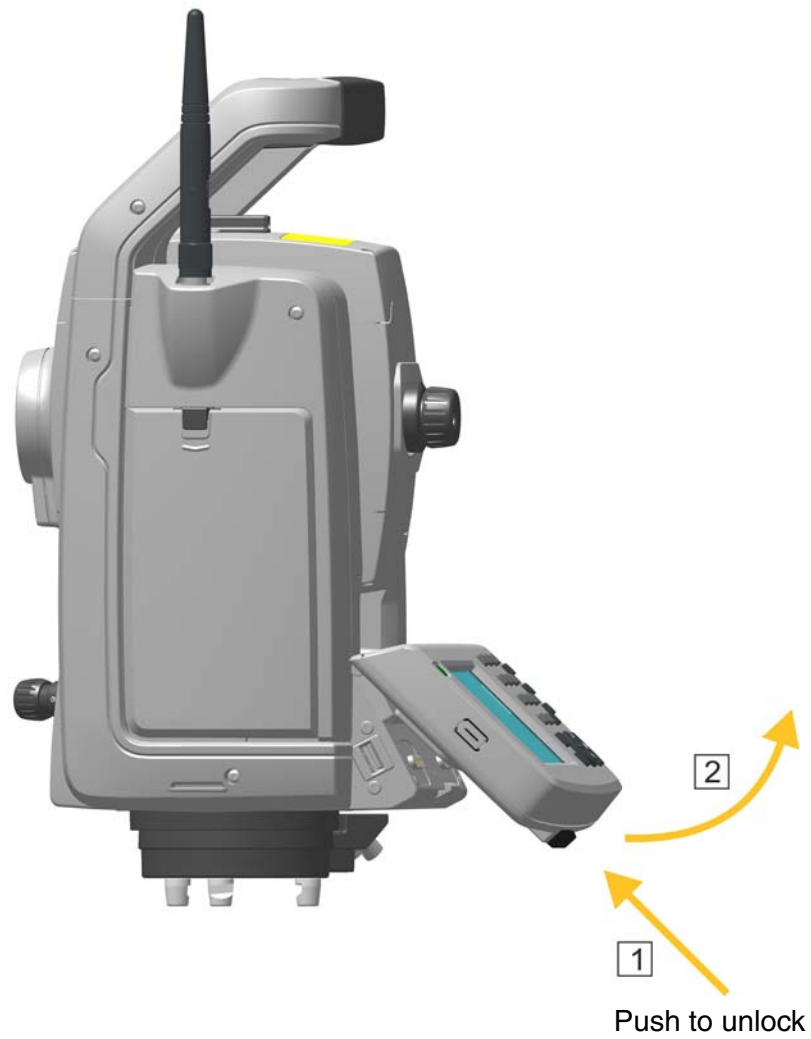

Figure 4.14 Detaching the TCU

3. Unhook the top of the TCU from the top edge of the panel attachment and remove the TCU from the instrument, Figure 4.15



Figure 4.15 Detaching the TCU

Note – When a Trimble CU Controller is not attached to the instrument the Panel Attachment Cover P/N 50014012 should be attached for full ESD protection and to protect the connectors from mechanical damage and corrosion. See ESD Information on page VI

Connecting With Bluetooth® Wireless Technology



CAUTION – Before activating the Bluetooth device, make sure that the local regulations allows the use of Bluetooth wireless technology.

The TCU has integrated Bluetooth wireless technology. Refer to the field software documentation regarding how to activate and set up the TCU Bluetooth device.

The TCU must be attached to a Robotic Holder for power supply. To set up the Robotic Holder, See Trimble Robotic Holder on page 101

Connecting with Radio

A robotic instrument is equipped with a radio that can communicate with the TCU through the radio in a Robotic Holder. The TCU must be attached to a Robotic holder for power supply and connection to a radio.

The two radios must be set to the same channel to be able to establish communication. The radio channel for the instrument radio can be set in the following ways:

- In the face 2 panel, *see page 4-37*
- In the TCU field software when the TCU is attached to the instrument attachment, *see page 4-63*

Trimble TSC3 Controller

The Trimble TSC3 controller (TSC3) can be used as a controller for the instrument.

The TSC3 can use different methods to communicate with the instrument:

- Cable connected to the instrument (A).
- Bluetooth® wireless technology (B).
- Radio, with robotic instruments (C).

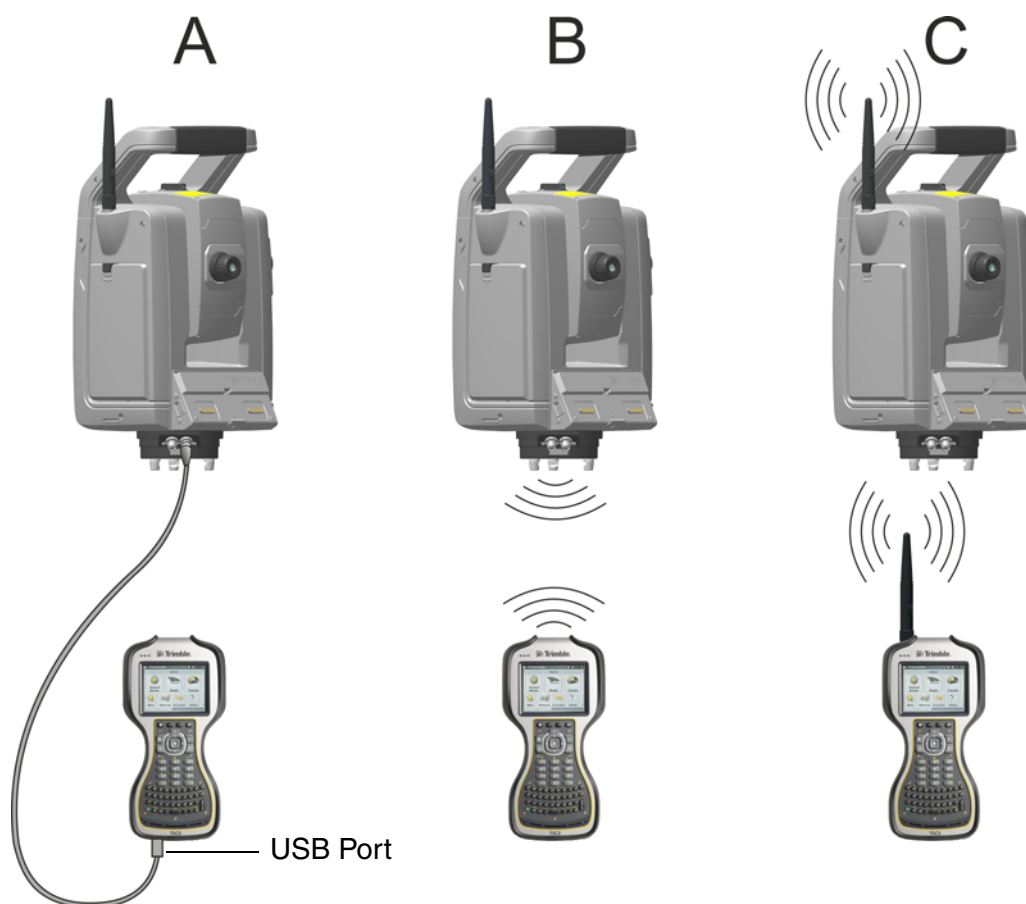

Figure 4.16 Connecting the TSC3 to the instrument

Connecting With Cable

The TSC3 is connected from the instrument com port to the USB connector on the TSC3 using cable part number 73840001.

Connecting With Bluetooth® Wireless Technology



CAUTION – Before starting the Bluetooth device, make sure that the local regulations allows the use of Bluetooth wireless technology.

The TSC3 has integrated Bluetooth wireless technology. Refer to the field software documentation regarding how to activate and set up the TSC3 Bluetooth device.

Connecting with Radio

A robotic instrument is equipped with a radio that can communicate with the TSC3 through the integrated radio.

The radios must be set to the same channel to be able to establish communication. The radio channel for the instrument radio can be set in the following ways:

- In the face 2 panel, *see page 4-37*
- In the TSC3 field software when the TSC3 is connected to the instrument with a cable, *see Figure 4.16*

Instrument Technology

In this chapter:

- Angle Measuring Technology
- Distance Measuring Technology
- Autolock Technology
- Tracklight
- Trimble VISION™ Technology
- SureScan Technology
- Locate2Protect Technology
- Servo Technology
- Power Management
- External Communication

Angle Measuring Technology

The principles of angle measurement are based on reading an integrated signal over two opposite areas of the angle sensor and producing a mean angular value. This eliminates inaccuracies caused by eccentricity and graduation.

In addition, the angle measurement system compensates for the following automatic corrections:

- Instrument mislevelment (deviation of the plumb axis).
- Horizontal and vertical collimation error.
- Trunnion axis tilt. See [page 71](#)

Correction for Mislevelment

The instrument automatically corrects for mislevelments up to $\pm 6'$. The instrument warns the operator immediately of any mislevelments in excess of $\pm 6'$ (± 0.11 grads).

The instrument also utilizes SurePoint™ accuracy assurance technology to automatically correct the pointing of the telescope for all mislevelment and trunnion axis errors in real time during operation.

Corrections for the horizontal angle, vertical angle, and slope distance are calculated in the field application software and applied to all measurements.

Correction for Collimation Errors

The horizontal collimation error is the deviation of the sighting axis from its required position at right angles to trunnion axis.

The vertical collimation error is the difference between the vertical circle zero and the plumb axis of the instrument.

Traditionally, collimation errors were eliminated by observing angles in both instrument faces. In the Trimble S7 Total Station, a pre-measurement collimation test is performed to determine the collimation errors. Angular measurements are observed in both instrument faces, the collimation errors are calculated, and the respective correction values are stored in the instrument. The collimation correction values are then applied to all subsequent angle measurements. Angles observed in a single face are corrected for collimation errors, which eliminates the need to measure in both instrument faces.

Carry out a collimation test in the following situations:

- Whenever the instrument may have been roughly handled during transport.
- When the ambient temperature differs by more than 10°C (18°F) from the previous collimation test.
- Immediately prior to high precision angle measurements in one face.

Trimble S7 Total Station With Autolock technology

A Trimble S7 Total Station contains with Autolock technology that can automatically lock on to and track a prism and or active target. Pointing errors caused by slight misalignment of the instruments tracker have a similar effect to the HA and VA Collimation errors detailed above.

To correct for the tracker collimation errors, carry out an Autolock collimation test. The Autolock collimation test automatically observes angular measurements to a target in both faces, the tracker collimation errors are calculated and the respective correction values are stored in the instrument. The Autolock collimation correction values are then applied to all subsequent angle measurements observed when Autolock is enabled. Angles observed in a single face are corrected for collimation errors, which removes the need to measure in both instrument faces.

Carry out an Autolock collimation test in the following situations:

- Whenever the instrument may have been roughly handled during transport.
- When the ambient temperature differs by more than 10°C (18°F) from the previous collimation test.
- Immediately prior to high precision angle measurements using Autolock in a single face.

Correction for Trunnion Axis Tilt

The trunnion axis tilt error is the deviation of the trunnion axis of the telescope from its required position at right angles to the plumb axis of the instrument. See Figure 5.1

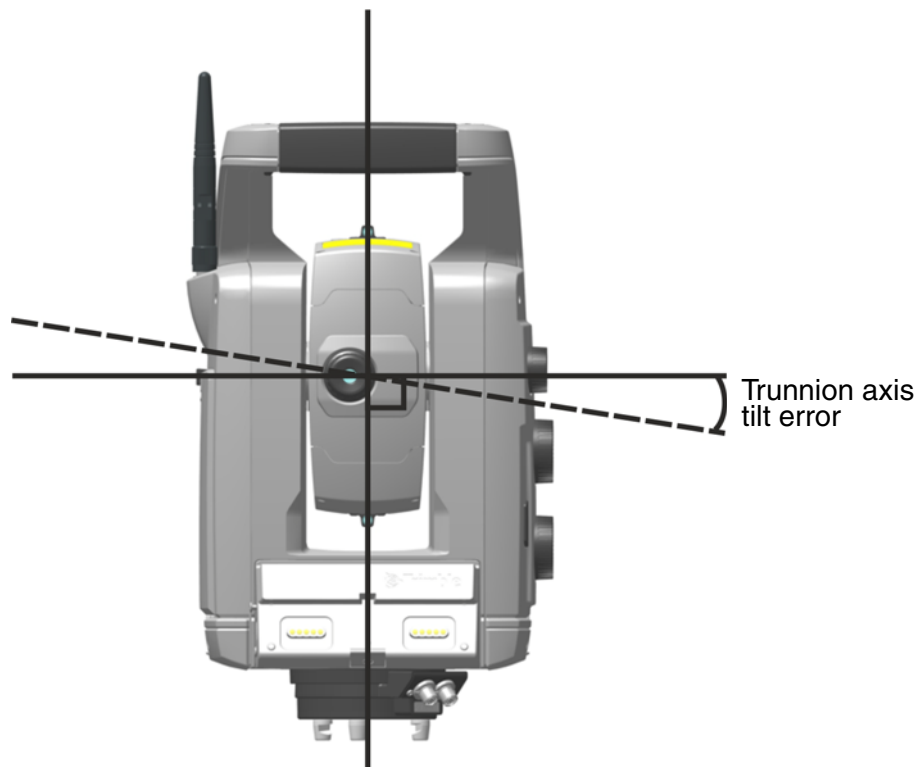

Figure 5.1 Trunnion axis tilt error

In the instrument, perform a pre-measurement trunnion axis tilt test to determine the trunnion axis tilt error. Angular measurements are observed in both instrument faces, the trunnion axis tilt error is calculated, and the respective correction value is stored in the instrument. The trunnion axis tilt correction value is then applied to a correction to the horizontal angle value and an automatic repointing of the telescope using Surepoint technology.

Carry out a trunnion axis tilt test in the following situations:

- Whenever the instrument may have been roughly handled during transport.
- When the ambient temperature differs by more than 10°C (18°F) from the previous collimation test.
- Immediately prior to high precision angle measurements in one face, especially where the vertical angles significantly deviate from the horizontal plane.

Averaging Measurements to Reduce Sighting Errors

The instrument automatically reduces sighting errors caused by the misalignment of the instrument to the target or by pole movement during measurement. The following techniques can be used:

- Use Autolock. When Autolock is enabled, the instrument automatically locks onto and tracks the target. Manual sighting errors are reduced.
- Automatically average angles during distance measurement. When measuring in Standard mode, the instrument takes approximately 1.2 seconds to measure the distance. Angles returned to the instrument at 1000 Hz, are averaged over the 1.2-second period to obtain an averaged angle measurement. The resultant angle measurement is an average of over 1200 observations.
- Use average measurement methods in the field software.

Distance Measuring Technology

The instruments are equipped with a combined distance unit. This means that the instrument can measure to a prism or to normal surfaces (direct reflex (DR) mode).

The Trimble S7 Total Station's EDM is a pulsed laser distance unit that determines distances by precisely measuring the flight time of the transmitted light pulse. The distance unit generates many short laser pulses, which are transmitted through the telescope to the target. The pulses reflect off the target surface and return to the instrument where the unit determines the time difference between the transmitted pulses and the received pulses. The unit uses the time difference to calculate the distance to the target.

The distance unit includes additional functions that allow you to control the accuracy and precision of a DR measurement through the field application software.

field application software includes:

- Standard Deviation. This allows you to configure the required precision of the DR measurement before the distance will be accepted. The distance measurement process will be carried out by the instrument until the preset standard deviation value has been achieved. The default standard deviation value is 0.003m. Setting this value to a higher number gives shorter measurement time but is less accurate, especially when measuring to surfaces at greater distances or at oblique angles to the line of sight.

- **Weak Signal.** This allows you to accept a DR measurement that is below the normal instrument specification. This is useful when measuring to poor reflective surfaces, or when trying to achieve the maximum range of the instrument.
- **Min.-Max Range.** This allows you to specify the DR measurement interval. For example, when you measure to a small object at 50 m with a background object at 200 m, set the min.-max range from 2 m to 100 m. The distance meter is then tuned to provide a distance within the specified range and to ignore any signal from outside the defined range. By default, the min.-max range is 2–300 m.

Beam Divergence

All distance meter measurement beams diverge as the range from the instrument increases. The divergence of the distance meter beam relates to an increase in the size of the area being sampled, not to a degradation of the measurement precision. See [Figure 5.2](#)

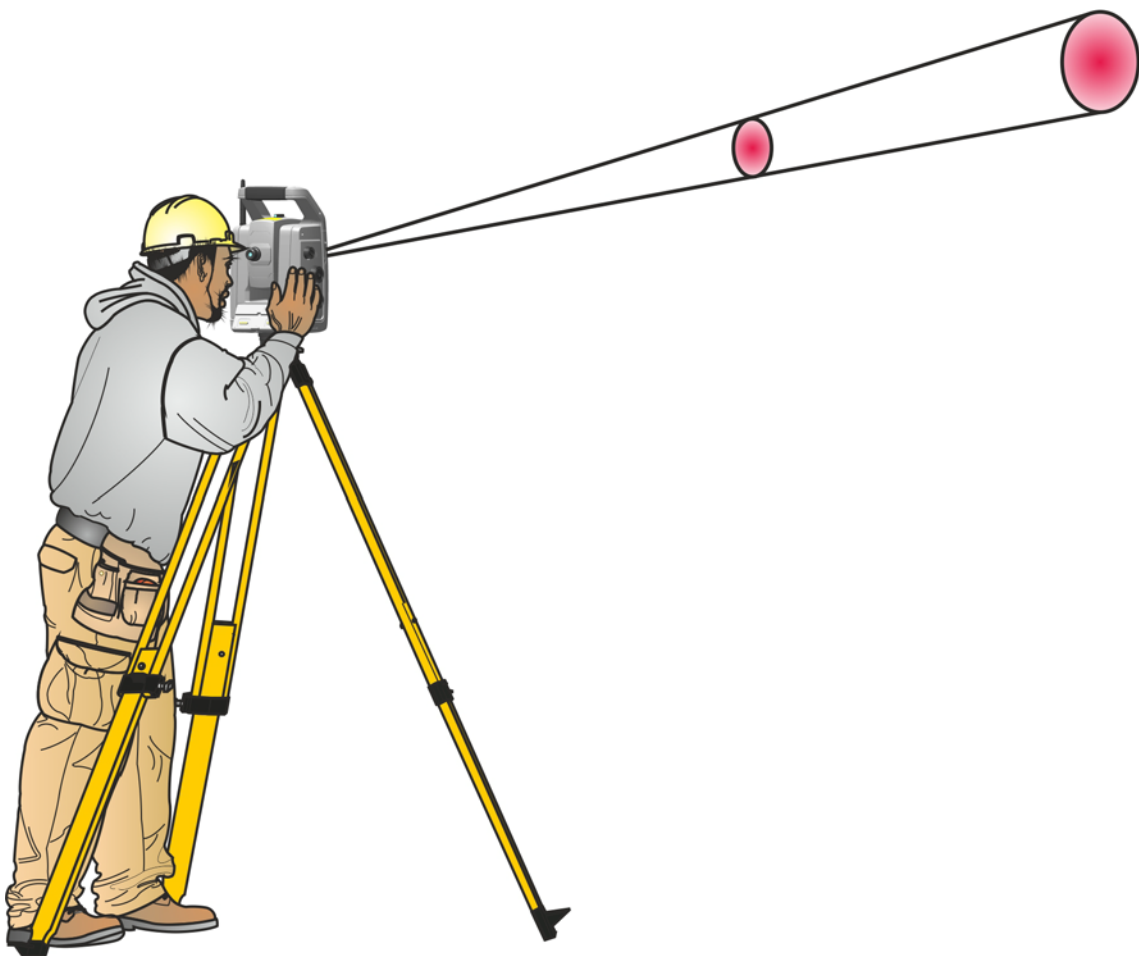

Figure 5.2 Beam divergence

A larger measuring area at longer range is generally better because it enables smaller objects, such as power lines and antennas, to be detected and accurately measured. With a smaller measuring area, these small objects can be easily missed. A smaller measuring area has advantages when

measuring tight corners and vertices at close range. When observing measurements to a tight corner, the distance meter beam divergence introduces a range error caused by the size of the sampling area. See Figure 5.3

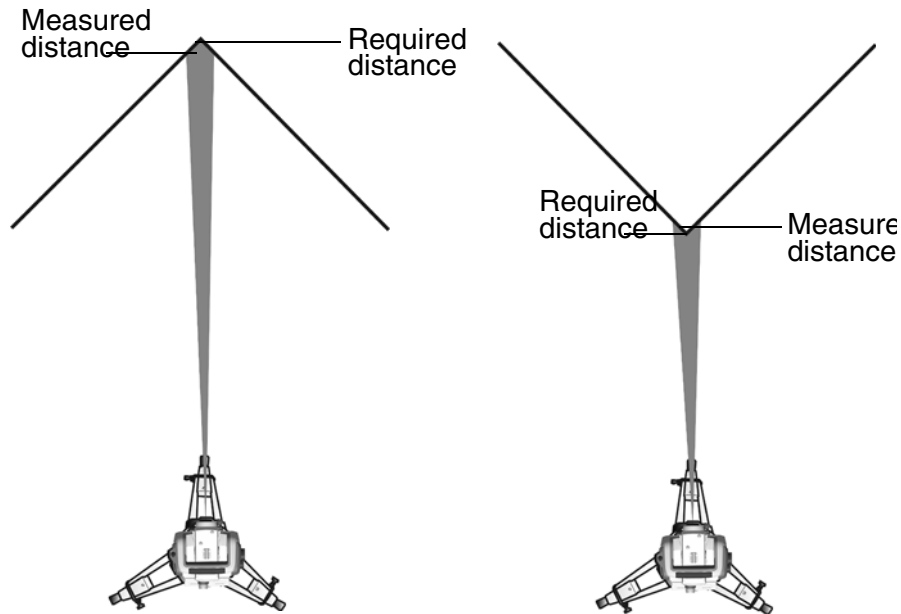

Figure 5.3 Measuring to an inner and an outer corner

Although the problem is reduced with a beam that uses a smaller measuring area, the error can not be completely eliminated. The most accurate solution to measure to tight corners and eliminates errors caused by beam divergence, is to use an offset measurement method such as that used in the field application software:

1. Measure two points on the face of the building.
2. Aim the instrument at the corner to store the correct horizontal and vertical angle. See Figure 5.4

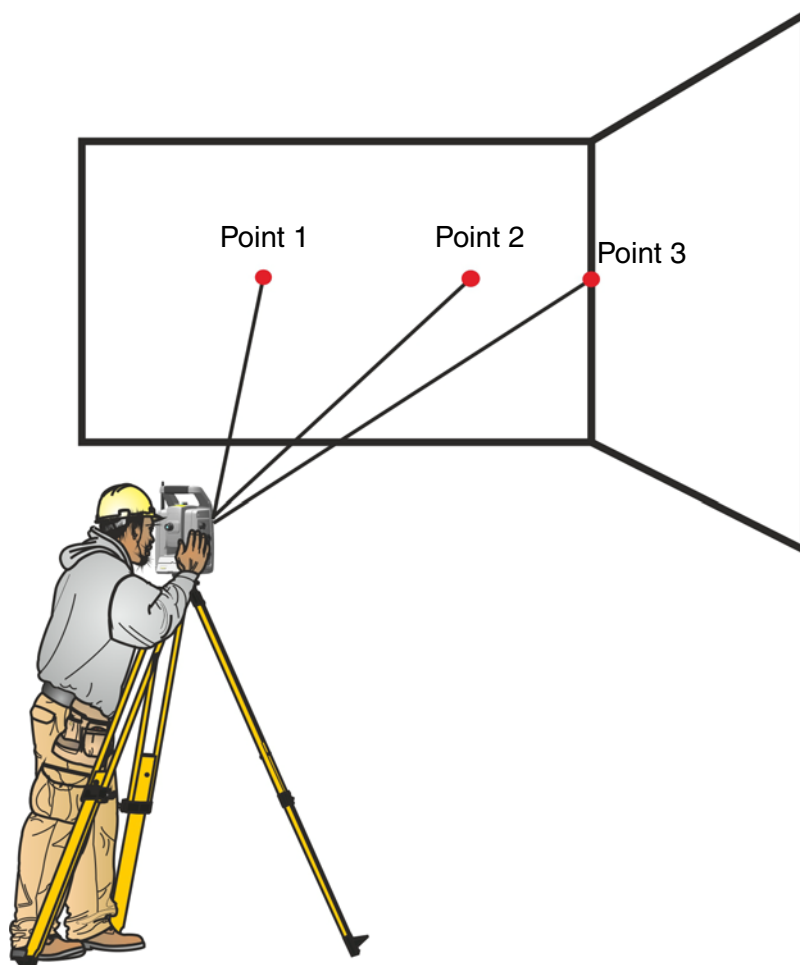



Figure 5.4 Offset measurement

With offset measurements, you can accurately measure difficult locations with DR instruments, and eliminate beam divergence errors. For more information, refer to the field application software documentation.

Autolock Technology

The instrument is equipped with Autolock technology, which is used for a robotic or a conventional measurement with Autolock.

Autolock technology controls the instrument servos and aims the instrument correctly towards the target. See Figure 5.5

 **Tip** – To assure maximum performance from the Autolock technology keep the lens clean and dry.

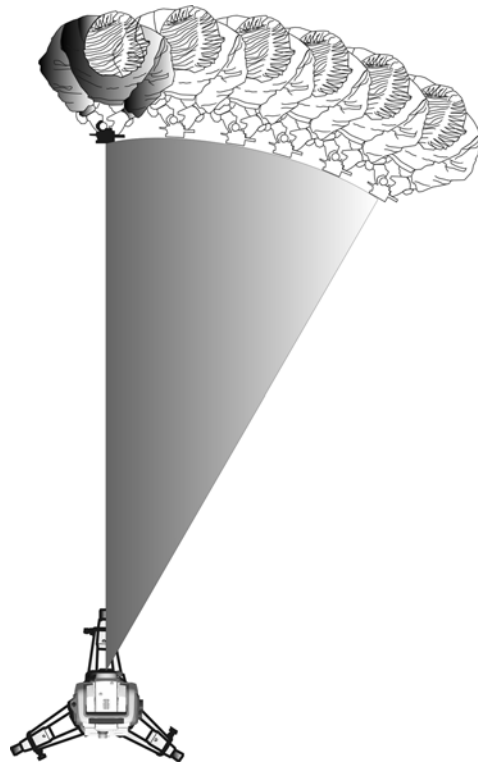

Figure 5.5 The Trimble S7 Total Station Autolock function.

The instrument can lock onto and track a target in two different modes depending on the type of target.

Passive mode:

In passive mode the instrument can lock onto and track a prism.

SplitVision:

When a Target ID is added to a prism the instrument will lock onto and track the active Target ID horizontally and the passive prism vertically.

Selection of the appropriate mode can be made via the field software interface while selecting the 360 target with Target ID prism type.

Note – Make sure to select the correct target in the field software to ensure correct lock and tracking of the target.



CAUTION – For precision measurements, when using the 360 degree prism, it is important to turn the prism, so that one of the prisms is pointed at the instrument.

FineLock™ Technology

The Trimble S7 Total Station is equipped with FineLock™ technology. Similar to Autolock, FineLock technology is used to automatically aim the instrument towards a target, however in FineLock mode the instrument uses a much narrower field of view when aiming at a target. This is especially useful in engineering applications such as monitoring and tunneling where multiple targets with very tight spacing are used.

FineLock technology enables the Trimble S7 total station to distinguish between and measure to targets that are placed very close together. Some guidelines for target spacing are in the following table.

| Range (d) | Minimum Target Spacing |
|-----------|------------------------|
| 25 m | 0,1 m |
| 100 m | 0.4 m |
| 200 m | 0.8 m |
| 300 m | 1,2 m |
| 400 m | 1.6 m |
| 500 m | 2,0 m |

To avoid disturbances it is recommended that FineLock mode is not used for distances shorter than 25 m when two prisms at different distances are in the field of view, see [figure 5.6](#). The prism to be measured (prism 1 in the figure) must be between d and $2d$ and the angle between both prisms $> 0,25$ gon (4 mrad).

FineLock is designed for measurements to static targets. It cannot be used to track a moving target such as a robotic rod.

Enable FineLock mode when using the Measure Rounds routine in the application software

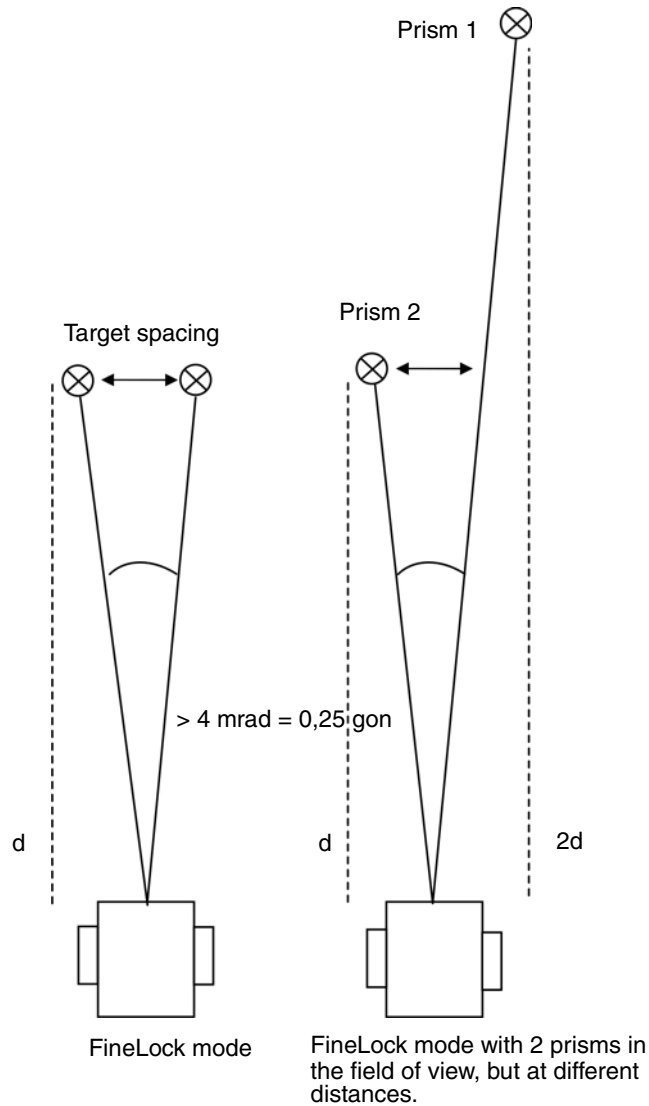

Figure 5.6 Measuring in FineLock mode

Aiming

The adjustment between the two optical axes, the telescope and the tracker, may differ. The difference will make it seem like the instrument does not point towards the center of the prism, when using Autolock, [figure 5.7](#). This is not a problem since the two axes have their own separate collimation data. It is however important to make collimation test for both axes.

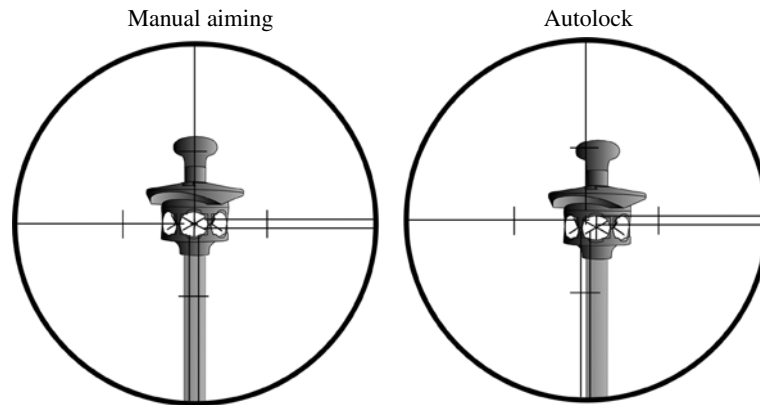

Figure 5.7 Difference between aiming manually and Autolock

How to Check Aiming

You can check how well the instrument is calibrated by measuring toward the prism with and without Autolock and compare the measured angles:

1. Aim manually at a prism and read out the horizontal and vertical angles.
2. Turn on Autolock and let the instrument lock on to the same prism automatically, read out the horizontal and vertical angles.
3. Compare the angles between manual and Autolock aiming.

If the difference between the read out angles is significant, you should carry out both a horizontal and vertical angle collimation adjustment, and a tracker collimation adjustment.

Tracklight

Some of the instrument models are equipped with Tracklight[®]. Tracklight is a visible guide light that enables the rod holder to position themselves into the instrument's current line of sight. The Tracklight can be used during stakeout in all operational modes, and is also of great benefit when operating in robotic mode as a means of checking that the instrument is tracking, or when trying to reacquire lock by walking into the sight line of the tracker, or using the remote joystick control in robotic mode. Tracklight consists of a flashing two-colored light, with each color lying in its own

lateral projection sector. If the rod holder is to the left of the measuring beam, they will see a red flashing light; if they are to the right, they will see a green flashing light. See Figure 5.8

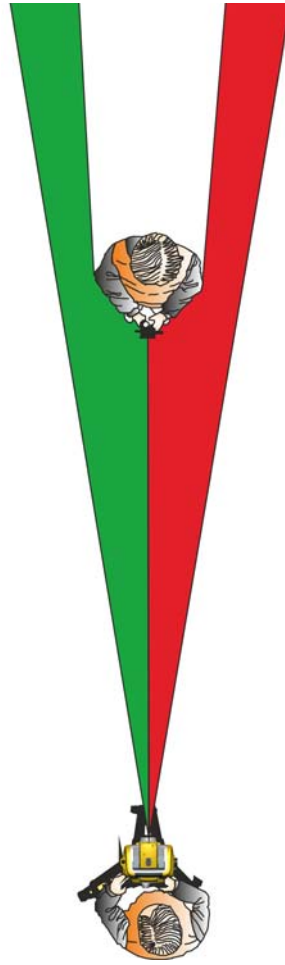

Figure 5.8 Tracklight



Tip – You can use the Tracklight for clearing sight lines and as an aid to find prisms in the dark or unfavorable sighting conditions.



CAUTION – Do not use the laser pointer as an aid when searching for prisms, the reflected light can dazzle your eyes. The reflected light will not damage your eyes, but might be uncomfortable.

Trimble VISION™ Technology

The Trimble S7 Total Station is equipped with Trimble VISION™ Technology. Trimble VISION Technology incorporates a calibrated camera into the instrument which allows live video to be streamed via radio connection to the controller. Trimble VISION Technology can be used to take snap shots for documentation purposes, frame the area to be scanned or give the user the view from the instrument real time in the display of the controller.

The user will be able to see the measured points in the display of the controller.

The user can also use the Trimble VISION Technology to control the instrument from the controllers touch screen. Click on a point in the displayed picture and the instrument will point the telescope towards this point.

For more information please refer to the field software documentation.



CAUTION – Do not make direct sun observations without a camera sun filter foil. this might cause damage to the camera. The camera sun lens foil is available as an accessory, part number 71001011.



CAUTION – Take care when making steep observation, so that the instrument does not accidentally point in to the sun. This might cause damage to the camera.

SureScan Technology

The Trimble S7 Total Station can be equipped with an optional function for surface scanning. This function enables the instrument to measure the shape of a surface for surface modeling and volume calculation etc.

The Trimble SureScan™ Technology optimizes the point grid to enhance the scanning performance.

With a standard scanning grid the distance between the observed points in the grid will be different depending on the distance from the instrument. This gives a scanning grid that is dense close to the instrument and more spread out with an increasing distance between the instrument and the observed point.

SureScan will optimize the point grid so that the scanning grid will have the same density over the scanned area.

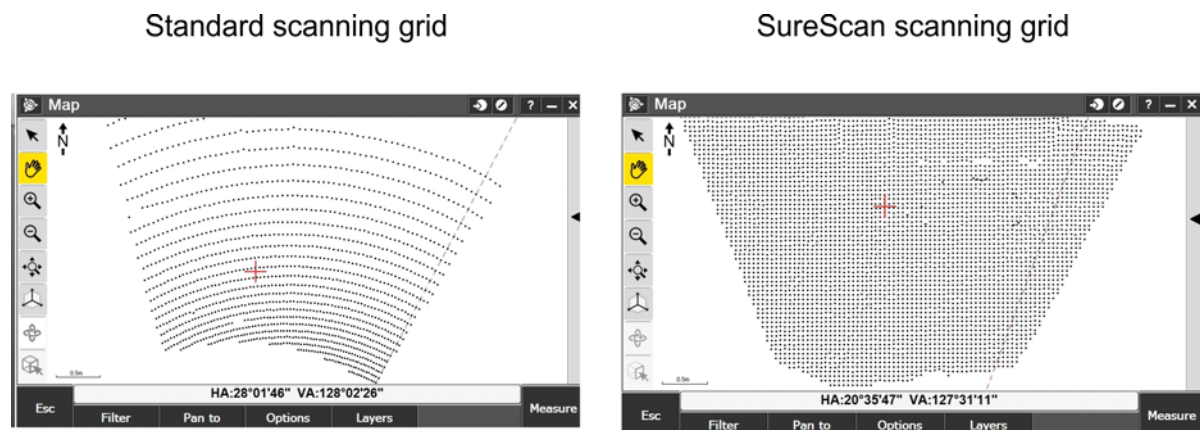

Figure 5.9 Standard scanning grid compared to SureScan scanning grid.

Locate2Protect Technology

The instrument is equipped with Locate2Protect (L2P) technology.

Note – *The L2P module is not activated when delivered from factory. Contact your local service provider to get the L2P module activated.*

With the L2P module activated it is possible to track the location of the instrument in real-time with the web based service Trimble® InSphere™ Equipment Manager.

Apart from knowing where the instrument is located, it is also possible to receive alerts if the instrument leaves a user definable geo fence area and/or if the instrument is subjected to shock or abuse.

The L2P module determines the location of the instrument with a GPS receiver. If the instrument is placed so that the GPS receiver cannot receive signals from the satellites, e.g. indoors, the L2P module determines the location of the instrument with Assisted GPS (A-GPS). A-GPS creates a triangle connection to the nearest cellular towers to determine the location of the instrument.

Airplane Mode

Since the L2P module communicates via cellular technology it is necessary to check local regulations before transporting this instrument by air, see [Transport](#), page V



WARNING – Make sure that the L2P module is inactivated during air transport.

Inactivate L2P Module

With a valid subscription for the L2P module which has been activated through your local service provider it will be possible to activate “Airplane mode” on the L2P module from the InSphere equipment manager web interface.

Without a valid subscription for the L2P module it will not be possible to activate “Airplane mode” on the L2P module from the InSphere equipment manager web interface. In this case you will need to make sure that the internal battery and/or other external power sources are removed from the instrument during transport. If not removed the L2P module will be powered and is able to search for network status and therefore run the risk of violating regulations.

Servo Technology

The instrument is equipped with servo controlled motors to position the instrument and focus the telescope.

Due to the high speed position servo and the SurePoint technology used in the instrument it is important to use a high quality tripod and tribrach. It is also important to set up the tripod in a position for best stability. If the setup, tripod and/or tribrach is/are unstable the instrument servos might oscillate slightly in an effort to compensate for that instability. An unstable setup that could negatively influence the resulting measurement precision. See [Setup](#) on page 28

Position Servo

The Trimble MagDrive™ servo technology is an electromagnetic direct drive system, which gives high turning speeds and accuracy. The frictionless motion removes servo noise and reduces instrument wear. The system provides endless horizontal and vertical motion, including endless fine adjustment. The instrument uses servo when performing a number of different operations such as turning the horizontal and vertical motion knobs, for automatic test and calibration, or when using Autolock technology for robotic surveying. See [Figure 5.10](#)

Note – Due to the high speed servo it is important to use a high quality tripod and tribrach.



Figure 5.10 Position servo

Focus Servo

The instrument is equipped with a focus servo. The focus motion knob is on the side of the instrument for easy access.

The focus knob is connected to a servo motor that is integrated in the telescope. When you turn the focus motion knob, the servo motor adjusts the focusing lens. See [Figure 5.11](#)



Figure 5.11 Focus servo

Power Management

The power management in the instrument can set the instrument to one of three different modes.

- Off mode
- On mode
- Suspend mode

Stand Alone

Instrument only, no Trimble CU connected.

Off Mode

In the off mode the Trigger key LED and face 2 display is off.

Press the Trigger key for 1 second. to turn on the instrument. The instrument will also turn on if you connect a 12 V power supply or data communication cable to the foot connector.

Note – *During startup the Trigger key LED will flash once every second.*

On Mode

In the on mode the Trigger key LED will be on solid, the face 2 display will be on.

To turn off the instrument press the Trigger key for 3 seconds.

The instrument will go to off mode if the battery is very low (battery capacity less than 2%).

If not used for 300 seconds (5 min.) the instrument will go to Suspend mode.

Suspend Mode

In the suspend mode the Trigger key LED will flash once every other second, the face 2 display will be off.

To turn the instrument on press the Trigger key for 1 second or turn on the instrument from a remote application.

To turn the instrument off press the Trigger key for 3 seconds.

In Suspend mode the instrument will turn off automatically at suspend time out. The suspend time out is set in the Trimble CU operating system.

Instrument with Trimble CU Connected

Off Mode

In the off mode the Trigger key LED and face 2 display is off. The Trimble CU will be off or in suspend mode.

To turn the instrument on press the Trigger key for 1 second or press the Trimble CU power key. The instrument will also turn on if you connect a 12 V power supply or data communication cable to the foot connector.

Note – *During startup the Trigger key LED will flash once every second.*

On Mode

In the on mode the Trigger key LED will be on solid, the face 2 display will be on. The face 2 display will be controlled by the Trimble CU application program. The attached Trimble CU will be on and the suspend mode back up battery in the Trimble CU will be charging.

To turn off the instrument press the Trigger key for 3 seconds or press the Trimble CU power key. Depending on the settings in the Trimble CU operating system the instrument will turn off or go to suspend mode.

The instrument will go to suspend mode if the battery is very low (battery capacity less than 2%).

Suspend Mode

In the suspend mode the Trigger key LED will flash once every other second, the face 2 display will be off. The attached Trimble CU will be in suspend mode and the suspend mode back up battery in the Trimble CU will be charging.

To turn the instrument on press the Trigger key for 1 second or press the Trimble CU power key.

To turn the instrument off press the Trigger key for 3 seconds.

This will only turn off the instrument. The Trimble CU will be in suspend mode until suspend time out occurs.



CAUTION – When the Trimble CU is removed from the instrument it is recommended to have the Trimble CU in suspend mode.

Removing the Trimble CU from the instrument when in on mode will not damage the equipment, but files that are being saved or written to when the Trimble CU is being removed might be damaged or lost.

Battery Low Message

If the battery capacity drops too low, the Bat Low message appears in the Trimble CU display window and the instrument shuts down. You must then change the battery within two hours to prevent losing instrument parameters and functions such as instrument height, target height, coordinates, bearing, and dual axis compensation. After that time, the system resets all parameters and functions to default values.

Note – *This safety backup of the instrument parameters and functions will work only when Bat low appears on the display; it will not function if you remove the battery during operation.*

External Communication

Communication (Com) Connector

The communication (COM) Connector on the base of the instrument can be used for external communications to a computer or data collector.



CAUTION – Use only the gray cables with 6-pin Hirose connectors from Trimble when connecting a cable to the instrument.

USB Connector

The USB Connector, on the side of the panel attachment, can be used for communication between an attached TCU and a USB memory.



Figure 5.12 The USB Connector.

Instrument Accessories

In this chapter:

- Trimble Multi Battery Adapter
- Trimble Standard Rod
- Trimble Target ID
- Trimble MultiTrack™ Target
- Trimble Active Track 360 Target
- Trimble Robotic Holder
- Radio
- Radio Antenna Extension Kit

Trimble Multi Battery Adapter

WARNING – Use only the specified battery and cable with the Multi Battery Adapter. Use the adapter only to provide power to the specified Trimble product. Never attempt to charge batteries while they are in the adapter. Observe the warnings in the battery section of the manual.

The Multi Battery Adapter is an external battery adapter that holds and connects up to three instrument batteries. The Multi Battery Adapter has a hook so that the adapter can be attached to the tripod. See Figure 6.1

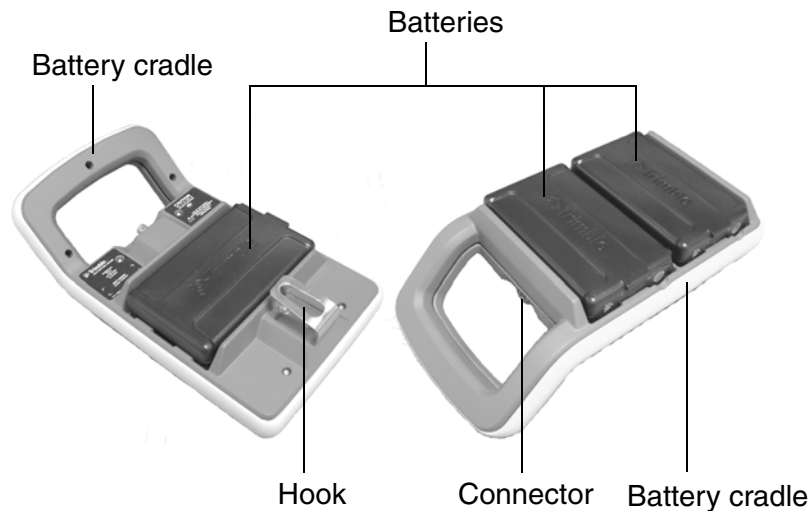

Figure 6.1 Multi Battery Adapter

Connecting the Trimble Multi Battery Adapter

The Trimble Multi Battery Adapter can be connected to the instrument with a standard Trimble 6-pin Hirose battery cable. See Figure 6.2

CAUTION – Use only the gray cables with 6-pin Hirose connectors from Trimble when connecting a cable to the instrument and Multi Battery Adapter.



Figure 6.2 Connecting the Multi battery Adapter

Trimble Standard Rod

The Trimble standard rod is available with the instrument. The rod contains the following features:

- Graduated scale in meters and feet.
- Fixed target height positions
- 360 ° prism comprising 7x25 mm prisms, prism constant 2 mm
- Leveling bubble
- Target id with mini rod (optional) can be fitted

The integrated mini rod can be easily connected to the standard rod or a conventional rod using the mini pole adapter

The target height from the tip of the mini rod to the center of the prism is 0.115 m (0.377 ft.).

Trimble Target ID

The target ID is an optional unit that connects to the Trimble standard rod to transform the prism from a passive target to an active target. See Figure 6.3

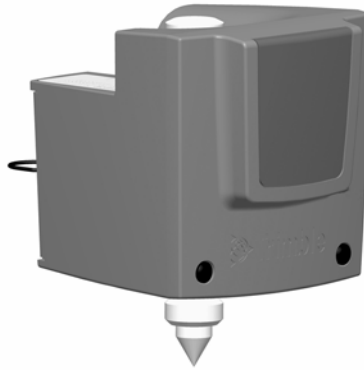

Figure 6.3 Trimble Target ID

You can configure the target ID to eight different IDs, which are then used by the instrument to ensure that the instrument locks onto and tracks only the target with the correct Target ID. Configure the Target ID through its own LED display. See Figure 6.4

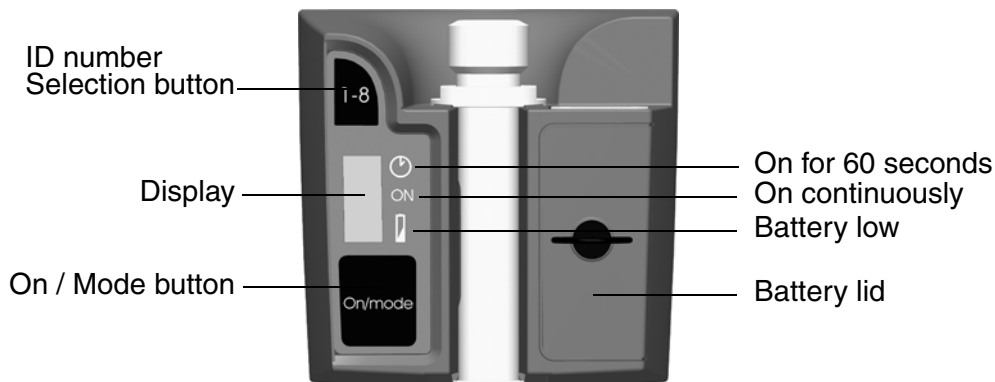

Figure 6.4 Target ID controls

Press the power button one or more times to access the following modes:

- On for 60 seconds
- On continuously
- Off

A bar appears beside the active mode.

When the Target ID is on, the current target ID appears. Press the ID number selection button to change the current target ID number.

The Target ID is powered by two AA size batteries that will operate the unit for approximately 12 hours continuous use. A dot appears beside the battery symbol when battery power is low.

Fitting and Removing the Target ID

1. Screw the adapter and mini rod on to the top of the rod and tighten.
2. Push the Target ID on to the mini rod until it locks in place. The spring lock will hold the Target ID in place.

Removing the Target ID is the reverse operation to fitting.

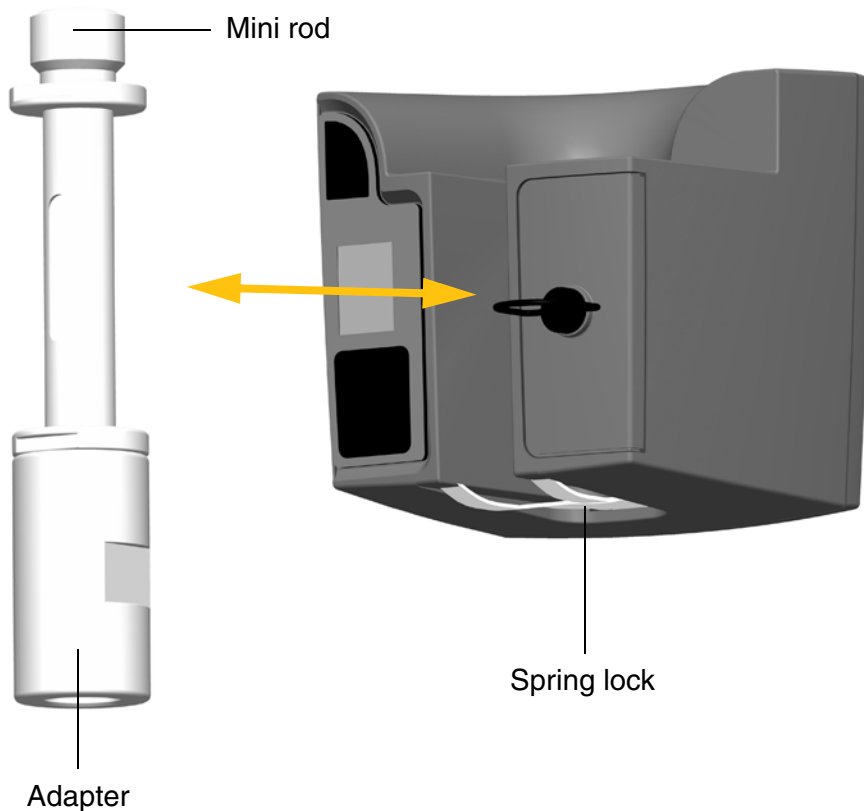

Figure 6.5 Fitting or removing the Target ID.

LED Information

The Target ID has been tested and complies with the regulations for a Class 1 LED product. See Figure 6.4. See Laser Safety on page III.

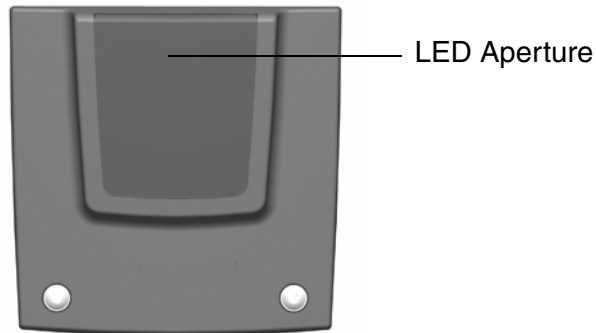

Figure 6.6 Target ID LED Aperture

Changing the Batteries in the Target ID

1. Turn the screw securing the battery lid a quarter of a turn counter-clockwise and then remove the battery lid.
2. Hold the target ID at an angle and let the two used batteries slide out.
3. Insert two new AA size batteries.
4. Fit the battery lid and then secure it by turning the screw a quarter of a turn clockwise. See Figure 6.7

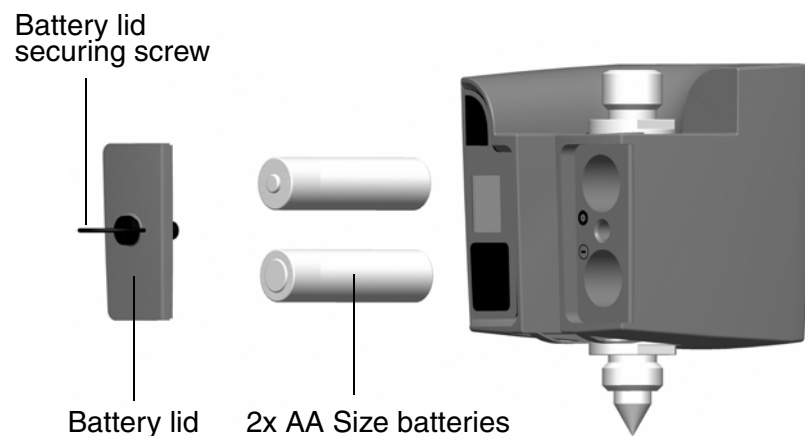

Figure 6.7 Target ID battery change

Trimble MultiTrack™ Target

The Trimble MultiTrack™ target prism technology provides fully coaxial passive and active tracking via an integrated 360° prism ring and 2 active 360° LED rings. The active LED rings support the selection of a unique ID to ensure that 8 different targets can be operated on a single site with full confidence that the correct target is always used.

Features

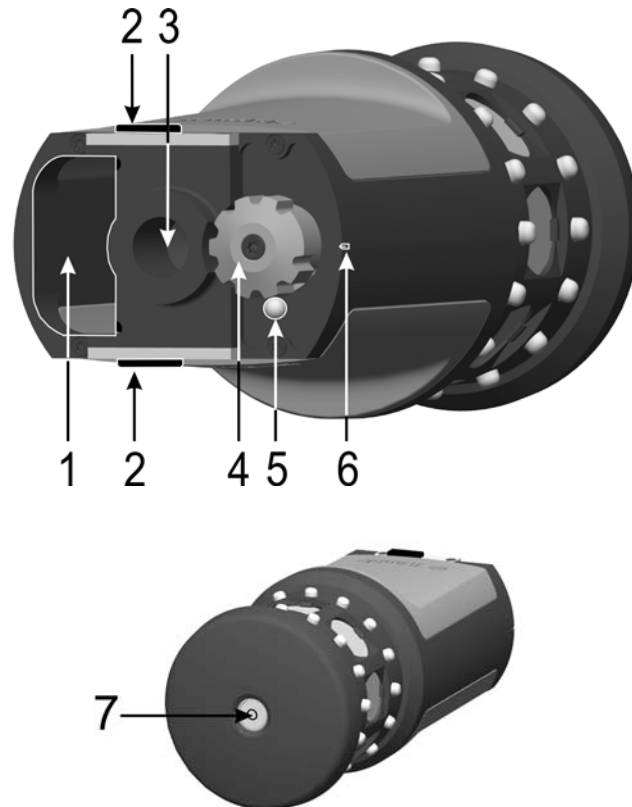

Figure 6.8 Trimble MultiTrack Target features

| Item | Description |
|------|--------------------------------------|
| 1 | Battery compartment |
| 2 | Battery locks |
| 3 | 5/8" Thread |
| 4 | Channel select (on/off switch) |
| 5 | On/Off and battery low indicator LED |
| 6 | Position indicator |
| 7 | Circular level |

Measures

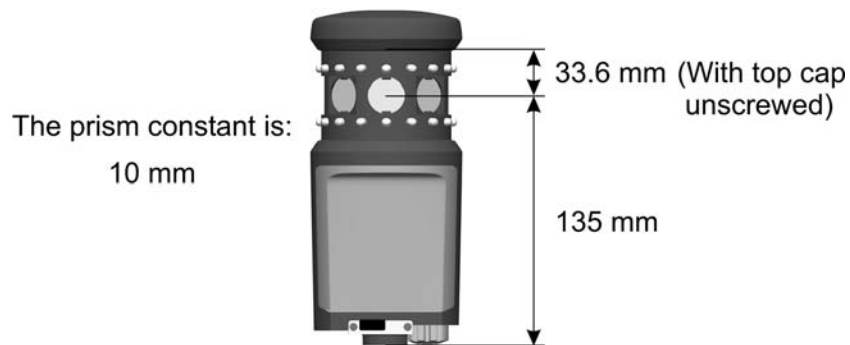

Figure 6.9 Trimble MultiTrack Target measures

Fitting and Removing the Battery

To fit the battery, push the battery in to the battery compartment (1) with the battery connectors (2) facing upwards and inwards until the battery locks clicks (3) in place.

To remove the battery, slide the battery locks open (4), The battery can now slide out of the battery compartment (5).

The battery is a Trimble 7.4 V Li-Ion battery

The Trimble MultiTrack Target will provide active tracking for up to 8 hours from one fully charged battery. When the on/off and battery low indicator LED starts to flash the battery will have approximately 40 minutes operation time remaining.

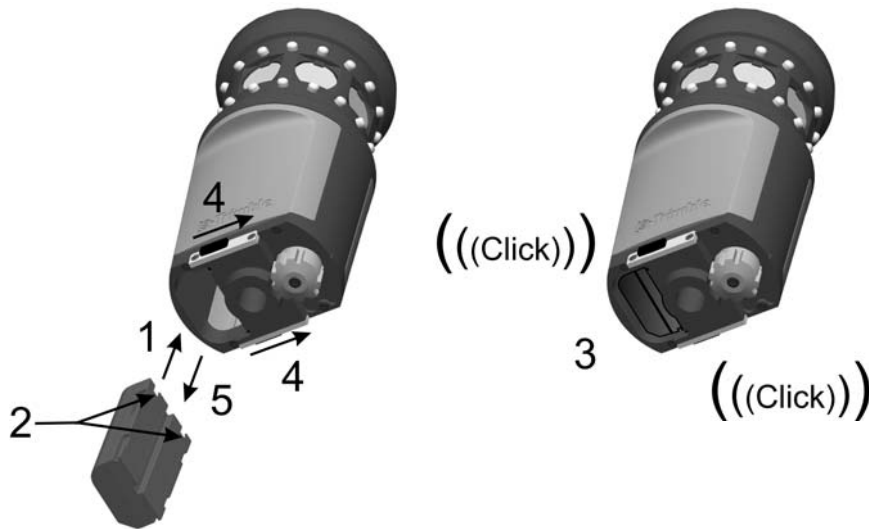

Figure 6.10 Fitting and removing battery on a Trimble MultiTrack Target

Specification Label

To read the specification label unscrew the top cap of the target (1).

Note – The accuracy specification for Active mode is valid within 15° from horizontal. For vertical angles outside of this range it is recommended to use passive mode or to use a tiltable target to ensure the most precise results.

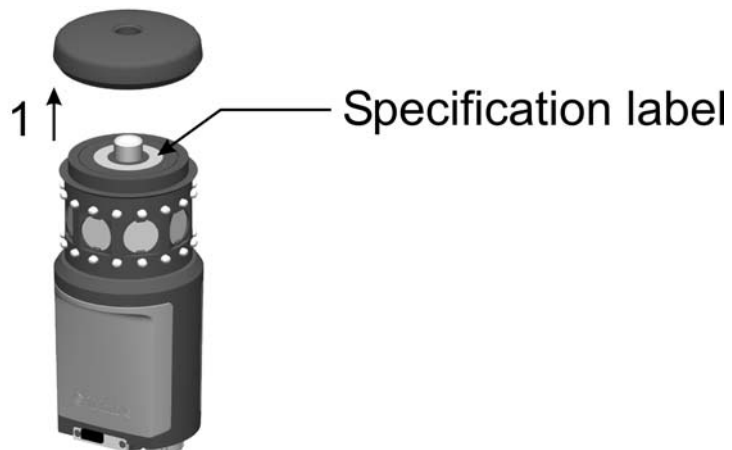

Figure 6.11 Location of Trimble MultiTrack Target specification label

Trimble Active Track 360 Target

The Trimble® Active Track 360 Target is a 360° target for robotic surveying. It is an active target and is designed to be used for robotic measurements.

The Trimble Active Track 360 Target has an integrated 360° active LED ring for tracking and reflective foil for distance measurements.

The Trimble Active Track 360 Target is powered by a Lithium-Ion battery. For permanent installations, it can also be powered via the connector by using an external power supply. The connector is also used if you need to update the target firmware.

You can select eight unique ID channels from the panel to ensure that the correct target is tracked on a site where multiple targets are used.

The Trimble Active Track 360 Target is equipped with Bluetooth wireless technology.

Built in tilt sensors offers the possibility for e-Bubble functionality, if supported by the field software.

Features

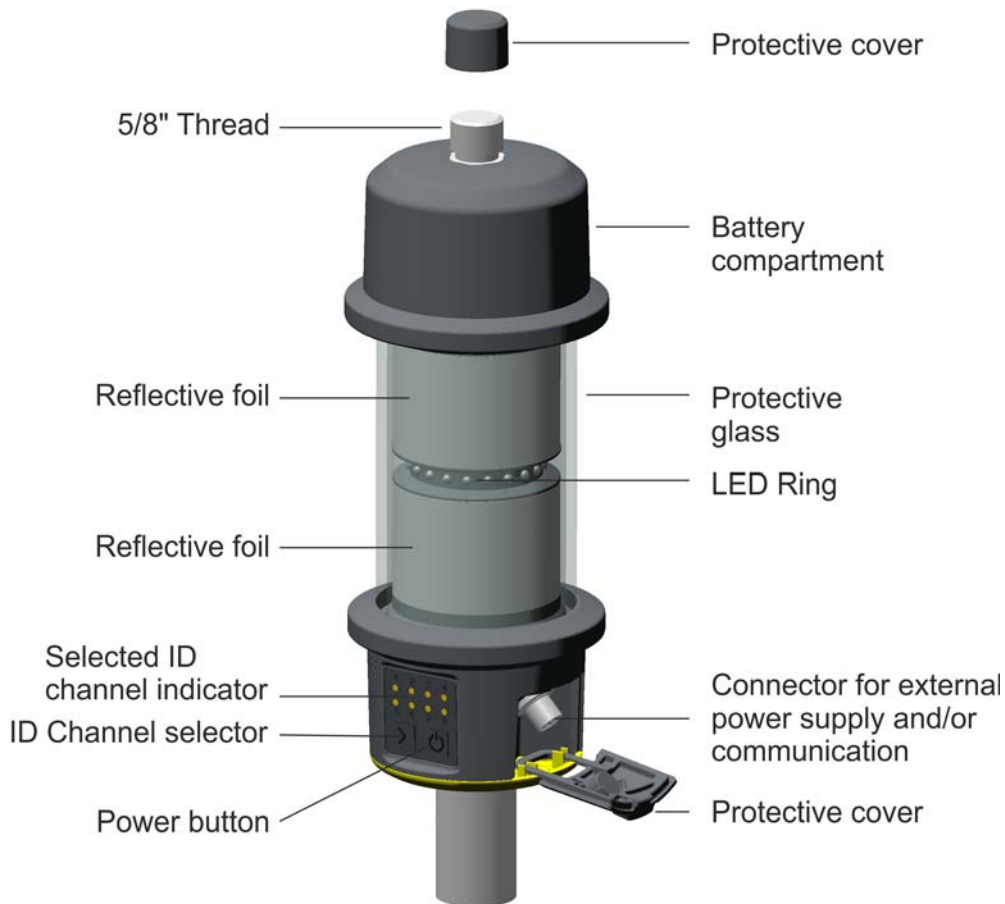

Figure 6.12 Trimble Active Track 360 Target features

Measures

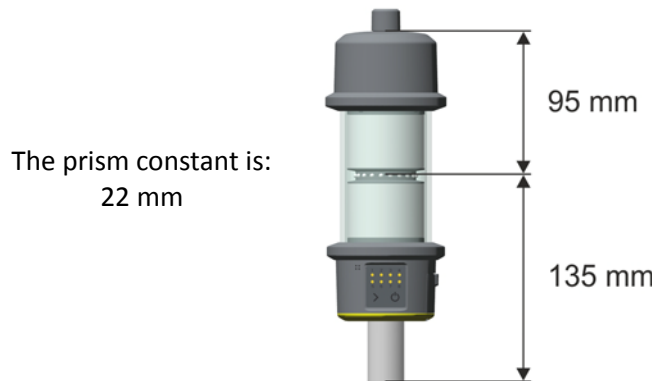

Figure 6.13 Trimble Active Track 360 Target measures

Inserting the battery

When removing the battery cover hold the Active Track 360 Target by the bottom part, not on the protective glass. It is important to keep this glass clean.

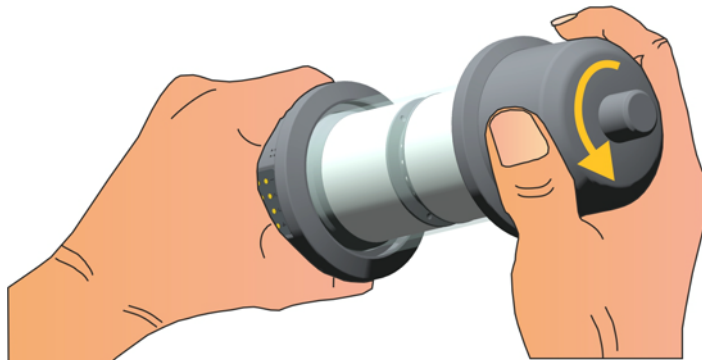

Figure 6.14 How to hold the target when opening the battery cover

1. Turn the battery cover to unlock it.
2. Remove the battery cover.
3. Insert the battery with the battery connectors facing downwards.
4. Attach the battery cover.
5. Turn the battery cover to lock it.

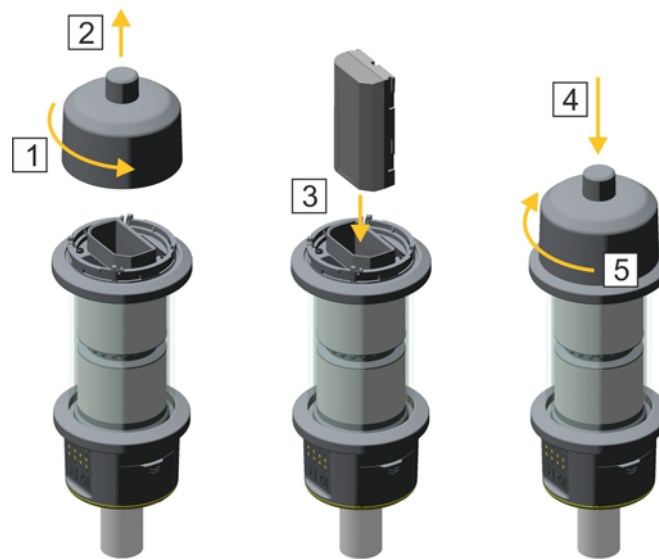

Figure 6.15 Inserting the battery in the Trimble Active Track 360 Target

Turn on the Target

Press the On/Off button to turn on the target.

The target will stay powered on until you press the On/Off button to turn the target off or if the battery is drained.

Battery low is indicated by a flashing LED for the currently selected ID channel.

Select ID Channel

Eight different ID channels can be selected for the Active Track 360 Target.

When the same ID channel selected on the target is selected in the field software, this target is the only one that the Total Station or Spatial Station will lock on to and track.

To select the ID channel, press the ID channel selection button. The ID channel selection steps up one channel for each press from 1 to 8. After ID channel 8 the selection starts again at ID channel 1. It is also possible to select the ID channel from the controller via Bluetooth wireless technology, if supported by the field software.

The selected channel is indicated by an LED.

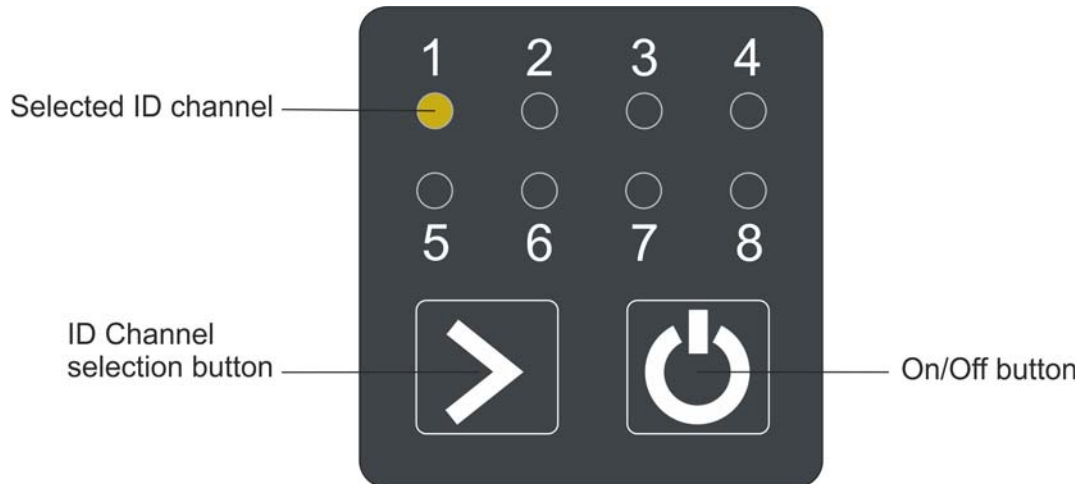

Figure 6.16 Trimble Active Track 360 Target control and indication panel

Attach and Detach

To connect to other Trimble survey equipment and accessories, the Active Track 360 Target is equipped with a male 5/8" thread on top of the target and a female 5/8" thread at the bottom of the target.



CAUTION – Do not tighten or unscrew the Active Track 360 Target by holding the target. Too much force when tightening or unscrewing the Active Track 360 Target might damage the chassis. Use a spanner, adjustable spanner or Key Trimble (Not included), see figure below.



Figure 6.17 Attaching and detaching the Trimble Active Track 360 Target.

Trimble Robotic Holder

The Trimble Robotic Holder holds the Trimble CU when the instrument is operating in robotic mode. See Figure 6.18



Figure 6.18 Trimble robotic holder with Trimble CU and radio

The Trimble Robotic Holder includes the following features:

- Secure Trimble CU connection with quick release
- Secure battery connection with quick release
- Integrated 2.4 GHz radio
- Rugged ergonomic design with safety bumper to protect the Trimble CU
- Quick release from pole connector
- Two ports for external power supply and external communications (USB)

The battery powers the Trimble CU and radio during robotic operation.

You can use a USB memory with the Trimble Robotic Holder to transfer data between the office and the field or between two field devices. Connect the USB memory through the USB dongle cable to the external communications port on the Trimble Robotic Holder. Use Microsoft® Windows® Explorer to transfer the files from the Trimble CU to the memory.



CAUTION – Use only the gray cables with 6-pin Hirose connectors from Trimble when connecting a cable to the Trimble Robotic Holder.

Power Management

Off Mode

In the off mode the Robotic Holder will be off. The Trimble CU will be off or in suspend mode.

To turn on the Robotic Holder and the Trimble CU press the Trimble CU power key. The Robotic Holder and Trimble CU will also turn on if you connect +12 V or data communication cable to the side connector.

On Mode

In the on mode the Robotic Holder will be on. The attached Trimble CU will be on and the suspend mode back up battery in the Trimble CU will be charging.

To turn off the Robotic Holder and the Trimble CU press the Trimble CU power key. Depending on the settings in the Trimble CU operating system the instrument will turn off or go to suspend mode.

The Robotic Holder and the Trimble CU will go to suspend mode if the battery level is low (battery capacity less than 2%).

Suspend Mode

In the suspend mode the Robotic Holder and the attached Trimble CU will be in suspend mode and the suspend mode back up battery in the Trimble CU will be charging.

To turn on the Robotic Holder and the Trimble CU press the Trimble CU power key.

The Robotic Holder and the Trimble CU will be in suspend mode until suspend time out occurs.



CAUTION – When the Trimble CU is removed from the Robotic Holder it is recommended to have the Trimble CU in suspend mode.

To remove the Trimble CU from the instrument when in on mode will not damage the equipment, but files that are being saved or written to when the Trimble CU is being removed might be damaged or lost.

Attaching a Battery

1. Fit the battery on to the hooks on the holder (1).
2. Push the battery on to the holder until it clicks into place (2). See Figure 6.19

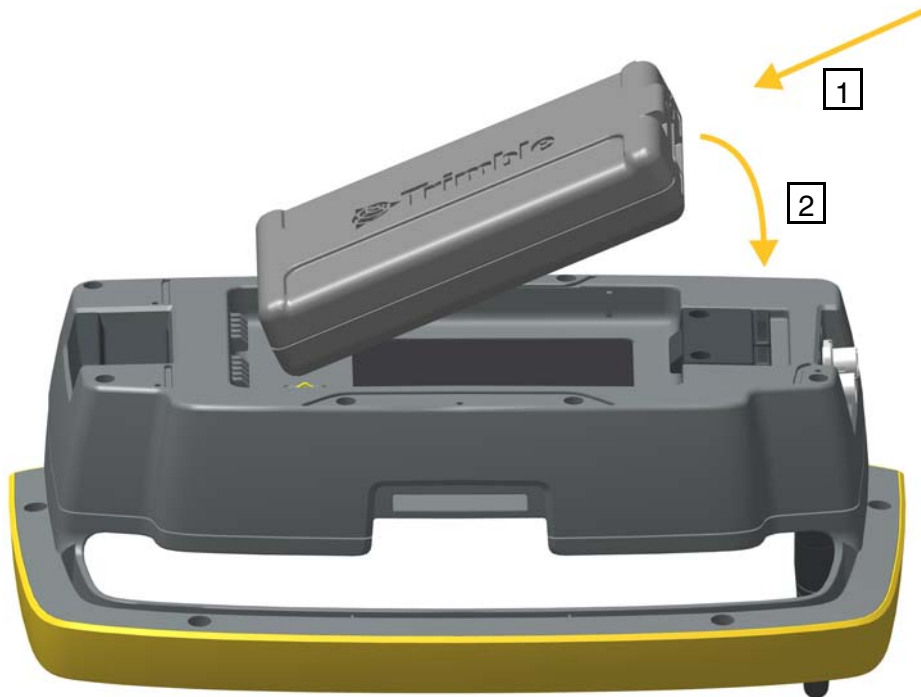

Figure 6.19 Attaching a battery to the Trimble Robotic Holder

Detaching a Battery

1. Pull the battery lock mechanism away from the battery (1).
2. Lift up this side of the battery (2).
3. Remove the battery from the holder (3). See Figure 6.20.

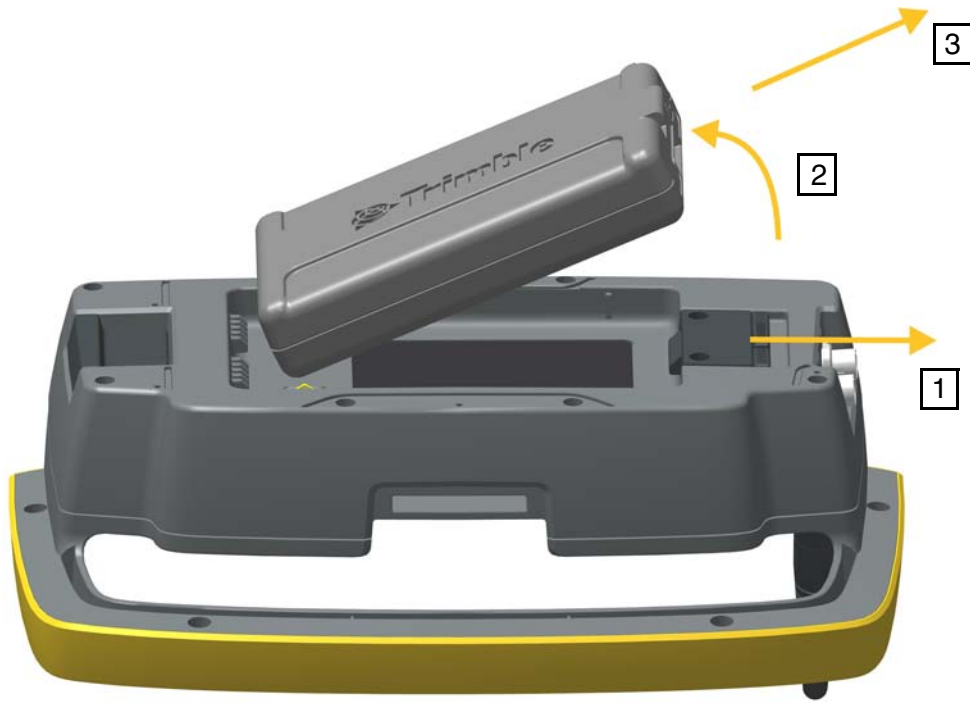

Figure 6.20 Detaching a battery from the Trimble Robotic Holder

Attaching a Trimble CU

1. Hook the top of the Trimble CU over the top edge of the holder (1).
2. Push the bottom of the Trimble CU towards the holder until it locks in place with a click (2),
Figure 6.21.



Figure 6.21 Attach Trimble CU to Trimble Robotic Holder

Detaching a Trimble CU



CAUTION – Make sure to switch off the Trimble CU before it is detached from the instrument.

1. Push the lock release button on the bottom of the Trimble CU (1) and lift the bottom of the Trimble CU away from the holder (2).
2. Unhook the top of the Trimble CU from the top edge of the panel attachment and remove the Trimble CU from the holder (3), Figure 6.22.



Figure 6.22 Detach Trimble CU from Trimble Robotic Holder

Attaching the Trimble Robotic Holder to the Rod

To attach the Trimble Robotic Holder, slide the holder onto the standard rod adapter until the holder locks into place with a click, Figure 6.23.



Figure 6.23 Attaching the Trimble Robotic Holder to the standard rod adapter

Detaching the Trimble Robotic Holder from the Rod

1. To detach the Trimble Robotic Holder from the rod, pull the release mechanism (1)
2. Slide the holder off the rod bracket (2).



Figure 6.24 Detach Trimble Robotic Holder from standard rod adapter



CAUTION – The Trimble CU and Robotic holder are not designed for mounting on a vehicle. For vehicle or ATV always use the TSC3 controller, which has been designed to withstand the shock and vibration conditions associated with that type of use. Mounting the Trimble CU and Robotic holder in these situations is not recommended, and puts your equipment at risk of damage that is not covered by warranty.

Radio

Internal Radio

The instrument has an internal radio to support robotic operations.

The internal radio is a 100 mW radio that operates in the public free 2.4 GHz band. The radio uses frequency hopping technology to reduce radio interference and maintain radio communications in even the harshest RF environment.

The instrument radio baud rate is 115200 bps. This high baud rate reduces the measurement latency, which ensures that a measurement viewed at the pole is received 100 msec after the measurement is sent from the instrument.

To maintain radio communication with the instrument, the Trimble CU at the pole must also be connected to a 2.4 GHz external radio. The radio for the Trimble CU is available as an optional integrated module in the Trimble robotic holder. The radio for the TSC3 is also available as an optional integrated 2.4 GHz radio module.

External Radio 2.4 GHz

An external radio is available as an option for robotic measurements when using a controller not fitted with an internal radio. The External Radio 2.4 GHz uses one 7.4 V Li-Ion battery as power supply. This will give the radio 15 hours with a 2.4 Ah battery. For technical information see [Internal Radio page 108](#).

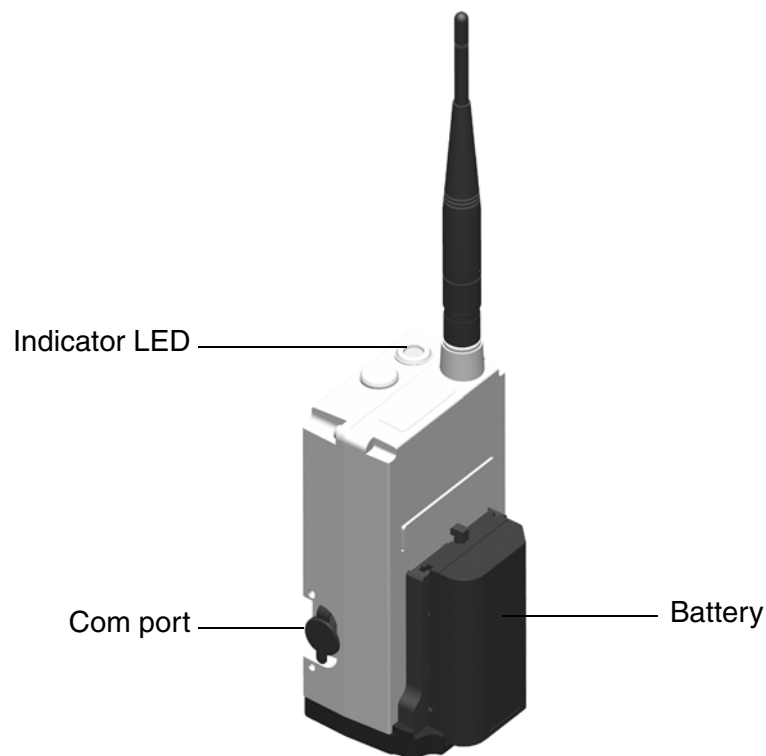

Figure 6.25 External radio 2.4 GHz

For information regarding charging of the battery. See [Charging the Battery on page 14](#)



CAUTION – Always remove the battery from the external radio after use.

Attaching the Battery

To fit the battery to the radio:

1. Fit the battery to the battery holder.

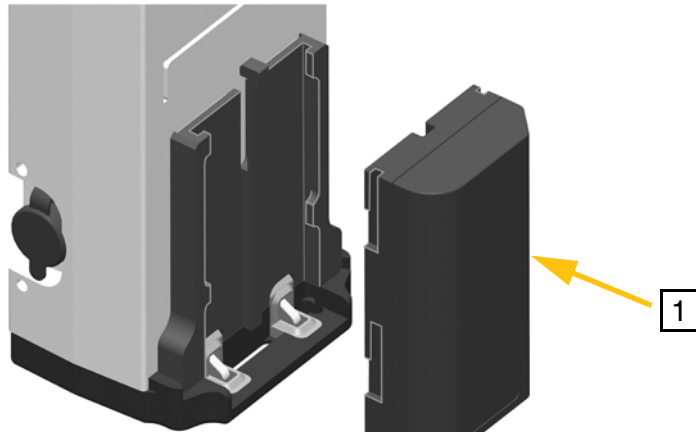

Figure 6.26 Fitting battery to external radio

2. Push the battery downwards until the catch clicks in place.

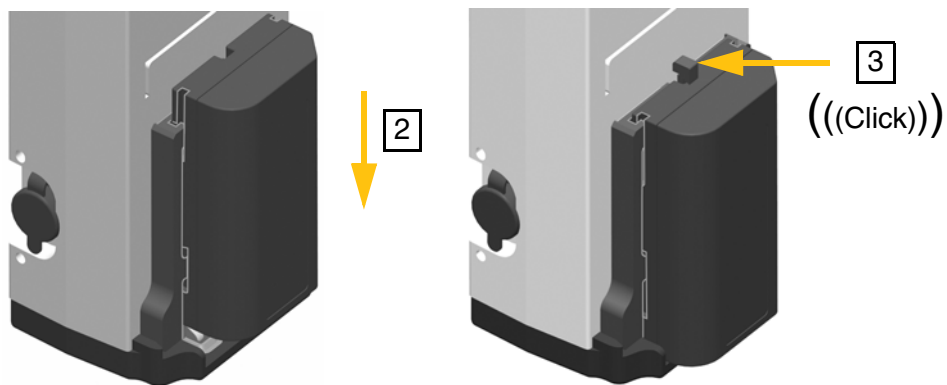

Figure 6.27 Fitting battery to external radio

Detaching the Battery

To remove the battery from the radio:

1. Press the catch towards the radio.
2. Slide the battery upwards.

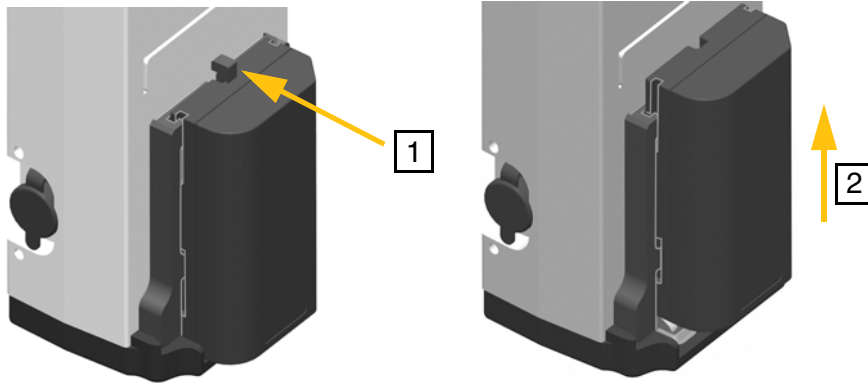

Figure 6.28 Removing battery from external radio

3. Pull the battery away from the battery holder

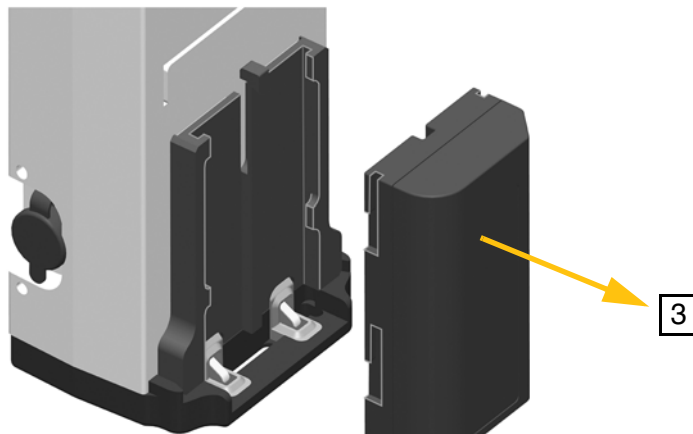

Figure 6.29 Removing battery from external radio

Radio Antenna Extension Kit

For extended radio range it is possible to fit an antenna extension kit to get the radio antenna to a higher position on the rod where it is clear from obstruction by the user or the rod itself. When working at the maximum radio range, this can make a significant difference.

The antenna extension kit consists of:

| Item | Description |
|------|----------------|
| a | Antenna holder |
| b | Antenna cable |
| c | Washer |
| d | Locking washer |
| e | Nut |

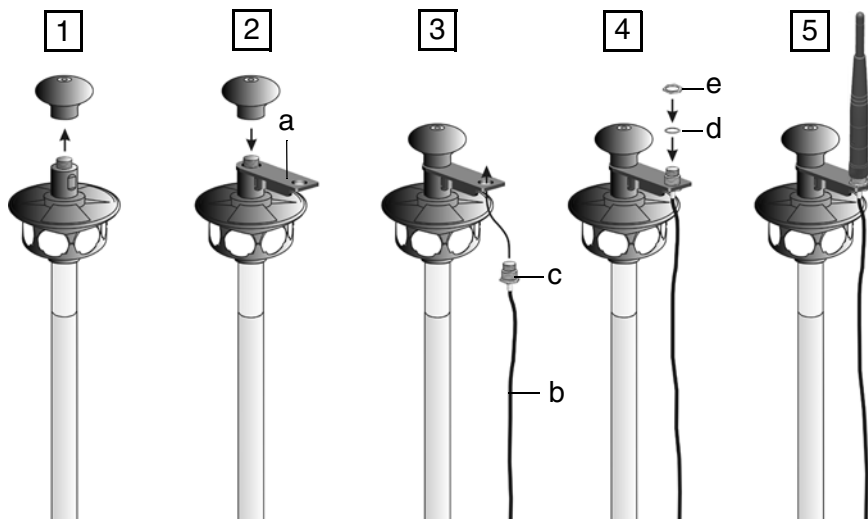

Figure 6.30 Fitting the antenna extension kit.

1. Unscrew and remove the top part of the 360° prism.
2. Fit the antenna holder (a) over the thread and re-fit the top part of the 360° prism.
3. Fit the washer (c) on the antenna cable (b) and fit the antenna cable (b), from underneath, to the antenna holder.
4. Fit the locking washer (d) and nut (e).
5. Fit the antenna on top and connect the antenna cable to the antenna connector on the Trimble Robotic Holder.