



Bed pictured in Tasmanian Oak

## Ned Bed

*The Ned Bed Base is a two-tiered solid timber space saver which affords you the option to run vertically or horizontally in a bedroom. With a small footprint, Ned is an ideal bed for smaller kid's rooms where space is needing to be optimised. Designed to be paired with a bedhead or wall panels to create a finished look.*

### SPECIFICATIONS

<b>Sizes</b>	Single, King Single, Double, Queen
<b>Frame</b>	Solid oak
<b>Finish</b>	Clear satin laquer
<b>Mattress</b>	Standard Australian sizes
<b>Make</b>	100% Australian
<b>Warranty</b>	10 years

### TIMBER + STAIN OPTIONS



### CUSTOM MAKE

Want to customise this furniture item?  
Contact us for a quote [sydney@lillyandlolly.com.au](mailto:sydney@lillyandlolly.com.au)

SINGLE

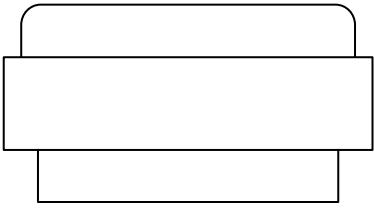

100 cm W

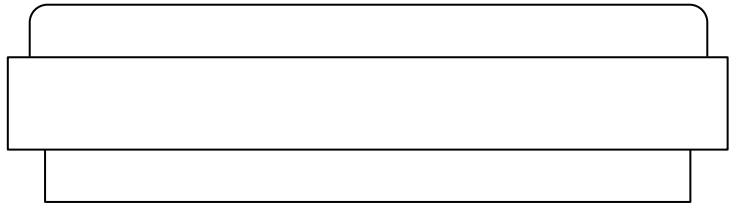

195 cm L

KING SINGLE

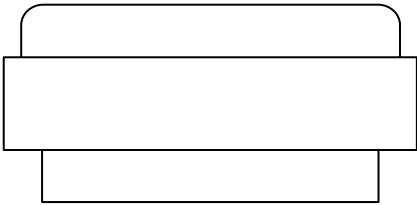

112 cm W

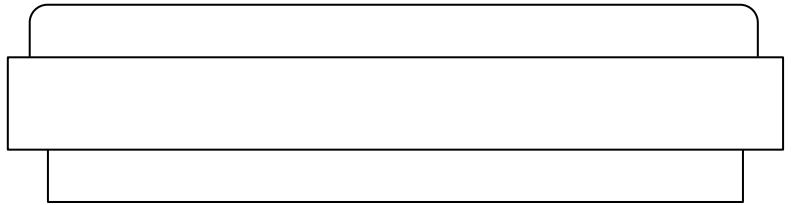

210 cm L

DOUBLE

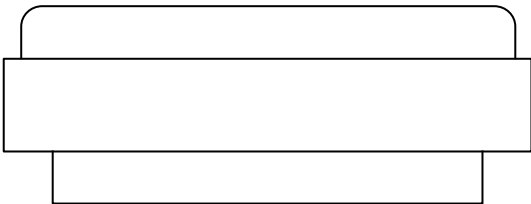

143 cm W

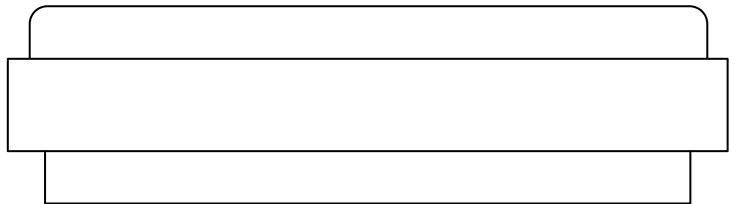

195 cm L

QUEEN

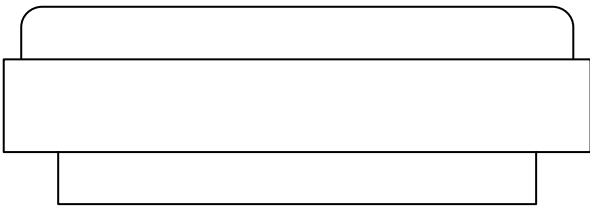

159 cm W

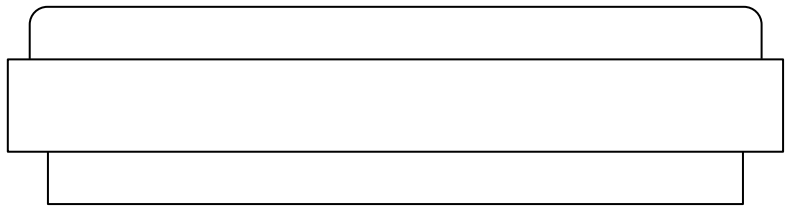

210 cm L



Bedside pictured in Tasmanian Oak

## Ned Bedside

The Ned range was designed as a floating space saver where shelves are mounted off the floor and on the wall. It is one of the best storage concepts, especially for small kid's rooms where floor space is highly valued. Made to order, the wall mounted Ned Bedside has a concealed mounting system to appear as if it were floating.

### SPECIFICATIONS

<b>Frame</b>	Solid oak
<b>Finish</b>	Clear satin laquer
<b>Detail</b>	Concealed split batten attachment
<b>Make</b>	100% Australian
<b>Warranty</b>	10 years

### TIMBER + STAIN OPTIONS

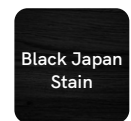

### CUSTOM MAKE

Want to customise this furniture item?  
Contact us for a quote [sydney@lillyandlolly.com.au](mailto:sydney@lillyandlolly.com.au)

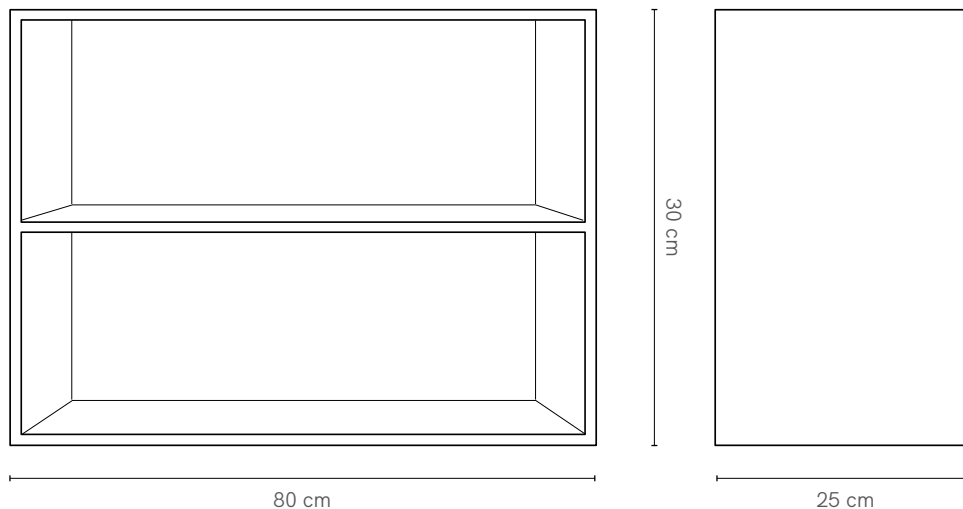



Bookcase pictured in Tasmanian Oak

## Ned Bookcase Two Tier

Perfectly handy bookcases which offer equal amounts of versatility and practicality. Simplifying spaces and offering handy nooks for things to be packed away.

### SPECIFICATIONS

<b>Frame</b>	Oak veneer
<b>Painted Backings</b>	Composite timber
<b>Timber Backings</b>	Timber veneer
<b>Finish</b>	Clear satin laquer
<b>Make</b>	100% Australian
<b>Warranty</b>	10 years

### CUSTOM MAKE

Want to customise this furniture item?  
Contact us for a quote [sydney@lillyandlolly.com.au](mailto:sydney@lillyandlolly.com.au)

1

**CHOOSE YOUR FRAME TIMBER**

Choose from oak timber or stain options.



2

**CHOOSE YOUR BACKINGS**

Choose from timber, stain or colour options.  
You can even specify your own custom colour.

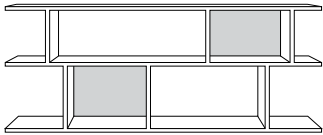

### TIMBER FRAME OPTIONS

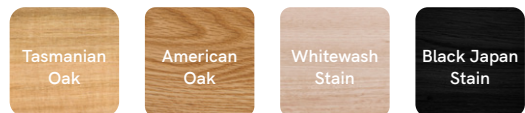

### BACKING OPTIONS

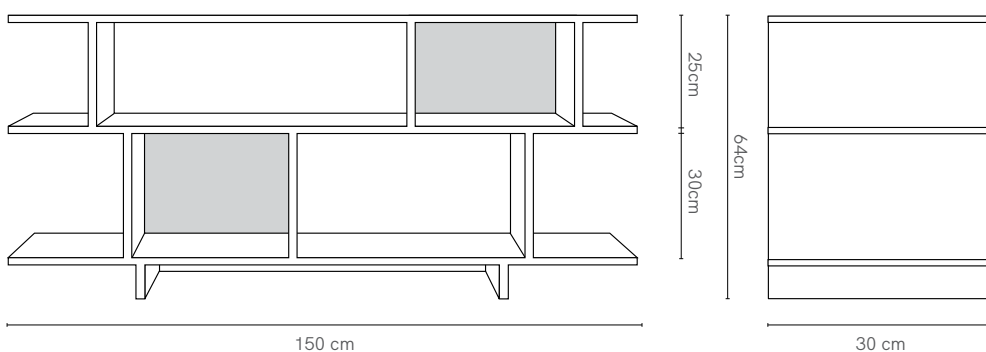



Bookcase pictured in Tasmanian Oak

# Ned Bookcase Three Tier

Perfectly handy bookcases which offer equal amounts of versatility and practicality. Simplifying spaces and offering handy nooks for things to be packed away.

## SPECIFICATIONS

<b>Frame</b>	Oak veneer
<b>Painted Backings</b>	Composite timber
<b>Timber Backings</b>	Timber veneer
<b>Finish</b>	Clear satin laquer

<b>Make</b>	100% Australian
<b>Warranty</b>	10 years

## CUSTOM MAKE

Want to customise this furniture item?  
Contact us for a quote [sydney@lillyandlolly.com.au](mailto:sydney@lillyandlolly.com.au)

**CHOOSE YOUR FRAME TIMBER**

Choose from oak timber or stain options.

1

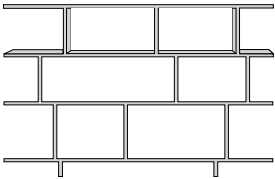

**CHOOSE YOUR BACKINGS**

Choose from timber, stain or colour options. You can even specify your own custom colour.

2

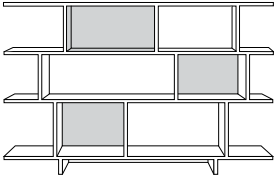

## TIMBER FRAME OPTIONS



## BACKING OPTIONS

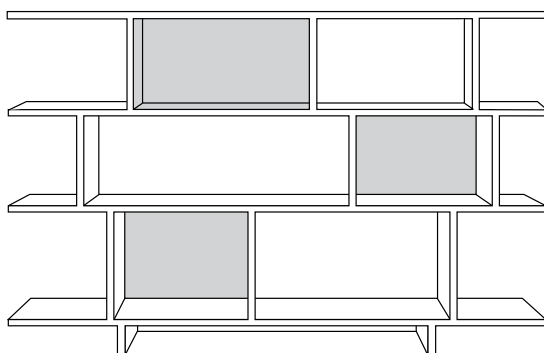

150 cm

30 cm



Shelves pictured in Tasmanian Oak

## Ned Wall Mounted Bookcase

Perfectly handy shelves which offer equal amounts of versatility and practicality. Simplifying spaces and offering handy nooks for things to be packed away. Ned appears to float above the ground, concealing an innovative split-batten attachment system to mount to the wall.

### SPECIFICATIONS

<b>Frame</b>	Oak veneer
<b>Backing</b>	Composite timber
<b>Finish</b>	Clear satin laquer
<b>Make</b>	100% Australian
<b>Warranty</b>	10 years

### CUSTOM MAKE

Want to customise this furniture item?  
Contact us for a quote [sydney@lillyandlolly.com.au](mailto:sydney@lillyandlolly.com.au)

1

**CHOOSE YOUR FRAME TIMBER**

Choose from oak timber or stain options.

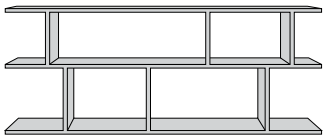

2

**CHOOSE YOUR BACKING**

Choose from timber, stain or colour options. You can even specify your own custom colour.

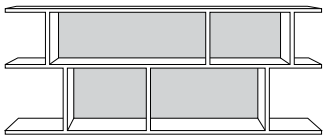

### TIMBER FRAME OPTIONS

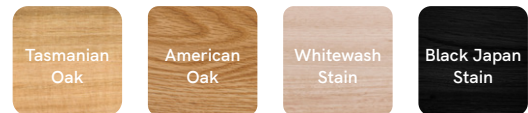

### BACKING OPTIONS

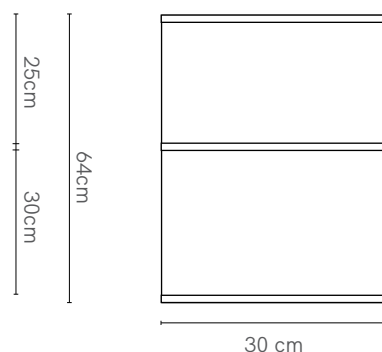
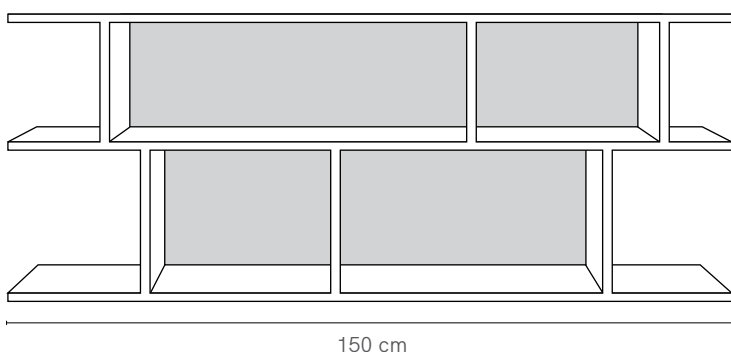



Nooks pictured in Tasmanian Oak

## Ned Wall Nooks

*These perfectly handy wall boxes offer equal amounts of versatility and practicality. Simplifying spaces and offering handy nooks for things to be packed away.*

### SPECIFICATIONS

<b>Sizes</b>	Square, Small, Medium, Large, Extra Large
<b>Frame</b>	Oak veneer
<b>Backing</b>	Composite timber
<b>Finish</b>	Clear satin laquer
<b>Make</b>	100% Australian
<b>Warranty</b>	10 years

### CUSTOM MAKE

Want to customise this furniture item?  
Contact us for a quote [sydney@lillyandlolly.com.au](mailto:sydney@lillyandlolly.com.au)

1

#### CHOOSE YOUR FRAME TIMBER

Choose from oak timber or stain options.

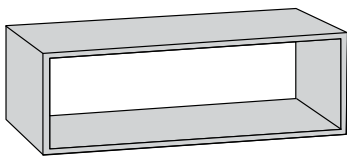

2

#### CHOOSE YOUR BACKING

Choose from timber, stain or colour options. You can even specify your own custom colour.

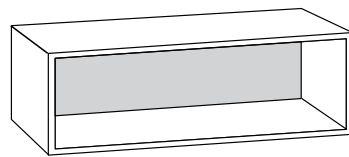

### TIMBER + STAIN OPTIONS (FRAME ONLY)

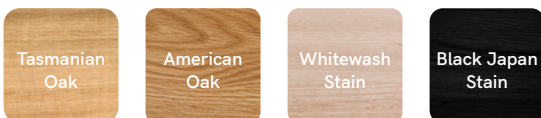

SMALL

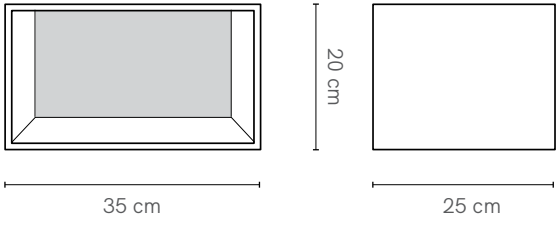

SQUARE

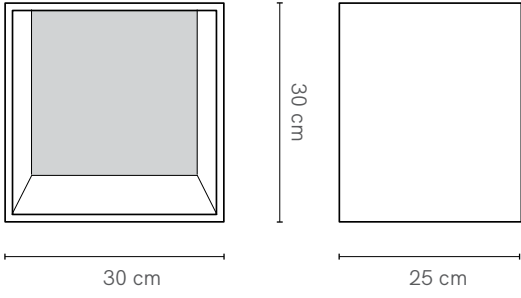

MEDIUM

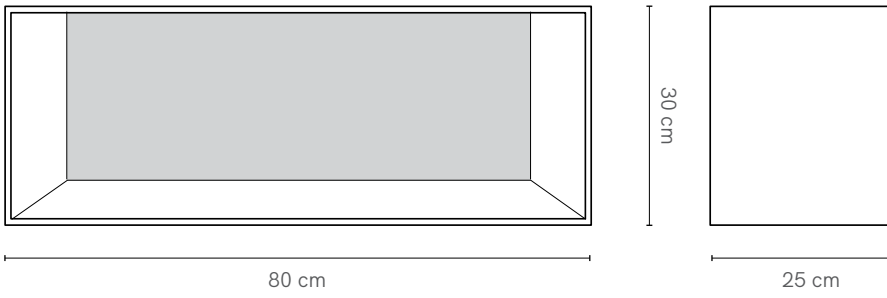

LARGE

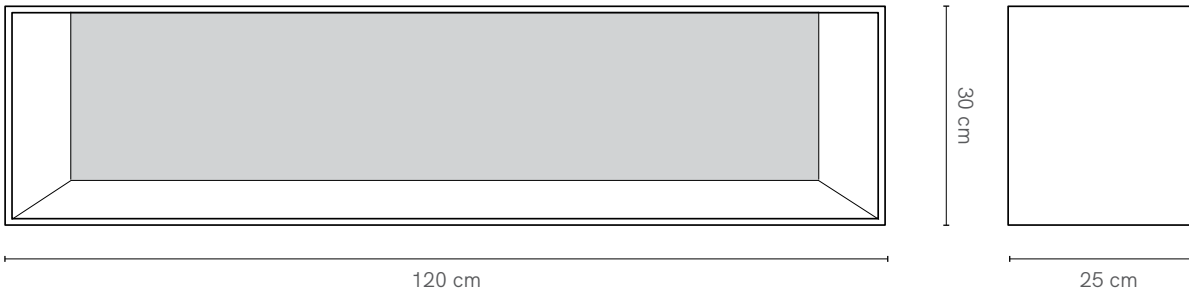

EXTRA

