

XiAN





XiAN | IP50 INDUSTRIAL COMPUTER MODULE

DYNICS XiAN is a very compact computer built with no moving parts and equipped with an aluminum heatsink in an IP50 sealed form factor, featuring Intel® Apollo Lake processor options. With your choice of operating system, storage and optional Wi-Fi the XiAN is a cost-effective entry level industrial computer. The XiAN series ships ready to install on a standard Din Rail. Additional panel and shelf mount brackets are included.

- Fanless (No Moving Parts)
- Aluminum Heatsink
- IP50 Rating
- Graphite Power Coating

PC SPECIFICATIONS

COMPUTER I/O PORTS	3.5" Apollo Lake
1Gb Ethernet Ports	2x
USB 3.0 Ports	2x
Analog VGA Video Ports	1x
HDMI Ports	1x
CPU	Intel® Pentium® N4200
CPU SPEED	Up To 2.5GHz Turbo 2MB Cache (4 Cores, 4 Threads)
MEMORY	Up to 16GB DDR3
STORAGE	128-512GB M.2 Solid State Flash Drive
OPERATING SYSTEM	- Windows® 10 Enterprise IoT LTSB 2016 (64-bit) (Code: E10) - Windows® 10 Pro (64-bit) (Code: W10) - Windows® 10 Enterprise IoT LTSC 2019 (64-bit) (Code: E19) - Windows® 11 Pro (64-bit) (Code: W11) - Windows® 10 Enterprise IoT LTSC 2021 (64-bit) (Code: E21) - Linux Ubuntu (Code: LUB) (Contact DYNICS for more details)
POWER SUPPLY	24VDC Power Entry (3-Pin Quick Disconnect Included) [Contact Dynics for External Power Supply Options]
OPTIONAL TEMPERATURE	Dual Wi-Fi 2.4 GHz (Dual Antennas) Operating: 0°-50°C 32°-122°F Non-Operating: -25°-60°C -13°-140°F
RELATIVE HUMIDITY	Non-Condensing: 20% - 80%
SHOCK RESISTANCE	Operating: 10G Non-Operating: 15G
VIBRATION	Operating: 1.0G from 57~2000Hz Non-Operating: 2.5G from 57~2000Hz
COMPLIANCE	USA: UL Listed, UL 61010-1+UL 61010-2-201, FCC 47CFR Part 15 Class A Canada: CUL Listed, CSA C22.2 No. 61010-1-12+CSA C22.2 No. 61010-2-201, ICES-001, Class A EU: RoHS Directive 2011/65/EU, EN 50581, EMC Directive 2014/30/EU, EN 61326-1, Low Voltage Directive 2014/35/EU, EN 61010-1+EN 61010-2-201
WARRANTY	24-Month limited warranty. Extended warranty available, contact DYNICS for more details.
OPTIONAL ACCESSORIES	<p>PWR-24V-BRK-40W-3PIN 40 Watt AC to DC Desktop Brick Power Supply, 6 Ft US AC Power Cable, 3-PIN DC Cable </p> <p>PWR-24V-2.5ADC-ECO-RAIL ECO-RAIL-2 Industrial DIN Rail Mount 60 W Power Supply, 90-264 VAC Input, 24VDC, 2.5ADC Output </p>

DIMENSIONS, WEIGHT AND POWER CONSUMPTION

	HEIGHT	WIDTH	DEPTH	WEIGHT*	POWER CONSUMPTION**
XiAN	7.1" (180.3mm)	1.93" (48.9mm)	5.1" (129.5mm)	2.05 lbs. (0.93kg)	15 Watts

* Weights are approximate, contact DYNICS for details.

** Power consumption is based on maximum ratings, actual ratings vary significantly based on components used.

XiAN



MECHANICAL DRAWINGS

FRONT VIEW

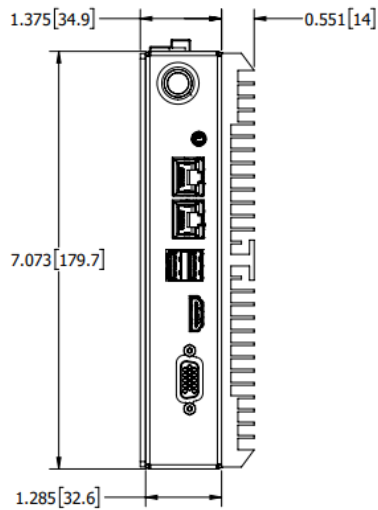

**TOP VIEW
Power Entry**

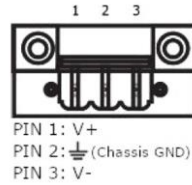
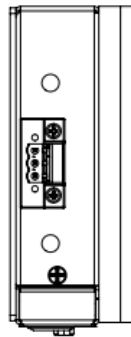

BACK VIEW (DIN Mount)

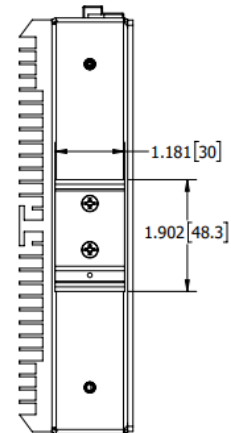

View with optional
Dual Wi-Fi Antennas

BACK VIEW (w/ Panel Mount Brackets)

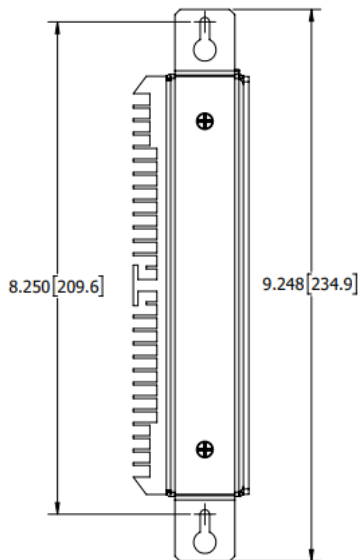

SIDE VIEW (w/ Shelf Mount Brackets)

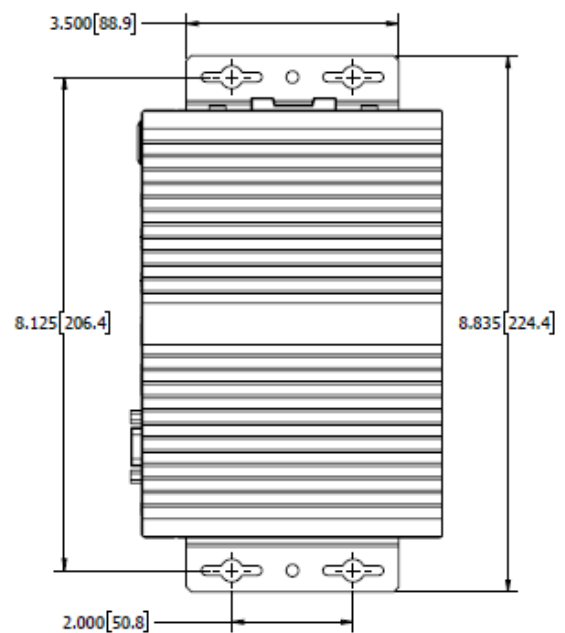

All measurements are in inches and pounds, unless noted. Pictures and drawings are not to scale. Estimated weight may change depending on options. DYNICS Reserves the right to change, modify, upgrade, or discontinue any part of this datasheet without any prior notice.

