

# **JSmart700M Series**

## Operating Instructions





MANUGENJSMART7xxMW - Version 1.00

© 2022 Exor International S.p.A. – Verona, Italy  
Subject to change without notice

The information contained in this document is provided for informational purposes only. While efforts were made to verify the accuracy of the information contained in this documentation, it is provided “as is” without warranty of any kind.

Third-party brands and names are the property of their respective owners.  
[www.exorint.com](http://www.exorint.com)

Software available in these products is based on OpenSource. Visit [oss.exorint.net](http://oss.exorint.net) for more details.



# Table of Contents

Introduction	4
Safety Guide	5
1 Product Overview	6
2 Standards and Approvals	7
3 Technical Specifications	9
4 Technical Data	13
4.1 Dimensions	15
4.2 Installation Environment and Procedure	17
4.3 Safety instruction	18
5 Connections	19
5.1 Ethernet Port	19
6 Power Supply, Grounding and Shielding	20
7 Battery	21
8 Special Instruction for Use	23
9 Getting Started	23
10 Unpacking and Packing Instructions	24



# Introduction

This Operating Instructions manual contains information regarding installation, transportation, storage, use and maintenance of HMI devices.

Following product models are covered by this manual:

Model	Part Number	Description
<b>JSmart707M</b>	JS707GB2U5P1	HMI 7" TFT, 1024x600, PCAP Touch, 8GB Flash memory, PoE Ethernet, Wi-Fi, NFC, JMobile runtime
<b>JSmart710M</b>	JS710GC2U5P1	HMI 10" TFT, 1280x800, PCAP Touch, 8GB Flash memory, PoE Ethernet, Wi-Fi, NFC, JMobile runtime
<b>JSmart715M</b>	JS715GD2U5P1	HMI 15.6" TFT, 1366x768, PCAP Touch, 8GB Flash memory, PoE Ethernet, Wi-Fi, NFC, JMobile runtime
<b>JSmart721M</b>	JS721GE2U5P1	HMI 21.5" TFT, 1920x1080, PCAP Touch, 8GB Flash memory, PoE Ethernet, Wi-Fi, NFC, JMobile runtime
<b>JSmart707M</b>	JS707GB2U5PW	Web HMI 7" TFT, 1024x600, PCAP Touch, 8GB Flash memory, PoE Ethernet, Wi-Fi, NFC, Web Browser
<b>JSmart710M</b>	JS710GC2U5PW	Web HMI 10" TFT, 1280x800, PCAP Touch, 8GB Flash memory, PoE Ethernet, Wi-Fi, NFC, Web Browser
<b>JSmart715M</b>	JS715GD2U5PW	Web HMI 15.6" TFT, 1366x768, PCAP Touch, 8GB Flash memory, PoE Ethernet, Wi-Fi, NFC, Web Browser
<b>JSmart721M</b>	JS721GE2U5PW	Web HMI 21.5" TFT, 1920x1080, PCAP Touch, 8GB Flash memory, PoE Ethernet, Wi-Fi, NFC, Web Browser

# Safety Guide

The manual contains safety standards that must be respected for the personal safety and to avoid damage. Indications of attention are divided into three levels of severity:

**DANGER:** indicates a failure to observe safety rules and such failure may cause death or serious injuries.



**DANGER**

**ATTENTION:** indicates a failure to observe safety rules and that deficiency may cause damage.



**ATTENTION**

**CAUTION:** indicates a failure to observe safety rules and that deficiency may cause defects to the equipment or inconsistencies.



**CAUTION**

# 1 Product Overview

JSmart700M products are ideal for field installation in critical areas. High-resolution displays and multitouch PCAP touchscreen with a robust glass front; touchscreen/display bonding for fidget optical performance.

Power-over-Ethernet (PoE) for maximum simplicity of connection using standard CAT5 wiring. The availability of a Wi-Fi interface enhances the device integration, while the NFC broadens the device applications. Full IP protection with the use of dedicated connectors for the maximum flexibility of installation, from mounting arm to a simple M22 hole.

The JSmart700M product family has been optimized for use as an embedded browser or as a JMobile HMI device.

Jsmart700M Web version are the ideal choice for all demanding IoT edge applications in factory, marine and building automation where powerful and performing HTML5 web browser is needed.

The JSmart700M Web products include a Chromium based HTML5 browser supporting kiosk mode operation. Supports Corvina Cloud secure connectivity.

- Chromium based HTML5 Browser
- Easy to use browser setting application



## 2 Standards and Approvals

The products have been designed for use in an industrial environment in compliance with the 2014/53/EU Directive.

The products have been designed in compliance with:

EN 61000-6-4  
EN 61000-6-2  
EN 61000-6-3  
EN 61000-6-1  
ETSI EN 301 489-1  
ETSI EN 301 489-3  
ETSI EN 301 489-17  
ETSI EN 300 328  
ETSI EN 300 330  
EN 62311 \*  
EN 61010-1  
EN 61010-2-201

\* Standard radio signal and minimum distance from the body calculated according to EN 62311

Standard radio signal	WiFi 2,4GHz
Minimum distance from the body (cm)*	2

\* The WiFi antenna is positioned behind the black band above the display.

The products are in compliance with the Restrictions on Certain Hazardous Substances (RoHS) Directive 2011/65/EU

In compliance with the above regulations the products are CE marked.

# 2 Standards and Approvals

## Product Identification

The product may be identified by the indications in the back cover. You will have to know the type of unit you are using for correct usage of the information contained in the guide. An example of the information reported is shown below:

EXOR JSmart707M  
IEEE802.3af PoE 11W max.

MAC-ID: 0030D8068303  
S.N.: AA000 11FV000000561AA  
2127

IND. CONT. EQ  
also listed for  
IND. CONT. EQ FOR HAZ. LOC.  
CLASS I DIV 2 - GROUPS A, B, C, D

Operating Temperature Code T5  
-20°C ≤ Tamb ≤ +55°C  
For use on a flat surface of a type 1  
or 12 or 4X enclosure or equivalent

Exor International S.p.A.  
Via Monte Fiorino 9  
IT-37057 San Giovanni Lupatoto (VR)

product model name	JSmart707M
year/week of production	2127
serial number	AA00011FV000000561AA
manufacturer address	Exor International S.p.A. Via Monte Fiorino 9 IT-37057 San Giovanni Lupatoto (VR)



## 3 Technical Specifications

<b>Touchscreen technology</b>	Projected capacitive - Multitouch	
<b>Back-up battery</b>	3V 7mAh Vanadium-Lithium, rechargeable, not user-replaceable, model VL1220.	
<b>Flash</b>	8GB	
<b>RAM</b>	2GB	
<b>Hardware clock</b>	Clock/Calendar with back-up battery	
<b>Accuracy RTC (at 25°C)</b>	<100ppm	
<b><i>Environmental conditions</i></b>		
<b>Operating temperature (surrounding air temperature)</b>	-20 ÷ +55°C (vertical installation)	EN 60068-2-14
<b>Storage temperature</b>	-30 ÷ +80°C (JSmart707, 710) -20 ÷ +70°C (JSmart715, 721)	EN 60068-2-1 EN 60068-2-2 EN 60068-2-14
<b>Operating and storage humidity</b>	5 ÷ 85 % RH non-condensing	EN 60068-2-30
<b>Vibrations</b>	5 ÷ 9 Hz, 7 mm <sup>p-p</sup> 9 ÷ 150 Hz, 1 g	EN 60068-2-6
<b>Shock</b>	± 50 g, 11 ms, 3 pulses per axis	EN 60068-2-27
<b>Protection class</b>	IP67 (requires appropriate connectors and cables)	EN 60529
<b><i>Electromagnetic Compatibility (EMC)</i></b>		
<b>Radiated disturbance test</b>	Class A	CISPR 22 CISPR 16-2-3
<b>Electrostatic discharge immunity test</b>	8 kV (air electrostatic discharge) 4 kV (contact electrostatic discharge)	EN 61000-4-2
<b>Radiated, radio-frequency, electromagnetic field immunity test</b>	80 MHz ÷ 1 GHz, 10V/m 1,4 GHz ÷ 2 GHz, 3 V/m 2 GHz ÷ 2.7 GHz, 1 V/m	EN 61000-4-3
<b>Burst immunity test</b>	± 2 KV dc power port ± 1 KV signal line	EN 61000-4-4
<b>Surge immunity test</b>	± 0,5 KV dc power port (line to earth) ± 0,5 KV dc power port (line to line) ± 1 KV signal line (line to earth)	EN 61000-4-5
<b>Immunity to conducted disturbances induced by radiofrequency field</b>	0.15 ÷ 80 MHz, 10V	EN 61000-4-6
<b>Power frequency magnetic field immunity test</b>	Enclosure, 50/60Hz, 30A/m	EN 61000-4-8

# 3 Technical Specifications

## Durability information

### Backlight service life (LED type)

40000 Hrs. or more  
 (Time of continuous operation until the brightness of the backlight reaches 50% of the rated value when the surrounding air temperature is 25°C. Extended use in environments where the surrounding air temperature is 40°C or higher may degrade backlight quality/reliability/durability.)

## Viewing angles

For the viewing angles values (U,D,R,L) of the display types, see the technical data of the respective device.

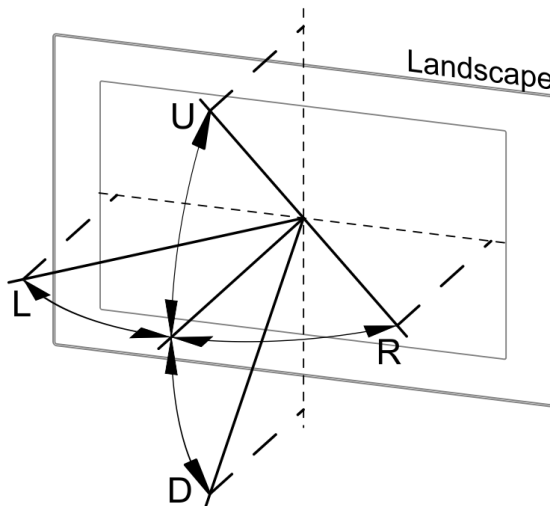

Legend:	Display viewing angle
U	From top
D	From bottom
L	From left
R	From right

The viewing angles are specified for the horizontal (L,R) and vertical (U,D) axes in reference to the vertical axis of the display. The specified viewing angles above always refer to the standard mounting orientation.

## 3 Technical Specifications

### Surface resistance

Chemical resistance of the front glass for an exposure time of 24 hours without visible changes:

- Betadine (10% Povidone Solution)
- Cola
- Electrode Gel/Paste
- Hydrogen Peroxide (3% Solution)
- NaCl (0.9% Solution)
- Coffee
- Dextrose (5% Glucose Solution)
- Hydrogen chloride (0.5% Solution PH=1)
- Isopropyl Alcohol
- Sodium Hypochlorit
- Ethyl Alcohol (70%-90%)
- Quaternary ammonium compound

# 3 Technical Specifications

## Properties multitouch PCAP touchscreen

Number of fingers	5
Glove operation	Yes
Passive stylus pens	Yes
Active stylus pens	No
Hardened front glass	Yes

## Operation with gloves

Projected capacitive touch screens (PCAP) are suitable for operation with or without gloves. A large number of gloves (rubber gloves, light/heavy leather gloves, disposable latex gloves, etc.) are supported. Due to the variety of commercially available gloves, however, EXOR cannot guarantee all types.

## 4 Technical Data

Model	JSmart707M	JSmart710M	JSmart715M
<b>Display / Backlight</b>	TFT Color / LED	TFT Color / LED	TFT Color / LED
<b>Colors</b>	16M	16M	16M
<b>Resolution</b>	1024X600	1280X800	1366X768
<b>Diagonal (inches)</b>	7" widescreen	10.1" widescreen	15.6" widescreen
<b>Viewing angles horizontal</b>	Direction L / Direction R Typ. 75°	Direction L / Direction R Typ. 85°	Direction L / Direction R Typ. 80°
<b>Viewing angles vertical</b>	Direction U / Direction D Typ. 75°	Direction U / Direction D Typ. 85°	Direction U / Direction D Typ. 80°
<b>Dimming</b>	yes	yes	yes
<b>CPU</b>	64-bit RISC Quad core - 1.6 GHz	64-bit RISC Quad core - 1.6 GHz	64-bit RISC Quad core - 1.6 GHz
<b>Operating System</b>	Linux	Linux	Linux
<b>Flash</b>	8GB	8GB	8GB
<b>RAM</b>	2GB	2GB	2GB
<b>Real Time Clock</b>	yes	yes	yes
<b>Ethernet port</b>	10/100 PoE 802.3af/at	10/100 PoE 802.3af/at	10/100 PoE 802.3af/at
<b>USB port</b>	1 (Host v. 2.0, request special connector)	1 (Host v. 2.0, request special connector)	1 (Host v. 2.0, request special connector)
<b>Power supply</b>	802.3af	802.3af	802.3at
<b>Current consumption</b>	12W	14W	23W
<b>Battery</b>	rechargeable	rechargeable	rechargeable
<b>Weight</b>	0.7 Kg	1.2 Kg	4.0 Kg

## 4 Technical Data

Model	JSmart721M
<b>Display / Backlight</b>	TFT Color / LED
<b>Colors</b>	16M
<b>Resolution</b>	1920X1080
<b>Diagonal (inches)</b>	21.5" widescreen
<b>Viewing angles horizontal</b>	Direction L / Direction R Typ. 89°
<b>Viewing angles vertical</b>	Direction U / Direction D Typ. 89°
<b>Dimming</b>	yes
<b>CPU</b>	64-bit RISC Quad core - 1.6 GHz
<b>Operating System</b>	Linux
<b>Flash</b>	8GB
<b>RAM</b>	2GB
<b>Real Time Clock</b>	yes
<b>Ethernet port</b>	10/100 PoE 802.3af/at
<b>USB port</b>	1 (Host v. 2.0, request special connector)
<b>Power supply</b>	802.3bt
<b>Current consumption</b>	35W
<b>Battery</b>	rechargeable
<b>Weight</b>	6.0 Kg

# 4 Technical Data

## 4.1 Dimensions

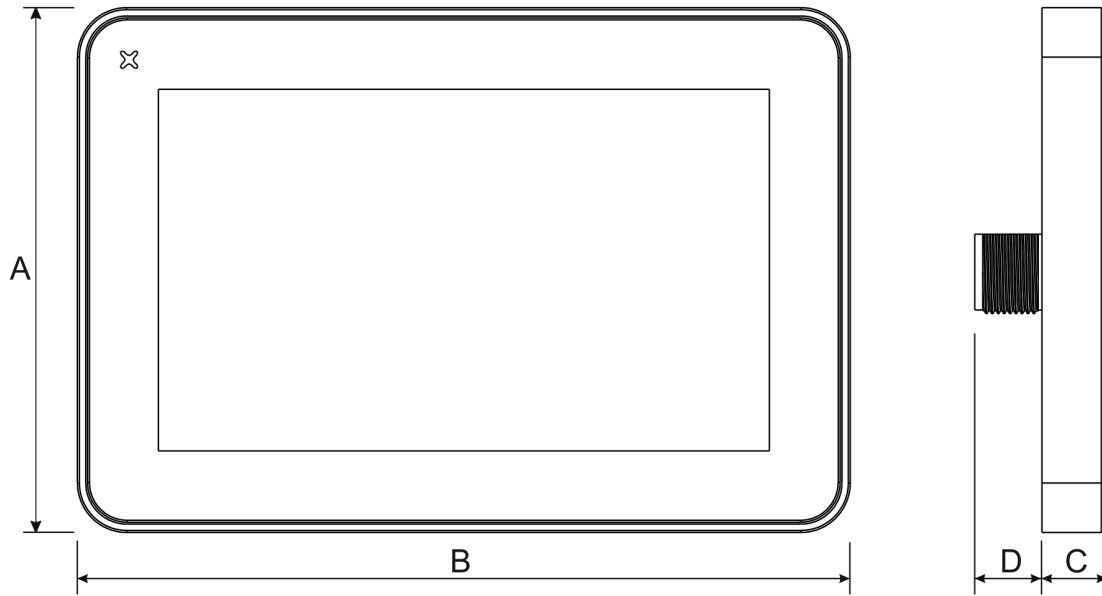

MODEL	A	B	C	D
JSmart707M	131.6mm/5.18"	195.2mm/7.68"	16,5mm/0.64"	17mm/0.66"
JSmart710M	183.1mm/7.20"	264.5mm/10.41"	16,5mm/0.64"	17mm/0.66"
JSmart715M	248mm/9.76"	398.6mm/15.69"	26,5mm/1.04"	17mm/0.66"
JSmart721M	325.6mm/12.81"	534.1mm/21.02"	26,5mm/1.04"	17mm/0.66"

# 4 Technical Data

Rear view

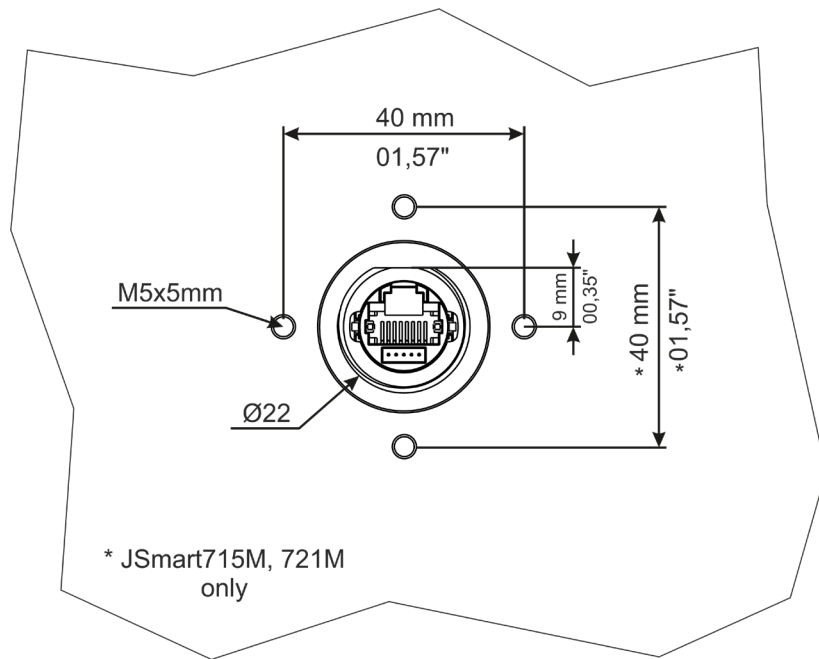



# 4 Technical Data

## 4.2 Installation Environment and procedure

Avoid prolonged exposition to direct sunlight to avoid the risk of overheating the device.

The equipment is not intended for installation in contact with corrosive chemical compounds. Check the resistance of the front panel to a specific compound before installation.

Do not use tools of any kind (screwdrivers, etc.) to operate the touch screen of the panel.

IP67 is guaranteed only if a JSCAxxxx cable is used and if:

- max deviation from the plane surface to the cut-out:  $\leq 0.5\text{mm}$
- thickness of the case where is mounted the equipment: from 1,5mm to 3mm
- max surface roughness where the gasket is applied:  $\leq 120\ \mu\text{m}$

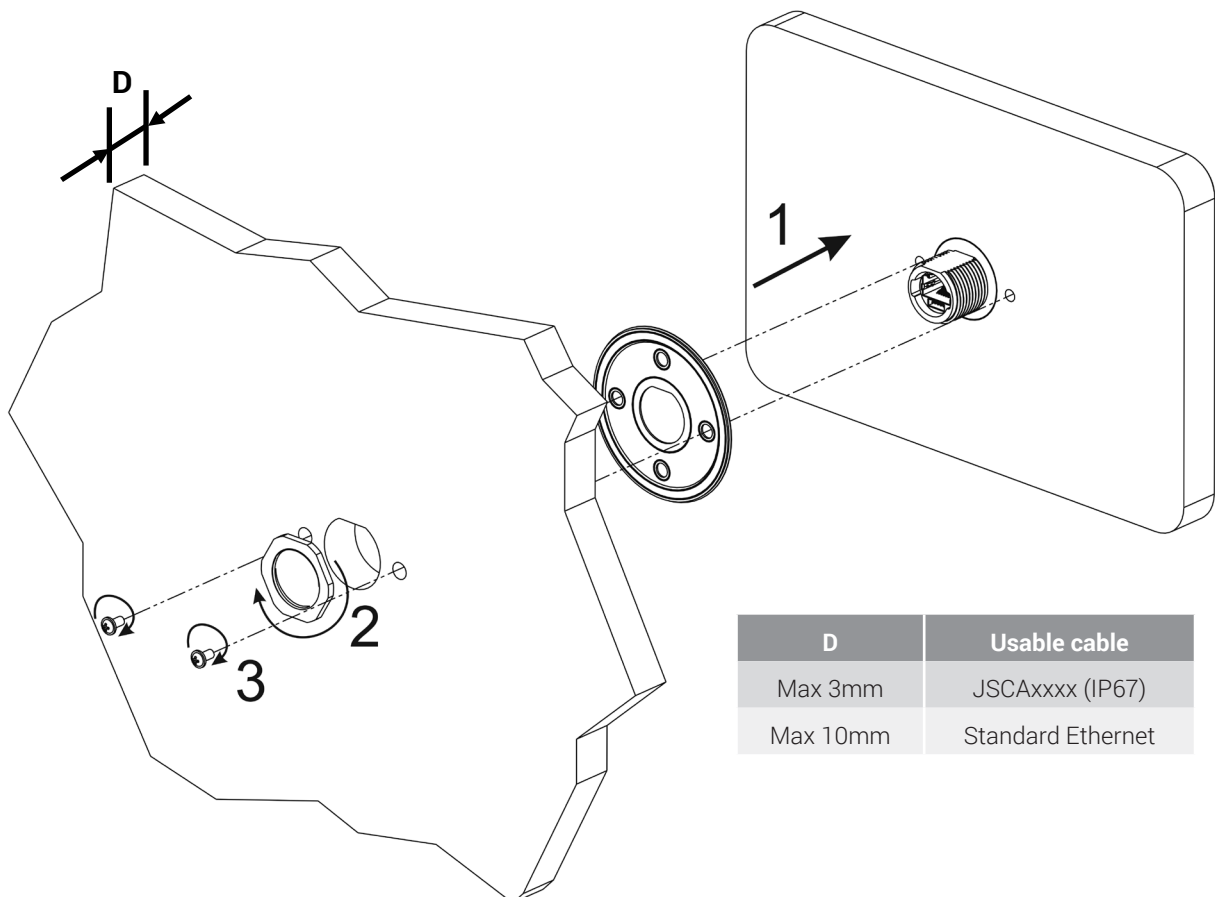

D	Usable cable
Max 3mm	JSCAxxxx (IP67)
Max 10mm	Standard Ethernet

**CAUTION**  
Tightening torque: 1000Ncm for nut, 130Ncm for screws

## 4 Technical Data

### 4.3 Safety instruction



For all installation notes, please refer to the Installation Guide provided with the product.

# 5 Connections

## 5.1 Ethernet Port

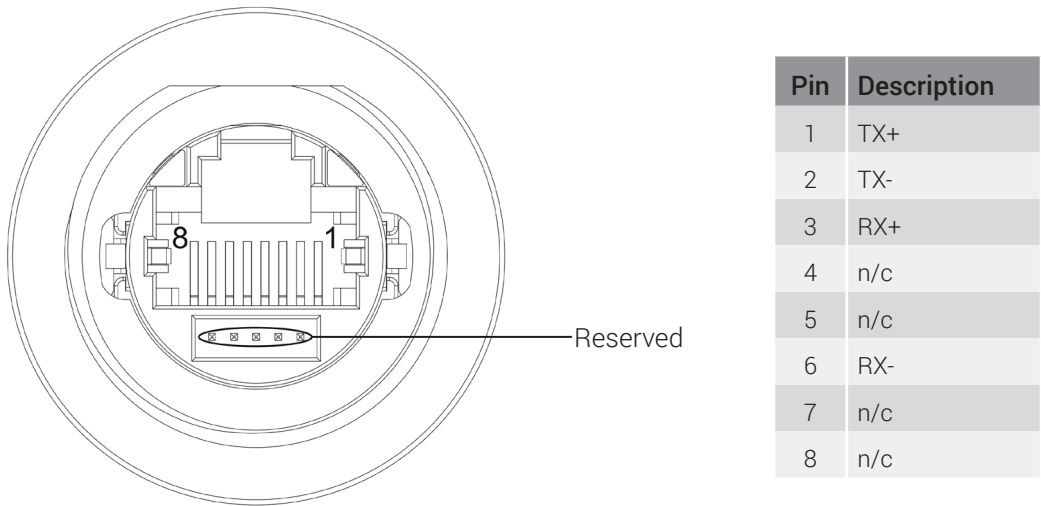

The Ethernet port have two status indicators. Please see description in figure.

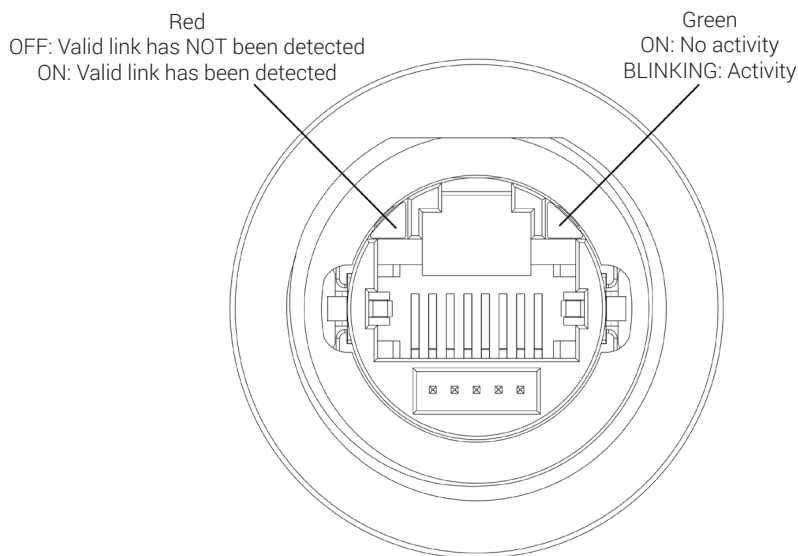

## 6 Power Supply, Grounding and Shielding

The power supply terminal block is shown in the figure below.

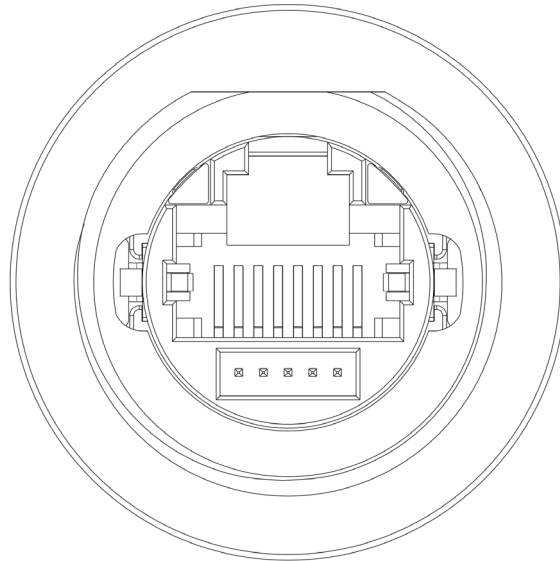

Use a shielded CAT 5 cable or higher

**Note:** *Ensure that the power supply has enough power capacity for the operation of the equipment.*

The unit must always be grounded to earth with shielded CAT 5 cable. Grounding helps limit the effects of noise due to electromagnetic interference on the control system.

The earth connection can also be made using the screws located near the connector. A label helps identify the ground connection.

All the electronic devices in the control system must be properly grounded. Grounding must be performed according to applicable regulations.

# 7 Battery

These devices are equipped with rechargeable Lithium battery, not user-replaceable.  
The following information is maintained by the battery:

- hardware real-time clock (date and time)

Charge:  
At first installation must be charged for 48 hours.  
When the battery is fully charged, it ensures a period of 3 months of date and time back-up at 25°C.

 **Battery**

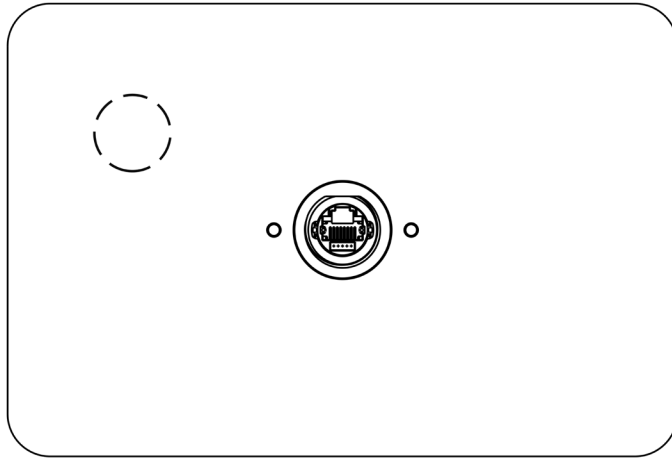

Fig. 7.1: JSmart707M

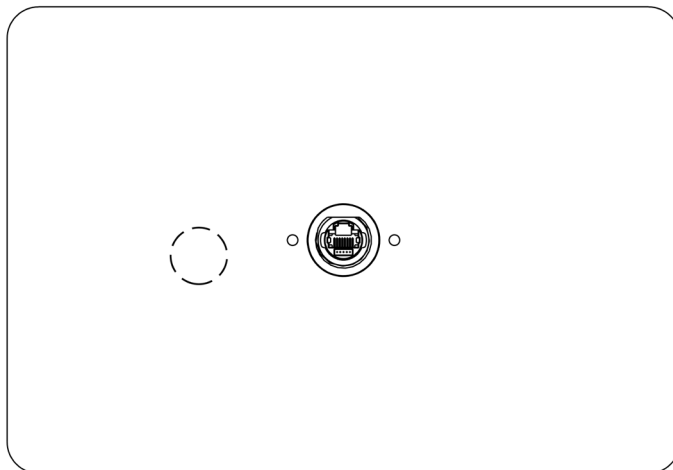

Fig. 7.2: JSmart710M

# 7 Battery

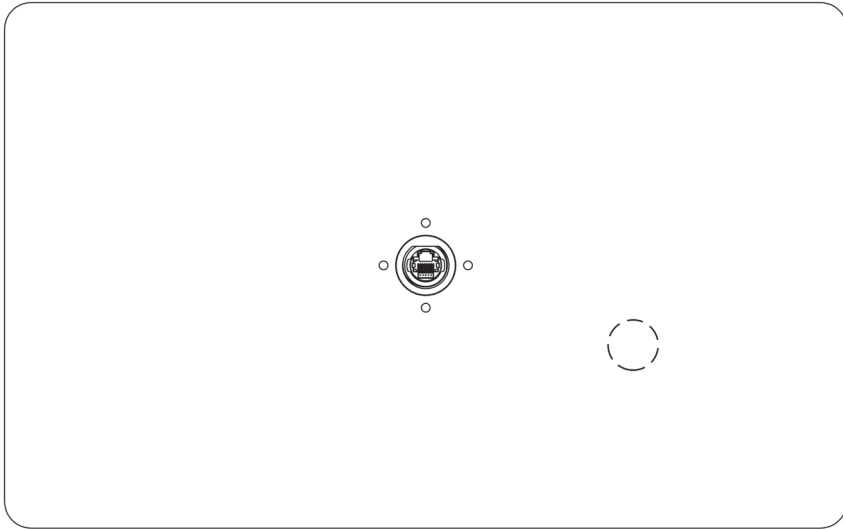

Fig. 7.3: JSmart715M

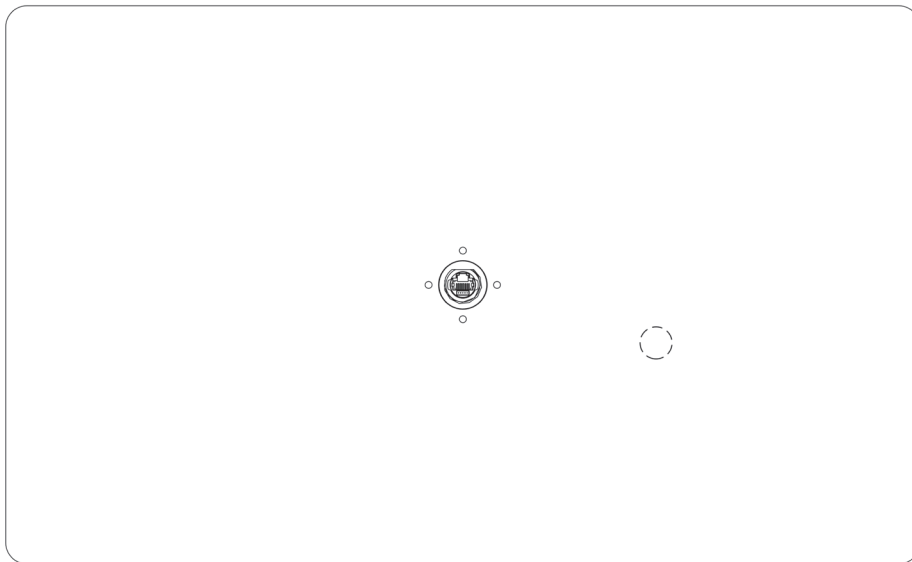





Fig. 7.4: JSmart721M

 **ATTENTION**  
Dispose of batteries according to local regulations.

 **ATTENTION**  
This device cannot be disposed of as a domestic waste but according to WEEE European Directive 2012/19/EU



## 8 Special Instruction for Use

- The equipment shall only be used in an area of not more than pollution degree 2, as defined in IEC/EN 60664-1.
- The equipment shall be installed in an enclosure that provides a degree of protection not less than IP 54 in accordance with IEC/EN 60079-15.
- Transient protection shall be provided that is set at a level not exceeding 140 % of the peak rated voltage value at the supply terminals to the equipment.
- Install the HMI device according to the accompanying installation instructions.
- Ground the HMI device according to the accompanying installation instructions.
- Only qualified personnel may install the HMI device or repair it.
- Care shall be taken not to allow layers of dust to form on the graphic panel in a way that might cause the accumulation of static charges. Keep the faceplate of the HMI device clean: the equipment must be cleaned only with a soft cloth and neutral soap product. Do not use solvents.
- This device should not be used for purposes and methods other than indicated in this document and in the documentation accompanying the product.

## 9 Getting Started

JSmart 700M HMI products delivery configuration is based on a loader. Use the services of the loader to install applications on the device such as JMobile runtime or browsers.

JMobile Studio version V4.5 or higher is required. JMobile Studio is a software tool that must be properly installed on a computer running Microsoft Windows.

There are two options to transfer a JMobile application project to a HMI device:

- |          |                                                                                                                                                                                                                                                                         |
|----------|-------------------------------------------------------------------------------------------------------------------------------------------------------------------------------------------------------------------------------------------------------------------------|
| Ethernet | Connect the HMI device to the computer with an Ethernet network. In JMobile Studio select the command Run/Download to target. You may have to ensure that the proper firewall policy has been configured in the computer to allow JMobile Studio to access the network. |
| USB      | Create an Update Package using JMobile Studio and copy it to a USB Flash drive (to transfer via USB, use the dedicated accessory cable).                                                                                                                                |

Updated product documentation is available at [www.exorint.com](http://www.exorint.com).

For the products described in this manual please check:

Systems Settings User Manual

JMobile Studio User Manual

Web Browser User Manual

# 10 Unpacking and Packing Instructions

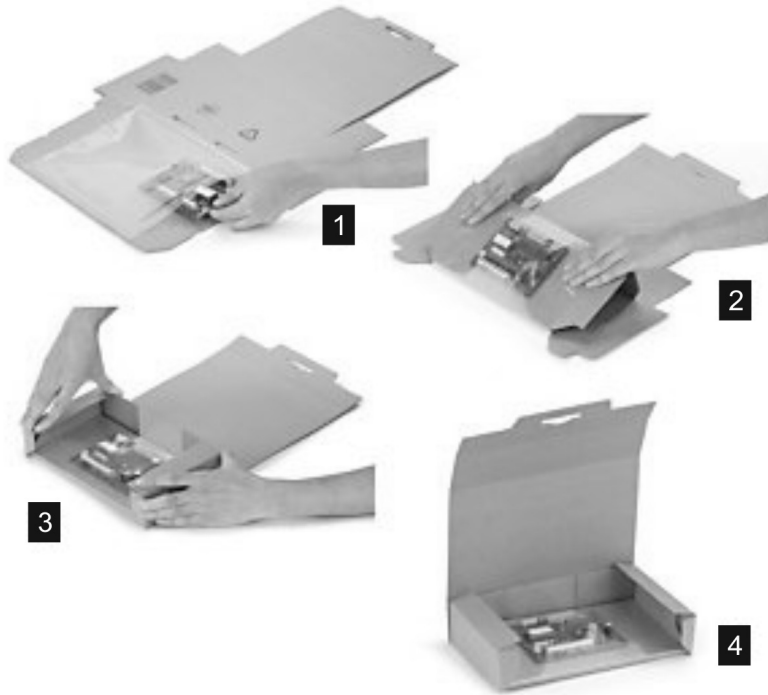

Fig. 10.1: JSmart707M, JSmart710M

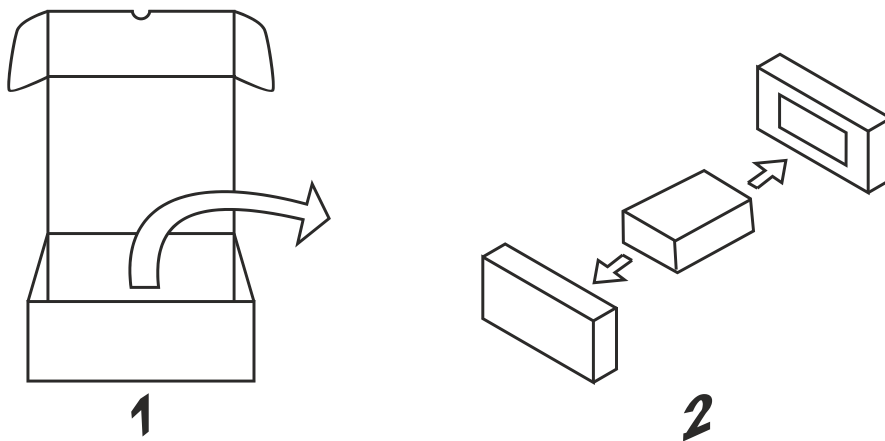

Fig. 10.2: JSmart715M, JSmart721M

To repack the unit, please follow the instructions backwards.