



## **LNX-0501 series**

**5-port Industrial Unmanaged Ethernet Switches**

**4\*10/100Tx + 1\*100Fx**



**User Manual**

## **FCC Warning**

This Equipment has been tested and found to comply with the limits for a Class-A digital device, pursuant to Part 15 of the FCC rules. These limits are designed to provide reasonable protection against harmful interference in a residential installation. This equipment generates, uses, and can radiate radio frequency energy. It may cause harmful interference to radio communications if the equipment is not installed and used in accordance with the instructions. However, there is no guarantee that interference will not occur in a particular installation. If this equipment does cause harmful interference to radio or television reception, which can be determined by turning the equipment off and on, the user is encouraged to try to correct the interference by one or more of the following measures:

- Reorient or relocate the receiving antenna.
- Increase the separation between the equipment and receiver.
- Connect the equipment into an outlet on a circuit different from that to which the receiver is connected.
- Consult the dealer or an experienced radio/TV technician for help.

## **CE Mark Warning**

This is a Class-A product. In a domestic environment this product may cause radio interference in which case the user may be required to take adequate measures.

# Content

---

<b>Introduction</b> .....	<b>1</b>
Features .....	1
Package Contents.....	2
<b>Hardware Description</b> .....	<b>3</b>
Physical Dimension.....	3
Front Panel .....	4
Top View .....	4
LED Indicators .....	5
Ports.....	6
Cabling.....	8
Wiring the Power Inputs .....	9
Wiring the Fault Alarm Contact .....	10
<b>Mounting Installation</b> .....	<b>11</b>
DIN-Rail Mounting.....	11
Wall Mounting .....	13
<b>Hardware Installation</b> .....	<b>14</b>
Installation Steps.....	14
<b>Network Application</b> .....	<b>15</b>
<b>Troubleshooting</b> .....	<b>16</b>
<b>Technical Specification</b> .....	<b>17</b>

# Introduction

---

Antaira's LNX-0501 series switches are smart 5-port Industrial Unmanaged Ethernet Switches supporting 4-Port 10/100Tx Fast Ethernet and 1-Port 100Fx of SC or ST type connector and support Multi-mode in 2Km, or Single-mode in 30Km.

The LNX-0501 series switches support 12~48VDC power inputs. This series switches offer Extend Operating Temperature model (w/-T) supports -40°C ~ 75°C. It supports IEEE 802.3/802.3u/802.3x with 10/100BTx, full or half duplex, MDI/MDI-X auto sensing to provide an economical solution for the Industrial Ethernet Network.

In addition, the Network Broadcast Storm Protection and built-in relay warning function alerts network engineers when power failures or port breaks occur.

## Features

- System Interface/Performance
  - RJ-45 ports support Auto MDI/MDI-X Function
  - Embedded 4-port 10/100Tx and 1-port 100Fx SC/ST type connector (Multi / Single mode)
  - Store-and-Forward Switching Architecture
  - Broadcast Storm Protection
  - 2K MAC Address Table
  
- Power Input
  - DC 12 ~ 48V Redundant Power
  
- Operating Temperature
  - Standard Operating Temperature model: -10°C ~ 70°C
  - Extend Operating Temperature model with -T: -40°C ~ 75°C
  
- Case/Installation
  - IP-30 Protection
  - Installation in Pollution Degree 2 Environment
  - DIN Rail and Wall Mount Design
  
- Provides EFT protection 2,000 VDC for power line
  
- Supports 6,000 VDC Ethernet ESD protection

## Package Contents

Please refer to the package contents list below.

- LNX-0501 series - 5-Port Industrial Unmanaged Switch with Fiber w/DIN Rail Bracket
- User Manual
- Removable Terminal Block
- Wall-mount Kit (2 Wall-mount Plates with Screws)

Compare the contents of the industrial switch with the checklist above. If any item is damaged or missing, please contact Antaira or Antaira's authorized channel partners for service.

# Hardware Description

---

The Industrial switch's hardware spec, port, cabling information, and wiring installation will be described.

## Physical Dimension

The LNX-0501 series - 5-Port Industrial Unmanaged Ethernet Switch with Fiber dimension: (W x D x H) is **30mm x 99mm x 142mm**

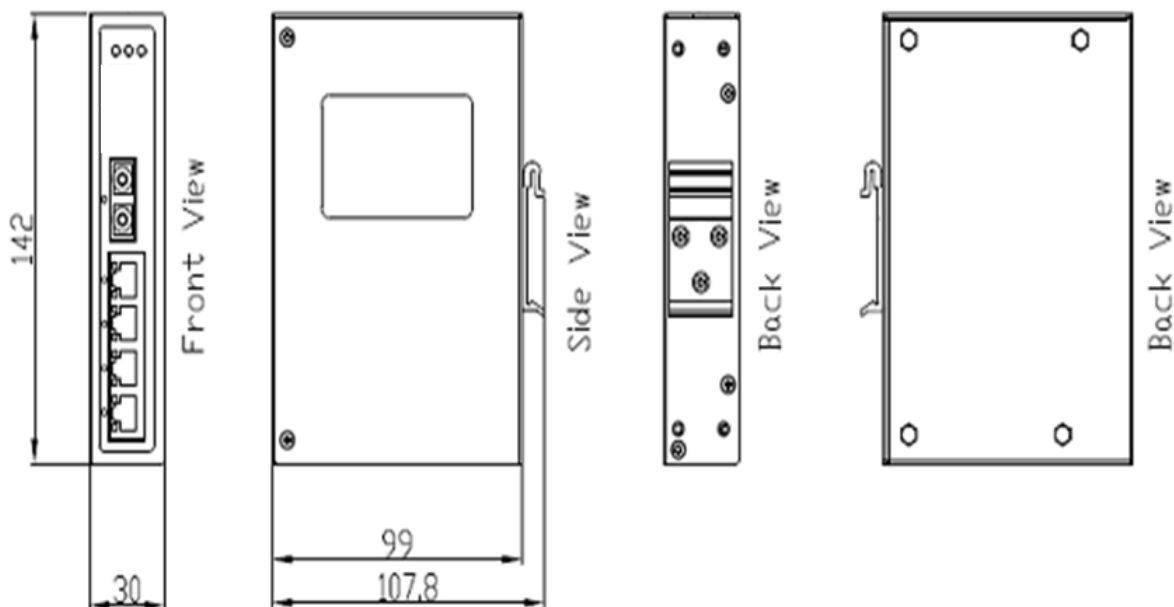

## Front Panel

The Front Panel of the Industrial Switch is shown below:



Front Panel of the Industrial Switch

## Top View

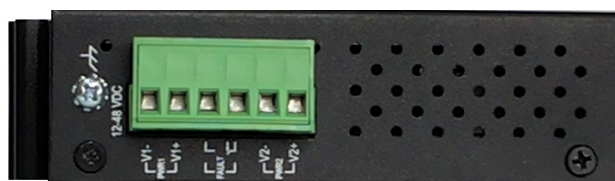

The top view of the Industrial Switch has one terminal block connector of two DC power inputs and relay circuit contact.



Top View of the Industrial Switch

## LED Indicators

The diagnostic LEDs located on the front panel of the industrial switch provide real-time information of the system and optional status. The following table provides the description of the LED status.

LED	Color	Description	
P1	Green	On	Power input 1 is active
		Off	Power input 1 is inactive
P2	Green	On	Power input 2 is active
		Off	Power input 2 is inactive
Fault	Red	On	Power input 1 or 2 has failed, port link is inactive
		Off	Power input 1 and 2 are both functional, or no power inputs/port's link is active/port alarm is disabled
LAN Port 1 ~ 4 (RJ-45)	Green 	On	Connected to network, 100Mbps
		Flashing	Networking is active
		Off	Not connected to network
	Green 	On	Connected to network, 10Mbps
		Flashing	Networking is active
		Off	Not connected to network
Fiber Port	Green	On	Connected to network, 100Mbps
		Flashing	Networking is active
		Off	Not connected to network



# Ports

## ■ RJ-45 ports

The (RJ-45) Fast Ethernet ports will auto-sense for 10Base-T or 100Base-TX connections. Auto MDI/MDIX means that the switch can connect to another switch or workstation without changing straight through or crossover cabling. Please refer to the table below for RJ-45 pin assignment.

## ■ RJ-45 Pin Assignments

Pin Number	Assignment
1	Rx+
2	Rx-
3	Tx+
6	Tx-

**Note** “+” and “-” signs represent the polarity of the wires that make up each wire pair.

All ports on this industrial switch supports automatic MDI/MDI-X operation, users can use straight-through cables (See figure below) for all network connections to PCs or servers, or to other switches or hubs. With straight-through cable, pins 1, 2, 3, and 6, at one end of the cable, are connected straight through to pins 1, 2, 3 and 6 at the other end of the cable. The table below shows the 10BASE-T/100BASE-TX MDI and MDI-X port pin outs.

Pin MDI-X	Signal Name	MDI Signal Name
1	Receive Data plus (RD+)	Transmit Data plus (TD+)
2	Receive Data minus (RD-)	Transmit Data minus (TD-)
3	Transmit Data plus (TD+)	Receive Data plus (RD+)
6	Transmit Data minus (TD-)	Receive Data minus (RD-)

The following figures show the cable schematic for both straight-through type and crossover type.

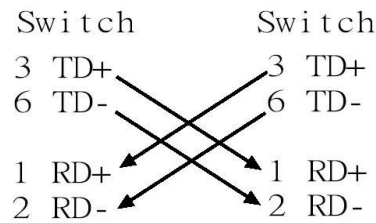
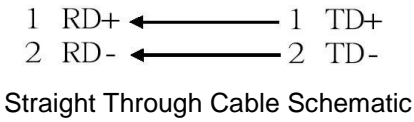
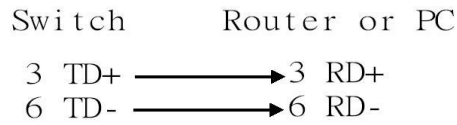

Cross Over Cable Schematic

■ **Fiber Port**

The fiber port of SC type connector can work in multi mode or single mode. When you connect the fiber port to another one, please follow the figure below to connect accordingly. Wrong connection will cause the port cannot work normally.

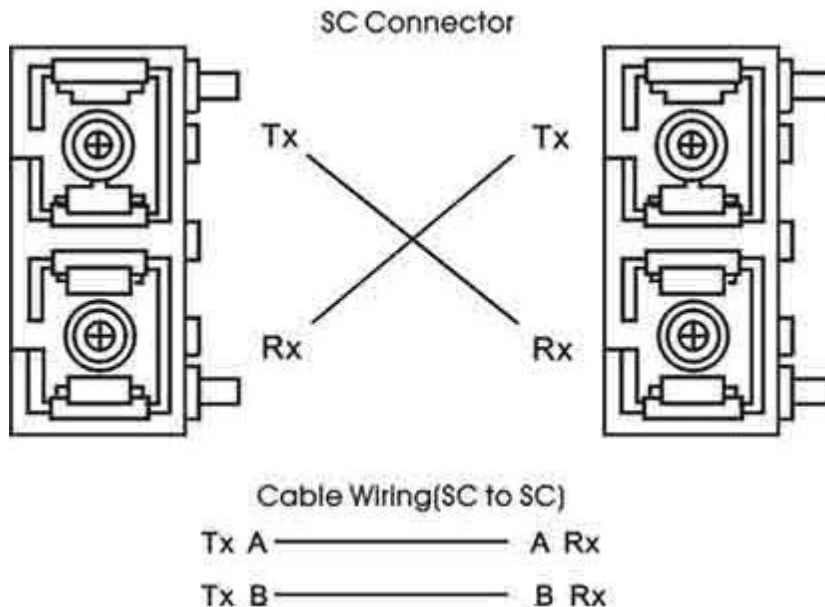

**ATTENTION**

This is a Class 1 Laser/LED product. Don't stare into the Laser/LED Beam.

## Cabling

- Twisted-pair segments can be connected with an unshielded twisted pair (UTP) or shielded twisted pair (STP) cable. The cable must comply with the IEEE 802.3u 100Base TX standard (e.g. Category 5, 5e, or 6). The cable between the equipment and the link partner (switch, hub, workstation, etc.) must be less than 100 meters (328 ft.) long.
- Fiber segment using **single-mode** connector type must use 9/125 $\mu$ m single-mode fiber cable.
- Fiber segment using **multi-mode** connector type must use 50 or 62.5/125  $\mu$ m multi-mode fiber cable.

## Wiring the Power Inputs

Please follow the steps below to insert the power wire.

Insert the positive and negative wires into the PWR1 (V1+, V1-) and PWR2 (V2+,V2-) contacts on the terminal block connector.

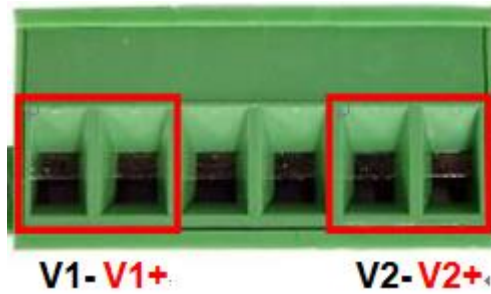

Tighten the wire-clamp screws to prevent the wires from loosening.



### **Note**

- Use Copper Conductors Only, **60/75° C**, Tighten to **5 lb in**
- The wire gauge for the terminal block should range between **18~20 AWG**.

## Wiring the Fault Alarm Contact

The fault alarm contact is in the middle of the terminal block connector as the picture shows below. By inserting the wires, it will detect the fault status including power failure or port link failure (managed industrial switch only) and form a normally open circuit. An application example for the fault alarm contact is shown as below:

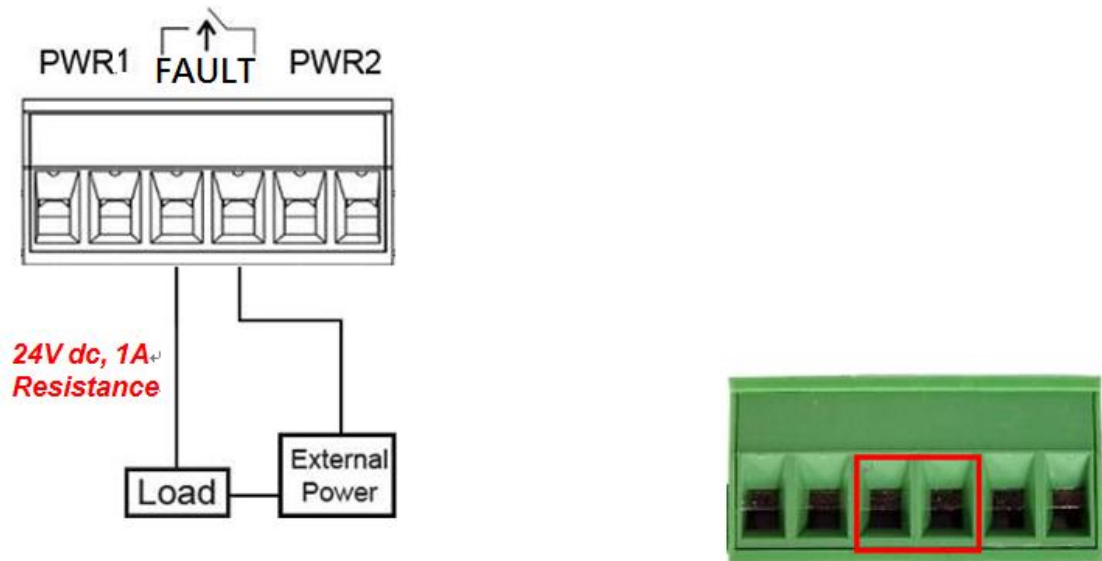

### Note

- Use Copper Conductors Only, **60/75°C**, Tighten to **5 lb in**
- The wire gauge for the terminal block should range between **12 ~ 24 AWG**.

# Mounting Installation

---

## DIN-Rail Mounting

The DIN-Rail is screwed on the industrial switch from the factory. If the DIN-Rail is not screwed on the industrial switch, please see the following pictures to screw the DIN-Rail on the switch. Follow the steps below to hang the industrial switch.

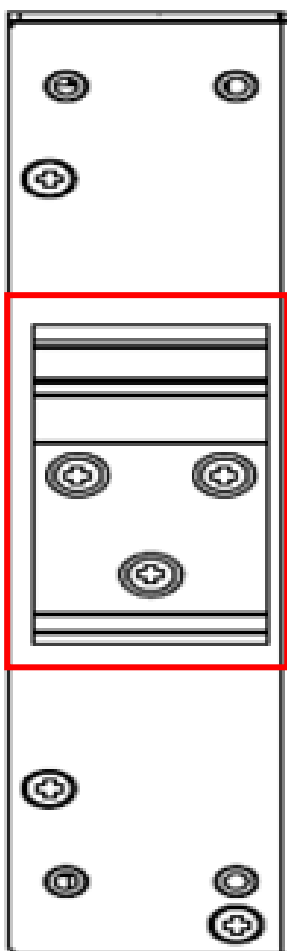

1. Use the screws to screw the DIN-Rail bracket on the rear side of the industrial switch.
2. To remove the DIN-Rail bracket, reverse the step 1.
3. After the DIN-Rail bracket is screwed on the rear side of the switch, insert the top of

DIN-Rail on to the track.



4. Then, lightly pull down the bracket on to the rail.



5. Check if the bracket is mounted tight on the rail.
6. To remove the industrial switch from the rail, reverse steps above.

## Wall Mounting

Follow the steps below to mount the industrial switch using the wall mount bracket.

1. Remove the DIN-Rail bracket from the industrial switch; loosen the screws to remove the DIN-Rail.
2. Place the wall mount bracket on the top and bottom of the industrial switch.
3. Use the screws to screw the wall mount bracket on the industrial switch.
4. Use the hook holes at the corners of the wall mount bracket to hang the industrial switch on the wall.
5. To remove the wall mount bracket, reverse steps above.

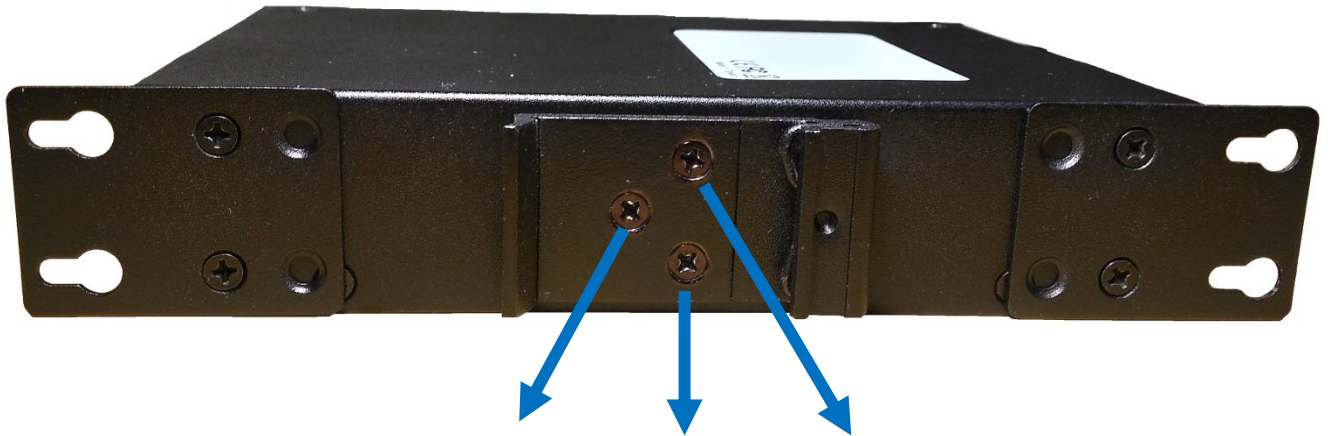

Below is the dimension of the wall mount bracket.

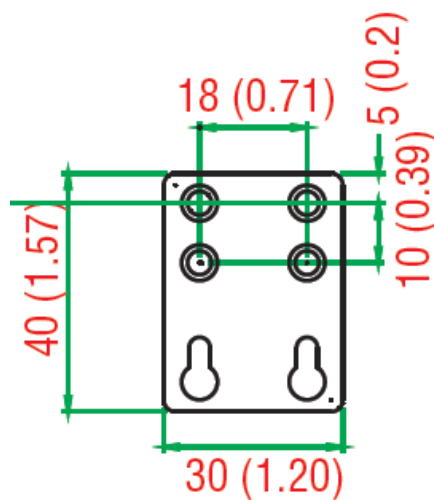



# Hardware Installation

---

This section is to explain how to install the LNX-0501 series – 5-Port Industrial Unmanaged Ethernet Switch with Fiber.

## Installation Steps

1. Unpack the Industrial switch packing.
2. Check if the DIN-Rail bracket is screwed on the Industrial switch. If the DIN-Rail is not screwed on the Industrial switch, please refer to the **DIN-Rail Mounting** section for DIN-Rail installation. If users want to wall mount the Industrial switch, then please refer to the **Wall Mounting** section for wall mount installation.
3. To hang the Industrial switch on a DIN-Rail or wall, please refer to the **Mounting Installation** section.
4. Power on the Industrial switch. Please refer to the **Wiring the Power Inputs** section for information about how to wire power. The power LED on the Industrial switch will turn on. Please refer to the **LED Indicators** section for indication of LED lights.
5. Prepare the twisted-pair, straight through Category 5/above cable for Ethernet connection.
6. Insert one side of the RJ-45 cable into the Industrial switch Ethernet port and on the other side to the network device's Ethernet port, e.g. Switch, PC or Server. The Ethernet port (RJ-45) LED on the Industrial switch will turn on when the cable is connected to the network device. Please refer to the **LED Indicators** section for LED light indication.
7. When all connections are set and the LED lights all show normal, the installation is complete.

# Network Application

---

This segment provides an example of an industrial switch application.

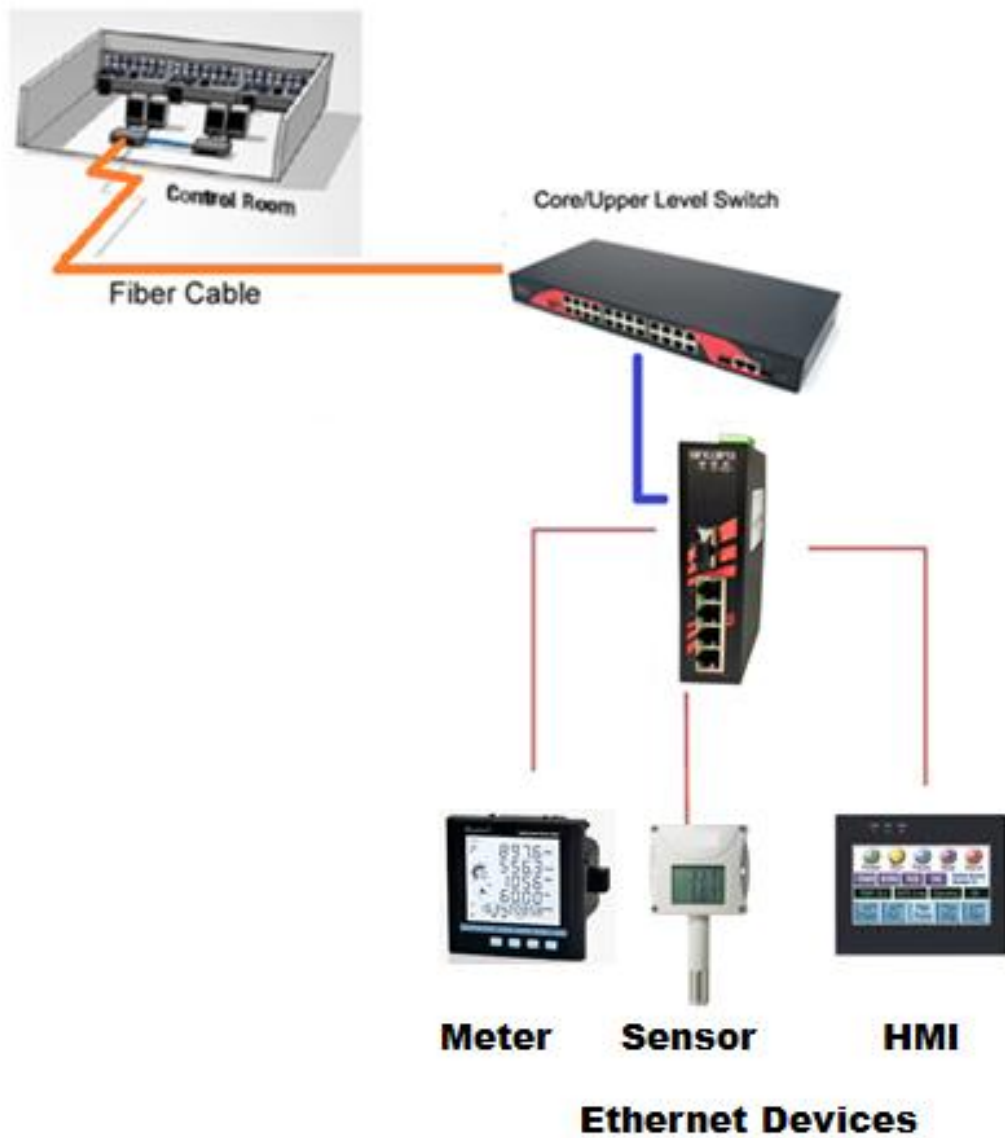

# Troubleshooting

---

- Verify the right power cord/adapter, never use power supply/adapter with non-compliant DC output voltage, or it will burn the equipment.
- Select the proper UTP/STP cable to construct the network with using the right cable. Use unshielded twisted-pair (UTP) or shield twisted-pair (STP) cable for RJ-45 connections: 100 $\Omega$  Category 5e/above cable for 10M/100Mbps. Also be sure that the length of any twisted-pair connection does not exceed 100 meters (328 feet).
- **Diagnosing LED Indicators:** To assist in identifying problems, the Switch can be easily monitored through LED indicators, which describe common problems a user may encounter and where the user can find possible solutions.
- If the power indicator LED does not turn on when the power cord is plugged in, the user may have a problem with the power cord. Check for loose power connections, power losses or surges at the power outlet. Please contact Antaira or Antaira's authorized channel partners for technical support service, if the problem still cannot be resolved.
- If the Industrial switch LED indicators are normal and the connected cables are correct but the packets still cannot transmit. Please check the system's Ethernet devices' configuration or status.

# Technical Specification

---

The LNX-0501 series - 5-Port Industrial Unmanaged Ethernet Switch with Fiber technical specifications is shown below.

<b>Standard</b>	IEEE 802.3 10Base-T Ethernet IEEE 802.3u 100Base-TX Fast Ethernet IEEE802.3x Flow Control and Back Pressure
<b>Protocol</b>	CSMA/CD
<b>Transfer Rate</b>	14,880 pps for 10Base-T Ethernet port 148,800 pps for 100Base-TX Fast Ethernet port
<b>MAC Address</b>	2K Table size
<b>RJ45 Port</b>	4*10/100BaseT(X) auto negotiation speed, Full/Half duplex mode, and auto MDI/MDI-X connection
<b>Fiber Port</b>	1*100Fx SC/ST type connector: Multi-mode (2Km) or Single-mode (30Km)
<b>Optical cable</b>	Multi mode: 50/125µm ~ 62.5/125µm Single mode: 9/125µm Wavelength: 1310nm (Multi-mode/Single-mode)
<b>LED</b>	<b>Per unit:</b> Power 1 (Green), Power 2 (Green), Fault (Red) <b>Per port:</b> Link/Activity (Green) <b>PoE:</b> Feeding Power (Green)
<b>Network Cable</b>	10Base-T: 2-pair UTP/STP Cat. 3, 4, 5, 5e cable EIA/TIA-568 100-ohm (100m) 100Base-TX: 2-pair UTP/STP Cat. 5/5e, 6 cable EIA/TIA-568 100-ohm (100m)
<b>Over Current Protection</b>	Single-Blown Fuse
<b>Power Input</b>	Redundant Power DC 12 ~ 48 V with Connective 1*6-Pin Removable Terminal Block

<b>Max Power Consumption</b>	7.5 Watts
<b>Installation</b>	DIN Rail Mounting, Wall Mounting
<b>Operating Temp.</b>	Standard Operating Temperature: -10°C to 70°C Extend Operating Temperature: -40°C to 75°C
<b>Operating Humidity</b>	5% to 95% (Non-Condensing)
<b>Storage Temperature</b>	-40°C to 85°C
<b>Case Dimension</b>	IP-30, 30mm (W) x 99mm (D) x 142mm (H)
<b>EMI</b>	FCC Class A CE EN61000-4-2/3/4/5/6/8 CE EN61000-6-2 CE EN61000-6-4
<b>Safety</b>	UL 508 ULClass 1 Division 2
<b>Stability testing</b>	IEC60068-2-32 (Free fall) IEC60068-2-27 (Shock) IEC60068-2-6 (Vibration)