



LMX-0800G Series

**8-Port Industrial Gigabit Managed Ethernet Switch,
with 8*10/100/1000Tx Ethernet Ports**



Version 1.2

Hardware Manual



© Copyright 2018 Antaira Technologies, LLC

All Rights Reserved

This document contains information, which is protected by copyright. Reproduction, adaptation or translation without prior permission is prohibited, except as allowed under the copyright laws.

Trademark Information

Antaira is a registered trademark of Antaira Technologies, LLC, Microsoft Windows and the Windows logo are the trademarks of Microsoft Corp. NetWare is the registered trademark of Novell Inc. WMM and WPA are the registered trademarks of Wi-Fi Alliance. All other brand and product names are trademarks or registered trademarks of their respective owners.

Notice: Copyrights © 2018 by Antaira Technologies, LLC. All rights reserved. Reproduction, adaptation, or translation without prior permission of Antaira Technologies, LLC is prohibited, except as allowed under the copyright laws.

Disclaimer

Antaira Technologies, LLC provides this manual without warranty of any kind, expressed or implied, including but not limited to the implied warranties of merchantability and fitness for a particular purpose. Antaira Technologies, LLC may make improvements and/or changes to the product and/or specifications of the product described in this manual, without prior notice. Antaira Technologies, LLC will not be liable for any technical inaccuracies or typographical errors found in this guide. Changes are periodically made to the information contained herein and will be incorporated into later versions of the manual. The information contained is subject to change without prior notice.

FCC Warning

This equipment has been tested and found to comply with the limits for a Class-A digital device, pursuant to Part 15 of the FCC rules. These limits are designed to provide reasonable protection against harmful interference in a residential installation. This equipment generates, uses, and can radiate radio frequency energy. It may cause harmful interference to radio communications if the equipment is not installed and used in accordance with the instructions. However, there is no guarantee that interference will not occur in a particular installation. If this equipment does cause harmful interference to radio or television reception, which can be determined by turning the equipment off and on, the user is encouraged to try to correct the interference by one or more of the following measures:

- Reorient or relocate the receiving antenna.
- Increase the separation between the equipment and receiver.
- Connect the equipment into an outlet on a circuit different from that to which the receiver is connected.
- Consult the dealer or an experienced radio/TV technician for help.

Caution: Any changes or modifications not expressly approved by the grantee of this device could void the user's authority to operate the equipment.

CE Mark Warning

This is a Class-A product. In a domestic environment this product may cause radio interference in which case the user may be required to take adequate measures.

Industrial Ethernet Switches

Industrial Grade Gigabit Managed Ethernet Switches

Hardware Manual

Version 1.2 (March 2018)

This manual supports the following models:

- LMX-0800G
- LMX-0800G-T

This document is the current official release manual. Please check our website (www.antaira.com) for any updated manual or contact us by e-mail (support@antaira.com).

Table of Contents

1. Introduction	1
1.1 Product Overview	1
1.2 Product Software Features	1
1.3 Product Hardware Features	2
1.4 Package Contents	3
1.5 Safety Precaution	3
2. Hardware Description	4
2.1 Physical Dimensions	4
2.2 Front Panel	5
2.3 Top View	5
2.4 LED Indicators	7
2.5 Reset Button	7
2.6 Ethernet Ports	8
2.7 Cabling	9
2.8 Wiring the Power Inputs	10
2.9 Wiring the Fault Alarm Contact	10
2.10 Grounding Note	11
3. Mounting Installation.....	12
3.1 DIN-Rail Mounting	12
3.2 Wall Mounting	13
4. Hardware Installation	14
4.1 Installation Steps	14
4.2 Maintenance and Service	14
5. Technical Specifications	16

1. Introduction

All Antaira industrial managed switches come with a pre-installed “user-friendly” web console interface, which allows users to easily configure and manage the units, whether one is using a serial console and command line interface (CLI) commands like Telnet, SSH, HTTP (Web GUI) or simple network management protocols (SNMP).

1.1 Product Overview

Antaira Technologies’ LMX-0800G series is an 8-port industrial gigabit managed Ethernet switch that is embedded with eight gigabit Ethernet ports. It supports Jumbo Frame up to 9.6K for huge Ethernet data packet transmissions. It is a fully manageable Layer 2 Ethernet switch that is pre-loaded with a user-friendly web management console design. It supports the ring network redundancy function using the market’s open standard ITU-T G.8032 ERPS (Ethernet Ring Protection Switch) protocol that has a <50ms network recovery time. The advanced network filtering and security functions, such as, IGMP, VLAN, QoS, SNMP, RMON, Modbus TCP, and 802.1X/HTTPS/SSH/SSL increase determinism and improve network management for remote SCADA systems or control networks.

The LMX-0800G series is a compact, IP30 rated, and DIN-rail or wall mountable. There are also two different models for varying operating temperatures, for either a standard temperature range (STD: -10°C to 70°C) or an extended temperature range (EOT: -40°C to 75°C). It also provides high EFT and ESD protection for industrial networking applications, such as, power/utility, water wastewater, oil/gas/mining, factory automation, security surveillance, ITS and any other outdoor or harsh environment.

1.2 Product Software Features

- Network Redundancy
 - STP, RSTP, MSTP, ITU-T G.8032 Ethernet Ring Protection Switch (ERPS) for network redundancy
- Network Management
 - Web UI based management, SNMP v1/v2/v3, Serial Console
 - Qos, traffic classification QoS, Cos, bandwidth control for Ingress and Egress, broadcast storm control, Diffserv
 - IEEE802.1q VLAN tagging, port-based VLAN support

- IGMP snooping v1/v2, IGMP filtering / throttling, IGMP query up to 256 group
- Supports IPv4/IPv6, RMON, MIB II, port mirroring, event syslog, DNS, NTP/SNTP, HTTPS, SSH/SSL, TFTP
- MODBUS TCP for SCADA system integration
- Port Configuration
 - Status, statistics, mirroring, rate limiting, event syslog
- Event Handling
 - Event notification by Email: Cold/Warm Start, Power Failure, Authentication, SNMP trap and Fault Alarm Relay Output
- Software Upgrade via TFTP and HTTP
- Configuration Backup – USB Port

1.3 Product Hardware Features

- System Interface and Performance
 - All RJ-45 ports support Auto MDI/MDI-X Function
 - Embedded 8*10/100/1000Tx Gigabit RJ45 Ports
 - Store-and-forward switching architecture
 - 8K MAC address table
 - Power line EFT protection: 2,000VDC; Ethernet ESD protection: 6,000VDC
- Power Input
 - DC 12~48V redundant with a 6-pin removal terminal block
 - One user programmable alarm relay contact
 - The power input specification is complied with the requirements of SELV (Safety Extra Low Voltage), and the power supply should be complied with UL 61010-1 & UL 61010-2-201
- Operating Temperature
 - Standard operating temperature models: -10°C to 70°C
 - Extended operating temperature models: -40°C to 75°C
- Case/Installation
 - IP-30 protection metal housing
 - DIN-Rail and wall mount design
 - Installation in a Pollution Degree 2 industrial environment

1.4 Package Contents

- 1– LMX-0800G series: 8-port industrial gigabit managed Ethernet switch, with 8*10/100/1000Tx ports
- 1-Product CD
- DIN Rail Kit & 2-Wall mounting brackets and screws
- 1-RJ45 to DB9 Serial Console cable
- 1-DC cable –18 AWG & DC jack 5.5x2.1mm

1.5 Safety Precaution

Attention: If the DC voltage is supplied by an external circuit, please use a protection device on the power supply input. The industrial Ethernet switch's hardware specs, ports, cabling information, and wiring installation will be described within this user manual.

Warning Labels

The caution label means that you should check the certain information on user manual when working with the device. (Shown in Figure 1.1)



Figure 1.1 - Caution Label

This warning label is on the device, and means that the surface of the device is hot. (Shown in Figure 1.2)



Figure 1.2 - Hot Surface Warning Label

2. Hardware Description

2.1 Physical Dimensions

Figure 2.1, below, shows the physical dimensions of Antaira's LMX-0800G series: 8-port industrial gigabit managed Ethernet switches with 8*10/100/1000Tx RJ45 Ethernet ports.

(W x D x H) is **54mm x 99mm x 142mm**

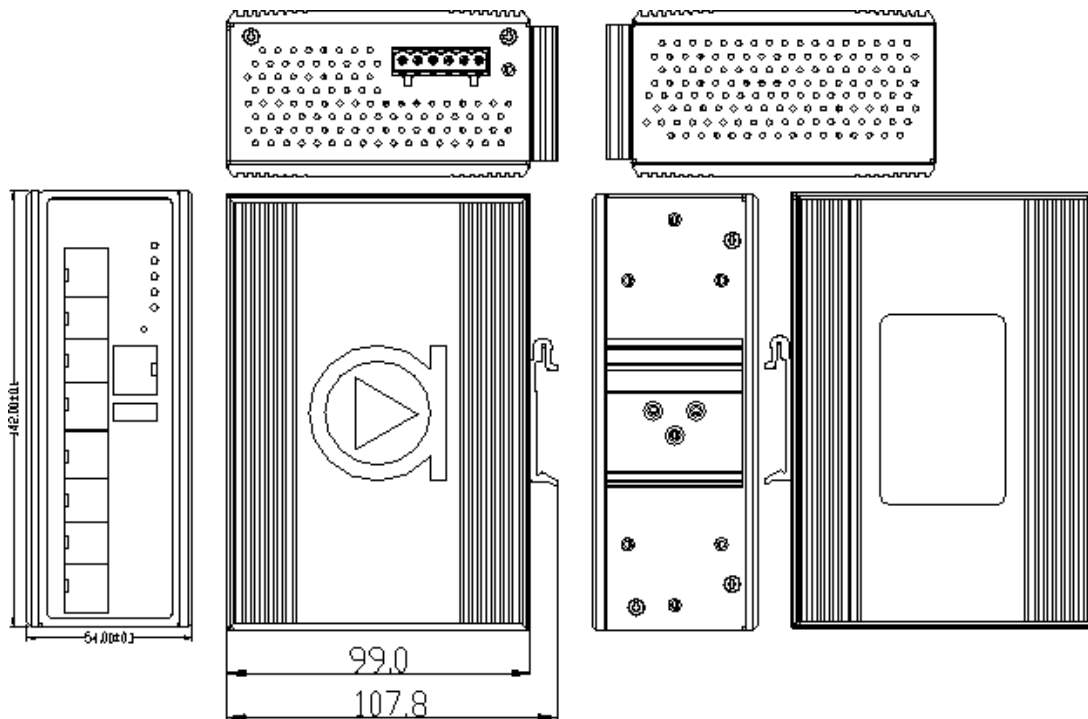

Figure 2.1

LMX-0800G Series Physical Dimensions

2.2 Front Panel

The front panel of the LMX-0800G series industrial gigabit managed Ethernet switch is shown below in *Figure 2.2*.

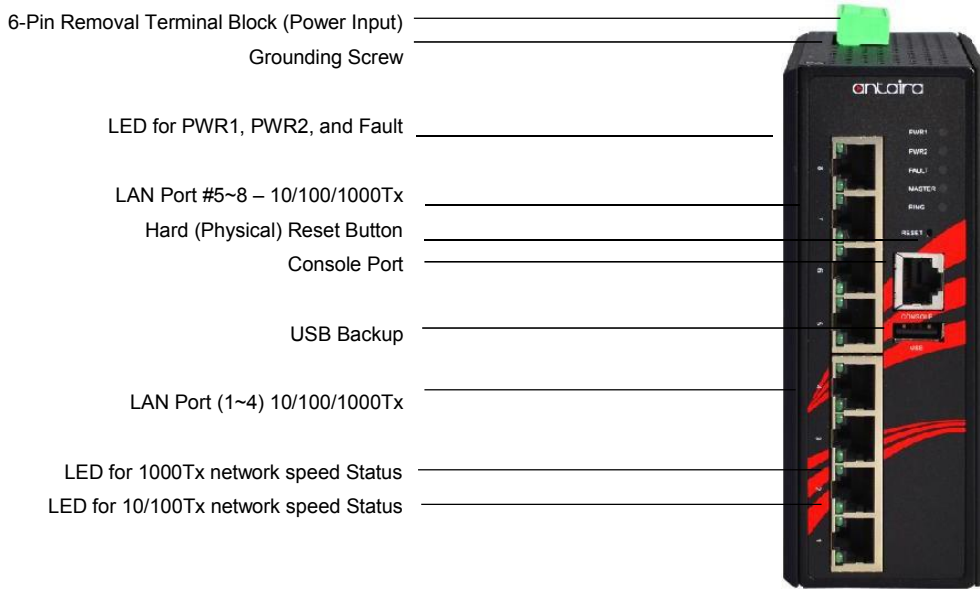

Figure 2.2

The Front Panel of LMX-0800G Series

2.3 Top View

Figure 2.3, below, shows the top panel of the LMX-0800G series switch that is equipped with one 6-pin removal terminal block connector for dual DC power inputs 12~48VDC.

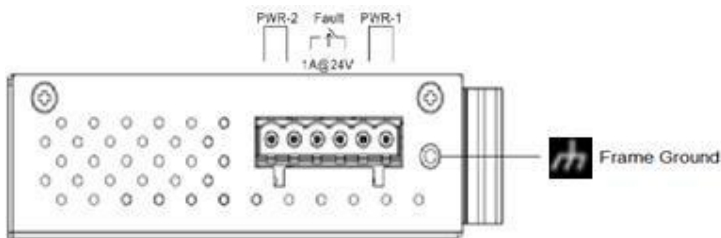

Figure 2.3

Top Panel View of LMX-0800G Series

2.4 LED Indicators

There are LED light indicators located on the front panel of the industrial Ethernet switch that display the power status and network status. Each LED indicator has a different color and has its own specific meaning, see below in *Table 2.1*.



LED	Color	Description	
P1	Green	On	Power input 1 is active
		Off	Power input 1 is inactive
P2	Green	On	Power input 2 is active
		Off	Power input 2 is inactive
Fault	Green/ Red	Green	Power input 1 or 2 is inactive
		Red	An applied alarm (such as port disconnect) has been triggered
		Off	Power input 1 and 2 are both functional, and no active/port alarm is detecting errors
Owner	Green	On	ERPS Owner Mode (Ring Master) is ready
		Off	ERPS Owner Mode is not active
Ring	Green	On	Ring Network is active
		Off	Ring Network is not active
LAN Port 1 ~ 8 (Left LED)		On	Connected to network, 1000Mbps
		Flashing	Networking is active
		Off	Not connected to network
LAN Port 1~ 8 (Right LED)		On	Networking is active, 100/10Mbps
		Flashing	Networking is active
		Off	Not connected to network

Table 2.1 - LED Indicators for LMX-0800G Series



Caution: "P1" is the abbreviation for "Power ", "P2" is for "Power 2", "LNK" is for "Link", and "ACT" is for "Activity".

2.5 Reset Button

There is a Reset button located on the front panel of the industrial Ethernet switch that helps users to reboot, restore default, or save running configurations by pressing the button for different seconds. Please refer to *Table 2.2* for the timing and function.

Seconds	Function
1	Save running configuration to USB
4-6	Reboot the switch
7 or more	Restore factory default

Table 2.2 – Reset Button Functions

2.6 Ethernet Ports

▪ RJ-45 Ports

RJ-45 Ports (Auto MDI/MDIX): The RJ-45 ports are auto-sensing for 10Base-T, 100Base-TX, or 1000Base-T connections. Auto MDI/MDIX means that the switch can connect to another switch or workstation without changing the straight-through or crossover cabling. See the figures below for straight-through and crossover cabling schematics.

▪ RJ-45 Pin Assignments

Pin Number	Assignment
1	Rx+
2	Rx-
3	Tx+
6	Tx-

Table 2.3 - RJ45 Pin Assignments

Note: The “+” and “-” signs represent the polarity of the wires that make up each wire pair.

All ports on this industrial Ethernet switch support automatic MDI/MDI-X operations. Users can use straight-through cables (see figure below) for all network connections to PCs, servers, and other switches or hubs. With straight-through cabling, pins 1, 2, 3, and 6 are at one end of the cable and are connected straight through to pins 1, 2, 3 and 6 at the other end of the cable. The table below (Table 2.3) shows the 10BASE-T/100BASE-TX/1000BASE-T MDI and MDI-X port pin outs.

Pin MDI-X	Signal Name	MDI Signal Name
1	Receive Data plus (RD+)	Transmit Data plus (TD+)
2	Receive Data minus (RD-)	Transmit Data minus (TD-)
3	Transmit Data plus (TD+)	Receive Data plus (RD+)
6	Transmit Data minus (TD-)	Receive Data minus (RD-)

Table 2.4 - Ethernet Signal Pin

The following figures show the cabling schematics for straight-through and crossover.

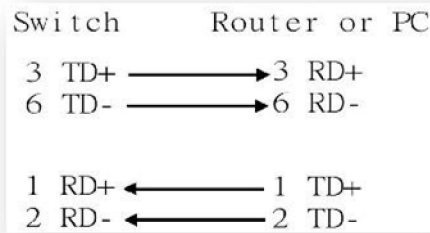

Figure 2.4
Straight-Through Cable Schematic

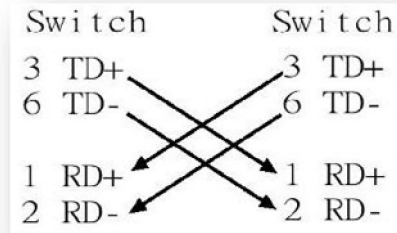

Figure 2.5
Crossover Cable Schematic

7

2.7 Cabling

Use the four twisted-pair, category 5e, or the above cabling for the RJ-45 port connections. The cable between the switch and the link partner (switch, hub, workstation, etc.) must be less than 100 meters (328 ft.) in length.

2.8 Wiring the Power Inputs



Caution: Please follow the steps below when inserting the power wire.

1. Insert the positive and negative wires into the PWR1 (V1+, V1-) and PWR2 (V2+, V2-) contacts on the terminal block connector as shown below in *Figure 2.6*.

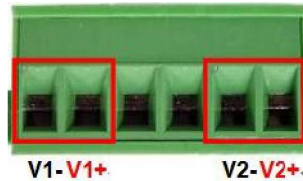

Figure 2.6 - Power Terminal Block

2. Tighten the wire-clamp screws to prevent the wires from loosening, as shown below in *Figure 2.7*.

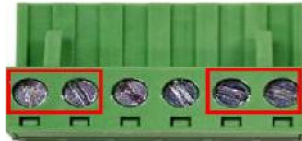

Figure 2.7 - Power Terminal Block

Note:

- Only use copper conductors, 60/75° C, tighten to 5lbs.
- The wire gauge for the terminal block should range between 18~20 AWG.

2.9 Wiring the Fault Alarm Contact

The fault alarm contact is in the middle of the terminal block connector as the picture shows below in *Figure 2.14*. By inserting the wires, it will detect the fault status including power failure or port link failure (managed industrial switch only) and form a normally open circuit. An application example for the fault alarm contact is shown below in *Figure 2.13*.

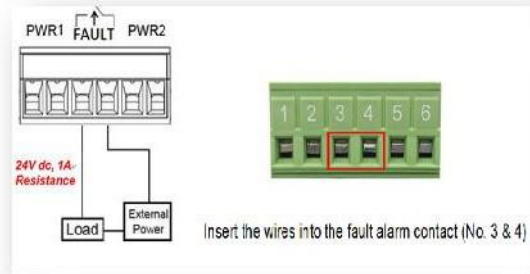

Figure 2.13 –

Wiring the Fault Alarm Contact



Caution:

- The wire gauge for the terminal block should range between **12 ~ 24AWG**
- If only using one power source, jumper Pin 1 to Pin 5 and Pin 2 to Pin 6 to eliminate power fault alarm.

2.10 Grounding Note

Grounding and wire routing help limit the effects of noise due to electromagnetic interference (EMI). Run the ground connection from the ground screw to the grounding surface prior to connecting devices. The grounding screw symbol is shown below in *Figure 2.15*.



Figure 2.15 - Grounding screw



Caution: Using a shielded cable achieves better electromagnetic compatibility.

3. Mounting Installation

3.1 DIN-Rail Mounting

The DIN-Rail is pre-installed on the industrial Ethernet switch from the factory. If the DIN-Rail is not on the industrial Ethernet switch, please see Figure 3.1 to learn how to install the DIN-Rail on the switch.

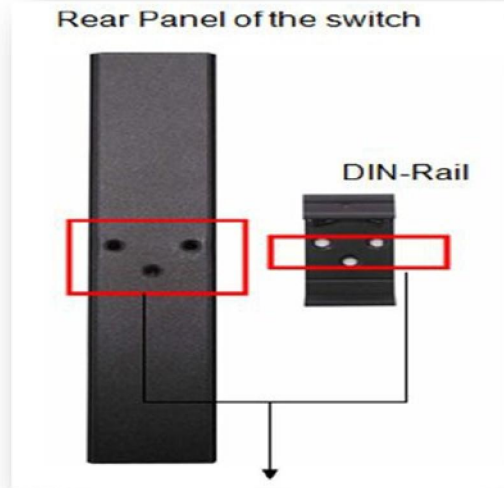

Figure 3.1

The Rear Side of the Switch and DIN-Rail Bracket

Follow the steps below to learn how to hang the industrial Ethernet switch.

1. Use the screws to install the DIN-Rail bracket on the rear side of the industrial Ethernet switch.



Caution: The torque for tightening the screws on the device is 3.5 in-lbs.

2. To remove the DIN-Rail bracket, do the opposite from step 1.
3. After the DIN-Rail bracket is installed on the rear side of the switch, insert the top of the DIN-Rail on to the track as shown below in *Figure 3.2*.
4. Lightly pull down the bracket on to the rail as shown below in *Figure 3.3*.
5. Check if the bracket is mounted tightly on the rail.
6. To remove the industrial Ethernet switch from the rail, do the opposite from the above steps.

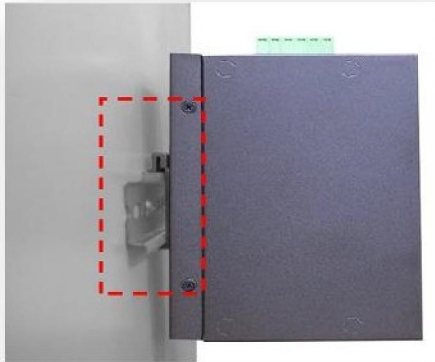

Figure 3.2 - Insert the Switch on the DIN-Rail



Figure 3.3 - Stable the Switch on DIN-Rail

3.2 Wall Mounting

Follow the steps below to mount the industrial Ethernet switch using the wall mounting bracket as shown below in *Figure 3.4*.



Caution: “Wall” means industrial control panel wall

1. Remove the DIN-Rail bracket from the industrial Ethernet switch by loosening the screws.
2. Place the wall mounting brackets on the top and bottom of the industrial Ethernet switch.
3. Use the screws to screw the wall mounting bracket on the industrial Ethernet switch.



Caution: The torque for tightening the screws on the device is 3.5 in-lbs.

4. Use the hook holes at the corners of the wall mounting bracket to hang the industrial Ethernet switch on the wall.
5. To remove the wall mount bracket, do the opposite from the steps above.



Figure 3.4

Remove DIN-Rail Bracket from the Switch

Below, in *Figure 3.5* are the dimensions of the wall mounting bracket.

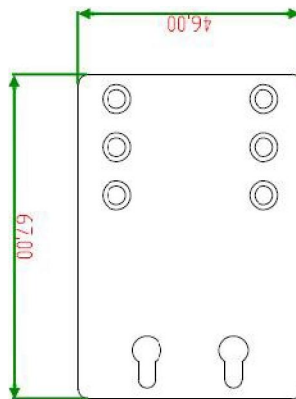

Figure 3.5

Wall Mounting Bracket Dimensions

4. Hardware Installation

4.1 Installation Steps

This section will explain how to install Antaira's LMX-0800G series: 8-port industrial gigabit managed Ethernet switches with 8*10/100/1000Tx ports.



Caution: This device is intended for use indoor and at altitudes up to 2000 meters.



Caution: The device is intended to be installed in an industrial control enclosure and panel.

Installation Steps

1. Unpack the industrial Ethernet switch from the original packing box.
2. Check if the DIN-Rail bracket is screwed on the industrial Ethernet switch.
 - If the DIN-Rail is not screwed on the industrial Ethernet switch, please refer to the **DIN-Rail Mounting** section for DIN-Rail installation.
 - If you want to wall mount the industrial Ethernet switch, please refer to the **Wall Mounting** section for wall mounting installation.
3. To hang the industrial Ethernet switch on a DIN-Rail or wall, please refer to the **Mounting Installation** section.
4. Power on the industrial Ethernet switch and then the power LED light will turn on.
 - If you need help on how to wire power, please refer to the **Wiring the Power Inputs** section.
 - Please refer to the **LED Indicators** section for LED light indication.
5. Prepare the twisted-pair, straight-through category 5 cable for Ethernet connection.
6. Insert one side of the RJ-45 cable into switch's Ethernet port and on the other side into the networking device's Ethernet port, e.g. switch PC or server. The Ethernet port's (RJ-45) LED on the industrial Ethernet switch will turn on when the cable is connected to the networking device.
 - Please refer to the **LED Indicators** section for LED light indication.
7. When all connections are set and the LED lights all show normal, the installation is complete.

4.2 Maintenance and Service

- If the device requires servicing of any kind, the user is required to disconnect and remove it from its mounting. The initial installation should be done in a way that makes this as convenient as possible.
- Voltage/Power lines should be properly insulated as well as other cables. Be careful when handling them so as to not trip over.
- Do not under any circumstance insert foreign objects of any kind into the heat dissipation holes

located in the different faces of the device. This may not only harm the internal layout, but might cause harm to user as well.

- Do not under any circumstance open the device for any reason. Please contact your dealer for any repair needed or follow the instructions within the manual.
- Clean the device with dry soft cloth.

5. Technical Specifications

Table 5.1 has the technical specifications for Antaira's LMX-0800G series: 8-port industrial gigabit managed Ethernet switches with 8*10/100/1000Tx ports.

Standards	IEEE 802.3	10Base-T 10Mbit/s Ethernet
	IEEE 802.3u	100Base-Tx, 100Base-Fx, Fast Ethernet
	IEEE 802.3ab	1000Base-Tx Gigabit Ethernet
	IEEE 802.3x	Flow Control for Full Duplex
	IEEE 802.3ad	Port Trunking with LACP
	IEEE 802.1d	STP (Spanning Tree Protocol)
	IEEE 802.1w	RSTP (Rapid Spanning Tree Protocol)
	IEEE 802.1s	MTP (Multiple Spanning Tree Protocol)
	ITU-TG.8032 / Y.1344	ERPS (Ethernet Ring Protection Switch)
	IEEE 802.1q	Virtual LANs (VLAN)
	IEEE 802.1x	Port based Network Control, Authentication
	IEEE 802.1ad	Stacked VLAN, Q-in-Q
	IEEE 802.1p	QoS/CoS Protocol for Traffic Prioritization
Switch	Protocol	IGMPv1/v2, SNMPv1/v2c/v3, TFTP, SNMP, SMTP, RMON, HTTP, HTTPS, Telnet, Syslog, DHCP Option 66/67/82, SSH/SSL, Modbus/TCP, LLDP, IPv4/IPv6
	Data Process	Store and Forward
	Transfer Rate	14,880 pps for 10Base-Tx Ethernet port 148,800 pps for 100Base-TX Fast Ethernet port 1,488,000pps for 1000Base-TxGigabit Ethernet port
	Packet Buffer	4 Mbits
	MAC Table	8K
	Jumbo Frame	9.6k
	Flow Control	IEEE 802.3x for full duplex mode, back pressure for half duplex mode
	VLAN Groups	1 ~ 4094
	IGMP Groups	Up to 256
Port Interface	Ethernet (RJ45) Port	8*10/100/1000BaseTx auto negotiation speed, Full/Half duplex mode, and auto MDI/MDI-X connection
	Serial Console Port	1*RS232 in RJ45 connector with console cable, 115.2Kbps, 8,N,1
	Configuration Backup Port	1*USB 2.0
Protection	Overload Current	Present
	Power Reverse polarity	Present
	CPU Watch Dog	Present
	Network Cable	10Base-T: 2-pair UTP/STP Cat. 3, 4, 5 cable; 100Base-TX: 2-

		pair UTP/STP Cat. 5 cable. EIA/TIA-568 100-ohm (100m) 1000BaseTX: UTP/STP Cat.5/5E cable; EIA/TIA-568 100-ohm (100m)
Mechanical Characteristics	LED Indicator	Power Unit: P1 (Green), P2 (Green), fault (Red) Ethernet port: Link/active (Green), 1000Mbps
	Housing	Metal IP30 protection
	Dimension	54 x 142 x 99 mm
	Weight	Unit Weight: 2.1 lbs. Shipping Weight: 2.9 lbs
	Mounting	DIN-Rail Mounting, wall-mounting (optional)
Power Requirement	Input Voltage	12~48VDC Redundant Input
	Power Connection	1 removable 6-contact terminal block
	Power Consumption	15 Watts
Environmental Limits	Operating Temperature	STD: -10° to 70° C (14° to 158° F); EOT: -40° to 75° C (-40° to 167° F)
	Storage Temperature	-40°C ~ 85°C (-40°F ~ 185°F)
	Ambient Relative Humidity	5 to 95%, (non-condensing)
Regulatory Approvals	EMI	FCC Class A
	EMS	IEC6100-4-2/3/4/5/6/8; IEC6100-6-2; IEC6100-6-4
	Stability Testing	IEC60068-2-32 (Free fall) IEC60068-2-27 (Shock) IEC60068-2-6 (Vibration)
	Safety	UL 61010-1, UL 61010-2-201

Table 5.1 - LMX-0800G Series Technical Specifications

Antaira Customer Service and Support

(Antaira US Headquarter) + 844-268-2472

(Antaira Europe Office) + 48-22-862-88-81

(Antaira Asia Office) + 886-2-2218-9733

Please report any problems to Antaira:www.antaira.com / support@antaira.comwww.antaira.eu / info@antaira.euwww.antaira.com.tw / info@antaira.com.tw

Any changes to this material will be announced on the Antaira website.