



INJ-C201G-bt-T

Industrial Gigabit PoE++ Injector, with 1*10/100/1000Base-T(X)
(90W/Port) and 1*10/100/1000Base-T(X); EOT: -40°C ~ 75°C



Hardware Manual

Version 1.0
(November 2021)



© Copyright 2021 Antaira Technologies, LLC

All rights reserved

This document contains information, which is protected by copyright. Reproduction, adaptation, or translation without prior permission is prohibited, except as allowed under the copyright laws.

Trademark Information

Antaira is a registered trademark of Antaira Technologies, LLC, Microsoft Windows, and the Windows logo are the trademarks of Microsoft Corp. NetWare is the registered trademark of Novell Inc. WMM and WPA are the registered trademarks of Wi-Fi Alliance. All other brand and product names are trademarks or registered trademarks of their respective owners.

Notice: Copyrights © 2021 by Antaira Technologies, LLC. All rights reserved. Reproduction, adaptation, or translation without prior permission of Antaira Technologies, LLC is prohibited, except as allowed under the copyright laws.

Disclaimer

Antaira Technologies, LLC provides this manual without warranty of any kind, expressed or implied, including but not limited to the implied warranties of merchantability and fitness for a particular purpose. Antaira Technologies, LLC may make improvements and/or changes to the product and/or specifications of the product described in this manual, without prior notice. Antaira Technologies, LLC will not be liable for any technical inaccuracies or typographical errors found in this guide. Changes are periodically made to the information contained herein and will be incorporated into later versions of the manual. The information contained is subject to change without prior notice.

FCC Warning

This equipment has been tested and found to comply with the limits for a Class-A digital device, according to Part 15 of the FCC rules. These limits are designed to provide reasonable protection against harmful interference in a residential installation. This equipment generates, uses, and can radiate radio frequency energy. It may cause harmful interference to radio communications if the equipment is not installed and used following the instructions. However, there is no guarantee that interference will not occur in a particular installation. If this equipment does cause harmful interference to radio or television reception, which can be determined by turning the equipment off and on, the user is encouraged to try to correct the interference by one or more of the following measures:

- Reorient or relocate the receiving antenna.
- Increase the separation between the equipment and receiver.
- Connect the equipment into an outlet on a circuit different from that to which the receiver is connected.
- Consult the dealer or an experienced radio/TV technician for help.

Caution: Any changes or modifications not expressly approved by the grantee of this device could void the user's authority to operate the equipment.

Avertissement FCC

Cet équipement a été testé et déclaré conforme aux limites d'un appareil numérique de classe A, conformément à la partie 15 des règles de la FCC. Ces limites sont conçues pour fournir une protection raisonnable contre les interférences nuisibles dans une installation résidentielle. Cet équipement génère, utilise et peut émettre de l'énergie radiofréquence. Cela peut provoquer des interférences nuisibles aux communications radio si l'équipement n'est pas installé et utilisé conformément aux instructions.

Cependant, il n'y a aucune garantie qu'aucune interférence ne se produira dans une installation particulière. Si cet équipement provoque des interférences nuisibles à la réception radio ou télévision, ce qui peut être déterminé en éteignant puis en rallumant l'équipement, l'utilisateur est encouragé à essayer de corriger les interférences par une ou plusieurs des mesures suivantes:

- Réorientez ou déplacez l'antenne de réception.
- Augmentez la distance entre l'équipement et le récepteur.
- Connectez l'équipement à une prise sur un circuit différent de celui auquel le récepteur est connecté.
- Consultez le revendeur ou un technicien radio / TV expérimenté pour obtenir de l'aide.

CE Mark Warning

This is a Class-A product. In a domestic environment, this product may cause radio interference in which case the user may be required to take adequate measures.

Avertissement de marque CE

Ceci est un produit de classe A. Dans un environnement domestique, ce produit peut provoquer des interférences radio, auquel cas l'utilisateur peut être amené à prendre des mesures adéquates.

Industrial PoE++ Injector

Industrial Grade PoE++ Injector

Hardware Manual

Version 1.0 (November 2021)

The manual supports the following models:

- INJ-C201G-bt-T

This document is the current official release hardware manual. Please check our website (www.antaira.com) for any updated manual or contact us by e-mail (support@antaira.com).

Table of Contents

1 Overview	1
1.1 Product Hardware Features	1
1.2 Package Contents	2
1.3 Safety Precaution	2
2 Hardware Description	4
2.1 Physical Dimensions	4
2.2 Front View Panel	5
2.3 Top View Panel	5
2.4 LED Indicators	6
2.5 Relay Contact Alarm Warning	6
2.6 Ethernet Ports	7
2.7 Cabling	8
2.8 Wiring the Power Inputs	8
2.9 Wiring the Fault Alarm Contact	9
2.10 Grounding Note	10
3 Mounting Installation	11
3.1 DIN-Rail Mounting	11
3.2 Wall Mounting	12
4 Hardware Installation	14
4.1 Installation Steps	14
4.2 Maintenance and Service	15
4.3 Troubleshooting	15
5 Technical Specifications	16

1 Overview

Antaira Technologies' INJ-C201G-bt-T, solves the problem simply by deploying data and power from non-PoE switch and power input to the PD device. PoE injector is a brilliant low-cost solution for the case that only one side of devices is supporting PoE function. Therefore, INJ-C201G-bt-T will be your best choice to deal with the lack of PoE function cases.

Additionally, INJ-C201G-bt-T supports power input from 48VDC to 55VDC, ensuring full 90W PoE output, in compliance with IEEE 802.3bt standard for better usage in various industrial markets, like automation, surveillance and vehicle industry. Besides that, with fan-less design, this model series also works perfectly in polarized temperatures from -40°C to 75°C, and undoubtedly becomes your best option in the harsh environment.

1.1 Product Hardware Features

System Interface and Performance

- Embedded 1*10/100/1000Tx RJ45 port (90W/Port) and 1*10/100/1000Tx RJ45 port
- Support IEEE 802.3af/at/bt Compliant PoE
- Support auto detection and classification for PoE application
- Support short-circuit and current-overloading protection for PoE application

Power Input

- Dual DC 48~55V redundant, with a 4-pin removal terminal block
- Max. current 2A (Included PoE power budget)
- Max. PoE output: 90W
- The power input specification complies with the requirements of SELV (Safety Extra Low Voltage) and the power supply should comply with UL 61010-1 & UL 61010-2-201

Operating Temperature

- Extended operating temperature model: -40°C to 75°C

Case / Installation

- IP30 protection metal housing
- DIN-Rail and wall-mount design
- Installation in a Pollution Degree 2 industrial environment

1.2 Package Contents

- INJ-C201G-bt-T
- Quick Installation Guide
- Wall mounting bracket set with screws
- DC cable - 18AWG & DC jack 5.5 x 2.1mm **Wire: White (+) / Black (-)
- Dust cover set

1.3 Safety Precaution

Attention: If the DC voltage is supplied by an external circuit, please use a protection device on the power supply input. The industrial PoE injector's hardware specs, ports, cabling information, and wiring installation will be described within this hardware manual.

Attention: Si la tension CC est fournie par un circuit externe, veuillez utiliser un dispositif de protection sur l'entrée d'alimentation. Les spécifications matérielles, les ports, les informations de câblage et l'installation du câblage de l'injecteur PoE industriel seront décrits dans ce manuel du matériel.

Warning Labels

The caution label means that you should check certain information on the user manual when working with the device. (Shown in *Figure 1.1*)

Étiquettes d'avertissement

L'étiquette d'avertissement signifie que vous devez vérifier certaines informations du manuel d'utilisation lorsque vous travaillez avec l'appareil. (Illustré à la *figure 1.1*)



Figure 1.1 - Caution Label
Figure 1.1 - Étiquette de mise en garde



Figure 1.2 - Hot Surface Warning Label
Figure 1.2 - Étiquette d'avertissement de surface chaude

2 Hardware Description

2.1 Physical Dimensions

Figure 2.1, below, shows the physical dimensions of this product series:

(W x D x H) is 30mm x 75mm x 95mm

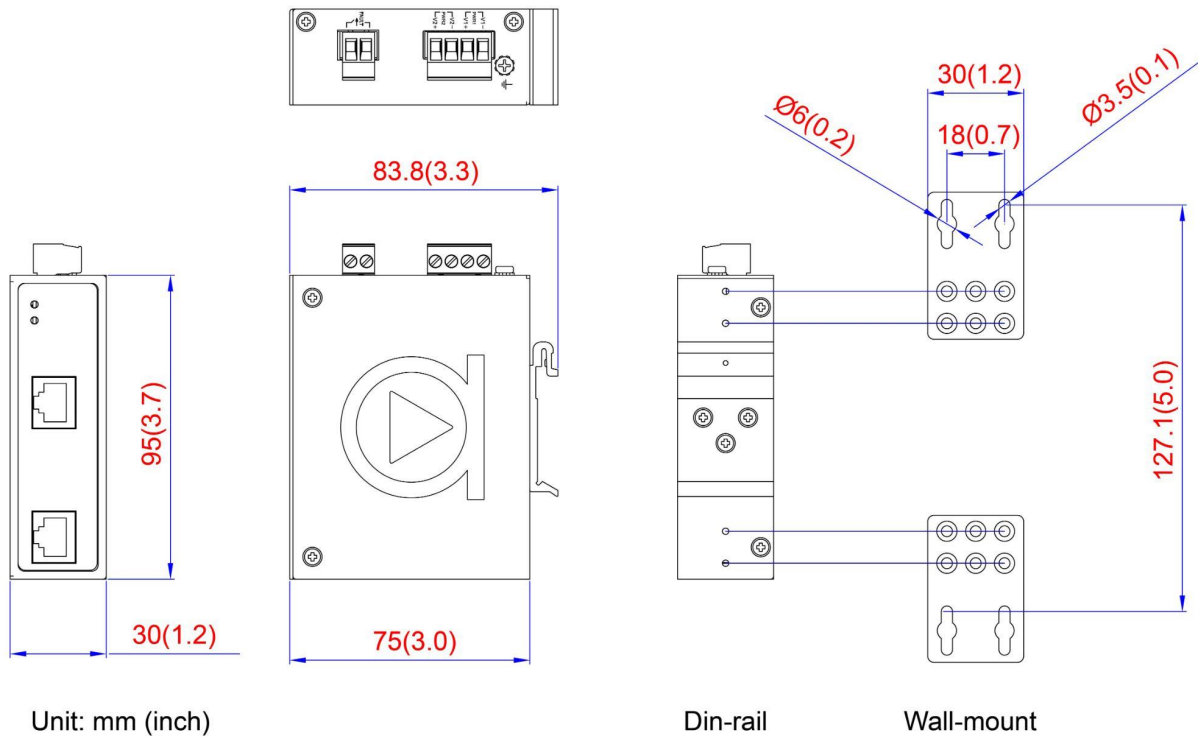

Figure 2.1 - Physical Dimensions

2.2 Front View Panel

Figure 2.2, below, shows the front panel of the product series:

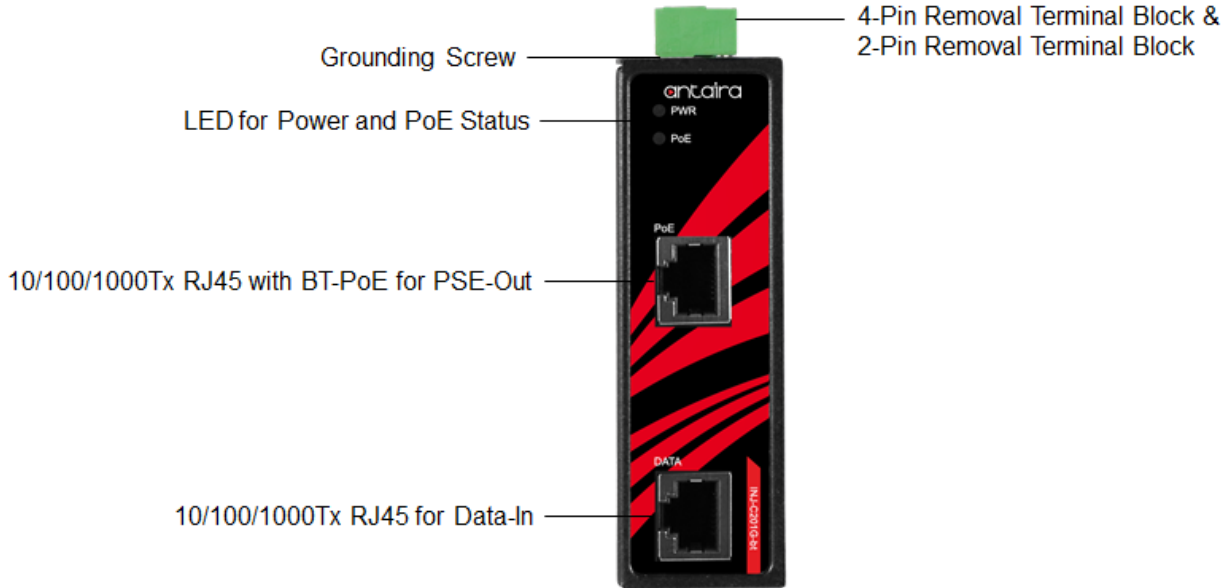

Figure 2.2 - Front View Panel

2.3 Top View Panel

Figure 2.3, below, shows the top panel of the product series:

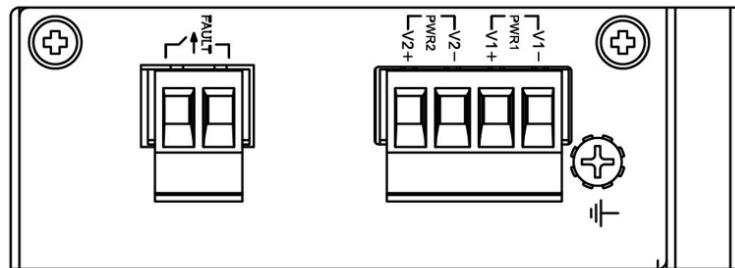

Figure 2.3 - Top View Panel

2.4 LED Indicators

There are LED light indicators located on the front panel of the industrial PoE injector that display the power status and network status. Each LED indicator has a different color and has its specific meaning, see below in *Table 2.1*.

LED	Color	Description	
Power	Green	On	Power input 1 or 2 is active
	Red	On	Power input 1 or 2 is inactive, trigger relay
	-	Off	Power input 1 and 2 is inactive
PoE	Amber	On	The PoE output port is supplying power to the powered-device over 2 pairs
	Green	On	The PoE output port is supplying power to the powered-device over 4 pairs
	-	Off	No powered-device attached or power supplying fails

Table 2.1 - LED Indicators

2.5 Relay Contact Alarm Warning

The relay contact alarm supports power redundancy failed, PoE total output watts >100% warning and PoE over current or cable short warning. There are 5 key trigger events, please follow the below rules: The relay contact alarm will be triggered when any of the listed events occurs.

Key trigger event 1: Power-1 or Power-2 is inactive

Key trigger event 2: PoE total loading >100% PoE output budget

Key trigger event 3: PoE over current per port

Key trigger event 4: Cable short per port

Key trigger event 5: One of the channels in Dual PD fail

[Notice] When the relay is triggered because of Event 2~5, the relay contact alarm will update the status every 30 seconds. If there is no event happening for 30 seconds, the relay contact alarm will be turned off. If the user disables the failed PoE port by removing the cable or Dip Switch manually, the relay will be recovered immediately.

2.6 Ethernet Ports

- **RJ45 Ports**

RJ45 Ports (Auto MDI/MDI-X): The RJ45 ports are auto-sensing for 10Base-T, 100Base-TX, or 1000Base-T connections. Auto MDI means that the switch can connect to another switch or workstation without changing the straight-through or crossover cabling. See the figures below for straight-through and crossover cabling schematics.

- **RJ45 Pin Assignments**

Crossover Cable		Straight Through Cable	
Pin Number / Signal	Pin Number / Signal	Pin Number / Signal	Pin Number / Signal
1 / RX+	3 / TX+	1 / RX+	1 / TX+
2 / RX-	6 / TX-	2 / RX-	2 / TX-
3 / TX+	1 / RX+	3 / TX+	3 / RX+
6 / TX-	2 / RX-	6 / TX-	6 / RX-

Table 2.2 - 10/100Base-T(X) RJ45 Pin Assignments

Crossover Cable		Straight Through Cable	
Pin Number / Signal	Pin Number / Signal	Pin Number / Signal	Pin Number / Signal
1 / TP0+	3 / TP1+	1 / TP0+	1 / TP1+
2 / TP0-	6 / TP1-	2 / TP0-	2 / TP1-
3 / TP1+	1 / TP0+	3 / TP1+	3 / TP0+
4 / TP2+	7 / TP3+	4 / TP2+	4 / TP3+
5 / TP2-	8 / TP3-	5 / TP2-	5 / TP3-
6 / TP1-	2 / TP0-	6 / TP1-	6 / TP0-
7 / TP3+	4 / TP2+	7 / TP3+	7 / TP2+
8 / TP3-	5 / TP2-	8 / TP3-	8 / TP2-

Table 2.3 - 1000Base-T RJ45 Pin Assignments

Note: "+" and "-" signs represent the polarity of the wires that make up each wire pair.

2.7 Cabling

Use the four twisted-pair, category 5e, or the above cabling for the RJ45 port connections. The cable between the injector and the link partner (switch, hub, workstation, etc.) must be less than 100 meters (328 ft.) in length.

2.8 Wiring the Power Inputs



Caution: Please follow the steps below when inserting the power wire.



Attention: Veuillez suivre les étapes ci-dessous lors de l'insertion du câble d'alimentation.

1. Insert the positive and negative wires into the PWR1 (V1+, V1-) and PWR2 (V2+, V2-) contacts on the terminal block connector as shown below in *Figure 2.4*.

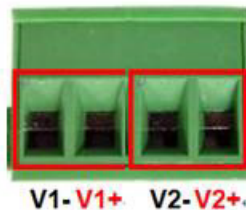

Figure 2.4 - Power Terminal Block

2. Tighten the wire-clamp screws to prevent the wires from loosening, as shown below in *Figure 2.5*.



Figure 2.5 - Power Terminal Block

Caution:



Only use copper conductors, 125°C, tighten to 5 lbs.

The wire gauge for the terminal block should range between 18~20 AWG.

Attention:



Utilisez uniquement des conducteurs en cuivre, 125°C, serrez à 5 lb.

Le calibre des fils du bornier doit être compris entre 18 et 20 AWG.

2.9 Wiring the Fault Alarm Contact

The fault alarm contact is on the 2-pin terminal block connector as the picture shown below. By inserting the wires, it will detect the fault status including power failure or port link failure (managed industrial switch only) and form a normally open circuit. An application example for the fault alarm contact is shown below in *Figure 2.6*.

Insert the wires into fault alarm contact

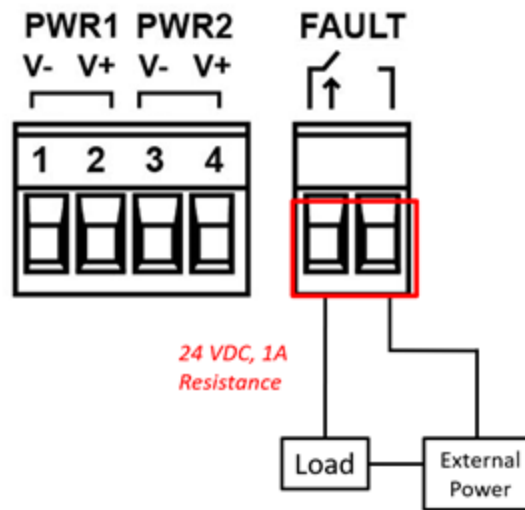

Figure 2.6 - Fault Alarm Contact

2.10 Grounding Note

Grounding and wire routing help limit the effects of noise due to Electromagnetic Interference (EMI). Run the ground connection from the ground screw to the grounding surface before connecting devices. The grounding screw symbol is shown below in *Figure 2.7*.



Figure 2.7 - Grounding Screw Symbol



Caution: Using a shielded cable achieves better electromagnetic compatibility.



Attention: L'utilisation d'un câble blindé permet une meilleure compatibilité électromagnétique

3 Mounting Installation

3.1 DIN-Rail Mounting

The DIN-Rail is pre-installed on the industrial PoE injector from the factory. If the DIN-Rail is not on the industrial PoE injector, please see *Figure 3.1* to learn how to install the DIN-Rail on the injector.

Follow the steps below to learn how to hang the industrial PoE injector:

1. Use the screws to install the DIN-Rail bracket on the rear side of the industrial PoE injector.



Caution: The torque for tightening the screws on the device is 3.5 in-lbs.



Attention: Le couple de serrage des vis sur l'appareil est de 3.5 pouces-livres.

2. To remove the DIN-Rail bracket, do the opposite from step 1.
3. After the DIN-Rail bracket is installed on the rear side of the injector, insert the top of the DIN-Rail onto the track as shown below in *Figure 3.2*.
4. Lightly pull down the bracket onto the rail as shown below in *Figure 3.3*.
5. Check if the bracket is mounted tightly on the rail.
6. To remove the industrial PoE injector from the rail, do the opposite from the above steps.

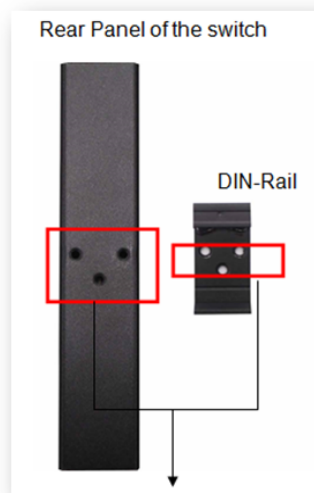

Figure 3.1 - Rear View of the Injector and DIN-Rail



Figure 3.2 - Insert the Injector on the DIN-Rail

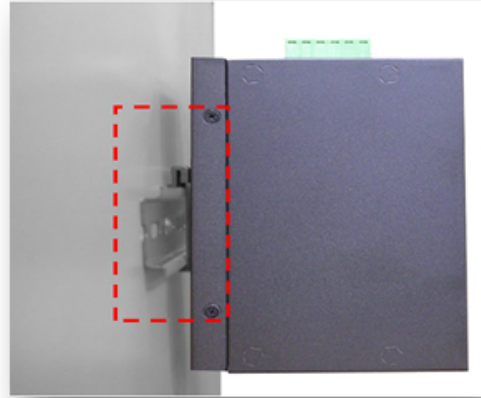

Figure 3.3 - Stable the Injector on the DIN-Rail

3.2 Wall Mounting

Follow the steps below to mount the industrial PoE injector using the wall mounting bracket as shown below in *Figure 3.4*.



Caution: “Wall” means industrial control panel wall



Attention: “Wall” signifie mur de panneau de commande industriel

1. Remove the DIN-Rail bracket from the industrial PoE injector by loosening the screws.
2. Place the wall mounting brackets on the top and bottom of the industrial PoE injector.
3. Use the screws to screw the wall mounting bracket on the industrial PoE injector.



Caution: The torque for tightening the screws on the device is 3.5 in-lbs.



Attention: Le couple de serrage des vis sur l'appareil est de 3.5 pouces-livres.

4. Use the hook holes at the corners of the wall mounting bracket to hang the industrial PoE injector on the wall.
5. To remove the wall mount bracket, do the opposite from the steps above.

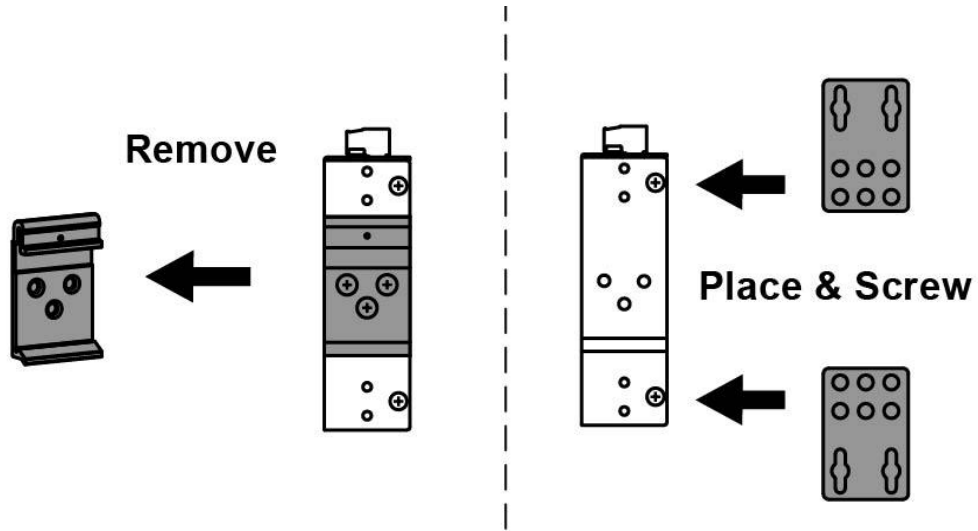

Figure 3.4 - Remove DIN-Rail bracket from the Injector

Below, in Figure 3.5 are the dimensions of the wall mounting bracket.

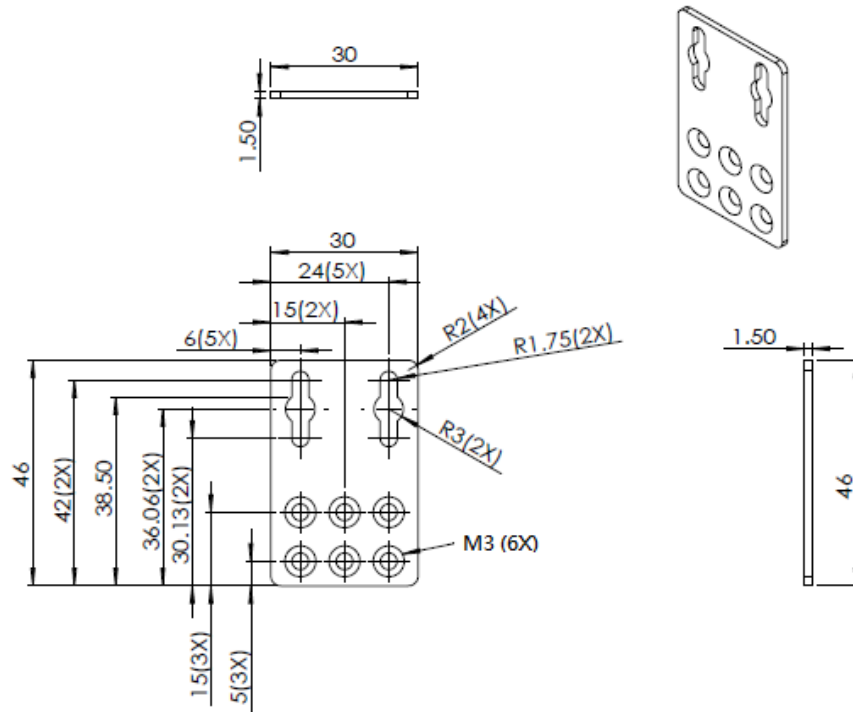

Figure 3.5 - Wall Mounting Bracket Dimensions

4 Hardware Installation

4.1 Installation Steps

This section will explain how to install the industrial PoE injector:



Caution: This device is intended for indoor use.



Attention: Cet appareil est destiné à une utilisation en intérieur.



Caution: The device is intended to be installed in an industrial control enclosure and panel.



Attention: L'appareil est destiné à être installé dans une armoire de commande et un panneau industriels.

Installation Steps

1. Unpack the industrial PoE injector from the original packing box.
2. Check if the DIN-Rail bracket is screwed on the industrial PoE injector.
 - If the DIN-Rail is not screwed on the industrial PoE injector, please refer to the **DIN-Rail Mounting** section for DIN-Rail installation.
 - If it is required to wall mount the industrial PoE injector, please refer to the **Wall Mounting** section for wall mounting installation.
3. To hang the industrial PoE injector on a DIN-Rail or wall, please refer to the **Mounting Installation** section.
4. Power on the industrial PoE injector and then the power LED light will turn on.
 - For the help on how to wire power, please refer to the **Wiring the Power Inputs** section.
 - Please refer to the **LED Indicators** section for LED light indication.
5. Prepare the twisted-pair, straight-through category 5 cable for Ethernet connection.
6. Insert one side of the RJ45 cable into the injector's Ethernet port and on the other side into the networking device's Ethernet port, e.g. switch PC or server.
7. When all connections are set, the installation is complete.

4.2 Maintenance and Service

- If the device requires servicing of any kind, the user is required to disconnect and remove it from its mounting. The initial installation should be done in a way that makes this as convenient as possible.
- Voltage / Power lines should be properly insulated as well as other cables. Be careful when handling them so as to not trip over.
- Do not under any circumstance insert foreign objects of any kind into the heat dissipation holes located in the different faces of the device. This may not only harm the internal layout but might cause harm to users as well.
- Do not under any circumstance open the device for any reason. Please contact your dealer for any repair needed or follow the instructions within the manual.
- Clean the device with a dry soft cloth.

4.3 Troubleshooting

- Always verify the right power cord or adapter is being used. Never use a power supply or adapter with a non-compliant DC output voltage or it will burn the equipment.
- Select the proper UTP or STP cable in order to construct the network. Use an unshielded twisted-pair (UTP) or shield twisted-pair (STP) cable for RJ45 connections: 100Ω Category 5e for 10/100Mbps. Also, be sure that the length of any twisted-pair connection does not exceed 100 meters (328 feet).
- Diagnosing LED Indicators: To assist in identifying problems, the injector can be easily monitored with the LED indicators which help to identify if any problems exist.
 - Please refer to the LED Indicators section for LED light indication.
- If the power indicator LED does not turn on when the power cord is plugged in, the user may have a problem with the power cord. Check for loose power connections, power losses, or surges at the power outlet.
 - Please contact Antaira for technical support service if the problem still cannot be resolved.
- If the industrial injector LED indicators are normal and the connected cables are correct but the packets still cannot transmit, please check the system's Ethernet devices' configuration or status.

5 Technical Specifications

Table 5.1 has the technical specifications for this product series.

Technology	
Standards	IEEE 802.3 10Base-T Ethernet IEEE 802.3u 100Base-TX Fast Ethernet IEEE 802.3ab 1000Base-T Gigabit Ethernet IEEE 802.3af/at/bt Power over Ethernet
Switch Properties	
Transfer Rate	14,880pps for 10Base-T Ethernet 148,800pps for 100Base-T Fast Ethernet 1,488,000pps for Gigabit Ethernet
Port Interface	
Ethernet Port	2*10/100/1000BaseTX (1*Data IN, 1*PoE OUT)
PoE Pin Assignment	V-, V-, V+, V+, for pin 1, 2, 3, 6; V+, V+, V-, V-, for pin 4, 5, 7, 8 *Support Modes: Mode A, Mode B, 4-Pair Mode
LED Indicators	System: Power and PoE
Mechanical Characteristics	
Housing	Metal, IP30 rated
Dimensions	30 x 95 x 75 mm (W x H x D)
Weight	Unit: 0.77 lbs. Shipping: 1.12 lbs.
Mounting	DIN-Rail mounting; Wall mounting
Power Requirement	
Input Voltage	48~55VDC Redundant Input (53~55VDC power input for BT PoE PSE)
Power Connection	1 removable 4-contact terminal block
Overload Current Protection	Present
Reverse Polarity Protection	Present
System Power Consumption	1.6 Watt

Antaira Technologies - Industrial Gigabit PoE++ Injector
INJ-C201G-bt-T - Hardware Manual - v1.0

PoE Power Budget	90 Watts
Environmental Limits	
Operating Temperature	-40°C to 75°C
Storage Temperature	-40°C to 85°C
Ambient Relative Humidity	5 to 95%, (non-condensing)
Regulatory Approvals	
EMI	FCC Part 15 Subpart B Class A CE EN55032/EN61000-6-4 Class A
EMS	CE EN55035/EN61000-6-2 EN61000-4-2,3,4,5,6,8
Free Fall	IEC60068-2-32
Shock	IEC60068-2-27
Vibration	IEC60068-2-6
Green	RoHS Compliant
Certifications	FCC, CE, UL 61010-1 (pending), UL 61010-2-201 (pending)
Compliance	NEMA TS1/TS2
Warranty	5 Years

Table 5.1 - Technical Specifications

Antaira Customer Service and Support

(Antaira US Headquarter) + 844-268-2472

(Antaira Europe Office) +48-22-862-88-81

(Antaira Asia Office) +886-2-2218-9733

Please report any problems to Antaira:

www.antaira.com / support@antaira.com

www.antaira.eu / info@antaira.eu

www.antaira.com.tw / info@antaira.com.tw

Any changes to this material will be announced on the Antaira website.