



## IMP-C1000-SFP Series

10/100/1000TX to 100/1000FX Compact Industrial Gigabit  
Media Converter with SFP Slot and PoE Injector



Version 1.1

## User Manual



[www.antaira.com](http://www.antaira.com)

**© Copyright 2018 Antaira Technologies, LLC.**

All Rights Reserved

This document contains information, which is protected by copyright. Reproduction, adaptation or translation without prior permission is prohibited, except as allowed under the copyright laws.

**Trademark Information**

Antaira is a registered trademark of Antaira Technologies, LLC., Microsoft Windows and the Windows logo are the trademarks of Microsoft Corp. All other brand and product names are trademarks or registered trademarks of their respective owners.

**Disclaimer**

Antaira Technologies, LLC. provides this manual without warranty of any kind, expressed or implied, including but not limited to the implied warranties of merchantability and fitness for a particular purpose. Antaira Technologies, LLC. may make improvements and/or changes to the product and/or specifications of the product described in this manual, without prior notice. Antaira Technologies, LLC. will not be liable for any technical inaccuracies or typographical errors found in this guide. Changes are periodically made to the information contained herein and will be incorporated into later versions of the manual. The information contained is subject to change without prior notice.

## **FCC Notice**

This equipment has been tested and found to comply with the limits for a Class-A digital device, pursuant to Part 15 of the FCC rules. These limits are designed to provide reasonable protection against harmful interference in a residential installation. This equipment generates, uses, and can radiate radio frequency energy. It may cause harmful interference to radio communications if the equipment is not installed and used in accordance with the instructions. However, there is no guarantee that interference will not occur in a particular installation. If this equipment does cause harmful interference to radio or television reception, which can be determined by turning the equipment off and on, the user is encouraged to try to correct the interference by one or more of the following measures:

- Reorient or relocate the receiving antenna.
- Increase the separation between the equipment and receiver.
- Connect the equipment into an outlet on a circuit different from that to which the receiver is connected.
- Consult the dealer or an experienced radio/TV technician for help.

**Caution:** Any changes or modifications not expressly approved by the grantee of this device could void the user's authority to operate the equipment.

## **CE Mark Warning**

This is a Class-A product. In a domestic environment, this product may cause radio interference in which case the user may be required to take adequate measures.

## **Industrial Ethernet Media Converters**

User Manual (March 2018)

This manual supports the following models:

- IMP-C1000-SFP
- IMP-C1000-SFP-T

Please check our website ([www.antaira.com](http://www.antaira.com)) for any updated manual or contact us by e-mail ([support@antaira.com](mailto:support@antaira.com)).

# Table of Contents

|           |                                       |           |
|-----------|---------------------------------------|-----------|
| <b>1.</b> | <b>Overview .....</b>                 | <b>1</b>  |
|           | 1.1 Key Features .....                | 1         |
|           | 1.2 Package Contents .....            | 1         |
|           | 1.3 Safety Precaution .....           | 2         |
| <b>2.</b> | <b>Hardware Description .....</b>     | <b>3</b>  |
|           | 2.1 Physical Dimensions .....         | 3         |
|           | 2.2 Front Panel .....                 | 4         |
|           | 2.3 Top View .....                    | 4         |
|           | 2.4 LED Indicators .....              | 5         |
|           | 2.5 DIP-Switch Setting .....          | 5         |
|           | 2.6 Ethernet Ports .....              | 6         |
|           | 2.7 Cabling .....                     | 6         |
|           | 2.8 Wiring the Power Inputs .....     | 9         |
| <b>3.</b> | <b>Mounting Installation .....</b>    | <b>10</b> |
|           | 3.1 DIN-Rail Mounting .....           | 10        |
|           | 3.2 Wall Mounting .....               | 12        |
| <b>4.</b> | <b>Hardware Installation .....</b>    | <b>13</b> |
|           | 4.1 Installation Steps .....          | 13        |
| <b>5.</b> | <b>Network Application .....</b>      | <b>14</b> |
| <b>6.</b> | <b>Trouble Shooting .....</b>         | <b>15</b> |
| <b>7.</b> | <b>Technical Specifications .....</b> | <b>16</b> |

# 1. Overview

Antaira Technologies' **IMP-C1000-SFP** series is a compact IP-30 rated gigabit Ethernet-to-fiber media converter featuring a 10/100/1000TX Ethernet port that supports IEEE 802.3at high power PoE that can supply up to 30 watts, and a dual rate 100/1000 SFP slot. It is perfectly designed to fulfill industrial applications that require distance extension and high bandwidth capabilities. This small form factor is ideal for saving space in outdoor applications such as factory automation, security, ITS transportation, power/utility, water wastewater treatment plants, and any other extreme ambient weather environments.

The IMP-C1000-SFP series has a built-in "Link Fault Pass Through" (LFP) and "Far End Fault" (FEF) function with 48~55VDC redundant power inputs with reverse polarity and overload current protection. This product series supports DIN-rail as well as wall mountable orientations. There are two operating temperature range models in STD: -10°C to 70°C and EOT: -40°C to 80°C.

## 1.1 Key Features

- System Interface/Performance
  - RJ-45 ports support the auto MDI function
  - Embedded 1-port PoE injection
  - Embedded 1\*10/100/1000Tx (PSE 30W) and 1\*100/1000Fx
  - Store-and-forward switching architecture
- Power Input
  - DC 48~55V redundant power with a 4-pin removal terminal block
- Operating Temperature
  - Standard operating temperature model: -10°C ~ 70°C
  - Extended operating temperature model (-T): -40°C ~ 80°C
- Case/Installation
  - IP-30 protection
  - DIN-Rail and wall mount design

## 1.2 Package Contents

- 1 - Quick Installation Guide
- 1 - IMP-C1000-SFP Industrial Gigabit Media Converter
- 1 - Wall mounting bracket set with screws
- 1 - DC cable - 18 AWG & DC jack 5.5x2.1mm

## **1.3 Safety Precaution**

**Attention:** If the DC voltage is supplied by an external circuit, please use a protection device on the power supply input. The industrial Ethernet media converter's hardware specs, ports, cabling information, and wiring installation will be described within this user manual.

## 2. Hardware Description

### 2.1 Physical Dimensions

Figure 2.1, below, shows the physical dimensions of Antaira Technologies' IMP-C1000-SFP series: 10/100/1000Tx to 100/1000Fx compact industrial gigabit Ethernet media converter.

(W x D x H) is **26mm x 95mm x 75mm**

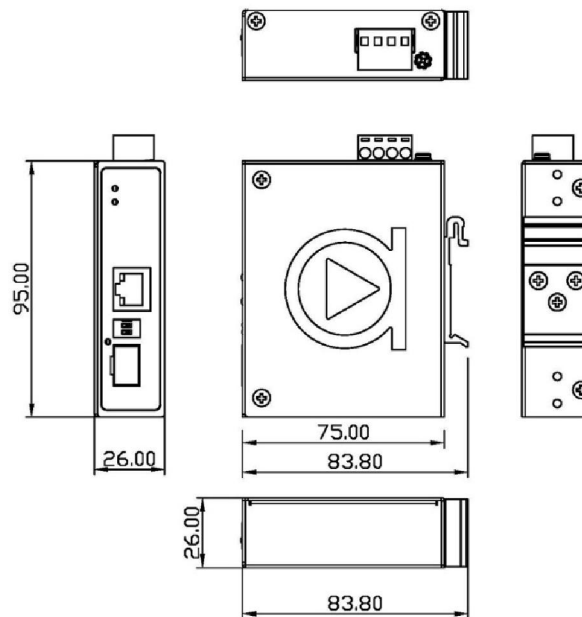


Figure 2.1  
Physical Dimensions

## 2.2 Front Panel

The front panel of the IMP-C1000-SFP series: 10/100/1000Tx to 100/1000Fx industrial compact gigabit Ethernet media converter can be seen below (Figure 2.2).

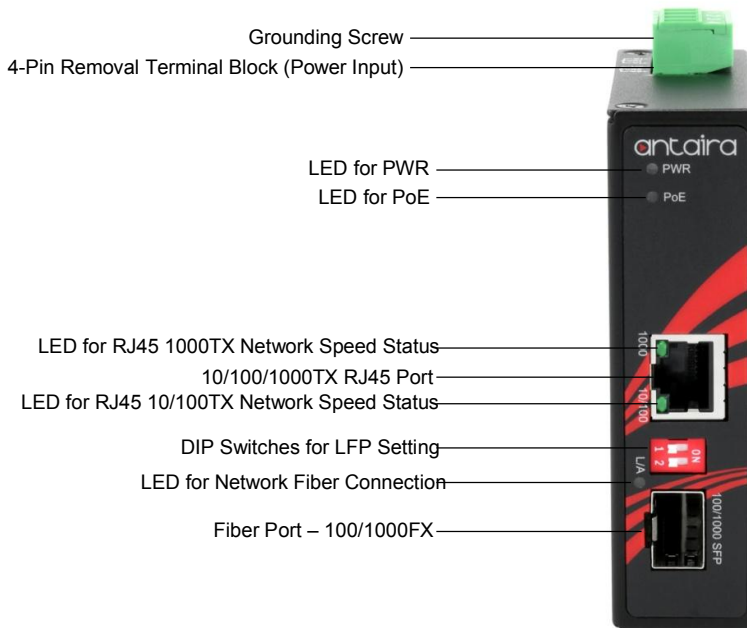


Figure 2.2  
Front Panel

## 2.3 Top View

Figure 2.3, below, shows the top panel of the IMP-C1000-SFP series media converter that is equipped with one 4-pin removal terminal block connector for dual DC power inputs (48~55VDC).

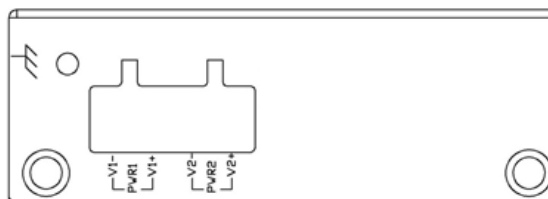


Figure 2.3  
Top Panel View



## 2.4 LED Indicators

There are LED light indicators located on the front panel of the industrial Ethernet media converter that displays the power and network status. Each LED indicator has a different color and has its own specific meaning, see below in *Table 2.1*.

| LED                      | Color | Description |   |
|--------------------------|-------|-------------|---|
| Power                    | Green | On          | Power input 1 or 2 is active                        |
|                          |       | Off         | Power input 1 and 2 are inactive                    |
| LINK/ACT<br>(SFP Slot)   | Green | On          | Connected to network at 100/1000Mbps                |
|                          |       | Flashing    | Networking is active                                |
|                          |       | Off         | Not connected to network                            |
| RJ45 Port<br>(Upper LED) | Green | On          | Linked to network at 1000Mbps                       |
|                          |       | Flashing    | Networking is active                                |
|                          |       | Off         | Not connected to network                            |
| RJ45 Port<br>(Lower LED) | Green | On          | Linked to network at 10/100Mbps                     |
|                          |       | Flashing    | Networking is active                                |
|                          |       | Off         | Not connected to network                            |
| PoE                      | Green | On          | The port is supplying power to the powered-device   |
|                          |       | Off         | No powered-device attached or power supplying fails |

*Table 2.1*  
*LED Indicators*

## 2.5 DIP-Switch Setting

There are 2-sets of DIP-switches on the front panel that can be utilized as an SFP (link fault pass) function and as an SFP transmission rate (see below in *Table 2.2*).

| DIP 1 | DIP 2 | Description                                   |
|-------|-------|---|
| ON    | ON    | LFP Enable and Set SFP to 100Mbps             |
| ON    | OFF   | LFP Enable and Set SFP to 1000Mbps            |
| OFF   | ON    | LFP Disable and Set SFP to 100Mbps            |
| OFF   | OFF   | LFP Disable and Set SFP to 1000Mbps (Default) |

*Table 2.2*  
*DIP-Switch Setting*

## 2.6 Ethernet Ports

### ■ RJ-45 Ports

**RJ-45 Ports (Auto MDI/MDIX):** The RJ-45 port is auto-sensing for 10/100Base-Tx or 1000Base-Tx device connections. Auto MDI/MDIX means that the media converter can connect to another switch or workstation without changing the straight-through or crossover cabling. See the figures shown below for the straight-through and crossover cabling schematics.

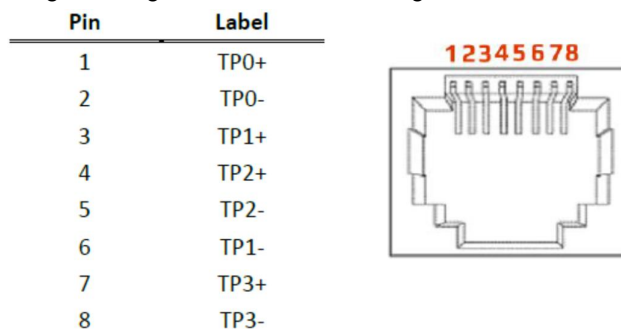


Figure 2.4: RJ-45 Ethernet Port Pin

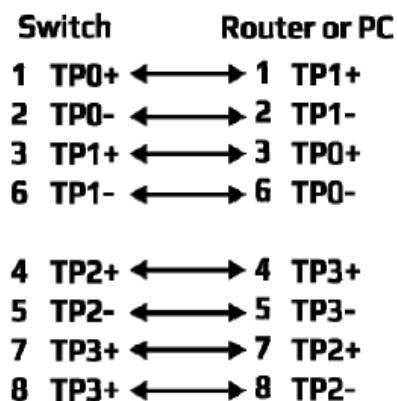


Figure 2.5  
Straight-Through Cables Schematic

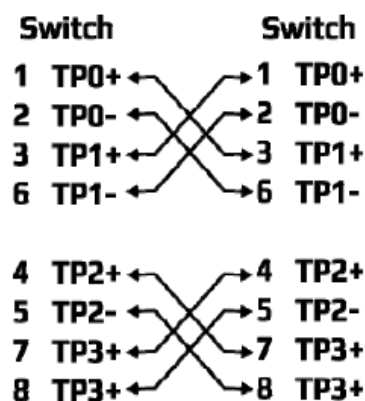
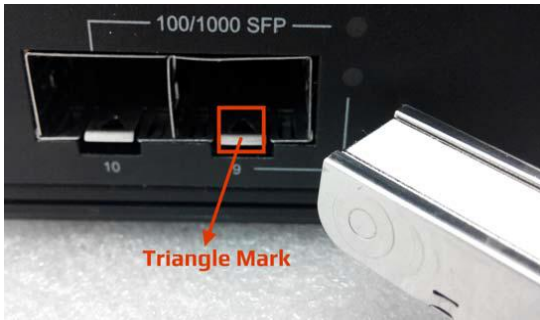


Figure 2.6  
Crossover Cables Schematic

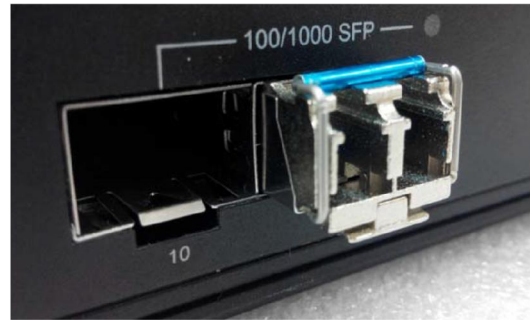
## 2.7 Cabling

- Twisted-pair segments can be connected with an Unshielded Twisted Pair (UTP) or Shielded Twisted Pair (STP) cable. The cable between the equipment and the link partner (media converter, switch, hub, workstation, etc.) must be less than 100 meters (328 ft.) long.
- The Small Form Factor pluggable (SFP) is a compact optical transceiver used in optical communications for both telecommunication and data communication applications.

- To connect the transceiver and LC cable, please follow the steps below:
  - **Step 1** - Insert the SFP transceiver module into the SFP slot as shown below in *Figure 2.7*. Notice that the triangle mark is at the bottom of the SFP slot. *Figure 2.8* shows the SFP transceiver module was inserted.

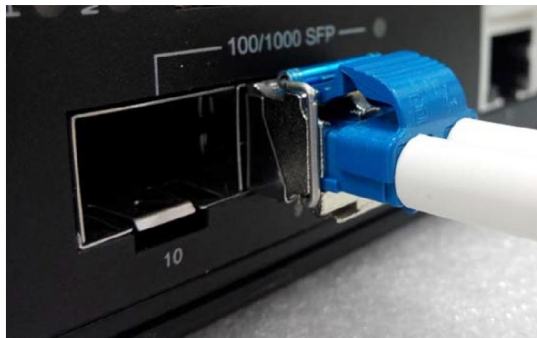


*Figure 2.7 - Transceiver to the SFP Slot*



*Figure 2.8 - Transceiver Inserted*

- **Step 2** - Insert the fiber cable of the LC connector into the transceiver as shown below in *Figure 2.9*.



*Figure 2.9 - LC Connector to the Transceiver*

- To remove the LC connector from the transceiver, please follow the steps shown below:
  - **Step 1** - Press the upper side of the LC connector from the transceiver and pull it out to release as shown below in *Figure 2.10*.
  - **Step 2** - Push down the metal clasp and pull the transceiver out by the plastic part as shown below in *Figure 2.11*.

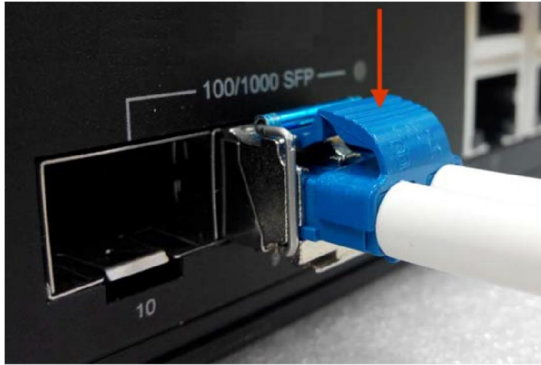


Figure 2.10 – Remove LC Connector

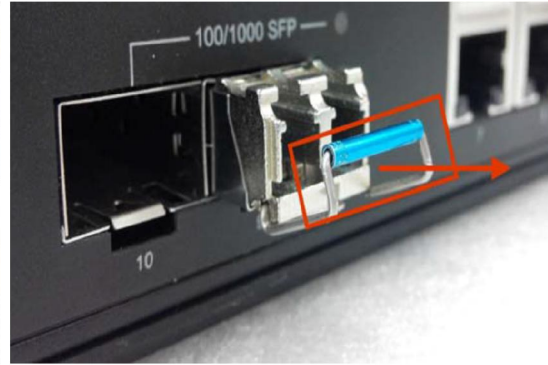
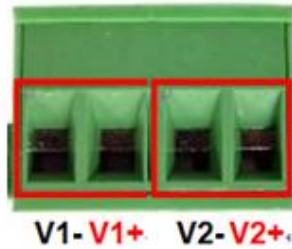


Figure 2.11 – Pull Out from SFP Slot

## 2.8 Wiring the Power Inputs

Please follow the steps below to insert the power wire.

1. Insert the positive and negative wires into the PWR1 (V1+, V1-) and PWR2 (V2+, V2-) contacts on the terminal block connector as shown below in *Figure 2.12*.



*Figure 2.12*  
Power Terminal Block

2. Tighten the wire-clamp screws to prevent the wires from loosening, as shown below in *Figure 2.13*.



*Figure 2.13*  
Power Terminal Block

- 
- \*\*Note:**
- Only use copper conductors, 60/75°C, tighten to 5 lbs.
  - The wire gauge for the terminal block should range between 18~20 AWG.
-

## 3. Mounting Installation

### 3.1 DIN-Rail Mounting

The DIN-Rail is pre-installed on the industrial Ethernet media converter from the factory. If the DIN-Rail is not on the industrial Ethernet media converter, please refer to *Figure 3.1* to learn how to install the DIN-Rail on the media converter.

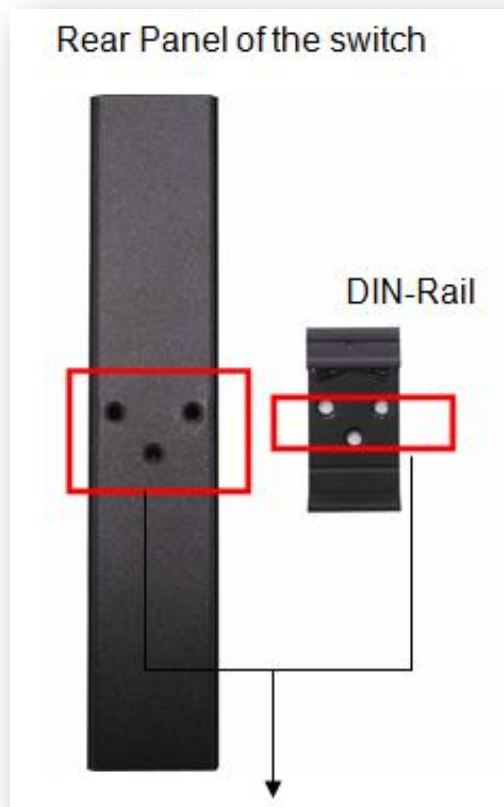


Figure 3.1

*The Rear Side of the Media Converter and DIN-Rail Bracket*

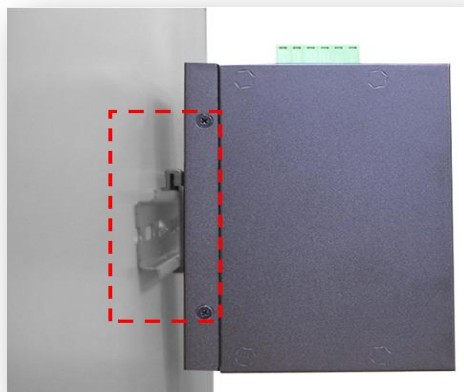
Follow the steps below to learn how to hang the industrial Ethernet media converter.

1. Use the screws to install the DIN-Rail bracket on the rear side of the industrial Ethernet media converter.
2. To remove the DIN-Rail bracket, do the opposite from step 1.
3. After the DIN-Rail bracket is installed on the rear side of the media converter, insert the top of the DIN-Rail onto the track as shown below in *Figure 3.2*.



*Figure 3.2*  
*Insert on the DIN-Rail*

4. Lightly pull down the bracket onto the rail as shown below in *Figure 3.3*.



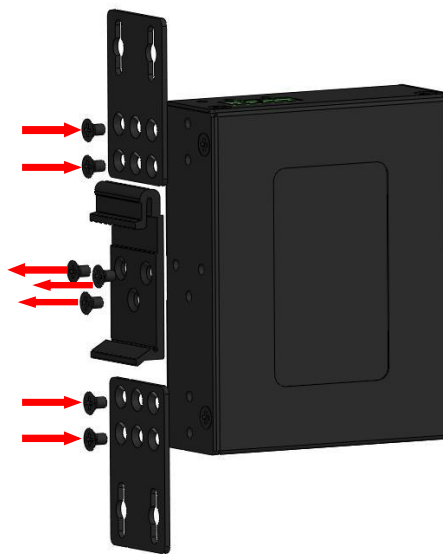
*Figure 3.3*  
*Secure on to the DIN-Rail*

5. Check if the bracket is mounted tightly on the rail.
6. To remove the industrial Ethernet media converter from the rail, do the opposite from the above steps.

## 3.2 Wall Mounting

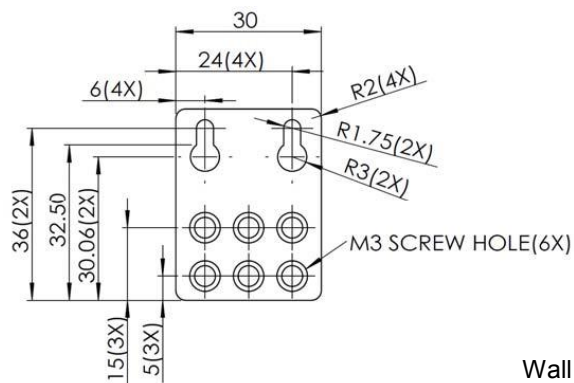
Follow the steps below to mount the industrial Ethernet media converter using the wall mounting bracket as shown below in *Figure 3.4*.

1. Remove the DIN-Rail bracket from the industrial media converter by loosening the screws.
2. Place the wall mounting brackets on the top and bottom of the industrial media converter.
3. Use the screws to screw the wall mounting bracket on the industrial media converter.
4. Use the hook holes at the corners of the wall mounting bracket to hang the industrial Ethernet media converter on the wall.
5. To remove the wall mount bracket, do the opposite from the steps above.



*Figure 3.4*  
Remove DIN-Rail Bracket

Below, in *Figure 3.5* are the dimensions of the wall mounting bracket.



*Figure 3.5*  
Wall Mounting Bracket Dimensions



## 4. Hardware Installation

### 4.1 Installation Steps

This section will explain how to install Antaira Technologies' IMP-C1000-SFP (-T) series: 10/100/1000Tx to 100/1000Fx industrial compact gigabit Ethernet media converter.

#### Installation Steps

1. Unpack the industrial media converter from the original packing box.
2. Check if the DIN-Rail bracket is screwed on the industrial media converter.
  - a. If the DIN-Rail is not screwed on the industrial media converter, please refer to the **DIN-Rail Mounting** section for DIN-Rail installation.
  - b. For wall mounting, please refer to the **Wall Mounting** section for wall mounting installation.
3. For DIN-Rail or wall mounting, please refer to the **Mounting Installation** section.
4. Power on the industrial media converter; the power LED light will turn on.
  - a. For wiring power, please refer to the **Wiring the Power Inputs** section.
  - b. Please refer to the **LED Indicators** section for LED light indication.
5. Prepare the twisted-pair, straight-through category 5 cable for Ethernet connection.
6. Insert one side of the RJ-45 cable into the media converter's Ethernet port and on the other side into the networking device's Ethernet port, e.g. switch PC or server. The Ethernet port's (RJ-45) LED on the industrial media converter will turn on when the cable is connected to the networking device.
  - a. Please refer to the **LED Indicators** section for LED light indication information.
7. Insert one side of the SFP cable into the media converter's SFP port and on the other side into the networking device's SFP port, e.g. switch or server. The SFP port's LED on the industrial media converter will turn on when the cable is connected to the networking device.
  - a. Please refer to the **LED Indicators** section for LED light indication information.
8. When all connections are set and the LED lights all show normal, the installation process is complete.

## 5. Network Application

This segment provides an example of an industrial Ethernet media converter application (Figure 5.1).

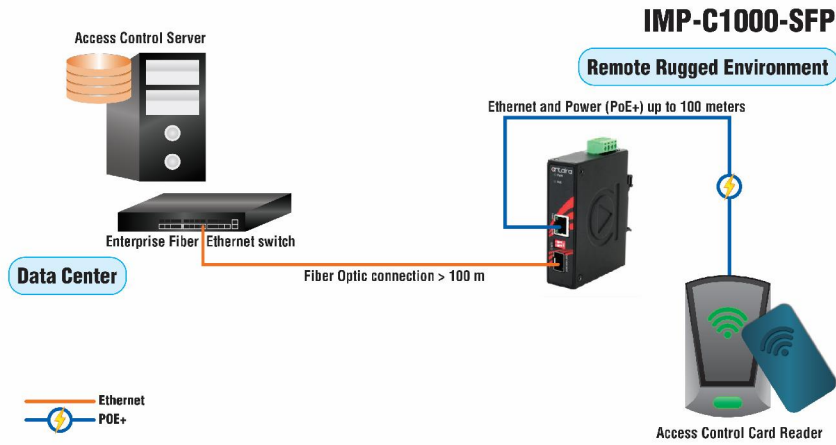


Figure 5.1  
Industrial Gigabit Media Converter  
Application Example

## 6. Trouble Shooting

- Always verify the right power cord or adapter is being used. Never use a power supply or adapter with a non-compliant DC output voltage or it will burn the equipment.
- Select the proper UTP or STP cable in order to construct the network. Use an Unshielded Twisted-Pair (UTP) or Shield Twisted-Pair (STP) cable for RJ-45 connections: 100Ω Category 5e for 10/100/1000Mbps. Also be sure that the length of any twisted-pair connection does not exceed 100 meters (328 feet).
- **Diagnosing LED Indicators:** To assist in identifying problems, the media converter can be easily monitored with the LED indicators which help to identify if any problems exist.
  - Please refer to the LED Indicators section for LED light indication information.
- If the power indicator LED does not turn on when the power cord is plugged in, the user may have a problem with the power cord. Check for loose power connections, power losses or surges at the power outlet.
  - Please contact Antaira for technical support if the problem cannot be resolved.
- If the industrial media converter LED indicators are normal and the connected cables are correct but the packets still cannot transmit, please check the system's Ethernet devices' configuration or status.

## 7. Technical Specifications

Table 7.1 has the technical specifications for Antaira Technologies' IMP-C1000-SFP series: 10/100/1000Tx to 100/1000Fx w/ 1 PoE injector industrial compact Gigabit Ethernet media converter.

|                                   |                       |  |
|-----------------------------------|-----------------------|--|
| <b>Standards</b>                  | IEEE 802.3            | 10Base-T 10Mbit/s Ethernet   |
|                                   | IEEE 802.3u           | 100Base-TX, Fast Ethernet  |
|                                   | IEEE 802.3ab          | 1000Base-TX Gigabit Ethernet   |
|                                   | IEEE 802.3af          | Power-over-Ethernet  |
|                                   | IEEE 802.3at          | Power-over-Ethernet Plus (Enhanced)  |
|                                   | IEEE 802.3u           | 100Base-FX, Fast Fiber   |
|                                   | IEEE 802.3z           | 1000Base-X Gigabit Fiber   |
| <b>Technology</b>                 | Protocol              | CSMA/CD  |
|                                   | Data Process          | Store and Forward  |
|                                   | Transfer Rate         | 14,880 pps for 10Base-T Ethernet port<br>148,800 pps for 100Base-TX Fast Ethernet port<br>1,488,000 pps for Gigabit Ethernet port  |
|                                   | Transmission Distance | Up to 100m (Ethernet) ; Up to 120Km for fiber dependent on SFP   |
|                                   | Transmission Speed    | Up to 1000Mbps   |
| <b>Port Interface</b>             | Ethernet (RJ45) Port  | 1*10/100/1000Tx auto negotiation speed, full/half duplex mode, and auto MDI connection   |
|                                   | Fiber Port            | 1*100/1000Fx SFP Slot  |
|                                   | Fiber Wavelength      | Refer to SFP Module  |
|                                   | DIP Switch            | DIP Switch 1: LFP(Link Fault Pass) Enable/Disable<br>DIP Switch 2: 1000Mbps / 100Mbps  |
|                                   | LED Indicator         | 1000: On (Ethernet 1000Mbps Link). Flashing (networking is active)<br>10/100: On (Ethernet 10/100Mbps Link). Flashing (networking is active)<br>L/A: SFP Link/Active                                     |
|                                   | Network Cable         | 10BaseT: 2-pair UTP/STP Cat.3,4,5 cable EIA/TIA-568 100-ohm (100m)<br>100BaseTX: 2-pair UTP/STP Cat.5 cable EIA/TIA-568 100-ohm (100m)<br>1000BaseTX: UTP/STP Cat. 5/5e cable EIA/TIA-568 100-ohm (100m) |
|                                   | PoE Pin Assignment    | RJ-45 port # 1~# 4 support IEEE 802.3af End-point, Alternative A mode.<br>Positive (VCC+): RJ-45 pin 1, 2. Negative (VCC-): RJ-45 pin 3, 6. Data (1,2,3,6 )  |
| <b>Mechanical Characteristics</b> | Housing               | Metal IP30 protection  |
|                                   | Dimension             | 26 x 95 x 75 mm  |
|                                   | Weight                | Unit Weight: 0.55 lbs. Shipping Weight: 0.99 lbs.  |
|                                   | Mounting              | DIN-Rail Mounting, wall-mounting (optional)  |
| <b>Power Requirement</b>          | Input Voltage         | 48~55VDC Redundant Input   |
|                                   | Power Connection      | 1 removable 4-contact terminal block   |
|                                   | Power Consumption     | 3 Watts  |
| <b>Environmental Limits</b>       | Operating Temperature | Standard: -10°C to 70°C (14°F to 158°F)<br>EOT: -40°C to 80°C (-40°F to 176°F)   |
|                                   | Operating Humidity    | 5% to 95% (Non-Condensing)   |
|                                   | Storage Temperature   | -40°C to 85°C (-40°F ~ 185°F)  |
| <b>Regulatory</b>                 | EMI / EMS             | FCC Part 15 Subpart B Class A, CE EN 55022 Class A, CE EN 55022  |

|                  |                   |   |
|------------------|-------------------|---|
| <b>Approvals</b> |                   | Class A, IEC61000-4-2(ESD),IEC61000-4-3(RS),<br>IEC61000-4-4(EFT),IEC61000-4-5(Surge),<br>IEC61000-4-6(CS),IEC61000-4-8(Magnetic Field) |
|                  | Stability Testing | IEC60068-2-32(Free Fall), 27(Shock), 6(Vibration)   |
|                  | Safety            | CE, FCC, UL 61010-1, UL 61010-2-201   |

*Table 7.1*  
*Technical Specifications*

**Antaira Customer Service and Support**

(Antaira US Headquarter) + 844-268-2472

(Antaira Europe Office) + 48-22-862-88-81

(Antaira Asia Office) + 886-2-2218-9733

**Please report any problems to Antaira:**

[www.antaira.com](http://www.antaira.com) / [support@antaira.com](mailto:support@antaira.com)

[www.antaira.eu](http://www.antaira.eu) / [info@antaira.eu](mailto:info@antaira.eu)

[www.antaira.com.tw](http://www.antaira.com.tw) / [info@antaira.com.tw](mailto:info@antaira.com.tw)

**Any changes to this material will be announced on the Antaira website.**