



Wireless  
Broadband  
Alliance



# 2024 WBA Industry Report

---

**Source:**

Wireless Broadband Alliance

---

**Lead Author:**

Adlane Fellah, Maravedis LLC

---

**Author:**

Alex Davies, Rethink Research

---

**Issue date:**

November 2023

---

**Version:**

Final

## About the Wireless Broadband Alliance

Wireless Broadband Alliance (WBA) is the global organization that connects people with the latest Wi-Fi initiatives. Founded in 2003, the vision of the WBA is to drive seamless, interoperable service experiences via Wi-Fi within the global wireless ecosystem. WBA's mission is to enable collaboration between service providers, technology companies, cities, regulators and organizations to achieve that vision.

WBA undertakes programs and activities to address business and technical challenges, while exploring opportunities for its member companies. These initiatives encompass standards development, industry guidelines, trials, certification, and advocacy. Its key programs include NextGen Wi-Fi, OpenRoaming, 5G, IoT, Smart Cities, Testing & Interoperability and Policy & Regulatory Affairs, with Member-led Work Groups dedicated to resolving standards and technical issues to promote end-to-end services and accelerate business opportunities.

[Membership](#) in the WBA includes major operators, service providers, enterprises, hardware and software vendors, and other prominent companies that support the ecosystems from around the world. The [WBA Board](#) comprises influential organizations such as Airties, AT&T, Boingo Wireless, Boldyn Networks, Broadcom, BT, Cisco Systems, Comcast, Intel, Reliance Jio, Turk Telekom, and Viasat.

### Follow Wireless Broadband Alliance:

[www.twitter.com/wballiance](http://www.twitter.com/wballiance)

<http://www.facebook.com/WirelessBroadbandAlliance>

<https://www.linkedin.com/company/2919934>

## About Maravedis

Maravedis is a boutique wireless infrastructure analyst firm founded in 2002. Maravedis focuses on broadband wireless technologies with a particular focus on Wi-Fi, cellular and IoT as well as industry spectrum regulations and operator trends. Its mission is to research, analyze, and provide guidance on the role of unlicensed technologies in the overall connectivity space.

For more information, visit [www.maravedis-bwa.com](http://www.maravedis-bwa.com).

## About Rethink

Rethink Technology Research is a research and strategic advisory company focused on operator networks and business models in telecoms and digital video markets. Its forecasts and analysis are based on foundational intellectual property that has been developed and refined over 20 years, including a unique opt-in research panel of senior executives within Tier 1 and 2 telcos worldwide. Particular areas of expertise in wireless include 5G, Wi-Fi, network virtualisation and monetisation models.

## Disclaimer

Maravedis LLC, Rethink Technology Research and Wireless Broadband Alliance (WBA) makes no warranties express or implied as to the results to be obtained from use of this research material and makes no warranties expressed or implied of suitability or fitness for a particular purpose. Maravedis LLC, Rethink Technology Research and WBA shall have no liability to the recipient of this research material or to any third party for any indirect, incidental, special or consequential damages arising out of use of this research material. This Document and all the information contained in this Document is provided on an 'as is' basis without warranty of any kind, either expressed or implied, including, but not limited to, the implied warranties of merchantability, fitness for particular purpose, or non-infringement. In addition, the WBA (and all other organisations who may have contributed to this document) makes no representations or warranties about the accuracy, completeness, or suitability for any purpose of the information. The information may contain technical inaccuracies or typographical errors. All liabilities of the WBA (and all other organisations who may have contributed to this document) howsoever arising for any such inaccuracies, errors, incompleteness, suitability, merchantability, fitness and non-infringement are expressly excluded to the fullest extent permitted by law. None of the contributors make any representation or offer to license any of their intellectual property rights to the other, or to any third party. Nothing in this information or communication shall be relied on by any recipient. The WBA also disclaims any responsibility for identifying the existence of or for evaluating the applicability of any claimed copyrights, patents, patent applications, or other intellectual property rights, and will take no position on the validity or scope of any such rights. The WBA takes no position regarding the validity or scope of any intellectual property or other rights that might be claimed to pertain to the implementation or use of the technology described in this document or the extent to which any license under such rights might or might not be available; nor does it represent that it has made any effort to identify any such rights. Neither the WBA nor any of the other organisations who may have contributed to this document will be liable for loss or damage arising out of or in connection with the use of this information. This is a comprehensive limitation of liability that applies to all damages of any kind, including (without limitation) compensatory, direct, indirect or consequential damages, loss of data, income or profit, loss

# Table of Contents

<b>1.</b>	<b>Executive Summary</b>	<b>7</b>
<b>2.</b>	<b>Interview with WBA Chairman</b>	<b>9</b>
2.1	Looking back over the past year, what are the most significant achievements of the WBA?	9
2.2	What will be the biggest challenges for the WBA to address in the year ahead, and how will these be best met?	9
2.3	What are the most critical evolutions in Wi-Fi technology which will expand business opportunities in the next decade?	9
2.4	What is your assessment of the progress made by OpenRoaming™ so far?	10
2.5	How is WBA helping AT&T to support and develop its mobility business, including Wi-Fi Offload and Wi-Fi Roaming especially considering the launch of OpenRoaming™?	10
2.6	Finally, when we write the 2025 industry report, what do you hope the WBA and the wider Wi-Fi community will have achieved the most?	10
<b>3.</b>	<b>Interview with Tiago Rodrigues, President and Chief Executive Officer at the WBA</b>	<b>11</b>
3.1	What are the most exciting programs the WBA is working on?	11
3.2	What can you tell us about the momentum the WBA is currently enjoying?	12
3.3	What do the next 18 months hold for the OpenRoaming federation?	12
3.4	Sustainability is becoming increasingly crucial in Wi-Fi networks; what can you tell us about sustainability progress?	12
3.5	Tell us about World Wi-Fi Day.	13
3.6	What would you say to those not yet familiar with the work of the WBA?	13
<b>4.</b>	<b>Key Market Segments and the Impact of Wi-Fi</b>	<b>14</b>
4.1	Residential Wi-Fi	14
4.2	Enterprise Wi-Fi	15
4.2.1	<i>Hospitality</i>	16
4.2.2	<i>Stadia and Conference Venues</i>	17
4.2.3	<i>Retail (Including Coffee Shops and F&amp;B)</i>	17
4.2.4	<i>Aviation (Airlines, Airports, and Supporting Infrastructure)</i>	17
4.2.5	<i>Ground Transportation</i>	18
4.2.6	<i>Smart Transportation and Connected Vehicles</i>	18
4.2.7	<i>Industrial and Manufacturing</i>	19
4.2.8	<i>Education</i>	20

4.2.9	Healthcare	20
4.2.10	Multi-Dwelling Units	21
4.3	Connected Cities and Public Spaces	21
4.4	Rural Wi-Fi	22
<b>5.</b>	<b>Wi-Fi Technology Evolution</b>	<b>25</b>
5.1	Key Updates on Wi-Fi Standards	25
5.2	Key Technology Innovation	28
5.2.1	Evolution to Deterministic Wi-Fi	28
5.3	ID Management	29
5.4	Wi-Fi Enablers	29
5.4.1	AI/ML for Wi-Fi	29
5.4.2	New Possibilities with Wi-Fi Sensing	30
5.4.3	Extended Realities — Applications and Drivers	30
5.4.4	Wi-Fi and IoT	31
5.4.5	The Case for HaLow	32
5.4.6	Wi-Fi Security and Privacy Issues	32
5.4.7	TIP OpenWiFi Recent Developments	33
5.4.8	Other Enablers	33
<b>6.</b>	<b>Top 10 Predictions Covering Next 3-Year Time Horizon</b>	<b>34</b>
6.1	Wi-Fi 6/6E	34
6.2	Wi-Fi 7	34
6.3	OpenRoaming	34
6.4	Network as a Service	34
6.5	AI/ML	34
6.6	AFC	35
6.7	New IoT Tech	35
6.8	TIP OpenWiFi	36
6.9	Metaverse	36
6.10	Wi-Fi and 5G/6G Convergence	36
<b>7.</b>	<b>Convergence of Wi-Fi and Other Radio Access Technologies</b>	<b>37</b>
7.1	Wi-Fi 6E, 7, & 5G – Convergence & Key Milestones	37
7.1.1	Wi-Fi Alignment with 5G and 5G New Radio Unlicensed (NRu)	39
7.1.2	Wi-Fi plus CBRS and Private 5G – how should they best be used?	40

7.2	New Role of Wi-Fi in 6G	42
7.3	Wi-Fi and the Internet of Things	43
7.4	Private LTE aligned with Wi-Fi	44
<b>8.</b>	<b>Spectrum and Regulatory</b>	<b>45</b>
8.1	6 GHz Extension for Wi-Fi	45
8.2	Coordinated Shared Spectrum Models	46
8.3	Automated Frequency Coordination	46
8.4	Regulatory & Spectrum Framework for 5G with Unlicensed Bands	48
<b>9.</b>	<b>WBA Programs and Projects — 2023/2024</b>	<b>49</b>
9.1	The Rise of WBA OpenRoaming	49
9.2	Wi-Fi 7 Advocation & Trials	49
9.3	Operator Managed Wi-Fi (OMWi) – Reference Architecture	50
9.4	5G and Wi-Fi Convergence	51
9.5	Improving Wi-Fi Experience in Moving Networks	51
9.6	IoT & Smart Home	51
9.7	Access Network Metrics (QoE) and E2E Wi-Fi QoS	51
9.8	Venue Requirements for User Engagement	52
9.9	Wi-Fi HaLow for IoT Applications	52
<b>10.</b>	<b>Sustainability and World Wi-Fi Day — Charter and Progress</b>	<b>53</b>
<b>11.</b>	<b>Industry Survey — Findings, Summary, and Implications</b>	<b>54</b>
<b>12.</b>	<b>Case Studies</b>	<b>59</b>
12.1	OpenRoaming Takes Center Stage in Tokyo	59
12.2	Powering the Shenzhen Talent Institute with Wi-Fi 7	61

# Table of Figures

<i>Figure 1: Applications Driving Data Traffic by Subscriber Segment 2Q2023.</i>	14
<i>Figure 2: Enterprise NaaS, Enterprise Infrastructure as A Service, and Managed Services</i>	16
<i>Figure 3: Applications Driving Data Traffic by Subscriber Segment - 2Q23</i>	16
<i>Figure 4: Industrial and Manufacturing</i>	19
<i>Figure 5: Healthcare OpenRoaming Results</i>	20
<i>Figure 6: Managed Wi-Fi MDU Deployment Matrix</i>	21
<i>Figure 7: OpenRoaming/CityRoam</i>	22
<i>Figure 8: Percentage of individuals using the internet in urban and rural areas 2019-2022</i>	23
<i>Figure 9: IEEE 802.11 Wi-Fi standard MAC/PHY evolution</i>	26
<i>Figure 10: Wi-Fi Device Tracker</i>	26
<i>Figure 11: Wi-Fi Device Tracker Histroy - Q2'2023</i>	27
<i>Figure 12: Determinism... Expanding Wireless Use-Cases</i>	28
<i>Figure 13: Research Interest in ML &amp; 802.11</i>	30
<i>Figure 14: XR Remote rendering requires management of ALL Wi-Fi links</i>	31
<i>Figure 15: HaLow use cases.</i>	32
<i>Figure 16: AFC timeline</i>	35
<i>Figure 17: The Wi-Fi Alliance map of 6E spectrum allocations.</i>	38
<i>Figure 18: Spectrum Sharing in 5G New Radio Specifications</i>	40
<i>Figure 19: Preferred wireless connectivity strategy 2022-2026</i>	41
<i>Figure 20: Preferred IoT Connectivity Strategies for enterprises in Selected scenarios</i>	44
<i>Figure 21: Role of Open AFC Software</i>	47
<i>Figure 22: Technical Activities Roadmap for 2023</i>	49
<i>Figure 23: Capabilities of latest Wi-Fi (6/6E/7) and IMT generations (IMT-Advanced (4G) and IMT-2020 (5G))</i>	50
<i>Figure 24: How was your confidence towards investing in Wi-Fi changed over the last 12 months?</i>	54
<i>Figure 25: Top 3 drivers for investing in a Passpoint and/or OpenRoaming™ compliant network.</i>	55
<i>Figure 26: 3 most important and new improved features for Wi-Fi 6 or Wi-Fi 7.</i>	56
<i>Figure 27: Major gaps for delivering In-Home Wi-Fi services in line with customer expectations?</i>	57
<i>Figure 28: Top 3 areas where you expect to see the greatest growth in terms of traffic in the next 12 months.</i>	57
<i>Figure 29: Expand awareness and usage opportunities through collaboration with online and offline media.</i>	60

# 1. Executive Summary

There are around 20 billion Wi-Fi devices in use today, and the economic value of Wi-Fi is an estimated \$4 trillion. Wi-Fi continues to enjoy significant industry momentum with the drive into the 6 GHz band being the most impressive current factor. Wi-Fi 6E has enjoyed strong market adoption, as has the [OpenRoaming](#) specification. As more regulators the world over discuss opening up even more of the 6 GHz band for Wi-Fi, it will trigger a new wave of momentum.

According to OpenVault, the average bandwidth usage across U.S. broadband households is now a staggering 533.8 GB, up from 513.8 GB in Q2 2022. Users consume ever-increasing bandwidth-hungry and latency-sensitive applications, such as 4K streaming, online gaming, and immersive experiences. We are entering a new world where residential power users' have access to multigigabit connectivity.

Enterprises in all sectors are pursuing their digital transformation which requires next generation connectivity across their digital processes with the latest Wi-Fi technology. Industries ranging from healthcare to hospitality to smart cities and transportation are leveraging new Wi-Fi capabilities to support new use cases and business models. The pace of digital transformation in the wake of Covid-19 and the societal shifts that occurred because of it has accelerated. Wi-Fi remains core to unlocking new business opportunities and efficiency gains. Network as a Service (NaaS) is rising and promises to reshape enterprises' relationships with their overall wireless infrastructure and usage models.

Regarding public Wi-Fi and guest Wi-Fi, the strong collaboration within the Wi-Fi industry has continued again in 2023, with OpenRoaming reaching 3.5 million hotspots deployed by over 650 organizations – strengthening the position of Wi-Fi via the ability to connect between Wi-Fi networks securely and working its way towards integrating both IoT and private 5G networks.

[Wi-Fi 7](#) is adding many more capabilities to Wi-Fi, and it is nearing the completion of the IEEE 802.11be Extremely High Throughput (EHT) standard. Wi-Fi 7 brings three new key features: an increase in channel size from 160 to 320 MHz, which doubles the throughput, 4K quadrature amplitudes modulation (QAM), which translates to a 20 percent increase in peak performance and multi-link operations (MLO) for aggregated spectrum in dual bands. Wi-Fi 7 will take full advantage of the 6GHz spectrum, which is now partially open in over 50 countries, to make the Wi-Fi performance much more deterministic for latency-sensitive and high bandwidth applications such as XR and 4K video.

Outside the work of standard organizations, industry innovations include time-sensitive networking, bounded latency, and automatic frequency coordination, making Wi-Fi much more attractive to mission-critical networking functions in the enterprise and industrial sectors. Vendors are investing massively in machine learning and AI to improve their Wi-Fi technology performance and create a differentiation layer to an increasingly standardized radio technology.

The cellular industry is still lobbying for the 6 GHz band, despite evidence suggesting that mobile network traffic growth is slowing – with Wi-Fi taking more of the total traffic load. Due to the improved capabilities of the Wi-Fi standards, and cellular drive into unlicensed spectrum, the two technologies are coming into contact in more ways than one – in both spectrum and use cases. To this end, convergence between the two camps is more important than ever, especially as private enterprise networks favor using both technologies to support highly innovative deployments. Wi-Fi is usually the best solution for indoor coverage and added capacity, while 5G is best for outdoor and wide-area networks. To such effect, the WBA has issued a detailed report on the importance of 5G and Wi-Fi convergence in deploying seamless, access-agnostic connectivity for enterprise organizations

<sup>1</sup> <https://www.wi-fi.org/news-events/newsroom/wi-fi-alliance-2022-wi-fi-trends> - 18 billion in 2022, with 4.4 billion shipping that year.

<sup>2</sup> [https://www.wi-fi.org/download.php?file=/sites/default/files/private/Global\\_Economic\\_Value\\_of\\_Wi-Fi\\_2021-2025\\_202109.pdf](https://www.wi-fi.org/download.php?file=/sites/default/files/private/Global_Economic_Value_of_Wi-Fi_2021-2025_202109.pdf)



## Notable Survey Results

The WBA's annual survey of Wi-Fi stakeholders is one of the sector's most important indicators of key technology adoption and monetization trends. This year, there were 196 respondents. Some 51.53% were from Americas, 30.10% from EMEA, and 18.37% from APAC. The key findings from the survey reflect the main themes of this year's report. These are diversifying business models and the technologies that enable these changes, specifically Wi-Fi 6E and the convergence of Wi-Fi and cellular.

The survey highlights include:

- 57.9% say they are more confident in investing in Wi-Fi than a year ago – up from 46% in last year's survey.
- 68% have deployed or plan to deploy Passpoint and/or OpenRoaming.
- Quality of Service (QoS) remains the primary motivator for Wi-Fi investments.
- The business model remains the most pressing challenge for new deployments.
- While 81.5% said they were involved in in-home Wi-Fi networking, 69.7% said they were already involved or planned to be involved in city-wide networks.
- 44.2% said 6 GHz spectrum availability was important, with 25.9% saying it was 'somewhat important – a total positive response of 70.1%, compared to the 8.9% that said its as not important.

## 2. Interview with WBA Chairman

### 2.1 Looking back over the past year, what are the most significant achievements of the WBA?

This year, the WBA celebrated our 20th anniversary! This occasion presents a fantastic opportunity to reflect upon the impact the WBA, together with our members, has made in the industry:

- In that time, the WBA has grown from its founding in 2003 by 5 operators, to an influential, growing trade association with over 200 members.
- The WBA has been, and continues to be, the driving force behind Wi-Fi roaming and interoperability - from those first few roaming trials in the early 2000's to the proliferation of, and support for, Passpoint and OpenRoaming today.
- The WBA has grown our sphere of influence by continued collaboration with industry bodies, including regulators and organizations like the GSMA, IEEE and the Wi-Fi Alliance.
- The momentum behind World Wi-Fi Day - a platform to recognize and celebrate the significant role Wi-Fi is playing in cities and communities around the world and understand how Wi-Fi is helping to bridge the digital divide - continues to grow each year.

### 2.2 What will be the biggest challenges for the WBA to address in the year ahead, and how will these be best met?

One of the biggest opportunities the WBA has is to help operator-managed Wi-Fi networks improve in-home Wi-Fi to ensure coverage and quality. Using Wi-Fi at home is one of the primary ways many of us interface with the internet, and unfortunately, due to a variety of factors, sometimes that experience is not a good one.

As the first step toward that effort, this year the WBA released a technical report outlining an operator-managed Wi-Fi (OMWi) reference architecture, proposing a framework combining multiple available standards to streamline Wi-Fi data collection, Wi-Fi management, configuration and optimization of home networks.

There is a myriad of operator-managed Wi-Fi solutions available that use different proprietary or standard methods for data collection, remote management, mesh formation, etc., making it extremely difficult for operators to provide a consistent level of service for their users. The WBA and its members are seeking to change that with a new reference architecture that combines the best standards into one, holistic, cost-effective solution.

This report was the WBA's first release on operator-managed Wi-Fi, and the WBA is planning on later phases that expand on these initial recommendations.

### 2.3 What are the most critical evolutions in Wi-Fi technology which will expand business opportunities in the next decade?

A couple of notable trends come to mind – enterprises increasingly adopting Wi-Fi 6E and the convergence of Private 5G and Wi-Fi. Wi-Fi 6E allows for much wider channels, which can minimize interference in densely populated areas such as apartment blocks or office suites where multiple Wi-Fi access points are competing. Wider channels also provide higher speeds and lower latency. Using the spectrum from 2.4, 5Ghz and 6Ghz provides more channels for different APs, thus helping to avoid interference. Wi-Fi 6E also allows for increased capacity. As more connected devices are introduced into homes and offices, it's important that these devices can be supported without slowing down performance or impacting the quality of experience for other users. Wi-Fi 6E will be critical for use cases such as video conferencing, video streaming, gaming, augmented reality and virtual reality applications.

A study from Deloitte in 2022 found that 96% of enterprises plan to use Wi-Fi and 5G in their connectivity mix. Converging Wi-Fi 6E and 5G can provide greater network resilience, allowing users to stay connected even in areas with poor coverage or signal interference. The stated goal of this convergence is to realize an access agnostic service layer that enables policies to be enforced for an enterprise user/device across both Wi-Fi and 5G access.

One of the technologies that will help enable this convergence is Access Traffic Steering, Switching and Splitting (ATSSS). ATSSS allows a device connected to a core network over both 3GPP and non-3GPP access to perform traffic steering across both of the access connections. A key benefit of ATSSS is enhancing the user experience by securing connectivity through times of congestion, as well as transitions between indoor and outdoor environments. When one of the connections fail, ATSSS enables connectivity between the two bearers and uses their capabilities interchangeably without manual intervention or a sluggish response.

## **2.4 What is your assessment of the progress made by OpenRoaming™ so far?**

OpenRoaming continues to make great progress. OpenRoaming passed the 1 million hotspots mark last year and continues to see adoption by a variety of venue types including stadiums, healthcare facilities, transport hubs, hotels, and more. Late last year, OpenRoaming was adopted by one of Europe's largest exhibition facilities, RAI Amsterdam, enabling delegates, exhibitors and attendees to connect seamlessly and securely to Wi-Fi.

One of the benefits that makes Passpoint, and by extension OpenRoaming, so attractive is the increase in Wi-Fi connections. We've seen venue attach rates increase more than 10x with OpenRoaming adoption which means more users connecting seamlessly and securely with an improved customer experience.

## **2.5 How is WBA helping AT&T to support and develop its mobility business, including Wi-Fi Offload and Wi-Fi Roaming especially considering the launch of OpenRoaming™?**

All of AT&T's Wi-Fi roaming agreements are predicated on using Passpoint, one of the key components of OpenRoaming, as the method of authentication – because the connection is automatic, and the information exchanged by the device and the network necessary to authenticate the customer is encrypted. We continue to see an increasing number of venues – in the US and abroad - adopt Passpoint and OpenRoaming. Additionally, as Wi-Fi networks continue to evolve, notably with Wi-Fi 6, 6E and 7, this is changing the in-building wireless dynamics by making Wi-Fi a practical, lower cost solution to solve in-building coverage.

## **2.6 Finally, when we write the 2025 industry report, what do you hope the WBA and the wider Wi-Fi community will have achieved the most?**

Definitely continued growth of Passpoint Wi-Fi and OpenRoaming, along with wider adoption of Wi-Fi 6E, Wi-Fi 7 and convergence technologies such as ATSSS. I would like to see the WBA continue to lead the adoption of standard QoS metrics across Wi-Fi networks and manufacturers, which I believe is key to driving toward a better, more predictable, Wi-Fi customer experience.

As always, my vision is that we have a robust, growing, and active organization that continues to add value to our membership by delivering projects that equip them to drive significant business results.

### 3. Interview with Tiago Rodrigues, President and Chief Executive Officer at the WBA

The Wi-Fi Industry continues to enjoy substantial growth- what are the key drivers and enablers behind this?

Wi-Fi continues to be the most widely used wireless broadband technology globally. To that end, I see eight main drivers that are relevant for Wi-Fi to continue its upward trend and benefit from ongoing growth in terms of traffic figures, as well as sales of Wi-Fi equipment:

**Acceleration of digitalization across industries and services:** Whether you're a large multinational company, a small local business, or a start-up, a robust digital strategy is a must have. The increasing growth of start-up businesses based on digital platforms must also be addressed as consumers and professionals are connected for longer periods of time and more activities.

**Workforce dynamics:** While this can be applied to the work-from-home trend brought on by COVID-19, it can also be applied to the increase of digital nomads and decentralized professionals that can work from anywhere.

**Education transformation:** The evolution of education at all levels with a bigger emphasis on digital content is accelerating dramatically, allowing younger generations to stay connected for multiple reasons related to education.

**Entertainment revolution:** In recent years, the way in which we communicate and entertain with friends and family has evolved drastically via messaging, social media and streaming platforms, with people of all ages using these communication methods on a daily basis.

**Online Shopping:** Each passing year brings more and more digital marketplaces into our daily lives. The ability to buy virtually anything online, as well as the ability to extensively research products before making a decision, shows how important staying connected is.

**Digital Divide:** Wi-Fi is the most universal wireless broadband connectivity technology, and it can be deployed in remote areas and underserved communities as the primary option to connect to Internet - not only because of its availability in all devices, but also due to its relatively low cost.

**Wi-Fi technological advances:** Wi-Fi has had several fundamental innovations as a technology, including the standards of Wi-Fi 6, Wi-Fi 6E, the soon-to-be-here Wi-Fi 7, and additional spectrum being made available in many countries using the 6Ghz band. It's also seen specific innovations to particular market segments like Mesh Wi-Fi solutions for residential Wi-Fi or OpenRoaming for Guest Wi-Fi.

One final factor that I believe is important is related to broadband evolution, like fiber, FWA, satellite and other technologies, as the increase of capacity of Service Providers make the perfect marriage with Wi-Fi technology to provide an improved user experience and benefit from the 7 previous factors I mentioned.

#### 3.1 What are the most exciting programs the WBA is working on?

There are several interesting projects currently in progress and being undertaken by the members of WBA, a few of which I'll outline here.

OpenRoaming has been playing a key role on the activities of the Alliance, not only due to the growing number of global deployments but also by the large scope OpenRoaming is addressing in verticals such as Guest Wi-Fi, IoT, Private Cellular and more.

WBA's Operator Managed Wi-Fi Program for In-Home is another exciting initiative, where members are defining the best practices for residential architectures and creating a roadmap of evolution that broadband service providers can rely upon and follow.

“Get Ready for Wi-Fi 7,” a deliverable from WBA’s Wi-Fi 7 project team, has been very popular among members who can utilize it as a tool to educate and clearly illustrate the benefits of and use cases that Wi-Fi 7 can play a key role in.

Lastly, Wi-Fi HaLow and Sustainability are new programs in WBA that generated a lot of interest from our members, and we invite all companies who are interested in these topics to come together.

### **3.2 What can you tell us about the momentum the WBA is currently enjoying?**

Last year, I predicted that WBA would reach the 200-member mark by mid-2023, and I’m very proud to confirm that number was accomplished, and moving forward WBA will continue to grow its membership and activities. It gives me great pleasure to say that this is the best and most successful period for the WBA since our formation 20 years ago.

In fact, 2023 is the year of multiple WBA records, not only are we celebrating the 20th Anniversary but also the number of members participating in our programs and projects reaching never-before-seen levels this year. Our organization is continuing to bring companies and organizations together from across the Wi-Fi industry and helping our members solve wide-reaching challenges while also accelerating valuable business opportunities.

In addition, WBA is now a legal entity in the United States, which is where the majority of our members are based. This move made WBA more efficient in how we can serve our members and accelerated new opportunities for our organization as a whole.

### **3.3 What do the next 18 months hold for the OpenRoaming federation?**

I feel very confident in stating that OpenRoaming will continue to evolve exponentially over the next 18 months, and beyond. With over 3.5 million access points already live, more than 600+ companies are currently involved in OpenRoaming deployments.

We continue to see increased interest in OpenRoaming not only from the members of WBA, but also from organizations that deploy Guest Wi-Fi networks, including municipalities, enterprises, retailers, and carriers, among others.

I predict that OpenRoaming’s growth will lead to thirty million (30,000,000) access points being available globally within the next 2-3 years. WBA OpenRoaming is fundamental to changing the way we connect to Public-Guest Wi-Fi by making it seamless, easy, and secure while respecting the privacy of the users. Today’s reality is often very fragmented and confusing, and it’s time for the Wi-Fi industry to come together and solve these issues using WBA OpenRoaming.

### **3.4 Sustainability is becoming increasingly crucial in Wi-Fi networks; what can you tell us about sustainability progress?**

Sustainability is a critical topic today around the world, and Wi-Fi technology in particular plays a key role. As the most used wireless broadband technology in the world, Wi-Fi must lead the sustainability strategy, not only to be a more energy-efficient technology but also an enabler in making our houses, offices, public spaces more energy efficient.

Recently, WBA created a Sustainability task-group in partnership with GeSI (Global Enabling Sustainability Initiative) and became part of the EGDC (European Green Digital Coalition). The task-group’s work is already underway, and participation and involvement of members has been very positive.

### **3.5 Tell us about World Wi-Fi Day.**

World Wi-Fi Day is a global and symbolic initiative WBA started eight years ago with the goal to raise awareness of the role of Wi-Fi in connecting the unconnected and the benefits that it provides in bridging the digital divide. WBA's main goal for World Wi-Fi Day is to mobilize the Wi-Fi community and everyone that benefits from internet access via Wi-Fi, giving them a day to celebrate and share their accomplishments and stories. I invite everyone in the world of Wi-Fi to join forces and celebrate it every day, but in particular on June 20th every year.

### **3.6 What would you say to those not yet familiar with the work of the WBA?**

WBA's membership includes 6 out of the 10 largest operators and 7 out of the 10 largest technology providers in the world, which I believe says a lot about our organization and the importance of becoming a member. These companies are collaborating under the WBA banner with an overall goal of making Wi-Fi better and more accessible for every home, enterprise, business and city in the world, and we look forward to playing a key role within the industry for years to come. If you're not a member of the WBA, I strongly suggest that you consider it – our membership continues to grow year after year, and many of your partners, suppliers, customers and competitors have already joined. We would be honored to have you on board as a WBA member!

## 4. Key Market Segments and the Impact of Wi-Fi

### 4.1 Residential Wi-Fi

Home users are connecting to broadband like never before and, on average, own nearly 20 connected devices in their residences. Residential broadband usage continues to grow across applications and connected devices, with video streaming representing the lion’s share of traffic origination. The proportion of power users (1>TB) now represents 16 percent of all users, according to 2Q2023 data from OpenVault. The average bandwidth usage across U.S. broadband households is now a staggering 533.8 GB, up from 513.8 GB in 2Q2022. As we reported in the previous edition of this report, Wi-Fi 6/6E client devices are also entering the home at an unprecedented rate, surpassing 50 percent market share since these devices were introduced in 2019 (compared with four years for Wi-Fi 5 to have the same penetration). IDC reports that 473 million 6GHz devices will enter the market in 2023—nearly 20 percent of all Wi-Fi 6 shipments — and will grow to 1.1 billion in 2025. Power users are becoming the norm as premium gateways enter the market. These users will be the early adopters of Wi-Fi 7 in 2024.

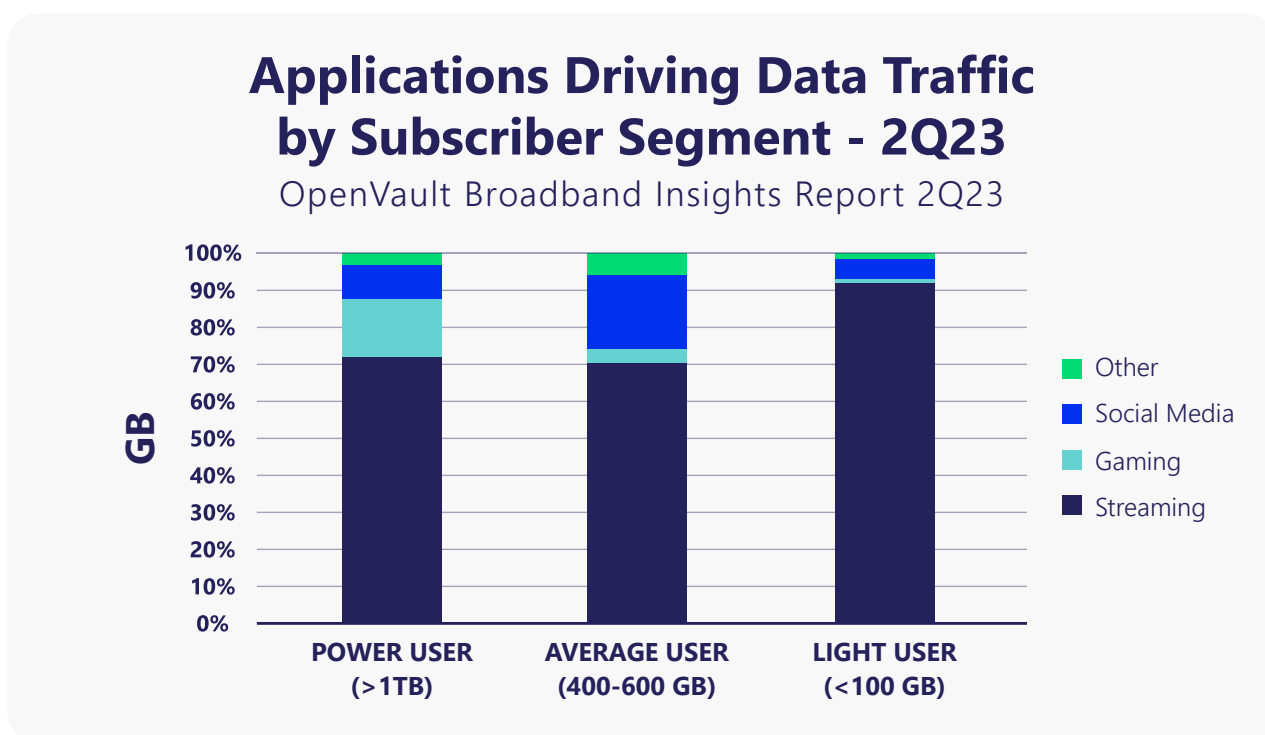

Figure 1: Applications Driving Data Traffic by Subscriber Segment 2Q2023.

As digital immersion is expected to revolutionize the home online experience, Wi-Fi speeds and latency will be stretched to the limit. Remote rendering requires significant capacity and sub 5ms latencies that will only be possible with the most efficient spectrum usage and scheduling techniques provided by Wi-Fi 6/6E, and even 7. We discuss the implications of the metaverse at length in Section 6.

As a result of these trends, service providers are under pressure to provide managed Wi-Fi to their residential customers with Wi-Fi guarantees down to the device. Users no longer differentiate between Wi-Fi and Internet service, expecting their Wi-Fi issues to be resolved by their Internet service provider (ISP). The expectation shift has turned Wi-Fi into a managed service — managed explicitly by the operator — hence the term “operator managed.”

To help service providers sort through the many standards and technologies available, the Wireless Broadband Alliance (WBA) released a technical paper, Operator Managed Wi-Fi: Reference Architecture and Requirements, which outlines new operator-managed Wi-Fi (OMWi) reference architecture. The proposed framework will combine multiple standards to streamline Wi-Fi data collection, management, configuration, and optimization of home networks, simplifying the analysis and decision-making process for carriers.

ISPs' ability to monitor and optimize their customer's quality of experience results in fewer service calls and truck rolls, resulting in lower operating expenditures and churn rates. To help ISPs optimize their Quality-of-Service (QoS) mechanisms, the WBA published a new white paper, "E2E QoS Improvement, Optimizing QoS Over Wi-Fi Links". The paper identifies typical performance issues for representative use cases and recommends mechanisms and standards to achieve set Key Performance Indices.

A discussion of residential Wi-Fi would not be complete without a mention of the Matter application standard. The massive growth of the smart home market has led to problems with competing standards and protocols. Matter is a smart home application layer standard that solves proprietary solutions' interoperability and security problems—more on Matter in section 5.

## 4.2 Enterprise Wi-Fi

Enterprises are continuing their digital transformation journey, which requires network transformation. The network is the foundational layer for enabling secure, scalable, and efficient use of Cloud, Edge and IoT Applications. This means enterprises will continue to adopt new technologies to remain competitive.

Among the network investment priorities, automation, and remote management top the list of enterprise networking professionals, followed by security and visibility/analytics. Wi-Fi plays an important role in all these aspects.

Artificial intelligence (AI) is now an essential tool for network automation and for managing enterprise Wi-Fi networks. WBA member Boingo Wireless explained during the 2023 [Wireless Global Congress](#) that AI is an essential tool to ensure optimal network performance. Sixty percent of networking professionals spend one day per week on nothing but Wi-Fi troubleshooting. Fifteen percent of engineers spend over half of their time troubleshooting Wi-Fi issues. Because in over 52 percent of cases it takes more than an hour to isolate the problem, AI and machine learning can improve network performance and staff productivity.

Since the COVID-19 pandemic, the rapid shift to cloud services and the complexity of dealing with a hybrid workforce have changed how modern IT and networking leaders ensure their businesses can cope with the demands of the modern workspace. Enterprises are progressively becoming hybrid environments with nomadic employees carrying many devices over Wi-Fi and cellular networks. The interworking and coexistence of Wi-Fi with cellular is increasingly essential. The WBA published Private 5G and Wi-Fi Convergence: Key Use Cases and Requirements, which outlines the critical role new and existing Wi-Fi infrastructure has yet to play in maximizing the potential of 5G. Organizations can move to fully converged platforms that offer broad, frictionless coverage and effortless user onboarding.

Another significant trend in the enterprise is the emergence of the network as a service (NaaS), where enterprises outsource the ownership and operation of their networks to third parties, which are usually managed service providers. Given the rise in network complexity, the pace of change in security threats and the lack of IT staff, enterprises have trouble keeping up with the requirements to keep their networks safe and running. As a result, the enterprise increasingly prefers to pay for an MSP to manage their networks as a service.

<sup>3</sup> <https://wballiance.com/wi-fi-and-existing-network-functions-critical-to-private-enterprise-5g-deployments/>



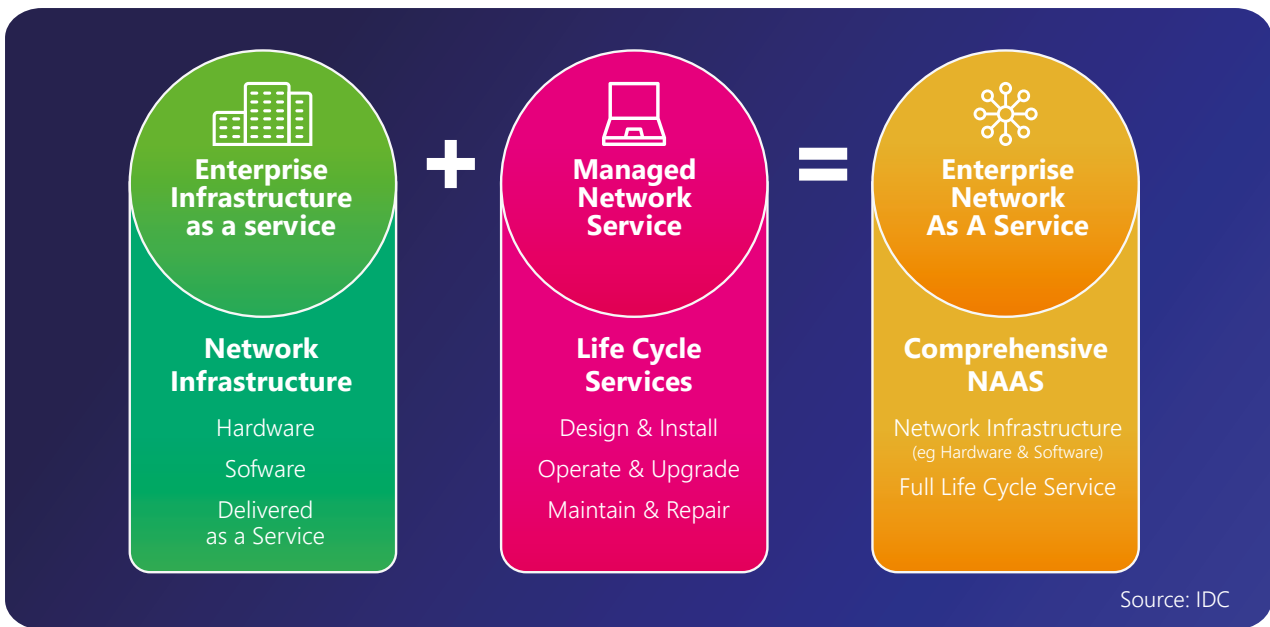

Figure 2: Enterprise NaaS, Enterprise Infrastructure as A Service, and Managed Services

Let us now look at specific enterprise market segments, starting with hospitality.

### 4.2.1 Hospitality

The hospitality sector has fully recovered from the pandemic, and hotels are busier than ever.

Hospitality is keen on reducing friction as much as possible, given how important excellent Wi-Fi is among guests. Guests typically bring two or three devices each when they stay at these hotel properties, and quality Wi-Fi ranks as one of the most important to guests when selecting a hotel. As shown in Figure 2, most guests expect their connectivity speed to be higher than 50 Mbps.

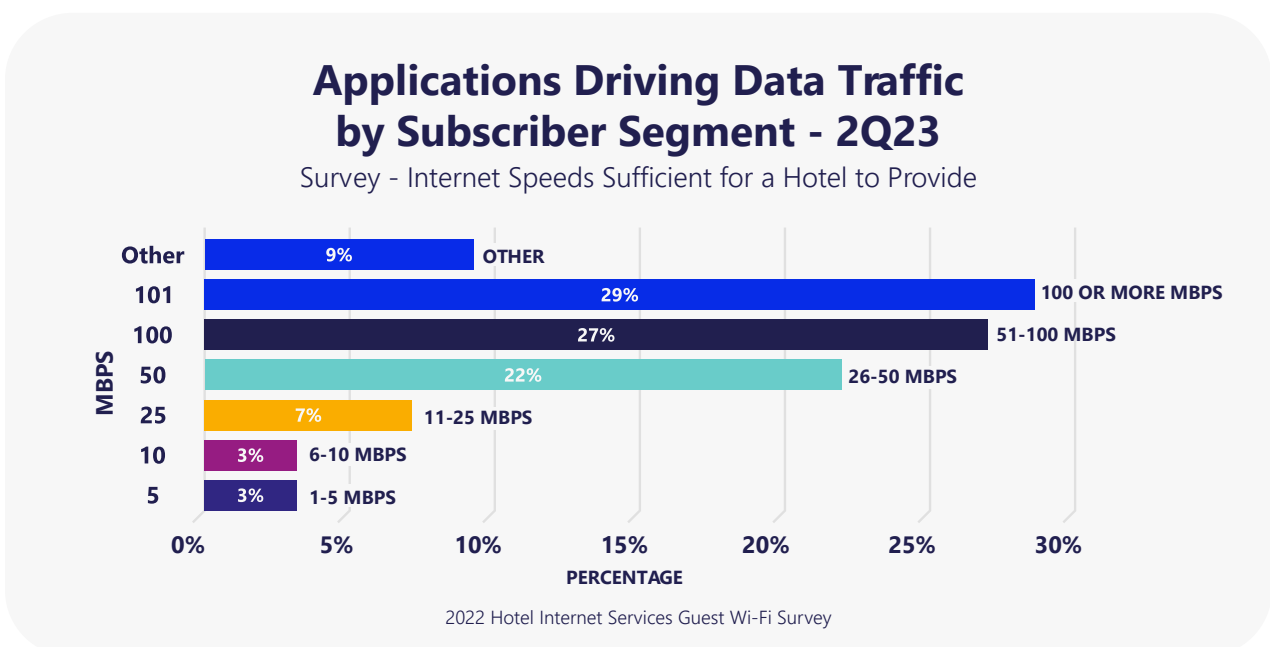

Figure 3: Applications Driving Data Traffic by Subscriber Segment - 2Q23

<sup>4</sup> <https://wballiance.com/resource/delhaize-delivers-wi-fi-excellence-in-retail-with-openroaming/>

Passpoint and OpenRoaming can further help hotels improve seamless and secure connectivity. Great Wi-Fi is also critical for staff members to be able to do their work and for property owners to increase operational efficiency. Hotels are also a great example of where cellular and Wi-Fi can coexist while serving distinct requirements regarding latency, coverage, security, and bandwidth.

### **4.2.2 Stadia and Conference Venues**

Shows and in-person conferences have returned to pre-pandemic levels. Networks in these dense venues can rapidly become congested if the capacity is poorly planned, especially as more people are uploading large video files as they engage with the overall stadia experience.

Stadia and conference venues showcase the benefits of using the latest Wi-Fi 6 and 6E generation in performance thanks to great radio frequency (RF) performance and wider channels. Easy onboarding is also important in these public environments. OpenRoaming was showcased at the WBA Wireless Global Congress (WGC) Americas in Chicago and Las Vegas GSMA Mobile World Congress in Barcelona; at the RAI Amsterdam with Cisco Live and WGC EMEA, to demonstrate how venues can join the Wi-Fi federation and enable a better Wi-Fi experience for guests.

### **4.2.3 Retail (Including Coffee Shops and F&B)**

Retailers increasingly use technology to provide shoppers with a brick-and-mortar experience that resembles the online shopping journey. Wi-Fi technology enables shoppers to use their mobile devices to compare prices, research products, access social media, enjoy timely discounts, and more. Retailers must evaluate their captive portal strategies and analytics tools to maximize their engagement and generate more revenue.

Logging on to public Wi-Fi in a coffee shop or store using a captive portal can lead to a poor experience if the captive portal fails to load. The experience is also far from smooth if users want to return to the login page later, find the website to reaccept T&Cs, backtrack, and find the venue's original portal page to check data allowance or change services.

Ahold Delhaize, a Belgian retail company operating supermarket chains in Belgium and Luxemburg implemented OpenRoaming technology to provide a better shopping experience for their customers by simplifying Wi-Fi network access across multiple networks.

OpenRoaming helps smooth onboarding while enabling retailers, coffee shops, and restaurants to engage with their customers securely—thanks to Cappid API. This new captive portal API gives Wi-Fi access points a reliable way to “advertise” themselves as captive portals, making it easier for users to find information, including their session and venue information, and to maintain a connection with the service provider or brand. Cappid API is based on IETF specifications that describe how these networks should be set up to be identified.

The implementation of OpenRoaming by Delhaize has resulted in a more convenient and seamless shopping experience for their customers. Additionally, the data collected through this technology provides valuable insights into customer behaviour and preferences, allowing Delhaize to improve their services, operations and customer loyalty. This exemplifies Delhaize's dedication to providing innovative solutions that enhance the customer experience in their retail stores. WBA has a project on Venue requirements for OpenRoaming/Passpoint – good to mention here.

### **4.2.4 Aviation (Airlines, Airports, and Supporting Infrastructure)**

Airports and planes are more congested than pre-pandemic levels. As a recent CNBC documentary highlighted, passengers often experience poor Wi-Fi connectivity in planes. Passengers can experience difficulties in onboarding or face low speeds and a lack of coverage. There are several reasons for these problems, including limited satellite backhaul capacity, an increasing number of passengers streaming video simultaneously, and spotty geographical coverage in large areas of the globe.

Passpoint solves the onboarding aspect of the problem. Identity providers can offer pre-provisioned Wi-Fi access or promote airline app adoption thanks to passenger identification. While not yet the case, a standard Roaming Consortium Organization Identifier (RCOI) across all airlines would be an ideal objective to move the industry forward. Mobile network operators (MNOs) can also pay for access to in-flight Wi-Fi for their customers. The WBA presents the new business models made possible for the various stakeholders in its latest In-Flight Wi-Fi report.

Airports are also complex network environments where multiple radio technologies are normally used: DAS, Wi-Fi, private 5G and proprietary legacy networks to support distinct use cases and population and things. These networks are currently co-existing in isolation from each other which leads to more complex network management and higher operational costs. Airports are thus primary candidates for network convergence trials and early adoption with security assurance in top mind. The WBA Private 5G & Wi-Fi Convergence team has dedicated this year to engaging in discussions and advancing core technical elements.

#### **4.2.5 Ground Transportation**

Urban mass transit systems have greatly increased in recent decades as the world's population has rapidly urbanized. Mass transit contributes to the density and clustering that drives innovation and productivity, extending the boundaries of cities' metro areas while creating opportunities for denser development around suburban stops. According to the International Association of Public Transport, mass transit carried over 54 billion passengers in 2022.

Connecting these massive numbers of commuters and travelers can impact quality of life and productivity. It is also challenging to assemble all the pieces required from the infrastructure to access rights and funding for such CAPEX-intensive projects. This can only happen if partnerships involving transport utilities, cities, and communication service providers work together to deploy the infrastructure and find ways to monetize those investments. Wi-Fi is a primary radio technology for these deployments, both for underground mass transport and buses where cellular networks can backhaul the traffic. OpenRoaming is designed to dramatically simplify how passengers and staff connect to the network, with no lengthy and repetitive sign-up or connection process required. From carriage to platform to subway and beyond, connecting to the network happens securely without any further actions from the user.

The ['Moving Networks'](#) program within WBA is expanding its reach to encompass maritime, bus, and vehicular transportation. The challenges are similar across these diverse sectors, the demand for uninterrupted connectivity, the imperative to prevent disruptions, the requirement for high-quality signals, and the necessity for efficient roaming options persist.

#### **4.2.6 Smart Transportation and Connected Vehicles**

Intelligent transportation and connected vehicles are also seeing significant developments. Use cases range from cars acting as hotspots and including seamless convergence with 5G at vehicle speeds to enabling the phone as a car key. Electronic controller units could be connected wirelessly inside the vehicle, significantly impacting fuel efficiency, given that cables represent 60 percent of a vehicle's mass, according to various car manufacturers. Wi-Fi is used by car manufacturers to gather engine and performance data and provide service messages and over the air upgrades - driving resource efficiencies. The same can be said for transportation and other moving vehicles. OpenRoaming also offers possibilities for electric vehicle charging stations as well as seamless onboarding.

<sup>5</sup> <https://youtu.be/qtjnFwfgMv8>

<sup>6</sup> <https://wballiance.com/in-flight-wi-fi-connectivity/>

<sup>7</sup> <https://wballiance.com/latest-wba-report-sets-out-how-wi-fi-6-6e-enables-industry-4-0/>

## 4.2.7 Industrial and Manufacturing

Increasingly, private wireless networks require a solution that hides the complexity from the IT/OT organization, using machine learning to solve anomalies and automate complex decisions. Enterprises need network visibility and service assurance while leveraging the cloud to scale. Policy engines can help manage access across multiple radio access networks (RANs), giving the enterprise complete control of who can access its network and manage their profiles and guaranteeing security and quality of service.

Wi-Fi 6/6E combined with Multi-access Edge Computing (MEC) and machine learning bring capabilities suitable for manufacturing and industrial environments. Wi-Fi 6/6E and soon Wi-Fi 7 provide many deterministic Quality of Service (QoS) capabilities, such as traffic prioritization, a key component of Time-Sensitive Networking (TSN) for Industry 4.0 applications. Intel and Cisco are collaborating to enable TSN applications like remote control of robotics for manufacturing in Wi-Fi 6 networks, especially for applications that rely on the new deterministic/bounded (<2ms) of Wi-Fi 6-TSN.

Augmented/virtual/mixed reality is an essential emerging application in manufacturing and industrial environments requiring Wi-Fi networks that guarantee bounded latency.

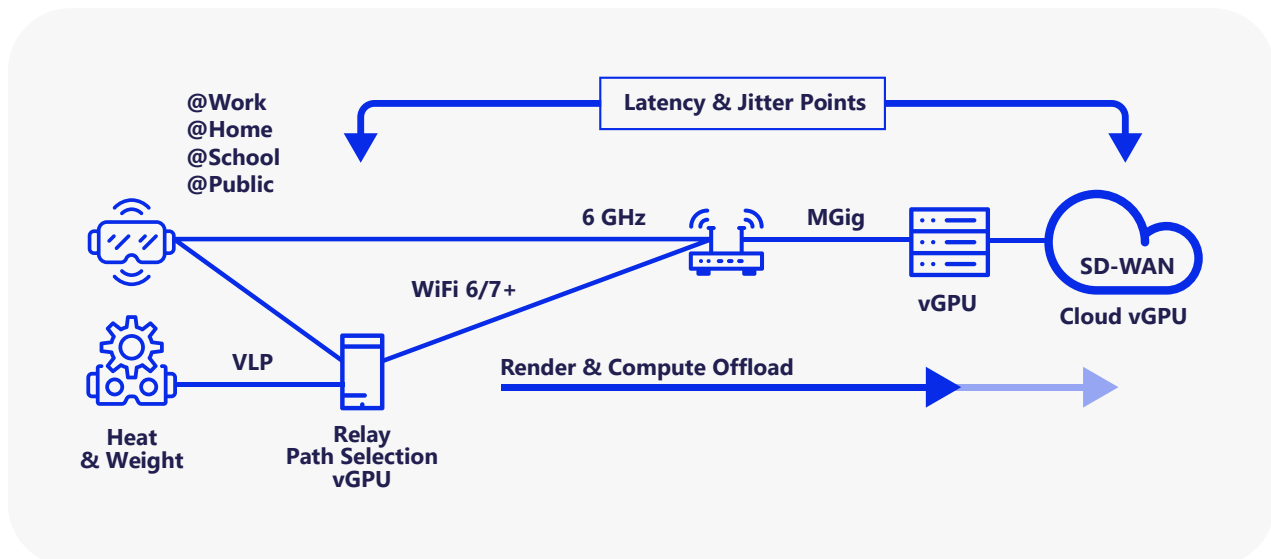

Figure 4: Industrial and Manufacturing

The WBA published [“Wi-Fi 6/6E /6E for Industrial IoT: Enabling Wi-Fi Determinism in an IoT World,”](#) which explores how Wi-Fi’s latest features are ideal for meeting the unique, demanding requirements of various existing and emerging IoT applications. This includes manufacturing/Industry 4.0 and logistics involving autonomous mobile robots (AMRs), automated ground vehicles (AGVs), and predictive maintenance.

AMR and AVG platforms are used in factories, warehouses, and logistics businesses to carry and deliver parts, products, and materials from a variety of sources and destinations be it inside a building or outside on a loading dock. AMRs are robots built with the capability to autonomously move and perform tasks. Both types of robots are increasingly equipped with onboard sensors (radar, lidar, optical, etc.) to detect the platform’s environment in real-time and using actuators (arms, conveyor, etc.) to assist in moving materials to/from the platform itself. In addition, some platforms may also have explicit onboard location/positioning technology based on either the Wi-Fi network, UWB or even outdoor GPS network. These moving robots require latency below 20 ms, jitter below 1ms, throughput over 10 Mbps and five 9s reliability.

<sup>8</sup> Operational team (OT)

<sup>9</sup> Industrial IOT

## 4.2.8 Education

The education sector remains one of the fastest-growing sectors regarding Wi-Fi deployments. As a result of the pandemic, many governments have decided to fund large-scale deployments of Wi-Fi networks in schools and distribute PCs and tablets to facilitate distance learning and new ways to educate. Wi-Fi solutions enable more dynamic educational experiences and new applications to immerse and inspire along with the ability to help bridge the digital divide between kids. Immersive AR/VR experiences are emerging to enable more dynamic learning—students and teachers can move freely around their classroom or campus through peer-to-peer connections or multiple access point (AP) systems, ensuring that everyone is engaged and connected even outside the classroom. The key to delivering this vision is excellent network connectivity (Wi-Fi 6E and Wi-Fi 7) and the Wi-Fi 6E/7 end-user devices and equipment.

## 4.2.9 Healthcare

Healthcare can use Wi-Fi to improve patients' health outcomes and overall experience while in the facility. With the right platform, hospitals can create a customized Wi-Fi experience for each type of user including medical staff, nonmedical staff, patients, and visitors, each with a level of access rights, security, bandwidth consumption, and relevant features. Cisco reported impressive 2–4x increases in attach rate in a healthcare deployment of OpenRoaming. Hospital visitors enjoyed a great experience which resulted in reduced visitor coverage complaints. The clinical staff's productivity increased while the IT staff saw less burden to troubleshoot the Wi-Fi network.

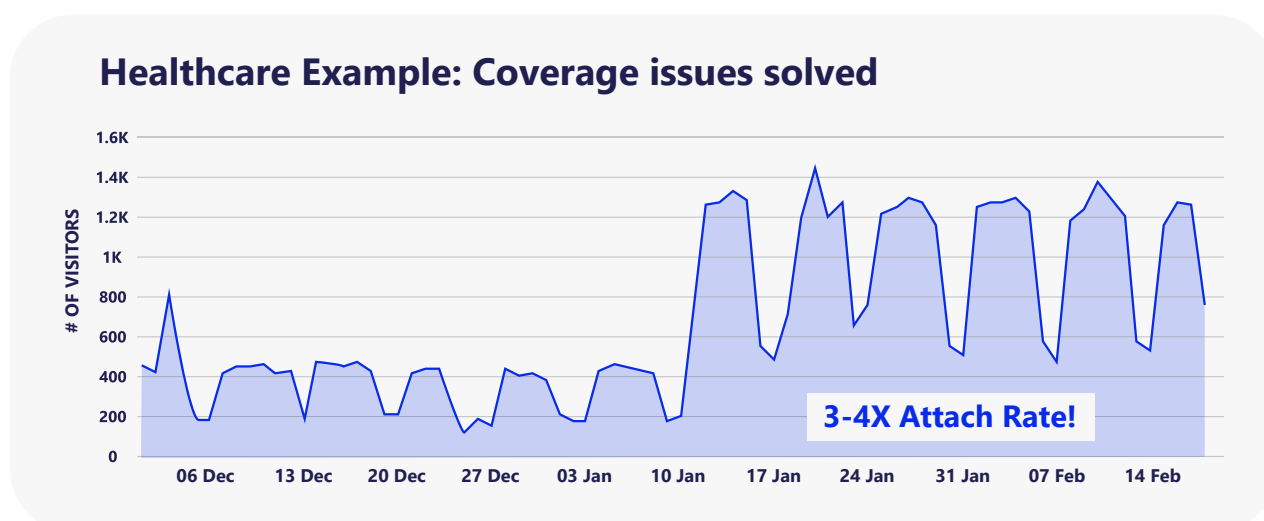

Figure 5: Healthcare OpenRoaming Results

Source: Cisco

Such tiered access can help hospitals generate new revenue streams and improve patient and visitor experience.

Another important trend is the move to home healthcare for patient consultations, support and monitoring. The remarkable growth of the remote healthcare market can be largely attributed to the increasing adoption of telemedicine and virtual health services. Telemedicine has revolutionized the way doctors and healthcare professionals interact with patients by allowing them to remotely diagnose and treat individuals using video conferencing and other virtual tools. The advent of this technology has become particularly crucial during the COVID-19 pandemic, as it enables healthcare providers to deliver essential care to patients while minimizing the risk of virus transmission.

One of the key advantages of telemedicine is its convenience and accessibility, making it an appealing option for patients, especially those with limited access to traditional healthcare services. The ability to receive medical

<sup>10</sup> <https://wballiance.com/latest-wba-report-sets-out-how-wi-fi-6-6e-enables-industry-4-0/>

attention from the comfort of their homes has proven to be highly attractive to patients, enhancing patient engagement and overall satisfaction provided the Wi-Fi network is performing well...

### 4.2.10 Multi-Dwelling Units

Multifamily rental demand is undergoing a multigenerational transformation in most developed countries. As the population grows and younger generations enter the renter market, reliable Wi-Fi is at the center of expectations and needs. This transformation is happening in the context of the rapid adoption of smart home devices and permanent hybrid work models. Maravedis predicts the managed Wi-Fi market will grow to over \$6 billion in service revenues in the U.S. by 2028. We expect other regions, such as Asia, Europe, and Latin America, to follow suit, starting with luxury condominium units and followed by more conventional rental units. Interestingly, in early adopter markets like the U.S., managed Wi-Fi is also seeing traction in affordable units as government programs fund connectivity for underserved communities. Other notable segments include student housing and senior living, which are becoming increasingly significant as the population ages.

	LESS THAN 5 YEARS OLD	MORE THAN 5 YEARS OLD
MORE THAN 100 UNITS	Great Candidate	Good Candidate
LESS THAN 100 UNITS	Average Candidate	Weak Candidate

Figure 6: Managed Wi-Fi MDU Deployment Matrix

Source: Maravedis LLC

## 4.3 Connected Cities and Public Spaces

Cities are becoming more connected and smarter, one use case at a time from waste management to smart traffic lights. The following are some of the most dynamic use cases which require great connectivity.

### Public Safety & Security

Connected cities are embracing enhanced safety measures, empowering law enforcement to respond to crimes and emergencies faster and ensuring the well-being of residents. They now use surveillance systems in place, which can use a combination of IoT sensors, cameras, and other devices to help spot suspicious behavior early and in real-time. Traffic generated by these video feeds use both Wi-Fi and wireline technologies.

### Waste management

In every city, the persistent issue of waste poses significant challenges. As a result, waste management emerges as one of the most crucial smart city trends. For instance, connected cities use sensors to monitor waste disposal levels and analyze ways of minimizing them and residents are notified of their consumption. Cities are also using IoT sensors to monitor environmental parameters near waste disposal facilities, such as air quality, noise levels, and water pollution. This can help cities detect potential environmental hazards and mitigate them early on.

### e-Government

Residents are increasingly expecting more efficiency from their local governments in par with services offered

<sup>11</sup><https://www.einpresswire.com/article/644080170/managed-Wi-Fi-for-multi-dwelling-rental-units-ready-for-prime-time>

by the private sector.

Las Vegas is an excellent example of a city that uses technology to support its primary offering: entertainment. The city entertainment players connect many assets from large outdoor displays to indoor slot machines. Las Vegas also runs the largest Citizens Broadband Radio Service (CBRS) network in the U.S., showcasing network coexistence between cellular and Wi-Fi. In the future, Las Vegas wants to establish an innovation center where more than 20 companies incubate new ideas to improve city services, such as public safety, education, health, and mobility, with autonomous vehicles, robots, and drones.

The deployment of OpenRoaming by the Tokyo metropolitan government is another example of how Wi-Fi can be successfully applied to enable smart transportation and government services. Initially launched in 26 locations in March 2023, the network aims to provide free Wi-Fi to tourists and residents in select public areas soon to encompass 600 locations, including metropolitan high schools, facilities, smart poles, government offices, and more.

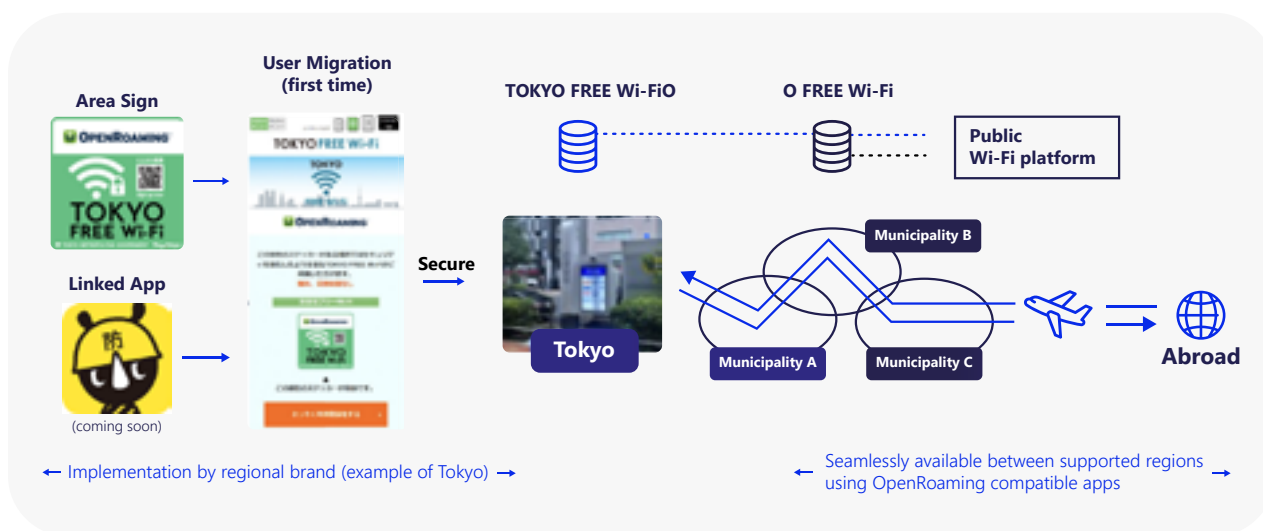

Figure 7: OpenRoaming/ CityRoam

We rarely see discussions about connectivity in parks and other remote outdoor areas. Yet outdoor hospitality operators serve 1.3 billion annual visitors across 400 national parks and 13,000 private recreational vehicle (RV) parks in the US alone. Access Parks presented some exciting deployment examples using all the technologies available to provide quality Wi-Fi to campers, from microwave to fiber Gigabit Passive Optical Network (GPON) to private cellular and Wi-Fi 6 with Passpoint enabled.

## 4.4 Rural Wi-Fi

A significant portion of the global population is still not connected to the internet, and in some regions of the world, the number of unconnected people skews towards higher percentages. In its 2022 report, *Measuring Digital Development Facts and Figures*, the International Telecommunication Union (ITU) revealed that internet use in rural areas is slowly catching up with urban areas with variations by region.

The urban-rural gap has been essentially bridged in Europe (ratio of 1.1). Elsewhere, it is wide but getting narrower. For instance, in Africa, 64 per cent of urban dwellers use the Internet in 2022 compared with 23 per cent of people in rural areas, a ratio of 2.8; but that is down from nearly 4 in 2019. In the Asia-Pacific region, the ratio is 1.8, down from 2.4 three years ago.

<sup>12</sup> <https://wballiance.com/kddi-and-wire-wireless-announce-a-public-wi-fi-infrastructure-supporting-openroaming/>

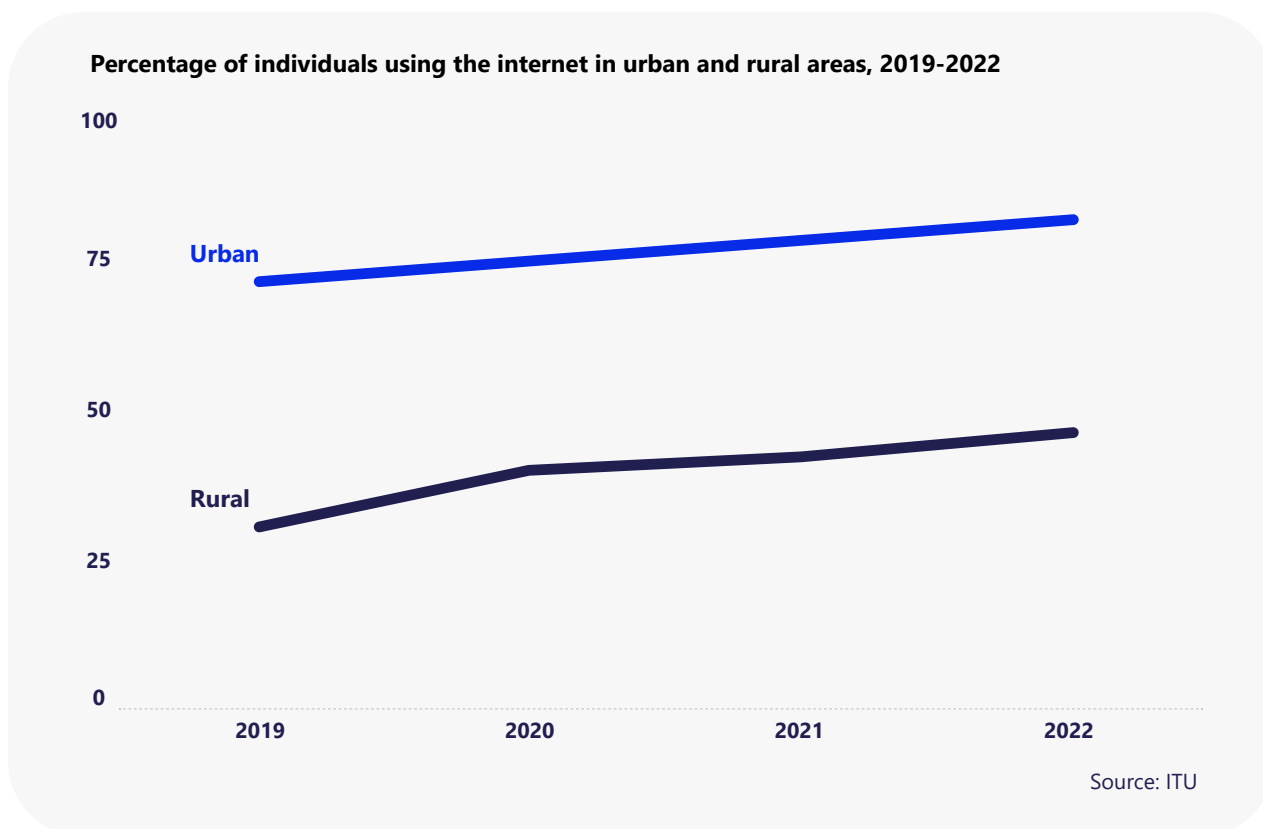

Figure 8: Percentage of individuals using the internet in urban and rural areas 2019-2022

There are various reasons why these rural regions have a high percentage of unconnected people; those reasons range from political to economic to social. The lack of computer literacy and PC ownership are essential causes, even if many people access the internet from a handheld device.

In its recent report, [Rural Wi-Fi Connectivity: Challenges, Use Cases and Case Studies](#), the WBA demonstrates why Wi-Fi is the most economical and practical technology for bridging the digital divide in small towns, remote communities, and other sparsely populated areas by using the best available backhaul solution.

The report also provides regulators with guidance on how Wi-Fi can bridge the digital divide in rural areas. A prime example is ensuring that the new 6GHz band is available in their countries, giving service providers additional spectrum to support more users and deliver the requisite speeds and performance.

The Connected Communities Forum (CCF) part of the WBA, develops, shares and promotes thought-leadership, providing a practical framework for social and economic development and sustainable operation of Wi-Fi networks in the Connected City ecosystem.

It is worth mentioning the work done by WBA Members, Cambium and SES to support “Centros Digitales” the biggest rural connectivity project in Colombia. The deployment covers 7,468 points of presence in schools, and municipalities (to reach 14,057) in 32 states. 15,000 Cambium outdoor Access Points (AP’s) and over 7,500 Indoor AP’s were deployed to provide last-mile broadband connectivity, a life-changing addition to local communities.

SES, a global satellite connectivity provider with over 70 satellites in two different orbits, also connects isolated communities or disastrous zones, such as refugee camps.

<sup>13</sup><https://www.itu.int/itu-d/reports/statistics/2022/11/24/ff22-internet-use-in-urban-and-rural-areas/>



The great work done by Liquid Telecom, another WBA member, to connect the unconnected is also noteworthy. Liquid Intelligent Technologies, which operates in 16 African countries, is responsible for several initiatives in the continent, including connecting 5,000 schools (target 145,000) and 2,000 community anchor institutions in South Africa, working with key partners such as UNICEF, Microsoft, and the ITU. Liquid Telecom is building and sharing its best practices for Wi-Fi deployment to ensure networks are sustainable, applicable to the local population, and well-designed.

Another technology driving access to Wi-Fi in rural areas is the Telecom Infra Project (TIP) OpenWi-Fi. By disaggregating the hardware with the service, TIP OpenWi-Fi promises to bring the benefits of software-defined networks into wireless networking. The TIP approach to OpenWi-Fi creates an open-source disaggregated technology stack without vendor lock-in. This will make Wi-Fi more affordable in price-sensitive markets such as villages in India and schools in Kenya.

<sup>14</sup> <https://schools.liquid.tech/>

## 5. Wi-Fi Technology Evolution

Wi-Fi innovation and adoption are accelerating to meet the exponential demand for Wi-Fi. A high number of products—915—have now been Wi-Fi 6/6E certified, and more than 60 countries will open 6GHz band for Wi-Fi, according to the Wi-Fi Alliance.

The market has also adopted Wi-Fi 6/6E in an unprecedented way. Numerous large-scale deployments serving thousands of users across enterprise, healthcare, education, sports, and entertainment demonstrate Wi-Fi 6E momentum. IDC reports that 473 million 6GHz devices will enter the market in 2023 and predicts 6GHz will represent nearly 20 percent of Wi-Fi 6 shipments, growing to 1.1 billion in 2025. The analyst firm also reported that close to 100 million Wi-Fi 6E access points will be shipped in 2023.

With gigabit Wi-Fi offerings, leading organizations like Cable Labs, Turk Telekom, and Orange have launched Wi-Fi 6/6E initiatives. Turk Telekom Wi-Fi 6E trial achieved connection speeds of 2 Gbps and above with low latency. At the same time, Deutsche Glasfaser consistently delivers 0.7 to 0.9 Gbps mesh backhaul links over 6GHz in real-world deployments.

While the discussion is now turning to Wi-Fi 7, which leverages the work done on Wi-Fi 6/6E and the abundance of the new 6GHz spectrum, the industry wants to take advantage of the capabilities and performance provided by Wi-Fi 6/6E even as Wi-Fi 7 is commercially available.

On top of the Institute of Electrical and Electronics Engineers (IEEE) standardization work, innovation is happening on different fronts. Features include Wi-Fi sensing, AFC, increased convergence with 5G, and OpenRoaming, thanks to the work of WBA member companies.

### 5.1 Key Updates on Wi-Fi Standards

The IEEE has been working on the next generation 802.11be extremely high throughput (EHT) standard (also known as Wi-Fi 7), aiming to improve the quality of experience for real-time applications such as AR/VR/XR. The market is asking for Wi-Fi to provide higher speeds and capacity and to become more deterministic and predictable to support emerging use cases that require very low latency, even in areas of high interference. The work of the IEEE is to respond to these market demands and turn them into standardized features. Wi-Fi 7 will deliver more advanced experiences in 2.4 and 5GHz, providing maximum benefit to users in countries that make the entire 6GHz band available.

Wi-Fi 7 allows channel widths up to 320 MHz, doubling the bandwidth compared to the 160 MHz channels in Wi-Fi 5 and Wi-Fi 6/6E. Wi-Fi 7 devices with multi-radios can leverage multi-link operations in 2.4 GHz, 5 GHz, and 6 GHz bands, enabling seamless switching between the links to move critical applications to higher bands and aggregate the links where/when needed. With wider channels, MLOs, and 4K QAM capabilities, Wi-Fi 7 can deliver speeds over three times faster than Wi-Fi 6.

Wi-Fi 7 will offer significant advancements with extremely high throughputs, low latency and jitter, and high reliability, as shown in Figure 6.

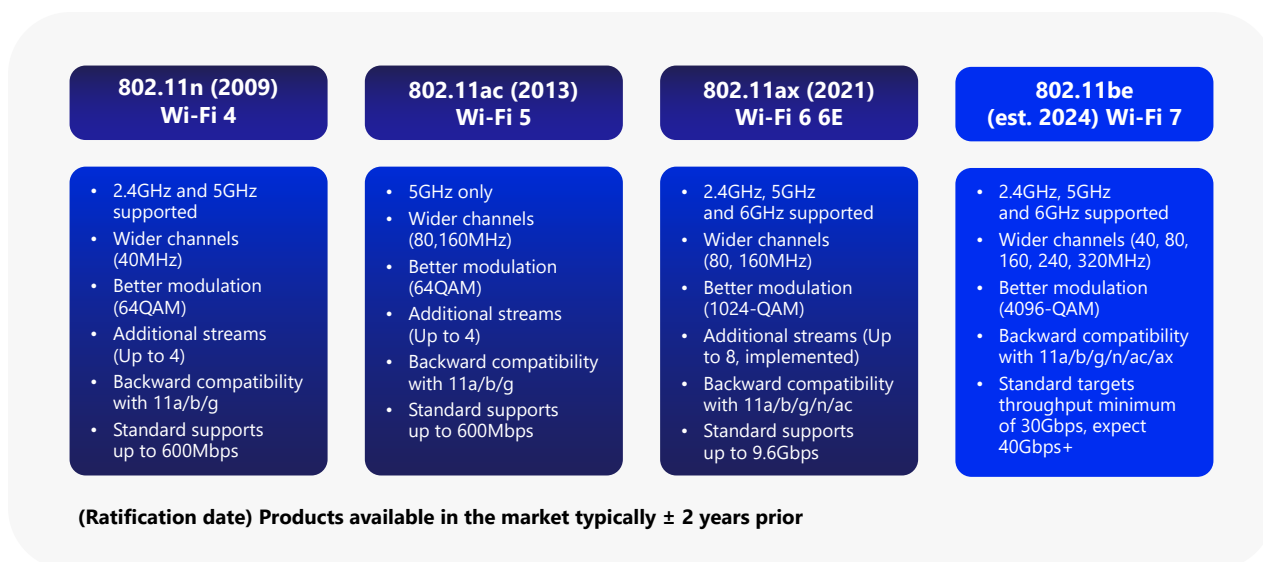

Figure 9: IEEE 802.11 Wi-Fi standard MAC/PHY evolution

Source: IEEE

On the MAC layer, the most mature feature is multi-band/link multi-channel aggregation and operation.

Multi-Access Point (AP) Coordination (i.e. coordinated and joint transmission)—to reduce overlapping basic service sets (BSS) and minimize collisions over the air—is not mature yet and will most likely be included in the successor to the 802.11be amendment.

Following the draft specifications, manufacturers are working to release the first routers before the final MAC specifications are completed. Devices will then be updated to support the final specifications. PHY specifications are finalized at this stage.

Regarding the timeline, the IEEE expects board approval by May 2024, with official standardized Wi-Fi 7 devices entering the market in 2025. However, chipsets for Wi-Fi 7 have been available since 2022, and 67 devices have already implemented Wi-Fi 7 features, according to Intel:

W6E + W7						
		83 +105%	630 +389%	470 +59%	802 +64%	Latest HoH Delta
TOTAL	79	162	792	1262	2064	802 +64%
	H1 2021 (Q2 2021)	H2 2021 (Q4 2021)	H1 2022 (Q2 2022)	H2 2022 (Q4 2022)	H1 2023 (Q2 2023)	HoH Delta
LT	39	72	393	537	1052	515 +96%
DT	7	18	124	183	305	122 +67%
DT MB	13	25	96	220	249	29 +13%
TAB/Other		1	20	46	71	25 +54%
Phone	8	14	61	90	113	23 +26%
Rtr/Gtw	8	18	41	72	114	42 +58%
AP	1	11	36	64	91	27 +42%
TV	3	3	21	50	69	19 +38%

Figure 10: Wi-Fi Device Tracker

PCD (Personal Computing Device) = LT (Laptop PCs) + DT (Desktop PCs) + DT MB (DT PC Motherboards) + TAB/Other (Tablets, HH computing/gaming, VR Headsets, Video Streamers)

Phone = Smartphones

AP = Rtr/Gtw (Routers & Gateways) + AP (Access Points)

TV = Televisions

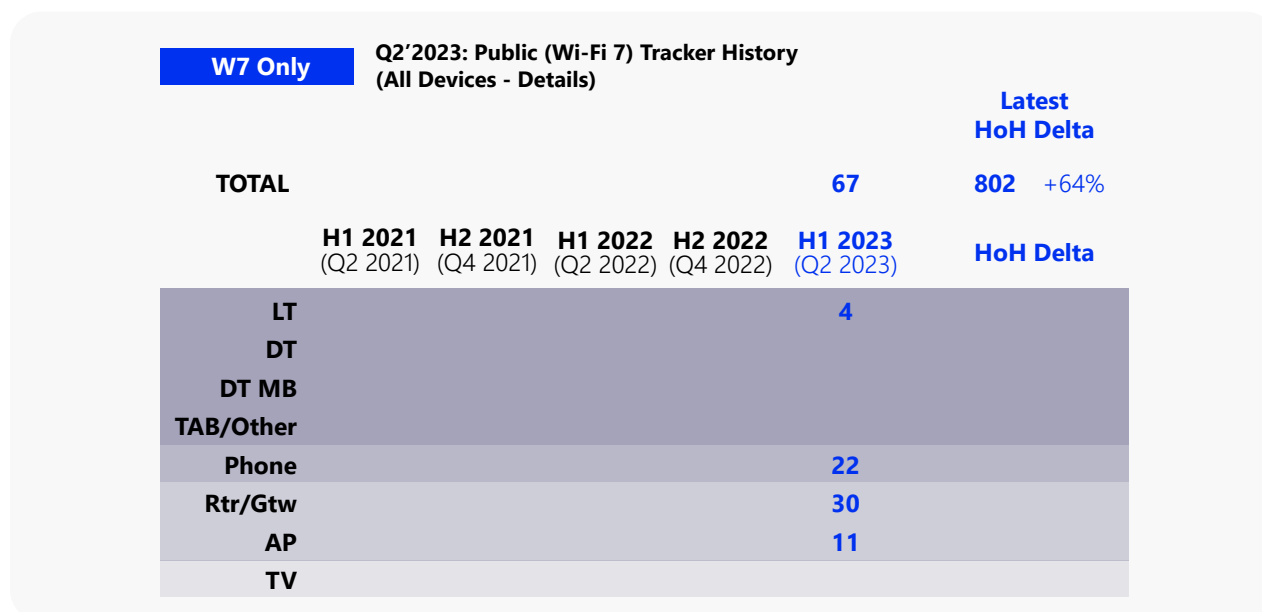

Figure 11: Wi-Fi Device Tracker History - Q2'2023

"The Wi-Fi 6E and new Wi-Fi 7 device tracking data is based on public information compiled from press releases, third-party reviews, and vendor/retailer websites." "Intel provides this assessment for informational purposes only. Intel cannot guarantee its accuracy and is subject to change without notice."

Source: Intel

Power users will be the early adopters of Wi-Fi 7, especially if ISPs tier the latest Wi-Fi generation as a premium, low-volume product for a period. IPTV/XR/VR will drive the mass take-up and high concurrent demand within the home or venue. Additional Wi-Fi 7 enhancements will support reduced latency and jitter for time-sensitive networking applications, including 4K and 8K video streaming, automotive, cloud computing, gaming, video applications, and mission-critical and industrial applications. Like other generations, Wi-Fi 7 will be backward compatible and coexist with legacy devices in the 2.4, 5, and 6GHz spectrum bands. The WBA published a white paper analyzing Wi-Fi 7 new capabilities to key use cases in residential, enterprise, and industrial environments. It concludes that Wi-Fi 7 significantly improves connectivity by delivering enhancements in higher speed, lower latency, better reliability, and efficiency while supporting more devices in high-density deployments.

Other relevant work from the IEEE includes:

- 802.11bf WLAN Sensing (more in section 6)
- 802.11bh Randomized MAC Addresses

<sup>15</sup> <https://wballiance.com/resource/get-ready-for-wi-fi-7-applying-new-capabilities-to-the-key-use-cases/>

<sup>16</sup> <https://grouper.ieee.org/groups/802/11/index.shtml>

- 802.11bi Enhanced Data Privacy
- P802.11bk 320MHz Ranging.

The IEEE continues to explore the work on the horizon. In 2022, the Ultra High-Reliability Group defined the scope and purpose of the next MAC/PHY project, which will be the successor of 802.11be (aka 802.11bn). The study group will investigate technology that could improve the reliability of WLAN connectivity, reduce latencies, increase manageability, increase throughput (including at different SNR levels), and reduce device-level power consumption. In March 2023, the project authorization request was approved in WG11, and the task group (for 802.11bn)start work in November 2023. The IEEE also approved a study group to investigate integrated millimeter wave also starting in November 2023.

A second important area of investigation by the IEEE is the use of artificial intelligence (AI)/machine learning (ML) in WLAN networks. The goal is to describe use cases for AI/ML applicability in 802.11 systems, investigate the technical feasibility of features, and enable support of AI/ML. The current applications focus on performance improvement parameter selection for channel access control and link adaptation, multi-user parameters, contention window sizes, channel usage, and improved BSS transition.

Finally, the IEEE is investigating WLAN support of ambient power (energy harvesting) in very low-power operations such as temperature sensors that capture energy from their surrounding environment.

## 5.2 Key Technology Innovation

Technology innovation happens beyond the IEEE standardization to encompass advanced features and protocols to make the Wi-Fi experience more stable, secure, and seamless.

### 5.2.1 Evolution to Deterministic Wi-Fi

In previous editions and sections of this report, we mention that Wi-Fi needs to become more deterministic and predictable to support emerging use cases such as XR/AR/VR, Industrial IoT/Automation, and 3D video that require high bandwidth and low levels of latency (sub 5 ms) and jitter. The future wireless use cases will consume wider 120MHz channels in dense networks, raising the need to schedule transmissions and protect packets from interference. Figure 8 below shows that bounded latency is possible with the latest technologies and techniques, even in high-traffic scenarios.

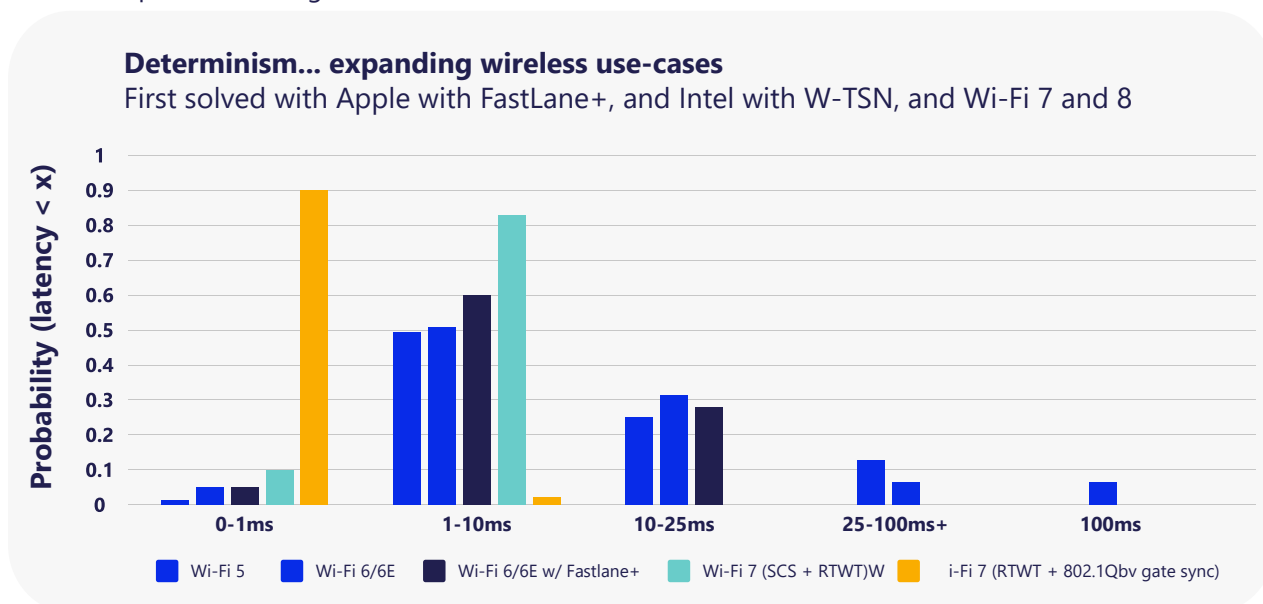

Figure 12: Determinism... Expanding Wireless Use-Cases

Source: <https://mentor.ieee.org/802.11/dcn/22/11-22-0634-00-00be-802-11be-enhancements-for-tsn-time-aware-scheduling-and-network-management-considerations.pptx>

Figure 10 shows test results obtained with different Wi-Fi generations and advanced techniques such as Fastlane, SCS, RTWT, and 802.1Qbv.

Wi-Fi 5 (SU) experiences very high variability (> >100ms worst case) and effectively unbounded latency, while Wi-Fi 6 (ULOFDMA) bounds maximum latency (<100ms). In the case of Wi-Fi 7 (SCS QoS Characteristics w/ 20ms period) there is significant latency gain with respect to Wi-Fi 6 (<25ms). 802.11be (SCS QoS characteristics w/ 20ms period + start time) is expected to bind latency to more stringent (<10ms) requirements. Finally, when combined with wireless TSN (802.1Qbv), the system manages E2E latency to within 1ms 98 percentile for scheduled traffic.

## 5.3 ID Management

The WBA community has been investigating the issues of MAC address anonymization for quite some time. It has identified a list of the effects of these changes to existing systems and solutions that can be explored to overcome the dependency on MAC addresses. The WBA published a white paper on Wi-Fi Devices Identification which details the requirements and the available solutions for many cases and makes recommendations for solutions across different verticals that a network operator may wish to adopt to overcome the issues introduced by MAC randomization. The paper also discusses the need for identities and the legal necessity to consider privacy and consent when identifying people.

The WBA hopes this work can help define a mitigation path and the necessary steps to update the Wi-Fi network ecosystem. Subsequently, the WBA members have also agreed on a priority set of use cases that a Wi-Fi identification standard should address. The WBA members have performed the market requirements analysis and matching technologies able to scale and achieve the longer-term sustainability of deployed services. More on how OpenRoaming deals with identity management is discussed in Section 9.

## 5.4 Wi-Fi Enablers

Wi-Fi standards provide a good foundation for further innovation to flourish and enable new use cases based on Wi-Fi. This section provides updates on the most notable Wi-Fi enablers.

### 5.4.1 AI/ML for Wi-Fi

As mentioned, AI and ML are increasingly used to help improve Wi-Fi network performance. ML is used to find “good” configurations” of 802.11 parameters, including channel access (e.g., collision reduction), link configuration (e.g., rate adaptation), and PHY-related (e.g., interference management). The industry is also becoming increasingly interested in using ML to improve:

- Beamforming - beam selection
- Multi-user communication - resource unit (RU) scheduling
- Spatial reuse - select transmit power
- Channel bonding - select channel and bandwidth

During the Wireless Global Congress Americas event in Las Vegas in June 2023, several presenters showed how AI helps improve radio resource management (RRM), troubleshooting with network analytics tools, autonomous networking, and other predictive mechanisms. The rising interest in AI/ML (see Figure 8) reflects the cumulative research about AI use by the 802.11 community.

<sup>17</sup> <https://wballiance.com/resource/wi-fi-device-identification-a-way-through-mac-randomization/>

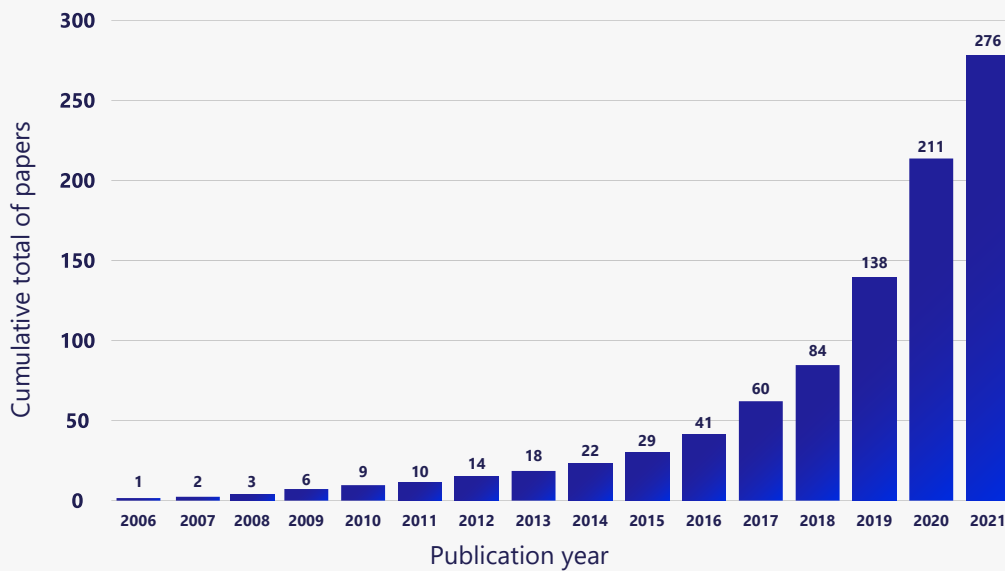

Figure 13: Research Interest in ML & 802.11

Source: Szymon Szott, AGH University

### 5.4.2 New Possibilities with Wi-Fi Sensing

Our previous report discussed Wi-Fi sensing at length, so in this report we will focus on the latest developments. The 802.11bf Task Group has been working hard since 2019 and has made considerable progress. Over the past few years, the group has released a series of drafts, and the final standard is expected in September 2024. IEEE members formed separate groups, including the WLAN Sensing Technical Interest Group, the WLAN Sensing Study Group, the WLAN Sensing Task Group, and the 802.11bf Task Group. These groups aim to develop a set of rules and guidelines for establishing and managing sensing sessions and proxy sensing sessions in the WLAN to generate and report suitable sensing measurements extracted from sounding signals to ensure Wi-Fi sensing works consistently across different Wi-Fi devices and manufacturers.

Once the IEEE 802.11bf standard is complete, Wi-Fi sensing will be easier to implement across various devices. Enabled by the wide availability of sensing measurements provided by 802.11bf and many AI technologies, new and innovative applications will be created, integrating Wi-Fi sensing in innovative ways.

Wi-Fi sensing can be deployed in various topologies in the home, including star topology, where the sensing agent resides on the access point. The processing power can be deployed on the edge or in the cloud. When deployed at the edge, the sensing agent ensures latency remains low and sensing is resilient to internet outages and does not compete with the user applications to perform the sensing. One of the critical sensing applications is to improve home security, as current alarm systems experience many false alarms and are expensive to install. Wi-Fi sensing requires fewer devices (three devices can cover 1,500 square feet), can be integrated into legacy devices, and is easy to deploy. Another critical application is fall detection for an ageing population. Since the technology is camera less, privacy is ensured, and adoption can be eased.

The WBA published a detailed white paper on [Wi-Fi Sensing Deployment Guidelines](#) in residential deployments. The paper provides knowledge of Wi-Fi Sensing performance and how it can be deployed in a home environment, identifying the relevant communication guidelines, and some constraints faced by Sensing.

### 5.4.3 Extended Realities — Applications and Drivers

The future will be immersive. According to Gartner, Inc., by 2026, 25 percent of people worldwide will spend at

least one hour a day in the metaverse for work, shopping, education, social interaction, and/or entertainment. Wi-Fi 6 and 7 are crucial to XR's success in home and enterprise indoor environments. Current wireless networks provide best-effort QoS and do not meet the XR requirements regarding latency, power, and quality of services. To support XR applications, Wi-Fi must provide better scheduling, interference management, and more efficient power usage.

Meta and Cisco have partnered to improve the Wi-Fi quality of service in the context of XR, particularly concerning packet traffic classification and prioritization for both downstream and upstream. These companies are testing downlink QoS policy improvement at the access point while fine-tuning the uplink QoS tagging to prioritize packets to ensure sub-5 ms latency, which is required for most XR use cases.

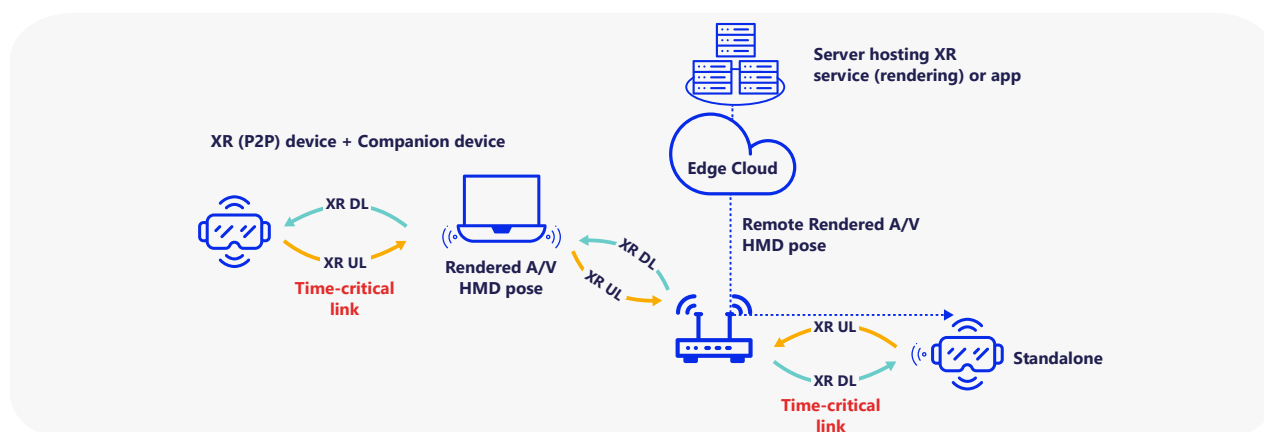

Figure 14: XR Remote rendering requires management of ALL Wi-Fi links

Source: Cisco/Meta

The bounded latency is enabled by the latest Wi-Fi 6E radios combined with the larger channels in the 6GHz band. A few of the most notable features that will unleash a great XR experience include:

- Broad, cell-wide support of multi-Gig speed (up to 160/320MHz channels)
- Efficient interference (e.g., DFS, AFC) avoidance (puncturing)
- SLA/SCS-based KPI delivery (bounded latency, jitter) in uplink and downlink
- Link aggregation and reliability (multilink operation/MLO)
- Optimum channel utilization (multi-resource unit/MRU flexibility)

The network performance requirements vary depending on the enterprise environment, the applications, the use case, and the density of devices.

For this vision of AR/VR to reach its potential, the building blocks must be in place, starting with a deterministic Wi-Fi with minimum latency and maximum throughput. More about this subject is discussed in section 9.3.

#### 5.4.4 Wi-Fi and IoT

With the advent of Wi-Fi 6/6E and its features to support many devices, Wi-Fi has become well-positioned to serve the IoT market. Wi-Fi 6/6E is ideal for connecting the smart home, and a notable benefit for IoT is a feature called Target Wake Time (TWT), which helps ensure client devices can save power and extend their battery life—a critical advantage for IoT devices. Wi-Fi 6/6E uses a combination of OFDMA and 1024 QAM modulation technologies to improve spectral efficiency and boost speed. Using a combination of technologies

<sup>18</sup> <https://wballiance.com/resource/wi-fi-device-identification-a-way-through-mac-randomization/>



also supports many devices in a confined area, which is now an essential consideration in the home where many appliances and other IoT devices are connected to the home hub, and several users may be consuming high-quality video, gaming, and AR/VR simultaneously.

Wi-Fi 6/6E can now also support many requirements for industrial use cases, with enhancements to latency, determinism, and power efficiency. In a smart factory, Wi-Fi might deliver the optimal cost/performance for high bandwidth cameras that power augmented reality services.

For use cases that require both determinism and ultra-high speed, up to 1.2GHz of spectrum is now accessible with Wi-Fi 6E. This provides multi-Gb/s data rates that key applications such as industrial AR/VR/MR, onboard video, and sensor fusion require to be scalable.

So, whether it's operating a fleet of high-tech robots or the more mundane task of collecting terabytes (TB) of factory floor analytics, Wi-Fi 6E has a prominent place in the future of industrial automation and logistics and, by extension, mission-critical enterprise.

### 5.4.5 The Case for HaLow

- Wi-Fi HaLow operates on sub-GHz RF (902–928MHz in the U.S.), which has several key benefits. Firstly, the signals travel further because these frequencies are lower than those of conventional Wi-Fi.
- Secondly, sub-GHz signals pass through objects, such as walls, windows, and doors, far better than conventional Wi-Fi signals. Wi-Fi HaLow signals are far less affected by building structures than conventional Wi-Fi signals and can easily reach outdoor locations.
- Thirdly, the RF frequencies that conventional Wi-Fi operates at are typically very congested with high interference levels. 2.4GHz is used by Wi-Fi, Bluetooth, and microwave ovens resulting in high levels of interference for any cameras trying to use a 2.4GHz Wi-Fi link. The 5 and 6GHz Wi-Fi technologies suffer less congestion, but the range of 5 to 6GHz is less than that of 2.4GHz (due to their higher operating frequencies).
- Lastly, Wi-Fi HaLow utilizes narrower channel bandwidths than conventional Wi-Fi. The narrower the channel bandwidth, the further RF signals can travel. Wi-Fi HaLow can use 1MHz channels, whereas the lowest channel bandwidth that conventional Wi-Fi can use is 20MHz. Figure 10 includes use cases for HaLow.

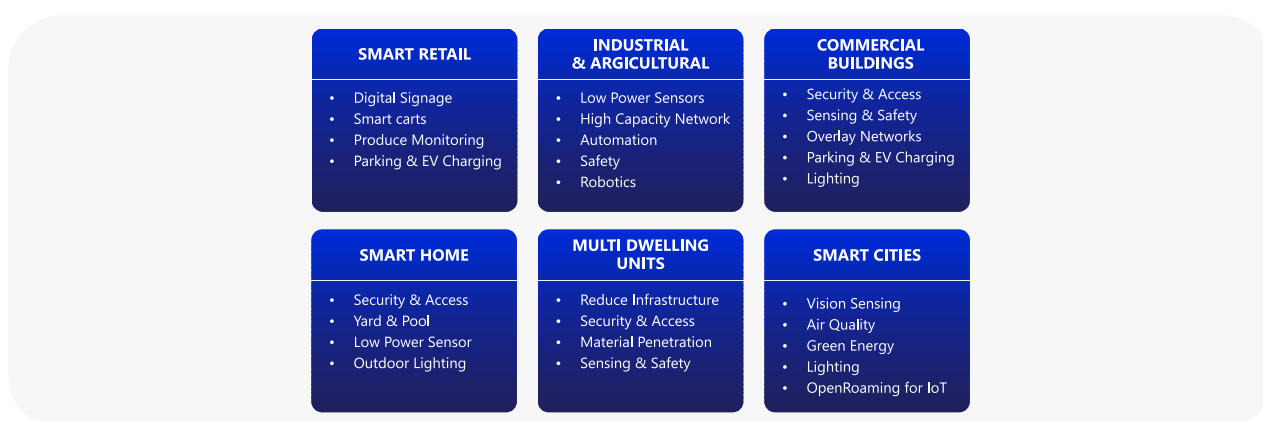

Figure 15: HaLow use cases.

### 5.4.6 Wi-Fi Security and Privacy Issues

Wireless security is critically important for protecting wireless networks and services from unwanted attacks, breaches and access. Left unprotected, unauthorized users can easily gain access to a wireless network and disrupt operations and steal sensitive data.

According to a 2023 survey by Forbes , 43% of respondents have had their online security compromised while using public Wi-Fi. The riskiest places to use public Wi-Fi, as perceived by the respondents, are hotels, airports, and cafes or restaurants.

Wi-Fi security and privacy are based on industry standards, including the WPA3, which provides a longer encrypted key chain than cellular with the equivalent 192-bit cryptographic strength. The WBA's Public Keying Infrastructure (PKI Radsec) for secure exchanges, [Wireless Roaming Intermediary Exchange \(WRIX\)](#), and Wi-Fi Alliance's Wi-Fi CERTIFIED Passpoint provide enhanced security and enable the federation to scale quickly.

With [OpenRoaming](#), security and privacy, and judicial use of identity (or identities) are built in as part of the standard. OpenRoaming leverages secure authentication protocols such as RadSec, EAP-Transport Layer Security (EAP-TLS), EAP-Tunneled TLS (EAP-TTLS), or EAP-Authentication and Key Agreement (AKA). All authentication traffic is TLS encrypted. OpenRoaming networks are secure networks and leverage Wi-Fi Protected Access (WPA)2-Enterprise or WPA3 over-the-air encryption, and as such offer enterprise-grade protection, unlike current open wireless guest networks.

OpenRoaming Release 3 enhanced Identity Proofing so that identity providers are able to meet regulatory/legislative requirements as well as corporate and business requirements that ensure a user is who they say they are, guaranteeing the use of Wi-Fi Hotspots with OpenRoaming is safer for all. With release 4, OpenRoaming is extending its reach to Private 5G and IoT.

Data privacy most often involves properly handling personal info like Social Security numbers, health records, and financial records and information. Businesses continually collect user data to inform their targeted ads and may often use consumer's lack of knowledge to collect more data than they should. Indeed, personal data has become a valuable commodity over the past few decades as marketing technology and artificial intelligence capabilities have grown. Algorithms can now easily collect and analyze large amounts of user data, allowing companies to fine-tune and personalize their ad campaigns. Billions of pieces of data are stolen each year globally. In 2022, 422 million individual users were affected by some sort of data breach in the U.S., with some people impacted by multiple violations . While companies must meet regulatory requirements concerning how they collect, use, and share user data, keeping sensitive information private falls largely on individuals themselves.

### 5.4.7 TIP OpenWiFi Recent Developments

TIP released its latest version, of OpenWiFi in September 2023 which includes upgrades to key prerequisites for Wi-Fi : 7Linux Kernel 5.4 and QSDK. The First Wi-Fi 7-enabled OpenWiFi devices will ship in Q1 '24. The Development and integration with GlobalReach Technology on One-Click OpenRoaming was released in late September 2023.

Integrating the switching stack to the AP stack—OpenWiFi has formally launched the OpenLAN Switching Subgroup, which produces POE++ capable Switches with both Layer 2 and Layer 3 capabilities.

### 5.4.8 Other Enablers

Other exciting areas of research that will open many new market opportunities include, among others, the development of indoor positioning using Wi-Fi triangulation, ultra-wideband, Bluetooth, beacons, and RFID with applications ranging from retail location-based services to healthcare asset tracking. We mentioned the work with 802.1as (timing and synchronization) and 802.1 Qvb (traffic scheduling) for time-sensitive networking that will enable Wi-Fi networks to provide a more deterministic experience. Another area of work is the integration of radius with diameter. Diameter is a next-generation industry-standard protocol used to exchange authentication, authorization, and accounting (AAA) information in Long-Term Evolution (LTE) and IP Multimedia Systems (IMS) networks. This is work relevant to the Wi-Fi and P5G convergence effort.

<sup>19</sup> <https://www.forbes.com/advisor/business/public-wifi-risks/>

<sup>20</sup> Statista: <https://www.statista.com/statistics/273550/data-breaches-recorded-in-the-united-states-by-number-of-breaches-and-records-exposed/>

## 6. Top 10 Predictions Covering Next 3-Year Time Horizon

### 6.1 Wi-Fi 6/6E

Internet service providers (ISPs) deliver faster internet speeds than ever. AT&T Fiber is already providing 5 Gbps, and Comcast is testing DOCSIS 4.0, leading to a future where 10 Gbps speeds will be commonplace. To experience the actual benefits of these advancements, Wi-Fi must follow suit. The massive increase in video-heavy traffic also puts new burdens on the capabilities required of a Wi-Fi network which drives investment in new technologies. Fiber broadband deployments will continue to expand in most developed and developing markets, creating a need for an upgrade of home Wi-Fi networks to pass on the increased bandwidth to the device. The rapid adoption of Wi-Fi 6/6E will also be driven by its ability to access additional spectrum in the 6GHz band via the 6E extension as more countries open the band. The 2023 World Radiocommunication Conferences (WRC) should bring new developments in the 6GHz allocation. The WRC-23 agenda includes an item about potential 5G operations in the mid-band spectrum, though developing a spectrum pipeline has been a contentious issue in recent years.

### 6.2 Wi-Fi 7

Gaming and immersive experiences will drive the need for Wi-Fi 7 capabilities. According to a recent report by Bain & Company, the gaming industry's growth has accelerated because of the unprecedented engagement of younger teenage gamers who spend about 40 percent more time in video game environments than in using any other form of media. The exact report forecasts that global revenue for video gaming could increase by another 50 percent over the next five years. In a sport where milliseconds count, networking equipment will be just as crucial to the game as the speed of the gaming rig. Wi-Fi 7 will be critical for speed and near-zero latency, and game developers will break new barriers with immersive experiences. Wi-Fi 7 client devices have already been released in 2023 with Qualcomm chipset with more to come in 2024.

### 6.3 OpenRoaming

Deployments of Passpoint and OpenRoaming continue to rise as more brands and identity providers recognize the value of the federation to enable seamless connectivity access across different networks. OpenRoaming will reach a critical point of exponential growth by 2026 when tens of millions of hotspots will be enabled. Beyond Wi-Fi, OpenRoaming will extend to integrate with private 5G and IoT in 2024. OpenRoaming has the potential to remove the friction to connect billions of IoT devices securely.

### 6.4 Network as a Service

Network as a Service (NaaS) is defined as network infrastructure hardware, software, services, management, and licensing components consumed in a subscription-based or flexible consumption model. NaaS is on the rise, and early adopters include managed Wi-Fi in multi-apartment units, soon to spread among traditional enterprises where networks provide cloud-first, software-defined, application-centric environments. The NaaS model is driven by enterprises' inability to keep up with the pace of innovations in the context of skilled labor shortages and a shortened equipment replacement cycle, which means financial pressure exists to move away from the traditional CAPEX model. The prevalence of security attacks is another reason more enterprises will move to NaaS. In a NaaS model, the NaaS provider delivers continuous security updates that prevent and reduce breaches and outages, resulting in higher productivity and customer satisfaction.

### 6.5 AI/ML

The role of AI (artificial intelligence) and ML (machine learning) cannot be overstated. Adaptive AI usage

<sup>21</sup> <https://www.bain.com/insights/level-up-the-future-of-video-games-is-bright/>

will explode from enabling AFC coordination to predicting network resources. WLAN vendors are developing their secret sauce versions of AI to differentiate themselves in an environment where the hardware is fully standardized. AI will help enterprises and ISPs speed up troubleshooting; streamline monitoring; and proactively anticipate outages, equipment failures, and performance degradation. In the AFC context, AI will manage radio resource, manage power from the devices and the infrastructure, and perform cross-network coordination to maximize frequency re-use and, thus, capacity.

## 6.6 AFC

We expect 6GHz low-power indoor (LP) devices with an average transmit power of 24 dBm to proliferate quickly for indoor applications such as residential mesh, indoor public venues, and high-density enterprise networks. We also expect 6GHz very low-power indoor (VPI) devices with 14 dBm maximum transmit power to be quickly adopted for short-range indoor applications such as AR/VR/XR, streaming, and gaming. These device classes do not require Automated Frequency Coordination (AFC) coordination with the incumbents. For standard power device classes with a maximum transmit power of 30 dBm, the road to adoption will be slower because there is much to be done on the technology side for the solution to mature and stabilize all the advanced features and mechanisms that will ensure the lowest possible interference with both incumbents and new users, especially in dense environments. Outdoor AFC will initially be successful in rural connectivity in countries that have opened large portions of the 6GHz to Wi-Fi.

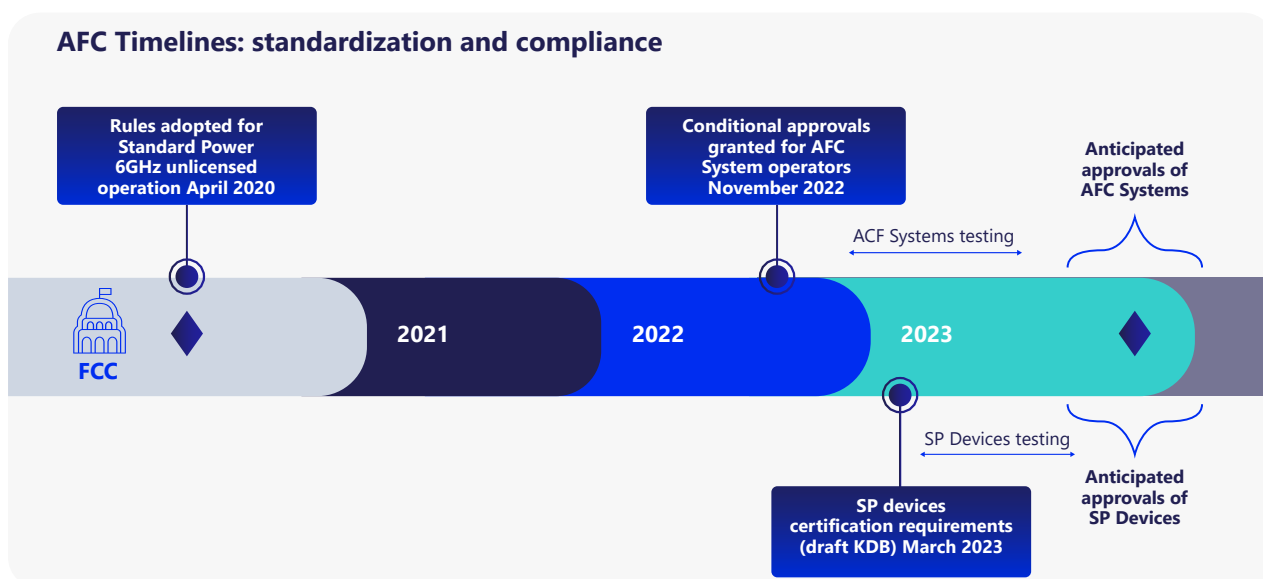

Figure 16: AFC timeline

Source: Qualcomm

## 6.7 New IoT Tech

A pain point for consumers has always been that smart home devices manufactured by different companies do not necessarily work together, which diminishes the home user’s experience with IoT devices. However, Matter—an industry-unifying standard launched in 2023 that provides reliable, secure connectivity across multiple device manufacturers—promises to change that. Matter is an open-source protocol that allows users to connect smart home devices and mobile apps from different manufacturers using Wi-Fi or Thread protocols and Bluetooth LE for easy commissioning. Given the weight of players (e.g., Apple, Amazon, Google, Samsung SmartThings), we expect the adoption of Matter-certified products will be exponential in the next three years. This will again validate Wi-Fi’s central role in the smart connected home and building. Given the throughput, coverage, and latencies required, we expect Halow to also make its way into the home, with security wireless cameras as one of the primary use cases in the near term.

## 6.8 TIP OpenWiFi

We expect pilot projects and trials to proliferate in developing countries and price-sensitive markets in India and Africa. As Meta's support for the initiative dwindled, the pace of innovation and go-to-market effort may be impacted. We expect TIP OpenWiFi to face an uphill battle against well-established wireless local-area network (WLAN) vendors that increasingly differentiate themselves and improve their radios thanks to massive investments in machine learning and AI and an integrated Wi-Fi + 5G offering to enterprises. Another uncertainty for TIP OpenWiFi is how its community of cash-strapped small vendors will compete against the HPEs, Cisco and CommScope in the context of the NaaS adoption, ML and 5G convergence.

## 6.9 Metaverse

According to Bloomberg, the metaverse's economy is expected to generate \$800 billion by 2025 and \$2.5 trillion by 2030. Thus, the metaverse is the universe of the future. Major brands are making substantial investments in this technology. Augmented and virtual reality will gain a larger share of our daily lives at home and work. As discussed, indoor broadband networks must adapt to these new requirements. Improvements in user interfaces and network capability will be required to cater to the needs of a larger group of users.

There is a list of essential things that can be done in the metaverse that will lead to exciting business opportunities. The newest technologies power these opportunities and have high realism in many different areas, which include:

- Shopping in malls and online stores.
- Virtual learning for students via digital classrooms.
- Creating digital twins for manufacturing and industries.
- Online gaming.
- Buying avatars, accessories and things to wear.
- Buying and selling digital assets like NFTs, artworks, and more.

## 6.10 Wi-Fi and 5G/6G Convergence

Convergence is progressing toward enabling access to private or public 5G services over Wi-Fi. The WBA details the possible deployment models for bringing 5G into enterprise networks in its paper "Private 5G And Wi-Fi Convergence – Key Use Cases and Requirements"

Full convergence requires standardization and a common core network which will only develop in incremental steps. Building a common core simplifies the network architecture and reduces the operational cost with function re-use. In the meantime, interworking between the access systems for realizing IP address preservation across inter-access handovers can be realized in simpler terms by collocating 5G core network elements with WLAN controller and can be the preferred option for most deployments with existing Wi-Fi footprint.

Rather than competing with 5G over emerging high-performance use cases, the Wi-Fi community continues to work on coexistence with 5G, especially around identity management, authentication, and policy management. This suggests that large enterprises are already deploying private 5G because they want synergy with Wi-Fi.

We expect network executives will continue deploying Wi-Fi and cellular in the coming years, with Wi-Fi 6/6E for indoor, on-campus, and fixed network situations and 5G/cellular for outdoor, off-campus, and mobile environments. Wi-Fi 7 may not sufficiently close the gap with 5G enough to persuade some enterprises to select it for more demanding use cases. 5G is not standing still; enhancements are coming with 3GPP Release 17 under the banner of 5G Advanced.

<sup>22</sup> <https://wballiance.com/resource/private-5g-and-wi-fi-convergence-key-use-cases-and-requirements/>

## 7. Convergence of Wi-Fi and Other Radio Access Technologies

There is not yet a one-size-fits-all wireless protocol for our most important electronic devices, and until such a technology is invented, we will need to use a blended approach. To this end, Wi-Fi was never designed to live in isolation, although it is perhaps the most flexible wireless protocol in a modern smartphone.

Given enough time, there might be a development roadmap to see Wi-Fi fully converge with cellular standards or low-power standards like Bluetooth and LoRaWAN. For now, the different stakeholders in these camps need to cooperate to ensure the best outcomes for end-users. The WBA has always pursued the goal of improved coexistence with other wireless networks, and this shows no sign of changing in the short to medium term. To this end, it has worked with the LoRa Alliance to identify use cases and complimentary functions between LoRaWAN and Wi-Fi. The WBA's position is that there are use cases that will naturally fit Wi-Fi and others that suit cellular protocols, and where both make sense, the WBA has defined the roadmap and is collaborating with other industry bodies to bring it to fruition.

### 7.1 Wi-Fi 6E, 7, & 5G – Convergence & Key Milestones

The past year has seen significant progress in Wi-Fi and 5G camps. For the former, Wi-Fi 6E has begun making its mark in the 6 GHz band, and the development of Wi-Fi 7 (IEEE 802.11be) continues apace. The first Wi-Fi 7 routers are expected to launch in 2023, ready to exploit the widened availability of 320 MHz bandwidth in the 6 GHz band. CES 2024 will likely host various product announcements for Wi-Fi 7 devices. This is explored further in section 6.1 of this report.

The list of countries that have approved 6 GHz operations for Wi-Fi has grown, although progress in Asia-Pacific, the Middle East, and Africa (ME&A) has been slow. To date, there are 5 countries in APAC and 8 countries in ME&A that have approved partial 6 GHz usage, of which only 1 in each region has granted full usage.

According to the Wi-Fi Alliance, no countries have only adopted the upper 6 GHz band. Notably, three separate studies from Analysis Mason, Ericsson, and the OECD, point to slowing growth in mobile traffic volumes – undermining the argument that the MNOs need more spectrum to support their networks.

For the entire 6 GHz band, the 12 countries that have adopted it are Brazil, Canada, Colombia, Costa Rica, Dominican Republic, El Salvador, Guatemala, Honduras, Peru, Saudi Arabia, South Korea, and the United States.

As for cellular development, the 3GPP Release 17 specifications were finalized in March 2022, adding enhancements for unlicensed spectrum usage, the Reduced Capability (RedCap) mode for IoT devices, and support for Non-Terrestrial Networks (NTN). These are explored further in a later chapter.

<sup>23</sup> <https://wballiance.com/resource/wi-fi-lorawan-trials/>

<sup>24</sup> <https://www.wi-fi.org/countries-enabling-wi-fi-in-6-ghz-wi-fi-6e>

<sup>25</sup> <https://6ghz.info/the-mobile-slowdown-and-what-it-means-for-spectrum-policy/>

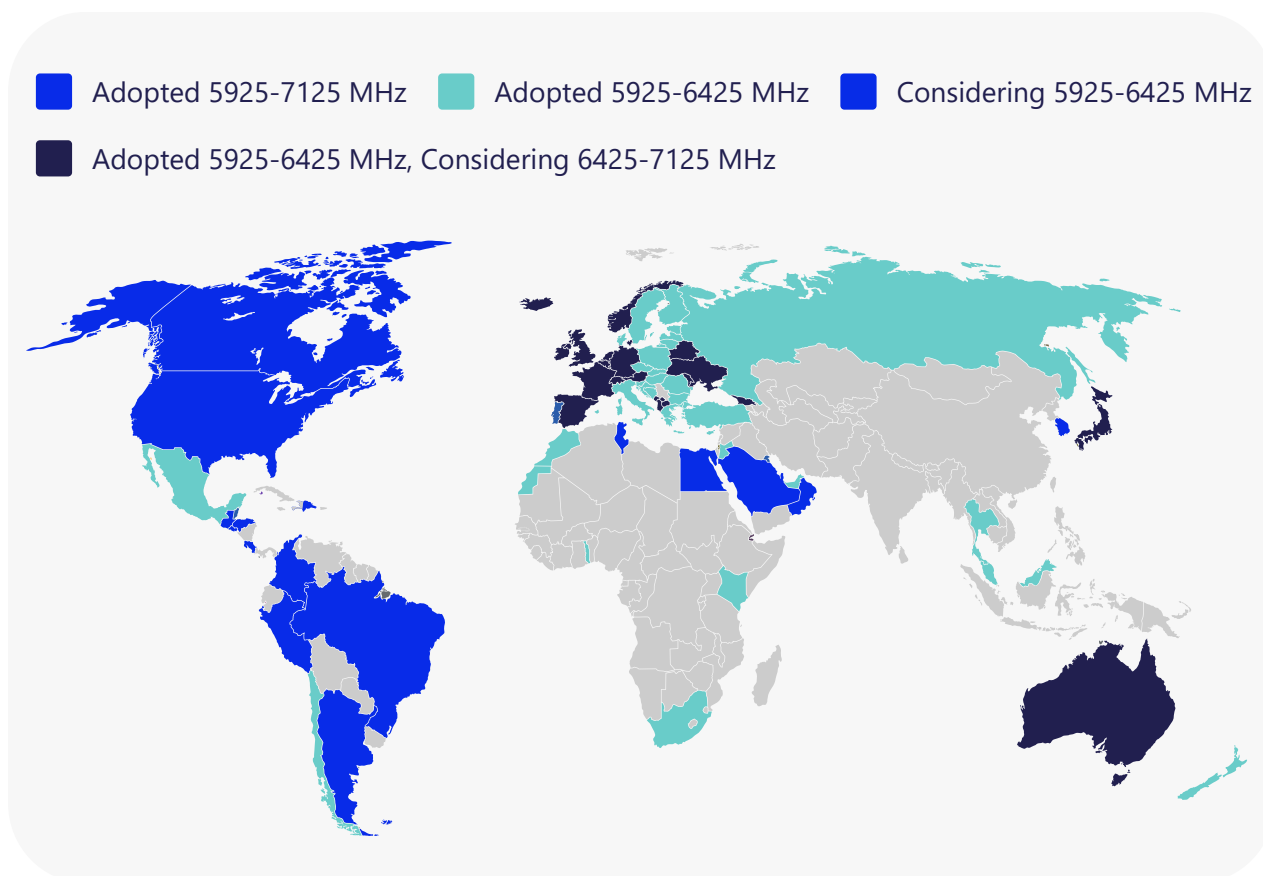

Figure 17: The Wi-Fi Alliance map of 6E spectrum allocations.

Release 17 was built on the June 2020 publication of Release 16, which added support for the 5G Standalone modes and the associated network slicing and multi-access networks capabilities. These enabled the management of 5G and Wi-Fi, alongside fixed-line options, in a unified network management interface. Release 16 also added ultra-low latency features and saw the arrival of 5G New Radio Unlicensed (5G NRu), for unlicensed spectrum. This too is explored in a later chapter.

Work on Release 18 is underway, to enable the 5G Advanced feature set. The finalization date is now expected in March 2024, when the specification will be frozen, and the focus will move to Release 19.

Most of the new 3GPP specifications are being developed with private networks in mind, as there is now a greater need for coexistence between cellular and Wi-Fi. Just as Wi-Fi 6 and 6E made Wi-Fi more ‘cellular-like,’ with improvements to its latency, device hand-off, and reliability, the 5G NR developments have brought cellular closer to Wi-Fi – via multi-gigabit peak speeds, and spectrum flexibility. Nowadays, there is an argument to be made that the main differences between the technologies are the organizations that deploy and monetize them, and their surrounding ecosystems, and not so much the technological standards themselves.

The past couple of years have seen the two communities target an overlapping set of user cases, mostly focused on expanding the traditionally consumer-focused wireless broadband models more deeply into enterprise and wireless networks.

However, it is important to consider the different requirements for use cases. For instance, a packed sports stadium will need to focus on supporting a dense user footprint, while a high-tech industrial facility will need to prioritize low-latency and network resiliency.

Thankfully, industry thinking has shifted in the past decade. Historically, a single-technology approach would have

been pursued, but now, most agree that combining complementary networks is better. A recent estimate from the Dell’Oro group believes that enterprise-grade Wi-Fi 7 products will be available from most manufacturers in 2024 and that the wireless LAN market will grow to around \$5 billion in 2027.

As such, airports, seaports, and the like can now reliably go to the vendors and receive a combination of cellular for mobile functions and Wi-Fi for the high-bandwidth in-building functions – without suffering through a sales pitch that promises a nascent single-technology solution.

To this end, the WBA is highly active in promoting convergence and cooperation between technologies and those that deploy them to support a wide range of industrial use cases. The archive of white papers demonstrates this track record.

According to Tiago Rodrigues, CEO of the WBA, the combination of cellular and Wi-Fi delivers the most reliable, high-quality, and ubiquitous wireless experience, underpinning emerging applications and future concepts such as the industrial XR.

“Both 5G and Wi-Fi 6 technologies are critical for the evolution of connectivity and the digitalization of the planet as a whole,” said Rodrigues. “While the focus for cellular is on wide-range coverage, Wi-Fi focuses more prevalently on indoor coverage and high bandwidth connectivity.”

This is not just for the benefit of the wireless industry. However, these are significant – increased scale and addressable market for devices and equipment, and a more comprehensive range of opportunities to be addressed by vendors and service providers. But most importantly, progress on coexistence and convergence addresses an essential requirement of enterprises, many of which are currently evaluating their next-generation strategies for wireless connectivity to support activities such as digital transformation and Industry 4.0 programs.

### **7.1.1 Wi-Fi Alignment with 5G and 5G New Radio Unlicensed (NRu)**

The 3GPP, the organization that develops cellular standards, made a significant step forward with its Release 16 specifications, by adding support for unlicensed spectrum. This step was based on the LTE standards for unlicensed spectrum, specifically LTE Unlicensed (LTE-U), LTE Licensed Assisted Access (LTE-LAA), for carrier aggregation, and MulteFire. These were developed late in the game, for the LTE adoption cycle, and so did not see much adoption.

However, things have changed significantly since Release 16’s arrival in July 2020. Release 17 was finalized in March 2022, and added Reduced Capability (RedCap) modes, enhancements to IoT and Non-Terrestrial Networks (NTN) functions, improvements for network slicing and network automation, and enhanced support for non-public networks.

Notably, the Alliance for Private Networks (APN previously MulteFire Alliance) has signed a Memorandum of Understanding (MoU) with the 5G Alliance for Connected Industries and Automation (5G-ACIA), to jointly research and develop private networks in both licensed and unlicensed spectrum.

The impetus behind the 5G New Radio (NR) development was to support the expanded spectrum bands that are key to 5G’s value proposition. The NR specifications define two frequency bands. Frequency Range 1 (FR1) spans 410 MHz to 7,125 MHz, while Frequency Range 2 spans 24,250 MHz to 71,000 MHz. FR2 is, therefore, for the millimeter wave spectrum (mmWave).

The 5G NR-U specs are the first time the 3GPP has defined a solely unlicensed operational mode. It was built on top of work done by the MulteFire Alliance, now the APN. This enabled both upstream and downstream traffic to operate in the unlicensed bands and regular carrier aggregation, where some unlicensed spectrum is used to

<sup>26</sup> <https://www.3gpp.org/news-events/3gpp-news/advanced-5g>

<sup>27</sup> <https://www.3gpp.org/specifications-technologies/releases/release-18>

<sup>28</sup> <https://www.rcrwireless.com/20230802/wi-fi-2/enterprise-grade-wi-fi-7-revenues-to-exceed-5-billion-in-2027-delloro-group>

<sup>29</sup> <https://wballiance.com/resources/wba-white-papers/>



augment downlink in licensed bands. NR-U, therefore, allows for complete independence of the MNOs.

Most of the early usage for the unlicensed 5G NR-U systems will be found in Frequency Range 1 (FR1), the sub-7GHz range, as allocated by the ITU. 1. Flexible spectrum allocation targeting enterprise use cases has been confirmed, with the USA’s 3.5 GHz CBRS band particularly viable. Because it was developed at the start of the 5G deployment cycle, 5G NR-U should be more economically attractive for vendors to support and promote than LTE-U.

There is considerable interest among enterprises for deployments that combine 5G and Wi-Fi, particularly in using spectrum bands that do not require ownership of exclusive licenses. Enterprise-focused vendors like Cisco and HPE Aruba have begun tailoring products and services to suit this interest, leveraging 5G NR-U’s ability to operate without a licensed ‘anchor’ network.

Furthermore, there has been considerable effort in developing 5G NR-U to mitigate concerns from Wi-Fi stakeholders regarding interference. Adopters of 5G NR-U aim to avoid the issue entirely by deploying it outside of the ISM bands that Wi-Fi uses – 2.4 GHz, 5.8 GHz, and now elements of the 6 GHz in Wi-Fi 6E and 7. There are, however, share spectrum allocations, such as the CBRS band in the USA. Japan, the Netherlands, and the UK are some of the more prominent.

In 5G NR-U, support for synchronized spectrum sharing was added, which is being leveraged by the CBRS band’s Spectrum Access System (SAS), and which has served as an example for other national regulatory regimes. A later chapter explores the CBRS band in more detail.

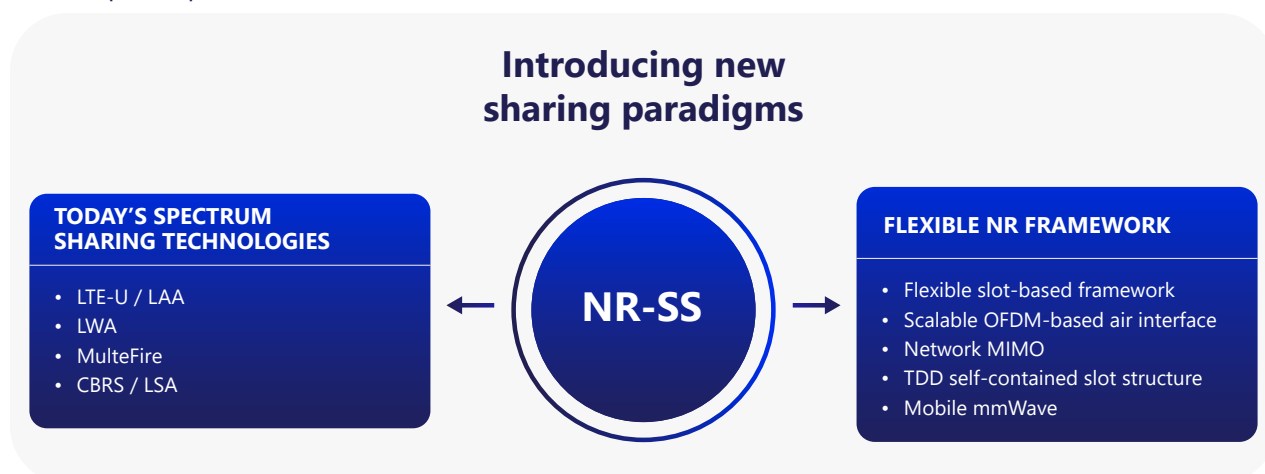

Figure 18: Spectrum Sharing in 5G New Radio Specifications

### 7.1.2 Wi-Fi plus CBRS and Private 5G – how should they best be used?

Approving the US Citizens Broadband Radio Service (CBRS) spectrum was important. The FCC fully opened up the 3,550 MHz to 3,700 MHz band in 2020, paving the way for users to create 5G networks without acquiring the exclusive private spectrum licenses the national MNOs covet.

The Spectrum Access System (SAS) mechanism defined three tiers of usage. The first is the Incumbent Access tier, which contains federal agencies and some grandfathered satellite operators, most notably US Navy radar installations. These are confined to the 3,650-3,700 MHz portion of the CBRS band.

The second tier houses the Priority Access Licenses (PALs), which occupy the 3,550-3,650 MHz range and are awarded through bidding. The third is the General Authorized Access (GAA) tier, which concerns the entire CBRS allocation and allows users to utilize any unallocated portion. However, users are expected to pay ‘reasonable’ fees to the SAS.

<sup>30</sup> <https://www.3gpp.org/specifications-technologies/releases/release-17>

<sup>31</sup> <https://www.mfa-tech.org/2023/01/30/mfa-and-5g-acia-sign-memorandum-of-understanding-to-foster-cooperation-and-synergies-and-advance-global-5g-private-wireless-networks/>

The system frees up a lot of new spectrum for LTE and 5G operations and demonstrates that other regulatory bodies could apply flexible usage rules internationally. CBRS is proving that there are more cost-effective ways to provide spectrum for users to encourage a broader ecosystem of 5G deployments and providers.

It forced a new model on the traditionally exclusive world of licensed MNOs, one more in line with the democratic ecosystem of Wi-Fi. The early users are focused on proving that CBRS deployments can collaborate with Wi-Fi, but there are already calls for more spectrum to be opened up. The CTIA, in the USA, is calling for another 650 MHz of mid-band spectrum, while the DSA is continuing to get regulators to open up 1.2 GHz of spectrum in the 6 GHz band “to achieve the full economic impact of Wi-Fi.”

Academic work is already underway to optimize both Wi-Fi and cellular operations in the CBRS band. An early implementation called ‘multi-armed bandit’ achieved a 33% improvement in the aggregate capacity and throughput for coexisting private LTE and Wi-Fi networks in the CBRS band. Many projects have found promising improvements to be made.

As for the ecosystem, the OnGo Alliance, which is the industry body representing most of these users, says it can be broadly broken into three camps. The first is wireless ISPs (WISPs), which have historically offered Fixed Wireless Access (FWA) services in the CBRS spectrum band and are now converting their licenses to the new rules. Second are the cable companies, which want to expand into mobile services but wish to avoid bidding against the MNOs for those national spectrum licenses. And third, there are the private network operators targeting enterprise deployments.

CBRS deployments allow cable companies and enterprises to move past their existing MVNO agreements, which they rely on for wide-area coverage. These types have had great success offloading most of their mobile traffic onto Wi-Fi, but CBRS-based networks could provide the ability to end their virtual network contracts with the incumbent MNOs. For the likes of Comcast and Charter, which have built significant mobile subscriber bases, CBRS is the logical next step. So, they are vested in ensuring CBRS communications peacefully coexist with their Wi-Fi networks.

For enterprises, there are economies of scale to enjoy. As CBRS makes it easier to deploy a network, the network effects of many enterprises collaborating could be significant – a rising tide that lifts all boats, so to speak. All industries and verticals could be connected by this combination of Wi-Fi and CBRS deployments and leverage the growing capabilities of IoT providers at every stage of the business. Mitigating costs using CBRS, in-housing the costs rather than relying on an MNO, could be transformational for adoption.

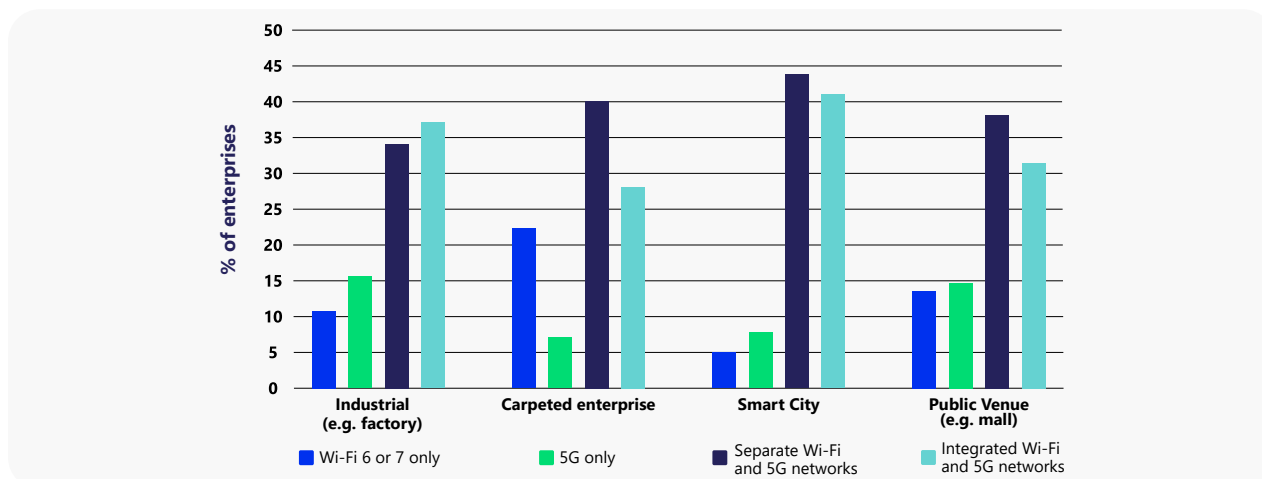

Figure 19: Preferred wireless connectivity strategy 2022-2026

## 7.2 New Role of Wi-Fi in 6G

Given the onslaught of marketers when 5G was coming to market, it would be quite understandable to be wary of the term '6G.' Indeed, 5G monetization has been problematic, with fixed wireless access, the only obvious proven profitable use case currently.

Development is already underway on the sixth and next generation of 3GPP standards, and the usual suspects are at the front of the R&D charge. These are chiefly the infrastructure providers Ericsson, Huawei, Nokia, and Samsung, as well as silicon providers like MediaTek and Qualcomm, and research-driven firms such as InterDigital and Fraunhofer. Crucially, there is currently the expectation that 6G will enable MNOs to adopt different business models, partly enabled by the progress made in 5G and Wi-Fi.

The rationale here is that the flexible licensing for shareable spectrum is a valuable tool, but one that was a distinct departure from the approaches used in 4G and before. It is believed that the 5G lifecycle will allow MNOs to get to grips with the new flexible spectrum, and the network slicing and private network functions that come with it, and so when 6G is finalized and arrives, its native closeness with Wi-Fi should enable a new gilded age.

Because of the complexity of the cellular radio, there are vast categories of connected devices that will rely on Wi-Fi or a simpler alternative for their connection. With 6G advocates stressing seamless interconnectivity, Wi-Fi will be crucial here. Both Nokia and Ericsson discuss an 'Internet of Senses,' and while the long-range cellular radios will still be pivotal for our connected world, Wi-Fi is going to connect most of these new local-area use cases.

Nokia Bell Labs lists six areas that will characterize 6G. The first is AI and Machine Learning, which will be introduced to many parts of the network and its functions. Second, is the new spectrum bands, including both sub-GHz and sub-THz, with 7-20 GHz on the table too. Third is the sensing part, to create networks aware of the world around them.

Fourth is the Ultra-Reliable Low-Latency (URLLC) functions that have begun trickling into 5G, enabling new extremes of connectivity capabilities for device-to-device transmissions with sub-millisecond latency. Fifth concerns new network architectures, building on 5G's first foray into industrial and enterprise environments, and the services-based approach that 5G enables. Finally, new security and trust functions should be natively integrated to protect against DDoS and jamming and protect users' privacy when exploring new mixed-reality worlds.

Of course, it would not be a new 3GPP standard without some outlandish claims of new spectrum bands. Specifically, these are the terahertz band, from 300 GHz to 3,000 GHz. China has made headway in testing the terahertz band in space via a November 2020 satellite launch,<sup>32</sup> and terrestrial labs announced a 1 TB/s transmission using 'vortex millimeter waves' in 2022.

To adopt these new bands, there is an immense amount of latency to tackle in the semiconductor industry. It will be years until such designs are commonplace in smartphones. Still, we can all recall the infamous, possibly apocryphal, Bill Gates quip about 640 KB of memory being enough for everybody.

Wi-Fi will be more tightly integrated with 6G than with 5G due primarily to the convergence of spectrum bands and the associated usage. The existential question for the cellular industry regarding the expectations of 6G is whether it could provide an opportunity to move entirely away from the spectrum paradigm of exclusive national licenses – and into a model that relies more on unlicensed spectrum.

Should this come to pass, co-existence between the cellular and Wi-Fi camps will be critical but should 6G more

<sup>32</sup> <https://www.nokia.com/about-us/newsroom/articles/6g-explained/>

<sup>33</sup> <https://www.ericsson.com/en/6g>

<sup>34</sup> <https://www.mobileworldlive.com/featured-content/home-banner/china-puts-6g-test-satellite-into-orbit/>

<sup>35</sup> <https://www.gizmochina.com/2022/02/14/china-achieve-data-streaming-6g-technology/>

closely integrate Wi-Fi into the standards process, this concern will be nipped in the bud – solved at source, for immense convergence.

### 7.3 Wi-Fi and the Internet of Things

The Internet of Things (IoT) has suffered from over-hyping, with some overzealous evangelists over-promising and under-delivering. However, it has always been clear that Wi-Fi would be a central protocol to the trend's development, as a bridge between the lowest power devices, the coordinating hubs and gateways, and then the rest of the internet.

Given the ubiquity of Wi-Fi in modern life and its relatively low cost compared to long-range cellular options, it is best placed to play a central orchestration role. Here, it is a primary tool to connect hubs to networks to backhaul sensor data and messages from IoT devices that do not have the power budget to feature Wi-Fi.

However, there has been a notable change on this front with the arrival of Wi-Fi HaLow (IEEE 802.11ah, in the past year. First published in 2017, the low-power variant uses the sub-GHZ ISM bands and can achieve much longer ranges than the high-throughput Wi-Fi flavors – up to a kilometer.

Newracom, a fabless semiconductor company, has been developing HaLow products for years. In 2019, it partnered with AdvanWISE to release what it claimed were the world's first HaLow products, based on the NRC7292 SoC, designed by Newracom. The company claimed to launch the first HaLow-powered sensor solution in September 2021, and its latest NRC7394 SoC was unveiled in June 2023.

Vendors still disagree on these firsts, which is typical in emerging markets. The first 'globally available' Wi-Fi Certified HaLow gateway appeared in June 2023. Designed by AsiaRF, it features a Morse Micro MM6108 SoC, for sub-GHz connectivity, and integrates both Bluetooth Low Energy and Zigbee using a MediaTek M7688 system. A month later, Morse Micro's SoC arrived in a module from AzureWave Technologies, again pitched at IoT applications. HaLow is explored in section 6.4.5, as is IEEE 802.11.bf, otherwise known as Wi-Fi Sensing, in section 6.4.2.

Wireless devices are much easier to deploy in challenging environments, compared to wiring in an alternative. The trade-offs are well established, but for industrial environments that might feature hundreds or thousands of such connections, wireless is the best choice. With Wi-Fi HaLow, a true low-power implementation opens the door to a lot more use cases, while the regular high-bandwidth Wi-Fi variants provide enough performance for the latest bleeding-edge use cases.

These include Industry 4.0 and logistics applications that involve autonomous mobile robots (AMRs), automated ground vehicles (AGVs), predictive maintenance and augmented/virtual/mixed reality (AR/VR/MR), which were outlined in the WBA's "[Wi-Fi 6/6E for Industrial IoT: Enabling Wi-Fi Determinism in an IoT World.](#)"

"As more equipment is monitored, wiring becomes prohibitive," the paper says. "Industry is moving towards including wireless technologies to lessen the cost of obtaining more information about their processes. In one recent case in the oil and gas industry, moving to a wireless installation resulted in a 75% cost reduction in installation."

The report includes RF and network deployment guidelines for industrial use cases to help simplify the work of rolling out these critical networks. For example, it recommends leveraging Wi-Fi 6 scheduling to optimize traffic patterns and manage critical QoS requirements.

The enterprise survey referenced above asked specific questions about connectivity for IoT applications. Figure xxx shows that, to an even greater extent than in last year's study, enterprises want to be able to use multiple protocols for the IoT, to address the huge diversity of applications and requirements. But to avoid fragmentation and inefficiency, they stipulate that these must be integrated within a standard management system and potentially a common core.

<sup>36</sup> <https://www.eenewseurope.com/en/first-sub-ghz-wi-fi-certified-halow-gateway-for-the-iot/>

<sup>37</sup> <https://rethinkresearch.biz/articles/Wi-Fi-halow-has-somehow-not-missed-the-iot-boat/>

Source: Rethink Technology Research Enterprise Survey, June 2022

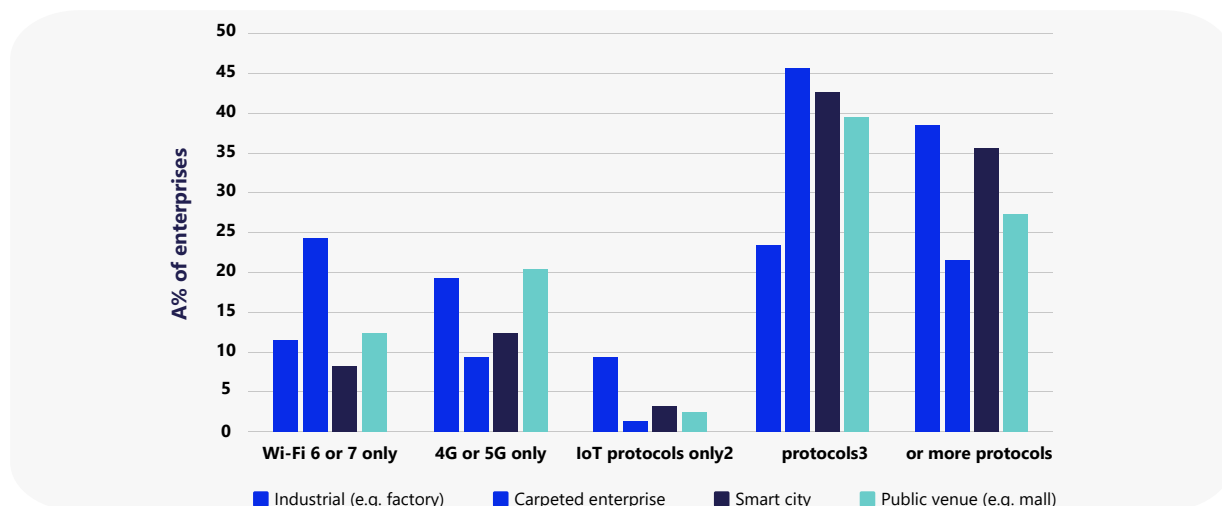

Figure 20: Preferred IoT Connectivity Strategies for enterprises in Selected scenarios

## 7.4 Private LTE aligned with Wi-Fi

There has been an uptick in private network deployments in the past year, with many now using 5G. As of Q2 2023, the GSA reports that some 1,212 organizations have deployed a private mobile network, up from 1,148 in Q1, with 5G being used in 899 and LTE in 899. As such, this is not to say that LTE does not have a role. Still, the arrival of the Reduced Capability Mode (RedCap) opens the door for lower-complexity devices to use RedCap for network applications that do not need the bleeding-edge capabilities of the latest 5G radios.

Many enterprises do not require the ultra-low latency or ultra-dense footprints that 5G enables, so they are happy to use LTE – and will similarly not be tempted to pay a premium for those features they do not need. The gains in market maturity of 5G Standalone (5G SA) have helped adoption, as standalone networks that implement their local network core functions are a crucial selling point. These networks should give enterprises complete control over network performance, rules, security, and resource allocations. However, it is still early days, and there is work to be done for 5G SA adoption.

Much of the previous discussion has focused on the coexistence between Wi-Fi and LTE, not 5G specifically. However, concerns remain about the interplay between the 4G standards and enterprise Wi-Fi networks. The easiest way to ensure Wi-Fi and cellular play nicely together at a base level is to operate them in different license bands. In the US, private cellular will increasingly use the CBRS bands, but elsewhere, they will usually be deployed in separate bands. These can be MNO-owned licenses, enterprise-specific spectrum allocations, or flexible spectrum within the cellular mid-bands, typically between 2.5 and 3.5 GHz.

According to the WBA survey, the primary concern for private network operators and enterprises is the ability to have joint management capabilities for both Wi-Fi and cellular – be that LTE or 5G. The critical requirement or desire here is to control the two networks as a single pool of capacity and coverage. Historically, this was difficult, with vendors catering to one and not both, but the past couple of years have seen progress on this front. For instance, Nokia now supports Wi-Fi and cellular IoT network management within one environment, powered by its Digital Automation Cloud (DAC) offering.

Similarly, the major networking providers have begun expanding their Wi-Fi offerings with private cellular capabilities. At Mobile World Congress 2022, Cisco and HPE launched their private network offerings to provide customers with joint cloud-based command and control features for enterprise networks. At MWC 2023, Cisco ran the show's Wi-Fi network and used it to demonstrate the new WBA OpenRoaming functionality. Also shown were throughput tests for Wi-Fi 6E, with Automated Frequency Coordination (AFC) and ultrawideband (UWB) wayfinding.

<sup>38</sup> <https://gsacom.com/press-release/5gacia-and-ongoalliance-join-gsa-pmn-sig/>

<sup>40</sup> <https://blogs.cisco.com/networking/cisco-paves-the-way-for-the-future-of-wi-fi-at-mwc-barcelona-2023>

<sup>39</sup> <https://www.dac.nokia.com/connectivity-solutions/multefire/>

## 8. Spectrum and Regulatory

The advent of a flexible and shared-use spectrum has brought Wi-Fi and cellular closer together. Both 4G and 5G now support operations in unlicensed bands. While Wi-Fi benefited from the opening up of the 6 GHz band, those in the cellular camp are still looking for additional capacity. In turn, changes to previously licensed or restricted bands to support more unlicensed operations are being viewed by those in the cellular game as a point of concern.

Consequently, regulators are attempting to open up more spectrum to keep all camps happy. Policymakers generally agree that the best way to avoid conflict is to ensure plenty of spectrum to go around – enough to support both ecosystems.

This blurs the historical line between the fully licensed cellular spectrum and the unlicensed free-for-all that Wi-Fi had to battle. Unsurprisingly, there are differences of opinion on how best to balance these concerns. Still, progress has been towards a plentiful spectrum to support any combination of technologies and business models.

### 8.1 6 GHz Extension for Wi-Fi

With Wi-Fi 6E, Wi-Fi could use the 6 GHz band, which ranges from 5,925 MHz to 7,125 MHz. The US FCC decided to open the entire band for Wi-Fi in 2020, putting pressure on European regulators to do the same.

All European countries have now adopted the lower half of the 6 GHz band, with most of the major markets considering adopting the upper half. Most Latin America has adopted the entirety of the band due to its closeness to the FCC regulations. Progress in 6 GHz adoption in Asia Pacific has been very slow, but the same can be said of the Middle East and Africa (MEA). The Wi-Fi Alliance lists the state of 6 GHz adoption, available [here](#).

Wi-Fi 7 will make use of the 6 GHz band too. Wi-Fi 6E saw a massive uplift in capacity due to the additional fourteen 80 MHz channels and seven 160 MHz channels gained with the 6 GHz band. For context, these provided more capacity than the 2.4 GHz and 5.8 GHz bands.

The broader channels simplify network designs and communication, reducing congestion and removing the need to support legacy devices in those channels, further simplifying matters. To this end, the improved performance means that Wi-Fi 6E can compete with 5G in the most advanced emerging use cases in ways that previous generations could not. These include industrial and enterprise VR and metaverse functions, various Industry 4.0 applications, and potential automotive ones.

The Radio Spectrum Policy Group (RSPG) has been advising the European Commission on opening up the rest of the 6 GHz band in its World Radio Conference (WRC). The RSPG has been collecting stakeholder opinions on the move, and recently, the International Mobile Telecommunications (IMT) community has begun calling for at least some of that upper 6 GHz band to be dedicated to licensed 5G applications. The 2023 WRC takes place in Dubai and will run from November to December.

The preparatory meeting report has the upper 6GHz band on the agenda, as item 1.2, alongside several other alternatives. The proposal is to designate the upper 6 GHz band as a Region 1 (Europe and the Middle East and Africa) IMT band, which would be detrimental to Wi-Fi. Most advocates.

The 7025-7125 MHz band is being discussed as a global option for all three regions. Some national regulators have published their positions on the proposals, and the UK's Ofcom paper outlines the issue well. Ofcom

<sup>41</sup> [https://www.itu.int/dms\\_pub/itu-r/opb/act/R-ACT-CPM-2023-PDF-E.pdf](https://www.itu.int/dms_pub/itu-r/opb/act/R-ACT-CPM-2023-PDF-E.pdf)

<sup>42</sup> [https://www.ofcom.org.uk/\\_data/assets/pdf\\_file/0028/248770/update-on-upper-6hz-band.pdf](https://www.ofcom.org.uk/_data/assets/pdf_file/0028/248770/update-on-upper-6hz-band.pdf)

<sup>43</sup> <https://www.gsma.com/spectrum/wp-content/uploads/2022/08/6-GHz-IMT-Ecosystem.pdf>

<sup>44</sup> [https://www.wi-fi.org/downloads-registered-guest/6\\_GHz\\_Wi-Fi\\_Connecting\\_to\\_the\\_future\\_202210.pdf/38765](https://www.wi-fi.org/downloads-registered-guest/6_GHz_Wi-Fi_Connecting_to_the_future_202210.pdf/38765)

favors a 'no change' outcome, leaving the upper 6 GHz band open for Wi-Fi.

The GSMA has published a paper arguing this case, while the Wi-Fi Alliance has countered, arguing that "5G/IMT deployments in the 6 GHz band are not feasible." As such, there is still great uncertainty that Europe will open up the upper half of the 6 GHz band, and as mentioned in section 7.1, there has been a slow uptake in Asia Pacific and the Middle East and Africa.

## 8.2 Coordinated Shared Spectrum Models

Regulatory attention has been focused on coordinated spectrum-sharing models, due to the aforementioned debate. Regulators are generally aware that the growing diversity of business models and use cases necessitates more spectrum availability and are attempting to find a middle ground – between the cost and associated barriers in licensed spectrum versus the fear of potential congestion in unlicensed spectrum.

Much spectrum management and assignment will be integrated into an automation and orchestration layer in virtualized networks. This will have a new level of dynamic capabilities for coordinating all the different virtualized access networks and supporting network slicing.

Several distinct technological steps are already being taken along this path. The first and most prominent is Automatic Frequency Selection (AFS), and the associated technology of Dynamic Frequency Selection (DFS), to avoid interfering with incumbent users, such as military radar installations. These are methods of automatically determining the best connection option, be it cellular or Wi-Fi. AFS is at the heart of spectrum access systems, which manage access priority in CBRS and similar schemes.

## 8.3 Automated Frequency Coordination

The 6 GHz band does have some incumbent operators, which were in place before the FCC decided to open up the entire band. These include military radar installations, microwave links for MNO backhaul, some utility networks, and public safety and transportation.

As such, there must be a mechanism to ensure these incumbent operators are not interfered with. The best working example is found in the CBRS band, but these AFC functions ensure that different tiers of usage can be managed in the same band without interfering with each other or the established incumbents.

An AFC is likely only needed for high-power transmissions. The chance of these interfering with a high-power incumbent transmission or a paid-for prioritization is low for indoor and low-power transmissions. The AFC database contains allocations and rules to determine which users can use which channels, at what times, and what output powers.

The Open AFC Software project is a dedicated open-source community within the Telecom Infra Project (TIP), attempting to design and develop AFC software for unlicensed services in the 6 GHz band. There are more than 30 participant companies in the Open AFC Working Group, and it seeks to provide an open-source repository that can be modified to suit the varying market and regulatory requirements.

Open AFC can play an important role here by developing the reference implementation of an AFC system. By assisting the development of OpenRoaming, which also includes automatic friction-free onboarding, the public will receive the full benefits of 6 GHz Wi-Fi, with privacy and security.

The graphic below illustrates the complete 6GHz AFC architecture to contextualize the position and role of an AFC system integrating Open AFC Software.

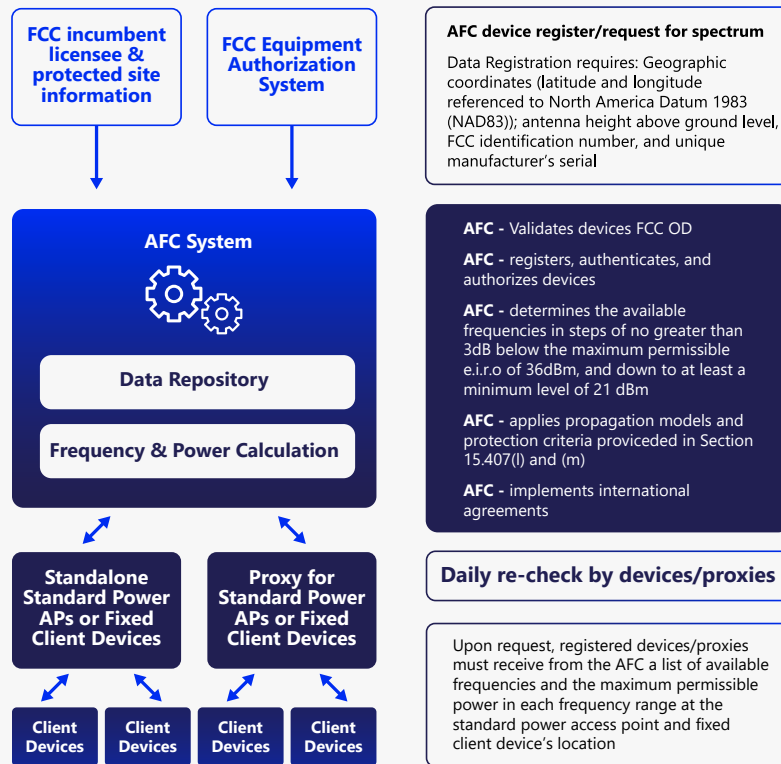

Figure 21: Role of Open AFC Software

The Telecom Infra Project's OpenWiFi group adopted the WBA OpenRoaming standard in May 2021, which enabled users to securely roam between locations without requiring new registrations and logins. The WBA is collaborating with the TIP to define how Open AFC will work, and how public and guest Wi-Fi based on OpenRoaming will benefit from the full range of Wi-Fi 6E capabilities.

In late 2021, fourteen companies and organizations filed with the FCC to become AFC System Operators – explained in further detail in section 5.6. This would enable them to operate AFC functions in the US, and five of them applied with the intention of using Open AFC systems for the service. Notably, trade organizations were part of this group – including the Wi-Fi Alliance, the Wireless Broadband Alliance, and Kyrio (the commercial services arm of CableLabs).

While it was initially thought that AFC operations for Wi-Fi in the end might be exclusively run by companies already specialized in spectrum management—such as companies operating SaaS platforms for CBRS—the sentiment towards AFC and the road ahead now looks entirely different. Operating an AFC system as a profitable commercial service seems less likely. However, non-profit AFC operations—possibly membership-based to cover costs—seem most probable. There is still considerable debate as to their efficacy, however.



Given the importance and complexity of the work still, ahead of AFC, the WBA is certifying an AFC system with FCC based on Open AFC and open to present candidatures globally.

## 8.4 Regulatory & Spectrum Framework for 5G with Unlicensed Bands

In recent years, there has been a significant reduction in the fear of potential conflicts between cellular and Wi-Fi in unlicensed bands. Both the Wi-Fi and cellular communities have focused more on coexistence than disputes. However, uptake of cellular networks using License-Assisted Access in the 5 GHz band has been slower than expected – using a combination of licensed and unlicensed to boost speeds.

However, this period of peace may come to a close, as the cellular crowd, via the GSMA, is calling for some of the 6 GHz bands to be assigned for licensed use. Adopting the 5G New Radio Unlicensed (5G NRu) will intensify this pressure once cellular advocates have a native unlicensed option for communication – and not one that was grafted on after development started, as in 4G. The 5G NRu is discussed in more detail in an earlier chapter.

The cellular community contends that standalone NR-U has been designed from the ground up to coexist fairly with other unlicensed technologies, including LTE-LAA and Wi-Fi. But anxieties persist, though the industry is working hard to allay them. For instance, the IEEE published a paper in January 2021 proposing a new method of handling collisions that has been shown to improve performance for both 5G and Wi-Fi, especially the latter.

The IEEE has also been increasingly focused on coexistence with 5G in cooperation with ETSI. Its 802.11 Coexistence SC focused on the ETSI EN 301 893 coexistence requirements initially set out in 2017, and a new version was under development in 2021. Current work items include coexistence challenges for the Wi-Fi 7 (802.11be) standard and expanding the project scope to a 60GHz unlicensed spectrum.

## 9. WBA Programs and Projects — 2023/2024



Figure 22: Technical Activities Roadmap for 2023

### 9.1 The Rise of WBA OpenRoaming

#### Technical Standard - Release 4

The past year has been a remarkable period of growth for OpenRoaming, marked by significant advancements in deployments and global adoption. This growth extends to network providers, identity providers, and AP manufacturers, with the latter now integrating OpenRoaming products and enabling a simple ‘checkbox’ option on their equipment. This checkbox activates OpenRoaming’s dynamic peer discovery (DPD), the critical component that enables the 1-to-many characteristic relationship of OpenRoaming.

In particular, the Technical Standards team has been focused on leveraging multiple API tools that will enable implementers ease of access to the WBA database, implementing custom-QOS and moving networks policies to respect the unicity of some particular types of networks, and developing liaison work with 3GPP and IETF namely to advocate OpenRoaming and build the platform for the converge with Private 5G.

Looking ahead, OpenRoaming Release 4, complete with all the new advancements, is scheduled for a fall 2023 release. The progress in 2024 will maintain its focus on the convergence of Private 5G and IoT.

### 9.2 Wi-Fi 7 Advocation & Trials

WBA members have started in 2023 the advocation work on Wi-Fi 7, while device availability was promised to

later stages of the year and the certification was still in progress.

With 16 WBA member organizations contributing to the effort, the members have launched a first deliverable called 'Get Ready for Wi-Fi 7' showcasing what the industry can expect from the technology, in terms of its applications but mostly the new use cases that can be explore.

The document includes a relevant description and categorization of key Wi-Fi 7 features namely SLA Management, Link Aggregation/Diversity (MLO), Speeds & Spectrum and Emergency Services.

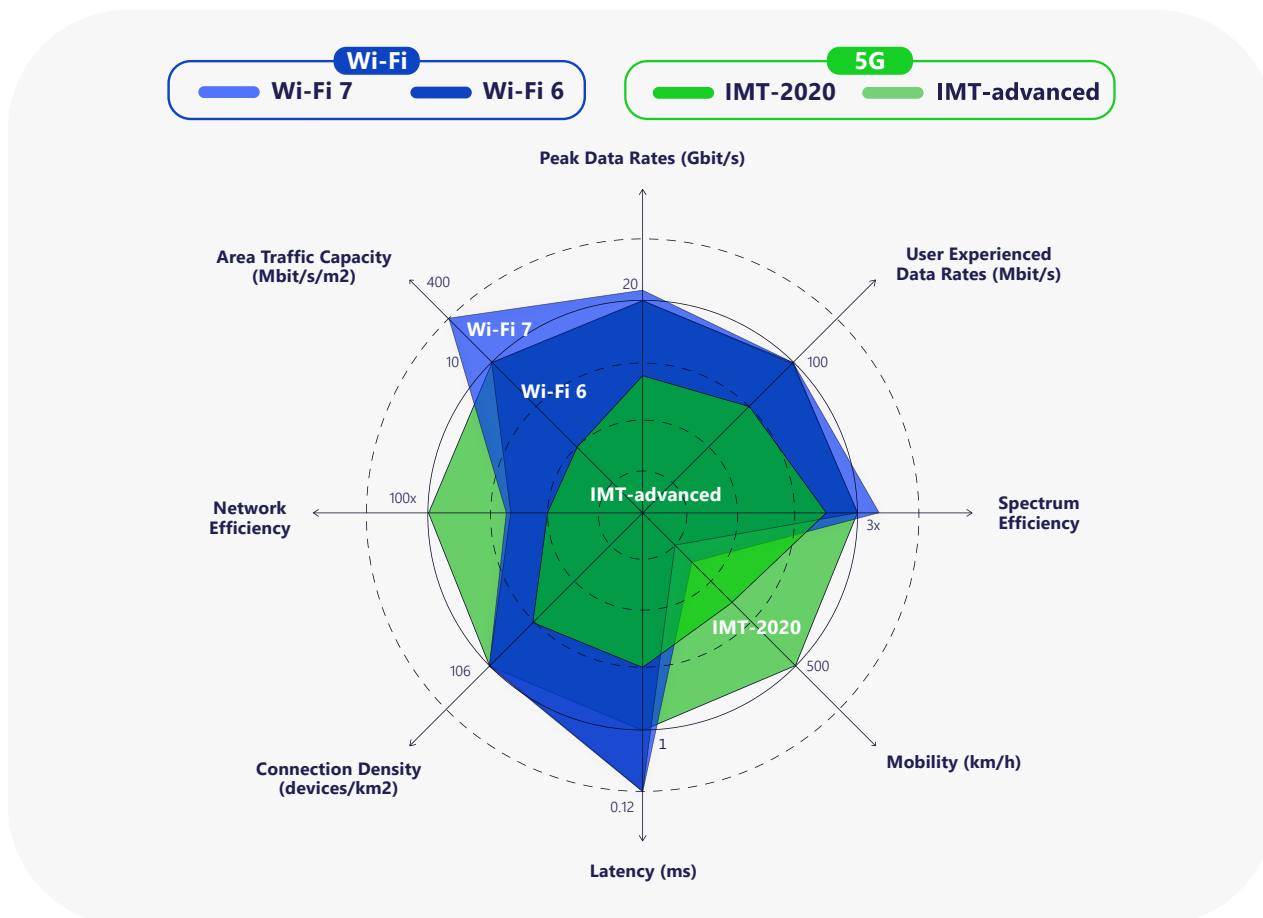

Figure 23: Capabilities of latest Wi-Fi (6/6E/7) and IMT generations (IMT-Advanced (4G) and IMT-2020 (5G))

The team is now assembling the platform for initiating live trials as some devices are already available in the industry, pre-certification, and is planning to debut the trials officially in 2024.

### 9.3 Operator Managed Wi-Fi (OMWi) – Reference Architecture

The OMWi project was launched in 2023 with the release of the 1st Phase of the OMWi Reference Architecture. WBA is now setting their sights on incorporating additional, more advanced features into the architecture.

The project group organized a series of technical demonstrations, offering a comprehensive view of various facets of the architecture. These included network configuration, northbound API modeling, a virtual BSS solution, among others. Notably, Airties, MaxLinear, CableLabs, and CommScope were the companies behind these demonstrations, all of which adhered to WBA’s Reference Architecture for OMWi.

Phase 2 of OMWi is currently in the final stages of refining the technical specifications for Phase 2 features and is on track to release this exciting update by early 2024. Phase 3 will integrate IoT and Passpoint-OpenRoaming

elements. Within the WBA, a dedicated team is actively engaged to develop a Smart Home Reference Architecture that will provide valuable input to the OMWi team. Additionally, there is a fresh program proposal centered on OpenRoaming for Residential Networks in the works. Both of these initiatives are anticipated to bolster the overarching OMWi architecture as a cohesive and unified framework.

## 9.4 5G and Wi-Fi Convergence

Building on the commitment from the previous year, the WBA Private 5G & Wi-Fi Convergence work group has dedicated this year to advancing core technical elements. These components are of paramount importance in delivering a viable solution to the industry and in attaining operational convergence between the two radio access technologies, namely Private 5G and Wi-Fi.

Technical components involve fast transition, singular authentication, cryptographically generated identities, IP persistence, spectrum efficiency, QoS convergence, amongst others, some of these that needed to be liaised with other industry bodies in order to achieve standardization on the cellular architecture and RADIUS attributes.

## 9.5 Improving Wi-Fi Experience in Moving Networks

The 'Moving Networks' program within WBA represents a natural extension of previous efforts for In-Flight Connectivity, now expanding its reach to encompass maritime, bus, and vehicular transportation. The challenges are similar across these diverse sectors, the demand for uninterrupted connectivity, the imperative to prevent disruptions, the requirement for high-quality signals, and the necessity for efficient roaming options persist.

The team has been laying out the foundations for addressing these challenges, outlining use cases and mapping network flows that will serve as recommendation to the industry. Crucially, the team is working actively towards conducting a real live trial during the upcoming months, utilizing a moving venue. The plan is to commence with a maritime scenario, with aviation as a potential future endeavor.

Solutions presented to tackle local authentication and prevent network disruptions, along with the incorporation of Roaming components based on Passpoint-OpenRoaming technology, which play pivotal roles in shaping the overall design of the proposal.

## 9.6 IoT & Smart Home

Over the past couple of years, the concept of Smart Home has been discussed and revisited. Taking inspiration from the upcoming Matter protocol developed by the CSA, WBA members decided to initiate a technical program to develop a Smart Home Reference Architecture. This architecture will be based on the different types of Radio Access Technologies (RATs), such as Wi-Fi, Thread and other IoT technologies and create technical layers for interconnection and services on top of those, namely using Matter protocol.

While the project is still in its initial phases, it benefits from a robust collaborative platform involving industry peers. The aim is to provide significant input for the WBA Operator Managed Wi-Fi Reference Architecture, as mentioned in 9.3.

## 9.7 Access Network Metrics (QoE) and E2E Wi-Fi QoS

WBA carries on developing important work in the domains of Quality of Service (QoS) and Quality of Experience (QoE).

The E2E Wi-Fi QoS group has launched a first guide to the industry highlighting the advantages and technical capabilities of QoS Management Stream Classification Services (SCS) tags for traffic management and prioritization. Moreover, through close collaboration with industry counterparts, the group is actively crafting a test plan for forthcoming trials.

Access Network Metrics will launch the first industry framework that will outline the near-real time performance metrics that the group recommends for monitoring network status, including performance and healthiness. Looking ahead, this group will continue its efforts in 2024, focusing on development of streaming mechanisms for identity providers.

## 9.8 Venue Requirements for User Engagement

The program was initiated in 2023 with the objective of assisting venue owners and network implementers in transitioning from a user captive-based flow to an automatic and secure authentication using Passpoint & OpenRoaming technology. This program carries a distinctive focus: it aims to retain engagement touchpoints with the end-users through latest Passpoint features.

The group is about to launch the core assessment study to the industry with the technical recommendations and gap analysis. The report is written not only from a technical angle but also incorporates business cases and monetization options, oriented to the technical directors who ultimately can take the decision to move one step further in their overall experience.

This technical program's goal is to exert influence within the industry. This influence extends not only to future programs within WBA but also to industry peers. Its purpose is to address the experience gaps that are building blocks for a Passpoint adoption in the world.

## 9.9 Wi-Fi HaLow for IoT Applications

Wi-Fi HaLow, based on the IEEE's 802.11ah standard, is a Wi-Fi-based technology using the spectrum below the 1GHz band wave to address the long range, low power needs, particularly in the domains of IoT, encompassing applications such as smart cities, utilities, etc., with a broad range of applications.

Within WBA, a new initiative has taken shape this year. The first phase involves deliverables for various verticals, use cases and technical capabilities of the HaLow technology. The second phase is geared towards conducting real live trials. Currently, the team is in the midst of collaborative efforts to coordinate these trials across multiple locations and venues in United States. The team aims to compile a performance report detailing the achieved results for the industry's benefit.

## 10. Sustainability and World Wi-Fi Day — Charter and Progress

Much progress has been made since the WBA launched the HOPE for Connectivity charter for [World Wi-Fi Day](#) in 2016. At that time, there were 3.4 billion internet users, a penetration of 46.1%. Since then, the world has added almost 2 billion internet users to reach almost 5.4 billion.

While this progress is remarkable, billions of unconnected citizens are still in developing and rural areas. Wi-Fi can do a tremendous amount of good and help humans thrive and achieve things that once seemed impossible, Wi-Fi is the great equalizer to bridge the digital divide. So, the work must go on to make the 5th utility - i.e., Wi-Fi - accessible to everyone.

As a reminder, World Wi-Fi Day takes place on June 20th each year and is a global initiative to help bridge the digital divide. This day is designed to recognize and celebrate Wi-Fi's significant role in cities and communities worldwide through innovative projects that "connect the unconnected."

The HOPE for Connectivity charter directs the attention of cities, government bodies, fixed and mobile operators, technology vendors, and internet giants toward wireless connectivity's critical influence and success in bridging the digital divide. It calls on governments, industry, and the public to recognize and celebrate the vital role of Wi-Fi in socioeconomic development and to advance and accelerate affordable connectivity for the unconnected worldwide.

The HOPE for Connectivity charter focuses on four key themes :

- Help: fund Wi-Fi deployments to connect unconnected communities around the world
- Offer: affordable Wi-Fi access to unconnected communities in rural and urban areas
- Promote: the success of Wi-Fi in connecting cities and communities
- Engage: recognize the function of Wi-Fi to address the digital divide

Access to the Internet provides people in developed and developing countries the opportunity to increase their economic growth, improve their social mobility and computer literacy, and enrich their education prospects. In 2023 the US federal government formally recognized World Wi-Fi Day as part of the official US Calendar.

<sup>45</sup> <https://www.internetlivestats.com/internet-users/#trend>

<sup>46</sup> <https://wballiance.com/world-wi-fi-day-about/#wwdfactsandstats>

<sup>47</sup> <https://wballiance.com/world-wi-fi-day-about/>

## 11. Industry Survey — Findings, Summary, and Implications

The WBA’s annual survey of Wi-Fi stakeholders continues to provide important indicators for the state of the market, and the industry’s perspective on new developments. With 196 respondents, this year saw a significant increase on last year’s 155. North America was the largest region, in terms of responses, with 44.9% of respondents, followed by EMEA (21.4%), APAC (18.4%), South America (6.6%), the Middle East (4.6%), and Africa (4.1%).

The respondents report that they are increasingly confident in their Wi-Fi investments, with 57.9% saying they are more confident now than they were a year ago. Last year, the same question netted a score of some 46%, and there has been a significant drop in the number who said there had been no change – from 28% last year to 18.5% this year. As for respondents who felt they were less confident, there has been effectively no change in the past year – with the current score at 21.3%.

### How was your confidence towards investing in Wi-Fi changed over the last 12 months?

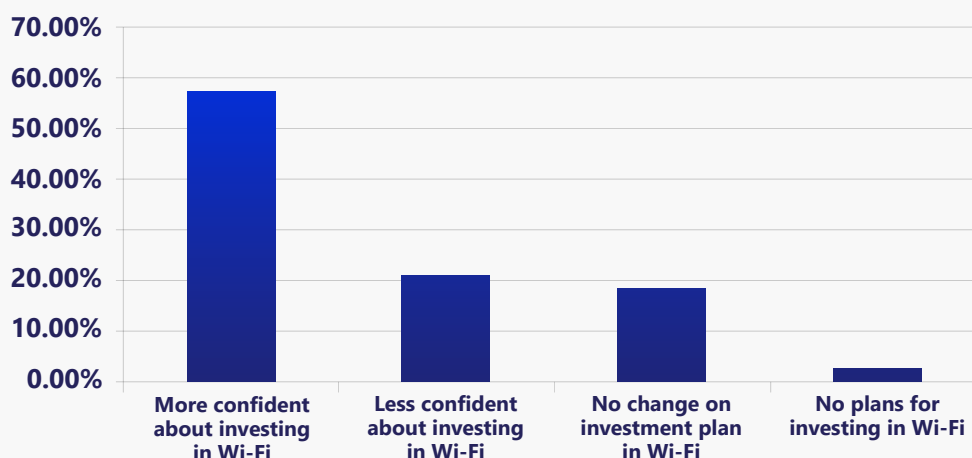

Figure 24: How was your confidence towards investing in Wi-Fi changed over the last 12 months?

There has been progress on respondents’ plans to deploy Passpoint and/or OpenRoaming, up from 62% last year to just under 68% this year. However, this was a much smaller increase than was seen last year, where the rate leapt from 40% to the aforementioned 62%. Just over 20% say they do not have a plan to deploy, with just under 12% saying the question was not applicable.

As for the most important drivers for investing into a Passpoint or OpenRoaming network, seamless access between Wi-Fi and 5G or LTE remained the highest requirement, at 43.1%, followed very closely by frictionless access to Wi-Fi, at 42.2%. Joint third place went to enabling seamless access across different networks, and to provide improved security on Wi-Fi networks, with 37.1%.

Notably, far fewer respondents answered the inverse to this question – reasons not to invest. Of those that did, the lack of expertise was the leading factor, at 31%, followed by a lack of partners to support the deployment, at 28.6%, with the other joint second place being uncertainty on the business models. Joint third, on 26.2%, pointed a lack of resources, and too much complexity or not understanding the benefits of Passpoint and/or OpenRoaming.

## Please select the TOP 3 drivers for investing in a Passpoint and/or OpenRoaming™ compliant network.

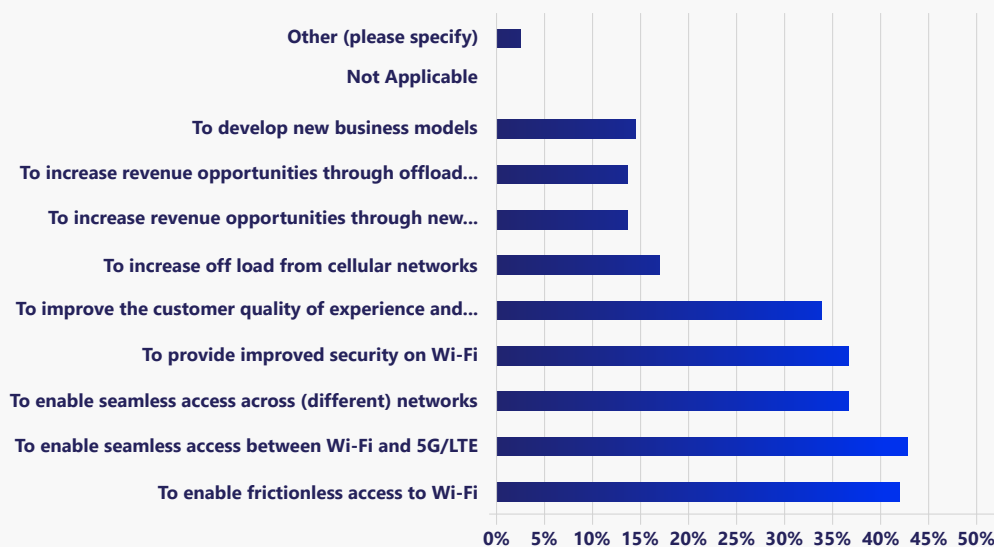

Figure 25: Top 3 drivers for investing in a Passpoint and/or OpenRoaming™ compliant network.

When asked which points were the most important to their business, the most popular answer among respondents was the end user experience, scoring 89.5%. Monetizing Wi-Fi services was second, with 79.6%, followed by seamless authentication, with 74.5%. The Internet of Things (IoT) was the lowest score, but with a 50% response rate, there is clear interest in the trend from our respondents.

There was considerably less clarity on the question of which future applications will drive network and traffic growth, however. The most popular answer here, however, was the IoT, with 35.6%, followed by Artificial Intelligence (AI), on 32.6%, and Private Networking with 5G and Wi-Fi in third, with 27.4%. The lowest response was Gaming, at just 11.1%.

For the new technologies most likely to be deployed by our respondents, Wi-Fi 6 or 6E was an unsurprising first place, scoring 41.1%. There was a considerable gap to second place, which was Distributed Antenna Systems (DAS), at 23.2%, just ahead of third-placed Private Cellular, with 22.9%.

When asked what the most important new or improved features for Wi-Fi 6E or Wi-Fi 7, both transmission scheduling and multi-user MIMO uplink scored 31.9% - the highest response. Just behind, in second place, was peak speeds, at 31.1%, showing that throughput is still a very important consideration. Third place went to OFDMA, in both uplink and downlink, on 30.4%.



## For Wi-Fi 6E or Wi-Fi 7, what do you consider to be the 3 most important new and improved features?

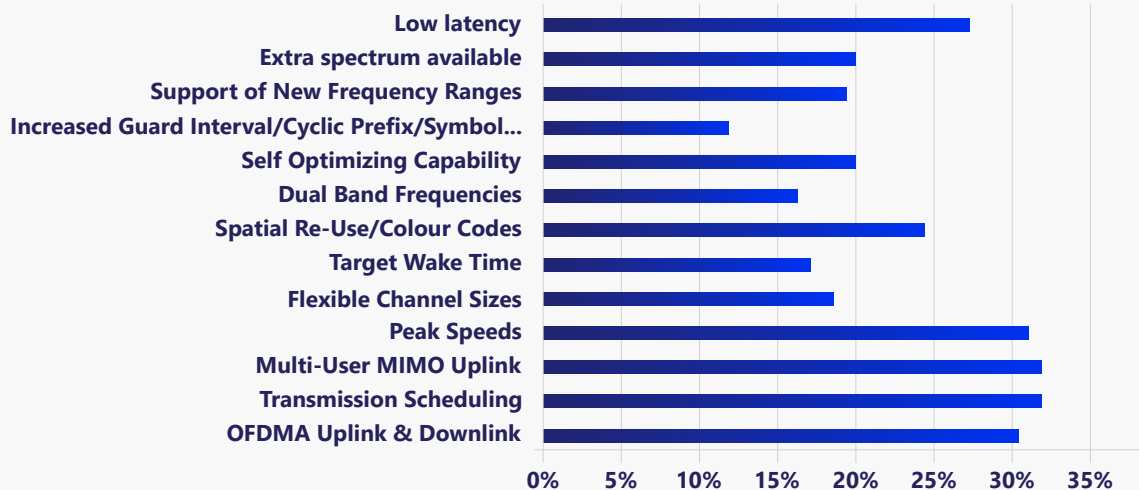

Figure 26: 3 most important and new improved features for Wi-Fi 6 or Wi-Fi 7.

On the matter of 6 GHz spectrum availability, 42.2% of our respondents said it was important, with 25.9% rating it as somewhat important. Some 8.9% rated it as not important, with 3% saying the question was not applicable. However, a full 20% said it was critical to their business.

A full 81.5% of respondents provided or supported Wi-Fi in consumer homes, with 50% supporting community Wi-Fi value-add, 48.1% supporting managed Wi-Fi services, and 45.2% supporting cellular offload or neutral host in community Wi-Fi deployments. Just 21.2% supported QoE and/or QoS – the lowest score among respondents.

As for in-home concerns, the major gaps reported by respondents are QoS (on 51%, despite its low presence in the previous question), delivering services over Wi-Fi Easy Mesh or Multi-AP architectures (41%), and end-to-end security (39%).

## What are your major gaps for delivering In-Home Wi-Fi services in line with customer expectations?

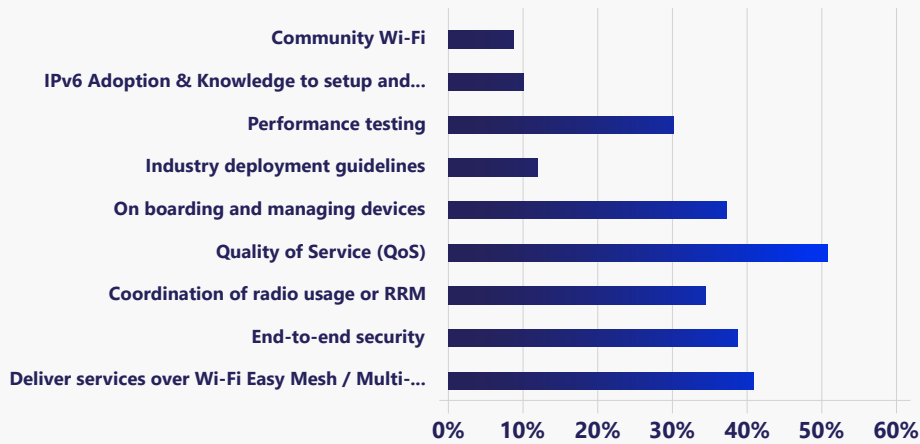

Figure 27: Major gaps for delivering In-Home Wi-Fi services in line with customer expectations?

The top-three most important target verticals were Education/Campus (42.5%), Network Operators or Service Providers (37.2%), and Hospitality (34.5%). Joint-last were Aviation and Connected Vehicle, on 15%, with Government or Smart Cities scoring 37.2%.

As for the future-looking growth, shopping malls or Retail was the most popular response, scoring 41.6%, with Transportation Hubs taking second, at some 35.4%, followed by Smart Cities with 31% - just ahead of Stadiums or Events Venues (30.1%). That smart cities are off the pace in most important verticals, while being one of the biggest growth expectations, is notable.

## Please select TOP 3 areas where you expect to see the greatest growth in terms of traffic in the next 12 months.

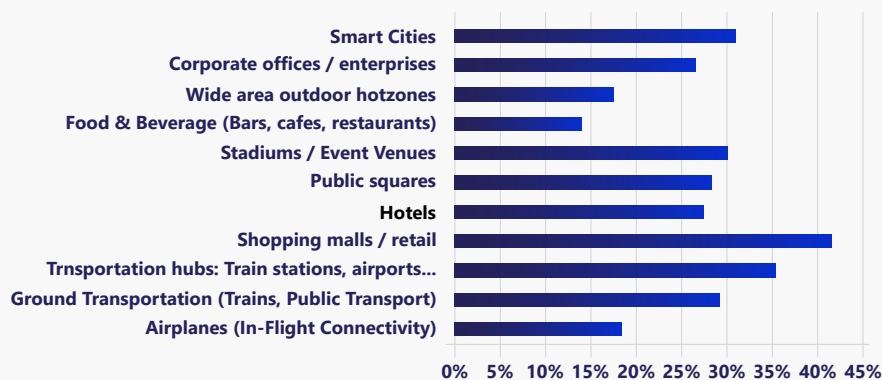

Figure 28: Top 3 areas where you expect to see the greatest growth in terms of traffic in the next 12 months.

The business model (55.8%) remains the most popular response to the question of the key challenge when

deploying new services. This is a long way ahead of second-placed QoE (46%), which in turn is a good chunk clear of third-placed QoS (35.4%).

With 81.5% of respondents answering that they were involved in in-home networks, it is notable that 69.7% said they were either involved or planning to be involved in a city-wide public Wi-Fi deployment. Breaking this down, 34.7% had already implemented, with an equal 28% saying they were deploying in 2023/2024 or 2025. Some 8% were targeting 2026 and beyond, with just 1.3% saying they did not know.

The top challenges for deploying public Wi-Fi networks were the business model and monetization strategies (69%), followed by opex (55.4%) and then capex (50%). The next cluster saw a lack of internal expertise and technologies both scored 35.1%, with public expectations scoring 33.8%.

## 12. Case Studies

### 12.1 OpenRoaming Takes Center Stage in Tokyo

The Tokyo Metropolitan Government (TMG) is the government of the Tokyo Metropolis. One of the 47 prefectures of Japan, the government consists of a popularly elected governor and assembly. The metropolitan government administers the special wards, cities, towns, and villages that constitute part of the Tokyo Metropolis. With a population closing in on 14 million living within its boundaries and many more commuting from neighboring prefectures, the metropolitan government wields significant political power within Japan.

The TMG announced the Tokyo highway data strategy in 2020 with a vision to connect anyone anywhere in the city with mobile broadband, whether residents or tourists, to enhance their quality of living.

As more international travel to and from Japan is expected, free Wi-Fi is in demand as an easy means for travelers to communicate in a secure environment. However, traditional free Wi-Fi often lacks encryption between the device and access point, posing security challenges such as difficulty suppressing connections to fake access points.

TMG analyzed the best route to materialize this vision and decided to adopt OpenRoaming after carefully reviewing similar large-scale deployments of OpenRoaming, including LinkNYC, eduroam, and Cityroam.

To enable the Tokyo highway data strategy, two main problems had to be solved: convenience and security. OpenRoaming solves both by providing a secure and seamless onboarding experience. Anyone can safely and automatically connect to domestic and international free Wi-Fi that supports OpenRoaming by simply registering once through a QR code or app displayed in the area. This eliminates the need for registration at Wi-Fi spots and reduces the risk of personal information being stolen by fake access points.

The vision became a reality for the strategic partnership between TMG, KDDI, and Wi2 announced in March 2023.

Wire and Wireless Co., Ltd (Wi2), a subsidiary of KDDI, is a wireless broadband service operator focusing on Wi-Fi service under the “Wi2 300” and “GIGAZO” brand. Wi2 has deployed over 100,000 hotspots across Japan, enabling the OpenRoaming initiative to reach critical mass.

Wi2 infrastructure is used by more than 100 local governments and more than 150 public transportation systems nationwide. Hotspots have also been deployed in cafes/restaurants, retail stores, public facilities, hospitality, offices, schools, and more.

The Tokyo Metropolitan Government has contracted both companies to develop and operate the “TOKYO FREE Wi-Fi” (<https://wi-fi.metro.tokyo.lg.jp>) service environment using OpenRoaming, which began operation on March 31, 2023.

In March 2023, a trial was conducted at the pre-registration counter and gate near the starting point of the Tokyo Marathon 2023 utilizing this OpenRoaming platform. Wi2 received feedback from runners from overseas who said they could easily connect to Wi-Fi and confirm their identity through the app. As of April 2023, 26 locations became live (Nishi-Shinjuku Smart Pole, TMG office, travel information center etc.).

Wi2 demonstrated utilizing satellite communication Starlink and network slicing through 5G SA to provide stable Wi-Fi during network congestion at certain spots. It confirmed that it is possible to secure wireless communication capacity in crowded environments.

The partners involved in the project built an online platform to manage the OpenRoaming infrastructure and users. The platform includes a mechanism to verify the legitimacy of access points with electronic certificates, preventing users from connecting to fake access points. In addition, wireless communication channels are encrypted with different keys for each user to prevent eavesdropping. The physical network also supports the

6GHz band (Wi-Fi6E), which became available in Japan in September 2022 and strives to provide speeds of up to 2.4Gbps. (The service is provided in some initial project service areas commissioned by the Tokyo Metropolitan Government.)

Various identity providers are used for user authentication, including Line, Japan’s most popular chat application, while google and Apple ID are also supported.

The platform supports major operating systems (iOS, Android, Windows, macOS) and registrations in multiple languages, including Japanese, English, Simplified Chinese, Traditional Chinese, and Korean.

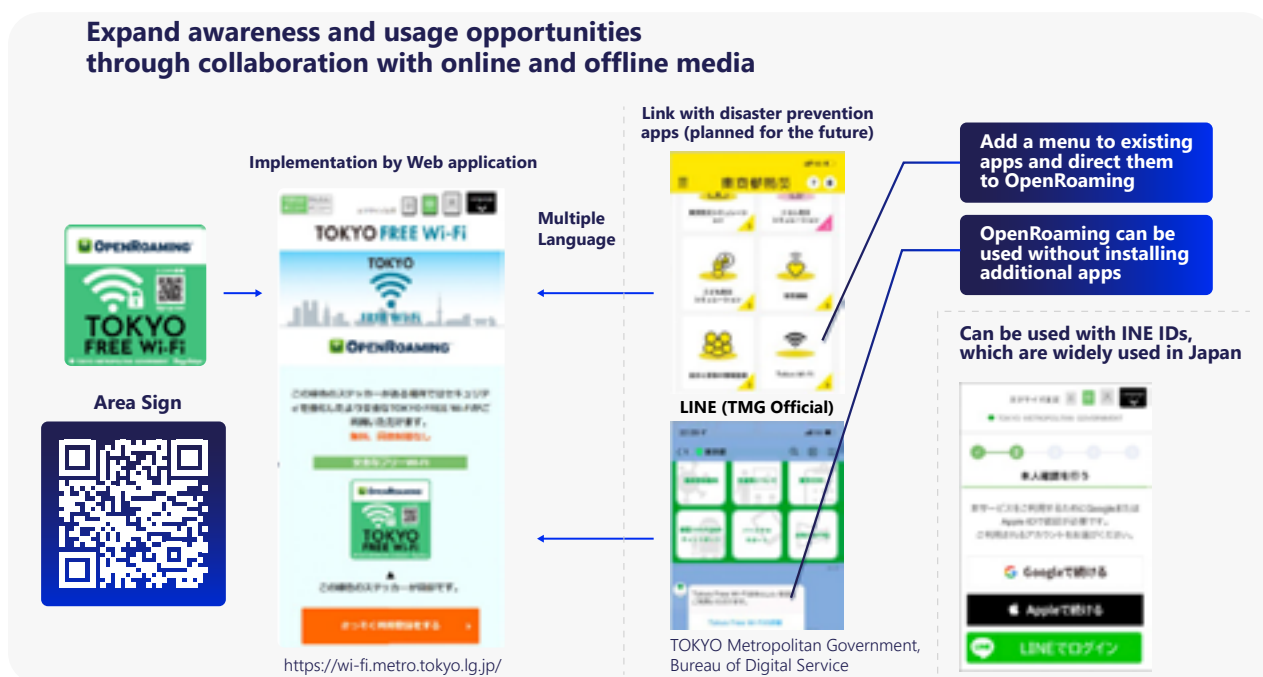

Figure 29: Expand awareness and usage opportunities through collaboration with online and offline media.

A customer support desk is available by phone and email (in Japanese and English) to ensure users can easily connect. Additionally, the initial setup system is compatible with collaboration with local government apps and official SNS accounts, allowing for the integration of Wi-Fi connectivity into various media. OpenRoaming is automatically activated when government disaster applications are used or select tourist applications are initiated.

In addition, by combining KDDI Group’s diverse access lines, including fiber-optic lines, 5G, and satellite, OpenRoaming will become part of the regional network.

Promoting to educate users about OpenRoaming has been quite effective with offline and online marketing strategies. The TMG is also participating in the success of OpenRoaming by encouraging municipalities and private companies to implement it. By March 2024, about 600 new locations (ex. Metropolitan High schools, metropolitan facilities etc.) will be added to the network.

KDDI and Wi2 have started offering the first OpenRoaming compatible app update in Japanese for “au Wi-Fi access,” jointly provided by both companies, through the App Store and Google Play starting in March 2023. This aims to provide information tailored to the Wi-Fi spots using real-time location-based information delivery features. So far, usage statistics for over 2.5 million users have been collected and will be analyzed to drive new citizen initiatives by municipalities in the years to come. Wi2 plans to expand its networks to 50 more municipalities.

## 12.2 Powering the Shenzhen Talent Institute with Wi-Fi 7

Since the onset of the COVID-19 pandemic, internet use and the proliferation of connected devices have accelerated exponentially. Employees in enterprises using broadband internet now carry between three and five mobile devices at work instead of just one. Moreover, the proportion of high-capacity devices—such as virtual reality (VR) and 4K televisions for teleconferencing—is also increasing, requiring higher bandwidth and lower latency.

The Shenzhen Talent Institute offers various education services, including studies on national human talent, innovation, healthcare management, academic exchanges, entrepreneurship, and policy research. The institute is affiliated to the Organization Department of Shenzhen Municipal Committee, China. It is located in the core area of the Xili Lake International Science and Education City, adjacent to the University Town of Shenzhen, covering an area of over 850,000 m<sup>2</sup>.

While the institute's current Wi-Fi 6 network provides sufficient capacity and coverage in regular classrooms, it does not meet the increased bandwidth requirements in the conference rooms, where the WLAN network is under tremendous strain from increased high-definition video meetings. It also struggles to meet the bandwidth needs in the reception centers where students aggregate and create a high concentration of connected devices.

As a result, access points need to deliver more bandwidth to more connected devices and need more scheduling mechanisms to prioritize traffic between different applications or result in unpredictable experiences. Access points (APs) must deliver over 50 Mbps to more than 60 users each to guarantee quality of experience to these users. Another challenge is that enterprise IoT networks deployed in the facilities are deployed and managed separately, which adds cost and complexity to the enterprise network.

To address these challenges, Huawei deployed its latest access point, Wi-Fi 7 AP AirEngine 8771-X1T. The AP actual throughput to a single client device can reach 4.3 Gbps, five times more than the industry average.

Wi-Fi 7 brings various innovations. On the MAC layer (media access control), Multilink Operation (MLO) and Multilink Device (MLD) increase the potential throughput by aggregating spectrum usage from multiple bands simultaneously. In parallel, the transmit opportunity mechanism (TXOP) sharing between coordinated access points (APs) alleviates inter-AP contention, increasing network throughput.

Improvements on the PHY layer include 320MHz channels, 4096 QAM modulation scheme, 16 spatial streams, and Multi Resource Unit (RU) puncturing to protect incumbents.

Huawei's APs have built-in dynamic-zoom smart antennas that will turn omnidirectional or directional dynamically according to user density, resulting in much higher transmission rates and smoother handovers without signal overflows.

The 6 GHz radio frequency can be switched automatically to 5 GHz if clients do not support 6 GHz, or the band is not allowed for Wi-Fi in a given country.

"Facility IoT" refers to the connected devices that improve the overall business efficiency of the building's systems. Facility IoT requires a robust and secure connectivity layer throughout the property. Facility IoT enables the automation of repetitive tasks and a more granular control of the building environment. Further, real-time monitoring of assets is another tremendous benefit of facility IoT. This enables management to address issues immediately since they are instantly notified when problems occur.

Following are other use cases of facility IoT:

- Monitor building access (security cameras, smart locks, key card readers, elevators, etc.)
- Automate functions to optimize energy consumption and reduce energy and maintenance bills
- Detect and stop water leaks

- Reduce and manage the temperature of unoccupied offices
- Monitor moisture sensors, smoke detectors, and light or motion sensors
- Improve staff productivity (package alerts, mail, orders, interaction with residents, etc.)
- Reduce utility bills
- Use analytics for future business decisions (staffing, maintenance, etc.)
- Reduce overall carbon footprint

The Huawei platform supports important IoT protocols and technologies, such as NearLink, offering connection technologies with lower latency, lower power consumption, wider coverage, and more security. More low-power wide area network (LPWAN) protocols will be added.

Last but not least, Huawei exclusive hybrid cables with 300 meters power over ethernet (PoE)+ power supply combine the benefits of optical and copper cables into one and allow to expand coverage beyond the historical 100-meter.

Runlin Chen, Senior Director of Information Technology at Shenzhen Talent Institute, said, "Our IT-based construction is entering a new era of intelligence. To provide a larger bandwidth for a better wireless access experience for experts, leaders, teachers, and students, we initiated an upgrade program with Huawei Wi-Fi 7, which doubled the bandwidth and the number of concurrent terminals for our customers. We are honored to work with Huawei for joint innovation, take the lead in deploying Wi-Fi 7 networks, and actively pilot emerging teaching modes." Indeed, the deployment of WiFi7 access points increased the number of concurrent users from 30 users (20 Mbit/s per user) to 60 users (50 Mbit/s per user).

Tolly, an independent testing lab, completed a performance evaluation and feature validation of Huawei AirEngine Series Wi-Fi 6/7 Access Points. The following are some of the key results:

- The 6GHz radio of each Huawei Wi-Fi 7 AP (AirEngine 8771-X1T) can provide up to 4.33Gbps throughput for a single Wi-Fi 7 endpoint, the best single-user performance that Tolly has tested so far.
- Each Huawei Wi-Fi 7 AP (AirEngine 8771-X1T) provides up to 13.25Gbps wireless network throughput, the highest AP throughput tested by Tolly.
- The 5GHz radio of Wi-Fi 6 APs can respectively provide 1571Mbps, 765Mbps, and 762Mbps for each user at a distance of 20 meters.
- Ultra-low latency: Huawei Wi-Fi 7's latency is as low as 2 ms.

In addition, intelligent multimedia scheduling enables video conferences to run more smoothly, resulting in a 30 % reduction in user complaints.

New models of WiFi 7 access points will be expected to be released, supporting new use cases such as high-density convention centers, stadiums, and industrial Wi-Fi.

## Special thanks to all companies that supported the production of this year's Industry Report:

AT&T	Adentro	Altai Technologies Ltd
American Bandwidth	American Tower	Boingo Wireless
Boldyn Networks	CDOT	CIGTEL
Charter	Cisco	Cityroam
Comcast Business	Dell'Oro Group	Deutsche Telekom
ER Telecom	Enea	Ethiotelecom
Extreme Networks	Guglielmo	Hechtman Venture Development
Heights Telecom Switzerland SA	Hotwire Communications	Huawei Technology
Indio Networks	Inmarsat	Intel
Korea Telecom	Lifemote	Meta
Minime Labs	Monsoon Networks	NetExperience
Panasonic	Polytechnic Institute of Viseu	Rakuten
Rural Broadband Partners	Samsung	Shenzhen Talent Institute
Single Digits	Spot On Networks	TecExpert Brasil
Tokyo Metropolitan Government	Universal Creative	Wire and Wirelss Co. Ltd.