

M162K

16" Champion

2,170 CFM

Motor: 12V LL 225W
Direction: Reversible
Blade: S-Blade
Depth: 3.37"
Amps: 18.0



24V Option Also Available.

(800) 403-7953 • www.MaradyneHP.com

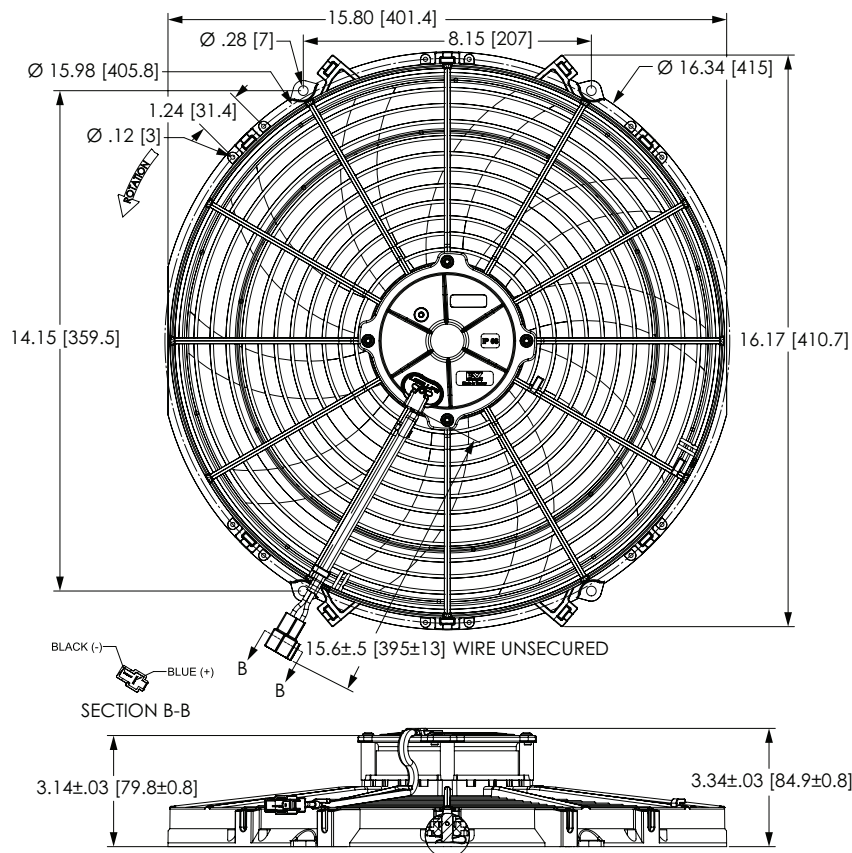

LOW PROFILE FANS

Lowest Profile **High Performance** on the Market

QUIET S-BLADE DESIGN

Works as a Pusher or a Puller as Needed in Application

INDUSTRY LEADING PERFORMANCE

Dynamically Balanced to Provide Smooth Performance & Low Noise

LONG LIFE MOTOR

Waterproof & Dustproof (IP68) for Extreme Environments

SUPERIOR QUALITY

3 Year Warranty

INCLUDES

Locking Mating Pigtail Connector

TYPICAL PERFORMANCE DATA

M162K 16" LP REVERSIBLE CHAMPION LL 12V 225W

STATIC IN H ₂ O	TOTAL FLOW CFM	AMPS
0	2170	18.0
0.1	2034	18.2
0.2	1984	18.8
0.3	1716	19.0
0.4	1462	19.0
0.5	1208	18.8
0.6	890	17.9
0.7	540	17.3
0.8	222	17.3

