

Electric Airless Sprayers

3A4168B

EN

For professional use only.
Not approved for use in European explosive atmosphere locations.
For portable spray application of architectural paints and coatings.
3300 psi (22.7 MPa, 227 bar) Maximum Working Pressure



Important Safety Instructions

Read all warnings and instructions in this manual and in related manuals.
Be familiar with the controls and the proper usage of the equipment.
Save these instructions.

Related Manuals:	Paint	Texture
Gun	3A4133 / 312363	3A0413 / 309495
Pump	333028	333028

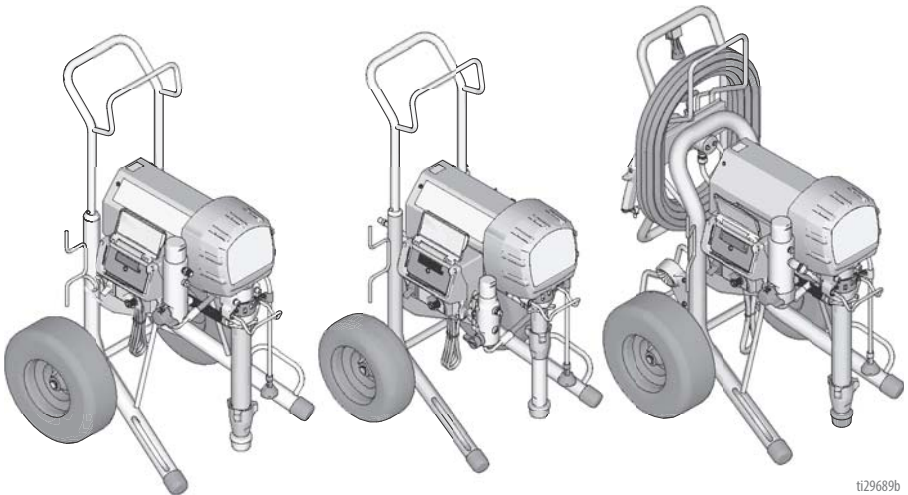

tiz9689b



Models

Model Use	Part Number	Voltage
Paint	17M222	110V
	17M212	
Texture	17M223	
	17M213	
Paint	17M202	240V
	17M217	
Texture	17M203	
	17M204	
	17M218	
	17M234	

Table of Contents

Warnings	4
Component Identification	9
Paint and Texture Models	9
Component Identification	10
Hose Reel	10
Grounding	11
Pressure Relief Procedure	13
Setup	14
Startup	16
Switch Tip Installation	18
Spray	18
Clearing Tip Clogs	18
Hose Reel	19
Digital Tracking System	20
Cleanup	22
Troubleshooting	24
Electrical	27
Sprayer Will Not Run	37
Paint	39
Texture	41
Texture Hose Reel	43
Filter Paint	45
Control Box	46
Texture Filter	48
Texture Hose Reel	49
Wiring Diagram	50
110V	50
240V	51
Technical Data	52
Paint Sprayers	52
Texture Sprayers	53

Warnings

The following warnings are for the setup, use, grounding, maintenance, and repair of this equipment. The exclamation point symbol alerts you to a general warning and the hazard symbols refer to procedure-specific risks. When these symbols appear in the body of this manual or on warning labels, refer back to these Warnings. Product-specific hazard symbols and warnings not covered in this section may appear throughout the body of this manual where applicable.

WARNING



GROUNDING

This product must be grounded. In the event of an electrical short circuit, grounding reduces the risk of electric shock by providing an escape wire for the electric current. This product is equipped with a cord having a grounding wire with an appropriate grounding plug. The plug must be plugged into an outlet that is properly installed and grounded in accordance with all local codes and ordinances.

- Improper installation of the grounding plug is able to result in a risk of electric shock.
- When repair or replacement of the cord or plug is required, do not connect the grounding wire to either flat blade terminal.
- The wire with insulation having an outer surface that is green with or without yellow stripes is the grounding wire.
- Check with a qualified electrician or serviceman when the grounding instructions are not completely understood, or when in doubt as to whether the product is properly grounded.
- Do not modify the plug provided; if it does not fit the outlet, have the proper outlet installed by a qualified electrician.
- This product is for use on a nominal 110V or 230V circuit and has a grounding plug similar to the plugs illustrated in the figure below.

110V UK



230V

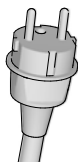

- Only connect the product to an outlet having the same configuration as the plug.
- Do not use an adapter with this product.

Extension Cords:

- Use only a 3-wire extension cord that has a grounding plug and a grounding receptacle that accepts the plug on the product.
- Make sure your extension cord is not damaged. If an extension cord is necessary, use 12 AWG (2.5 mm²) minimum to carry the current that the product draws.
- An undersized cord results in a drop in line voltage and loss of power and overheating.

WARNING
**SKIN INJECTION HAZARD**

High-pressure spray is able to inject toxins into the body and cause serious bodily injury. In the event that injection occurs, **get immediate surgical treatment**.

- Do not aim the gun at, or spray any person or animal.
- Keep hands and other body parts away from the discharge. For example, do not try to stop leaks with any part of the body.
- Always use the nozzle tip guard. Do not spray without nozzle tip guard in place.
- Use Graco nozzle tips.
- Use caution when cleaning and changing nozzle tips. In the case where the nozzle tip clogs while spraying, follow the **Pressure Relief Procedure** for turning off the unit and relieving the pressure before removing the nozzle tip to clean.
- Equipment maintains pressure after power is shut off. Do not leave the equipment energized or under pressure while unattended. Follow the **Pressure Relief Procedure** when the equipment is unattended or not in use, and before servicing, cleaning, or removing parts.
- Check hoses and parts for signs of damage. Replace any damaged hoses or parts.
- This system is capable of producing 3300 psi. Use Graco replacement parts or accessories that are rated a minimum of 3300 psi.
- Always engage the trigger lock when not spraying. Verify the trigger lock is functioning properly.
- Verify that all connections are secure before operating the unit.
- Know how to stop the unit and bleed pressure quickly. Be thoroughly familiar with the controls.

WARNING



FIRE AND EXPLOSION HAZARD

Flammable fumes, such as solvent and paint fumes, in **work area** can ignite or explode. Paint or solvent flowing through the equipment can cause static sparking. To help prevent fire and explosion:



- Do not spray flammable or combustible materials near an open flame or sources of ignition such as cigarettes, motors, and electrical equipment.
- Paint or solvent flowing through the equipment is able to result in static electricity. Static electricity creates a risk of fire or explosion in the presence of paint or solvent fumes. All parts of the spray system, including pump, hose assembly, spray gun, and objects in and around the spray area shall be properly grounded to protect against static discharge and sparks. Use Graco conductive or grounded high-pressure airless paint sprayer hoses.
- Verify that all container and collection systems are grounded to prevent static discharge. Do not use pail liners unless they are anti-static or conductive.
- Connect to a grounded outlet and use grounded extension cords. Do not use a 3-to-2 adapter.
- Do not use a paint or a solvent containing halogenated hydrocarbons.
- Do not spray flammable or combustible liquids in a confined area.
- Keep spray area well-ventilated. Keep a good supply of fresh air moving through the area.
- Sprayer generates sparks. Keep pump assembly in a well ventilated area at least 20 feet (6 m) from the spray area when spraying, flushing, cleaning, or servicing. Do not spray pump assembly.
- Do not smoke in the spray area or spray where sparks or flame is present.
- Do not operate light switches, engines, or similar spark producing products in the spray area.
- Keep area clean and free of paint and solvents being sprayed. Read all Safety Data Sheets (SDSs) and container labels provided with the paints and solvents manufacturer's safety instructions.
- Fire extinguisher equipment shall be present and working.

WARNING



EQUIPMENT MISUSE HAZARD

Misuse can cause death or serious injury.



- Always wear appropriate gloves, eye protection, and a respirator or mask when painting.
- Do not operate or spray near children. Keep children away from equipment at all times.
- Do not overreach or stand on an unstable support. Keep effective footing and balance at all times.
- Stay alert and watch what you are doing.
- Do not operate the unit when fatigued or under the influence of drugs or alcohol.
- Do not kink or over-bend the hose.
- Do not expose the hose to temperatures or to pressures in excess of those specified by Graco.
- Do not use the hose as a strength member to pull or lift the equipment.
- Do not spray with a hose shorter than 25 feet.
- Do not alter or modify equipment. Alterations or modifications may void agency approvals and create safety hazards.
- Make sure all equipment is rated and approved for the environment in which you are using it.



ELECTRIC SHOCK HAZARD

This equipment must be grounded. Improper grounding, setup, or usage or the system can cause electric shock.



- Turn off and disconnect power cord before servicing equipment.
- Connect only to grounded electrical outlets.
- Use only 3-wire extension cords.
- Ensure ground prongs are intact on power and extension cords.
- Do not expose to rain. Store indoors.
- Wait five minutes after disconnecting power cord before servicing large capacitor units.



PRESSURIZED ALUMINUM PARTS HAZARD

Use of fluids that are incompatible with aluminum in pressurized equipment can cause serious chemical reaction and equipment rupture. Failure to follow this warning can result in death, serious injury, or property damage.

- Do not use 1,1,1-trichloroethane, methylene chloride, other halogenated hydrocarbon solvents or fluids containing such solvents.
- Do not use chlorine bleach.
- Many other fluids may contain chemicals that can react with aluminum. Contact your material supplier for compatibility.

Warnings

WARNING



MOVING PARTS HAZARD

Moving parts can pinch, cut or amputate fingers and other body parts.

- Keep clear of moving parts.
- Do not operate equipment with protective guards or covers removed.
- Pressurized equipment can start without warning. Before checking, moving, or servicing equipment, follow the **Pressure Relief Procedure** and disconnect all power sources.



PERSONAL PROTECTIVE EQUIPMENT

Wear appropriate protective equipment when in the work area to help prevent serious injury, including eye injury, hearing loss, inhalation of toxic fumes, and burns. Protective equipment includes but is not limited to:

- Protective eyewear, and hearing protection.
- Respirators, protective clothing, and gloves as recommended by the fluid and solvent manufacturer.

CALIFORNIA PROPOSITION 65

The engine exhaust from this product contains a chemical known to the State of California to cause cancer, birth defects or other reproductive harm.

This product contains a chemical known to the State of California to cause cancer, birth defects or other reproductive harm. Wash hands after handling.

Component Identification

Paint and Texture Models

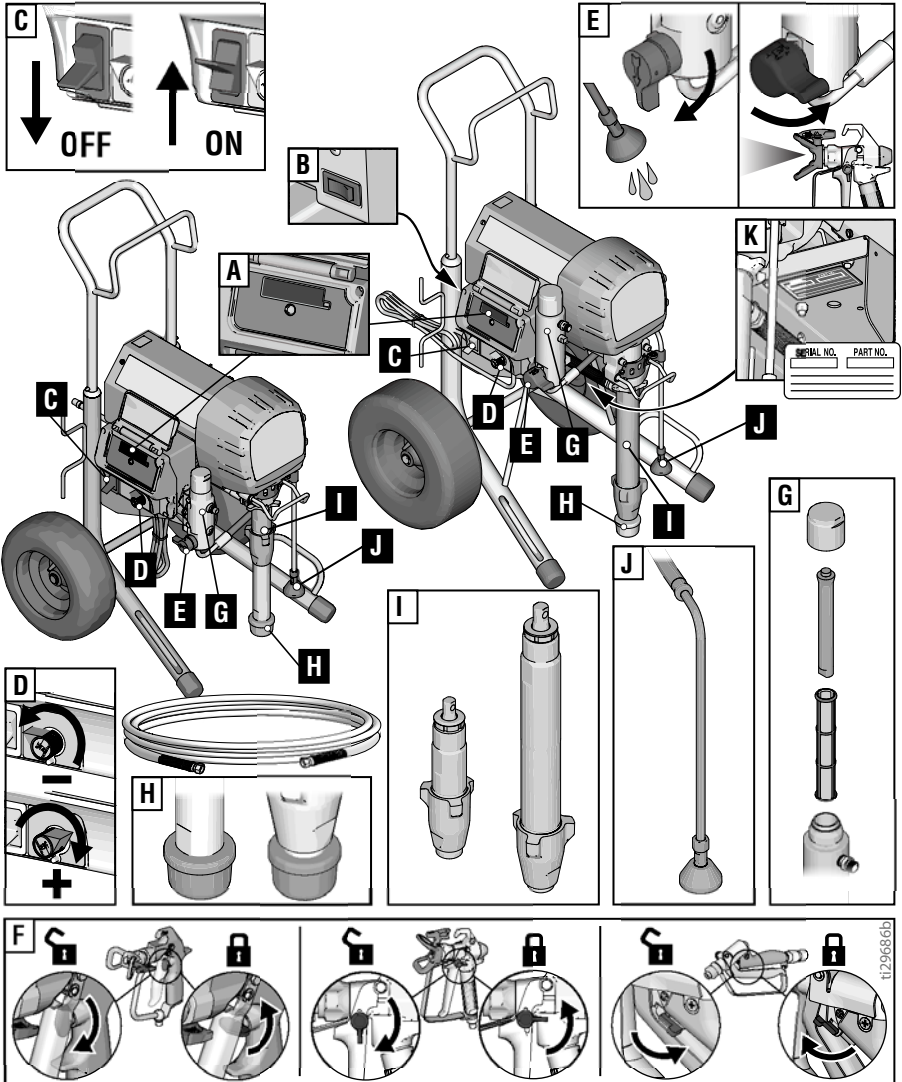

A	Display
B	AMP Switch (not available on all units)
C	ON/OFF Switch
D	Pressure Control
E	Prime / Spray Valve
F	Trigger Lock

G	Filter
H	Strainer
I	Pump
J	Drain Tube
K	Model/Serial Tag

Component Identification

Component Identification

Hose Reel

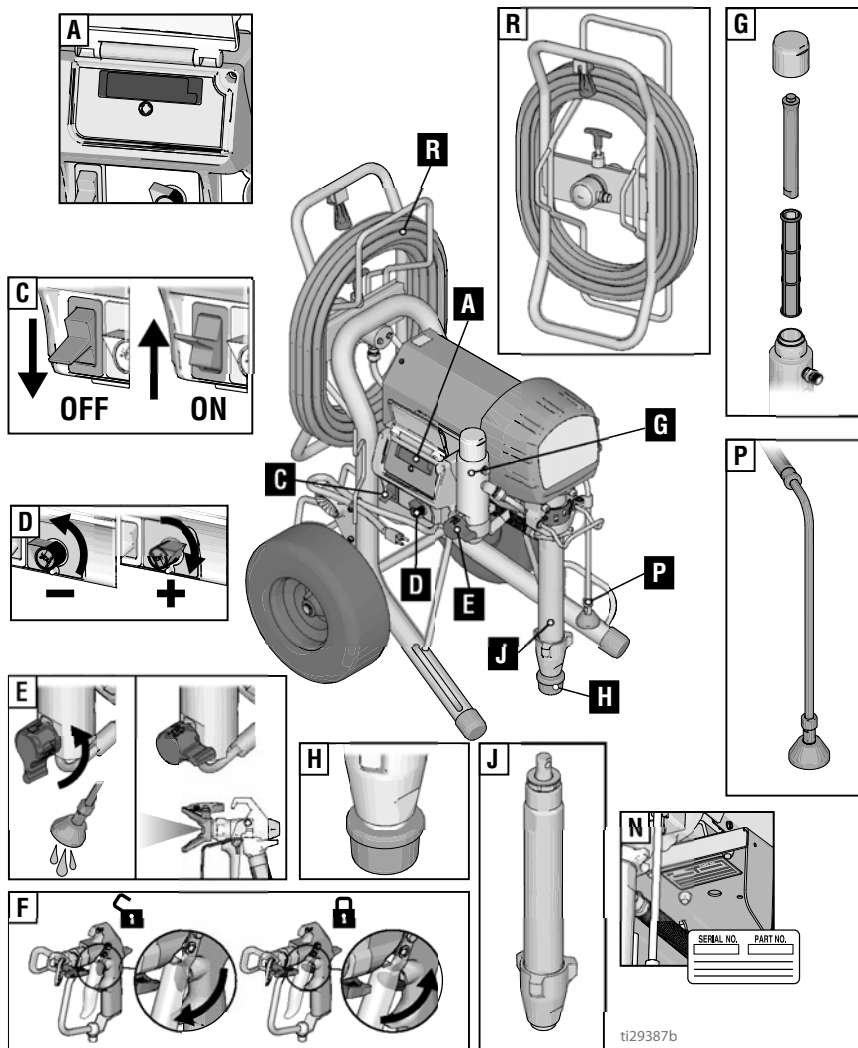

ti29387b

A	Display
C	ON/OFF Switch
D	Pressure Control
E	Spray / Prime
F	Trigger Lock
G	Filter

H	Strainer
J	Pump
N	Unit / Serial Tag
P	Drain Tube
R	Hose Reel

Grounding



This equipment must be grounded to reduce the risk of static sparking and electric shock. Electric or static sparking can cause fumes to ignite or explode. Improper grounding can cause electric shock. Grounding provides an escape wire for the electric current.

The sprayer cord includes a grounding wire with an appropriate grounding contact. Do not use the sprayer if the electrical cord has a damaged ground contact.

The plug must be plugged into an outlet that is properly installed and grounded in accordance with all local codes and ordinances.

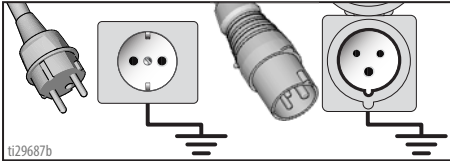

Do not modify plug! If it will not fit in outlet, have grounded outlet installed by a qualified electrician. Do not use an adapter.

Power Requirements

- 100-120V units require 100-120 VAC, 50/60 Hz, 15A, 1 phase
- 230V units require 220-240 VAC, 50/60 Hz, 10A

Extension Cords

Use an extension cord with an undamaged ground contact.

If an extension cord is necessary, use a 3-wire, 12 AWG (2.5 mm²) minimum. Longer cords and higher gauge cords reduce sprayer performance.

Grounding

Pails



Solvent and oil-based fluids: follow local code. Use only conductive metal pails, placed on a grounded surface such as concrete.

Do not place pail on a nonconductive surface such as paper or cardboard which interrupts grounding continuity.



ti5850b

Grounding a metal pail: connect a ground wire to the pail by clamping one end to pail and other end to a true earth ground.

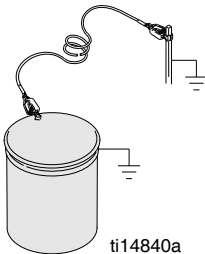

ti14840a

To maintain grounding continuity when flushing or relieving pressure: hold metal part of spray gun firmly to side of a grounded metal pail. Then trigger gun.

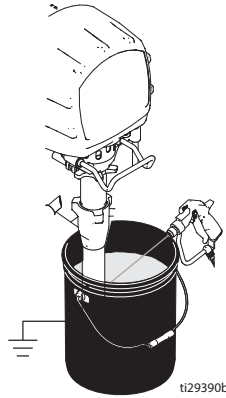

ti29390b

15/20 Amp Switch

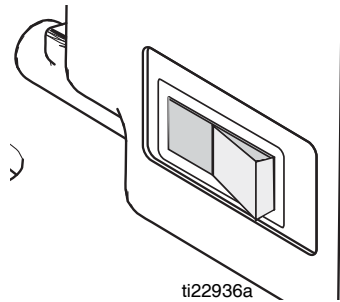

ti22936a

Select 15A or 20A setting based on your circuit rating.

Pressure Relief Procedure

Pressure Relief Procedure



Follow the **Pressure Relief Procedure** whenever you see this symbol.

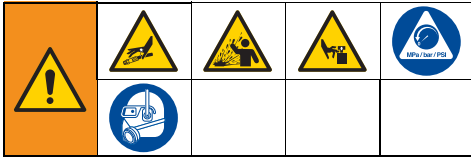

This equipment stays pressurized until pressure is manually relieved. To help prevent serious injury from pressurized fluid, such as skin injection, splashing fluid and moving parts, follow the **Pressure Relief Procedure** when you stop spraying and before cleaning, checking, or servicing the equipment.

1. Turn power OFF. Wait 7 seconds for power to dissipate.

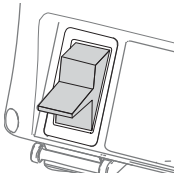

2. Engage trigger lock.

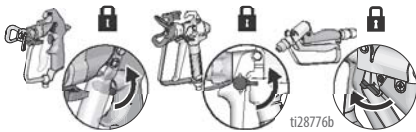

3. Remove guard and SwitchTip.

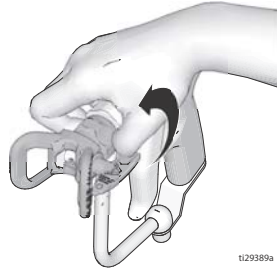

4. Turn pressure to lowest setting. Trigger gun to relieve pressure.

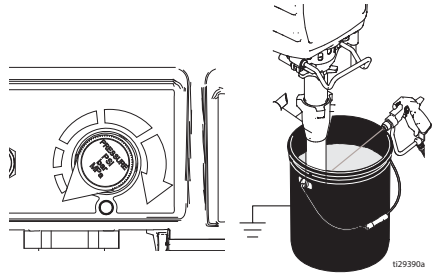

5. Put drain tube in pail. Turn prime valve down to DRAIN position. Leave prime valve in DRAIN position until you are ready to spray again.

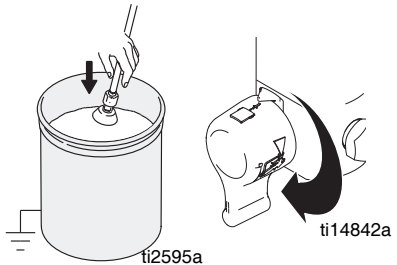

6. If you suspect the spray tip or hose is clogged or that pressure has not been fully relieved:
 - a. **VERY SLOWLY** loosen the tip guard retaining nut or the hose end coupling to relieve pressure gradually.
 - b. Loosen the nut or coupling completely.
 - c. Clear the obstruction in the hose or tip.

Setup

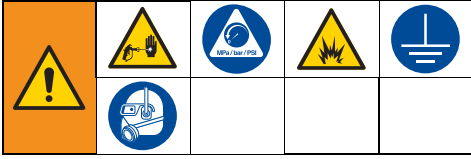

1. **All sprayers except hose reel:** Connect airless hose to sprayer. Tighten securely.

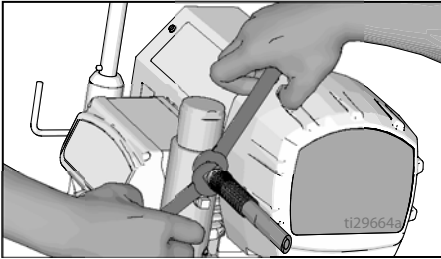

If using the optional hopper, remove the nipple fitting from the filter. Install 45° elbow (included with hopper accessory kit) into filter and install nipple fitting into elbow. Then connect the hose to the nipple.

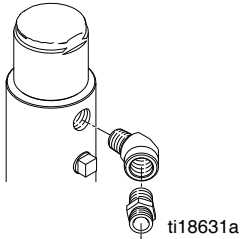

NOTE: Make sure nipple fitting is angled away from hopper so the hose can be easily installed.

2. Connect swivel and gun to other end of hose. Tighten securely.

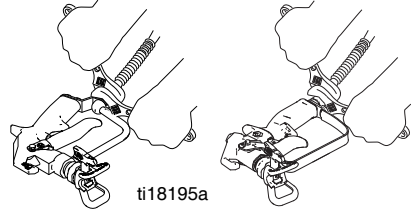

3. Engage trigger lock.



4. Remove tip guard.

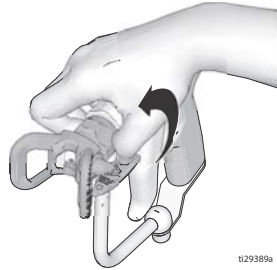

5. Check inlet strainer for clogs and debris,



6. Fill throat packing nut with Throat Fluid to prevent premature packing wear. Do this each time you spray.

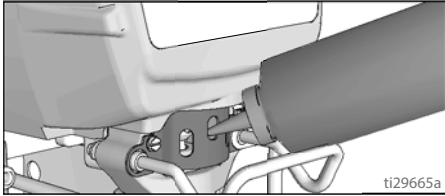

7. Turn power OFF.

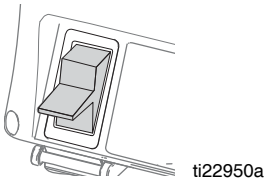

8. Plug power supply cord into a properly grounded electrical outlet.

9. Turn prime valve down to DRAIN position.

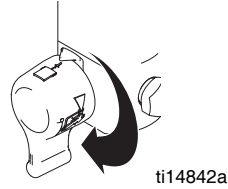

10. Place pump in grounded metal pail partially filled with flushing fluid. Attach ground wire to pail and to true earth ground. Perform steps 1 - 5 of **Startup** to flush out storage oil shipped in sprayer. Use water to flush water-base paint and mineral spirits to flush oil-base paint and storage oil.

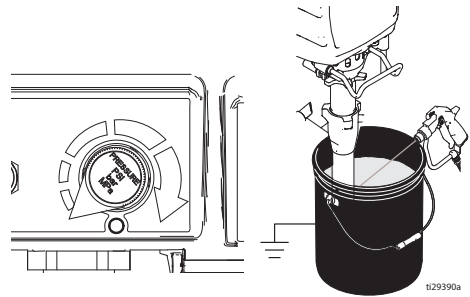

Startup

Startup

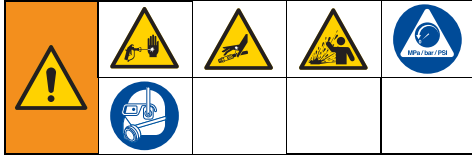

1. Perform **Pressure Relief Procedure**, page 13.
2. Turn pressure control to lowest pressure.

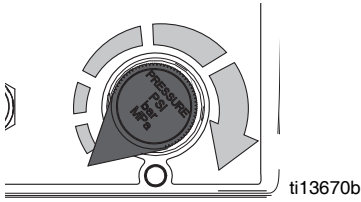

3. Turn power **ON**.

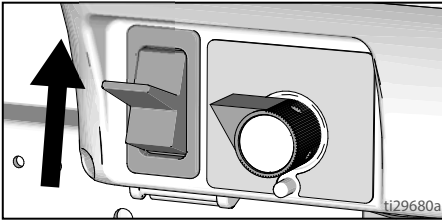

4. Increase pressure 1/2 turn to start motor and allow fluid to circulate through drain tube for 15 seconds; turn pressure down.



15sec.

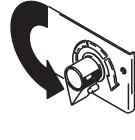

5. Turn prime valve forward to **SPRAY** position. Disengage trigger lock.

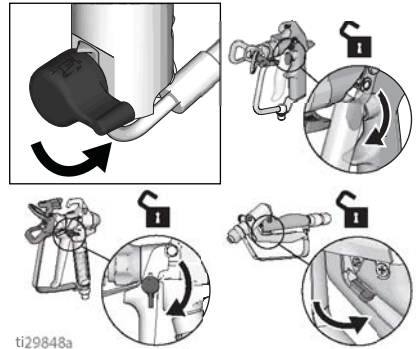

6. Hold gun against grounded metal flushing pail. Trigger gun and increase fluid pressure 1/2 turn. Flush 1 minute.

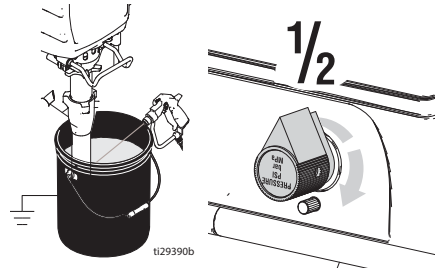



High-pressure spray is able to inject toxins into the body and cause serious bodily injury. Do not stop leaks with hand or rag.

7. Inspect for leaks. If leaks occur, perform **Pressure Relief Procedure**, page 13. Tighten fittings. Performs **Startup**, steps 1-5. If no leaks, proceed to step 8.
8. Place pump in paint pail.

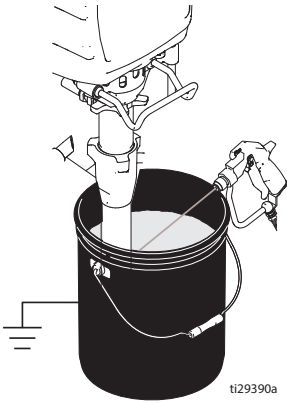

9. Trigger gun again into flushing pail until paint appears. Move gun to paint pail and trigger for 20 seconds.

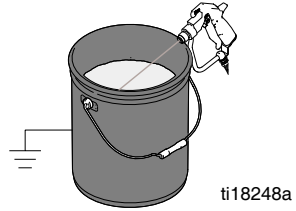

10. Engage trigger lock. Assemble tip and guard, see instructions on next page.

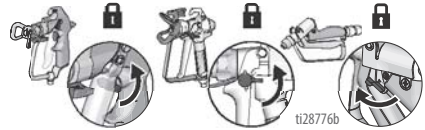

Switch Tip Installation

Switch Tip Installation



1. Perform **Pressure Relief Procedure**, page 13.
2. Use spray tip (A) to insert seal (B) into guard (C).

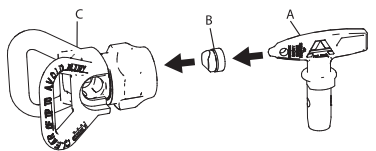

ti29398a

3. Insert Switch Tip.

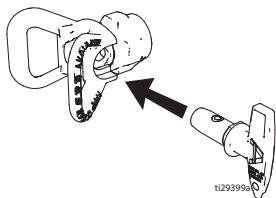

ti29399a

4. Screw assembly onto gun. Tighten.

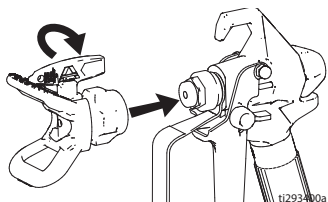

ti293400a

Spray

1. Spray test pattern. Increase pressure to eliminate heavy edges. Use smaller tip size if pressure adjustment can not eliminate heavy edges.

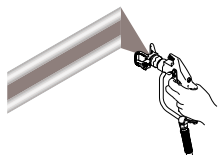

ti18243a

2. Hold gun perpendicular, 10-12 in. (25-30 cm) from surface. Spray back and forth. Overlap by 50%. Trigger gun after moving and release before stopping.

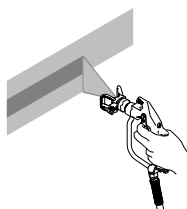

ti18242a

Clearing Tip Clogs



To avoid serious injury, never point gun at your hand or into a rag.

1. Release trigger, engage trigger lock. Rotate Switch Tip. Disengage trigger lock. Trigger gun to clear clog.

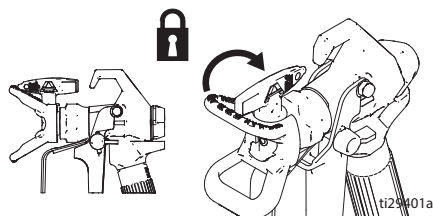

ti29401a

2. Engage trigger lock. Return Switch Tip to original position. Disengage trigger lock and continue spraying.

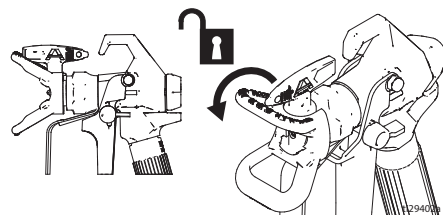

ti29402a

Hose Reel



Moving parts can pinch, cut or amputate fingers and other body parts. To avoid injury from moving parts, be sure to keep your head clear of hose reel while winding up hose.

1. Make sure hose is routed through hose guide.

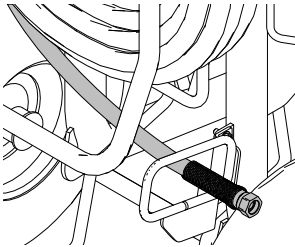

ti18241a

2. Lift and turn pivot lock 90° to unlock hose reel. Pull on hose to remove it from hose reel.

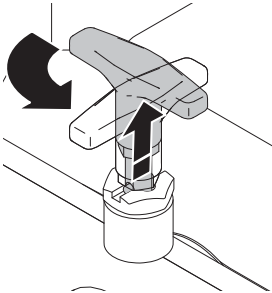

ti13501c

3. Pull reel handle up and turn clockwise to reel in hose.

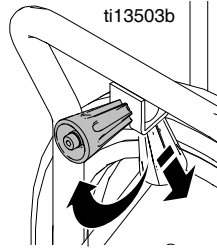

ti13503b

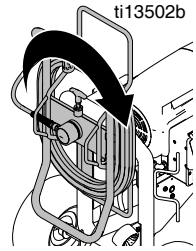

ti13502b

NOTE: The hose reel can be locked into two positions: Usage (A) and Storage (B).

(A)

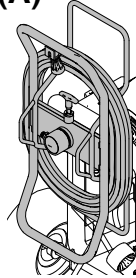

(B)

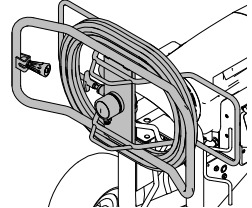

ti13563b

Digital Tracking System

Digital Tracking System

Operation Main Menu

Short press to move to next display. Press and hold (5 seconds) to change units or reset data.

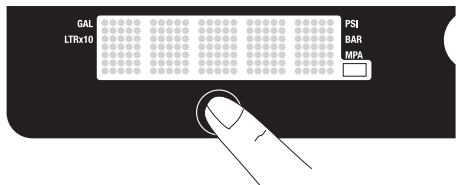

1. Turn pressure to lowest setting. Trigger gun to relieve pressure. Turn prime valve down to DRAIN position.

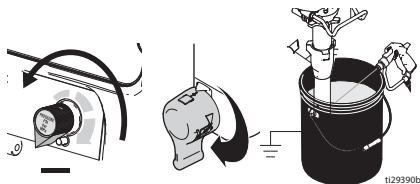

2. Turn power ON. Pressure display appears. Dashes will not appear unless pressure is less than 200 psi (14 bar, 1,4 MPa).

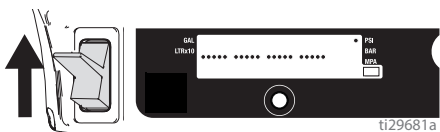

Change Display Units

Press and hold button for 5 seconds to change pressure units (**psi, bar, MPa**) to desired units. Selection of bar or MPa changes **gallons to liters x 10**. To change display units must be in pressure display mode and pressure must be at zero.

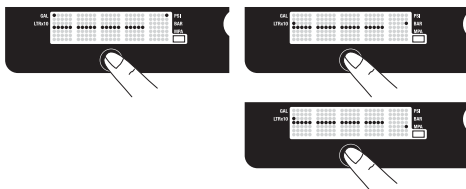

Job Gallons

1. Short press button to move to Job Gallons (or liters x 10).

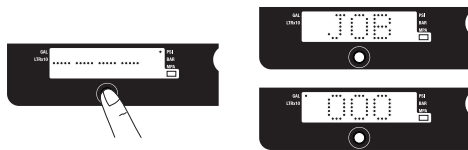

NOTE: **JOB** scrolls past, then the number of gallons sprayed above 1000 psi (70 bar, 7 MPa) displays.

2. Press and hold to reset to zero.

Lifetime Gallons

1. Short press button to move to Lifetime Gallons (or liters x 0).

NOTE: **LIFE** scrolls briefly, then the number of gallons sprayed above 1000 psi (70 bar, 7 MPa) displays.

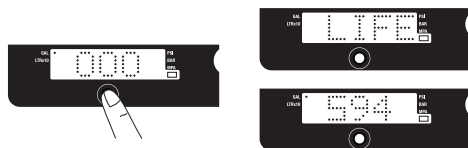

Secondary Menu - Stored Data

1. Perform **Pressure Relief**, steps 1 - 4 if they have not already been done.
2. Turn power switch on while holding button down.

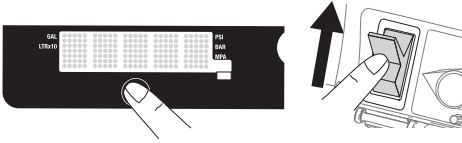

3. **SERIAL NUMBER** scrolls past and then serial number (e.g. 00001) displays.



4. Short press button and **MOTOR HOURS** scrolls past and then total motor run hours are displayed.



5. Short press button. **LAST CODE** scrolls by and last code is displayed; e.g. **E=07** (see troubleshooting).

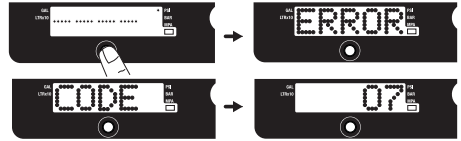

6. Press and hold button to clear code to zero.



7. Short press to move to **SOFTWARE REV.**
8. Short press button. **MOTOR ID RESISTOR** scrolls by and model code number (see below).

Motor ID Number	Models
0	Paint
4	Texture (230 V)
6	Texture (110 V)

Cleanup



1. Perform **Pressure Relief Procedure**, page 13, steps 1 - 4. Remove tip guard from gun.

NOTE: Use water for water-base material, mineral spirits for oil-base material, or other solvents recommended by manufacturer.

2. Turn power **ON**. Turn prime valve forward to **SPRAY** position.

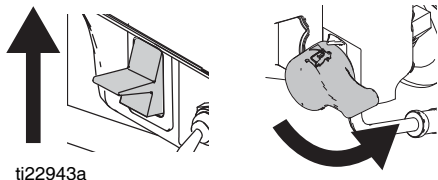

3. Increase pressure to 1/2. Hold gun against pail. Disengage trigger lock. Trigger gun until flushing fluid appears.

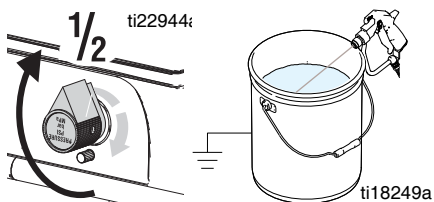

4. Move gun to waste pail, hold gun against pail, trigger gun to thoroughly flush system. Release trigger and engage trigger lock.

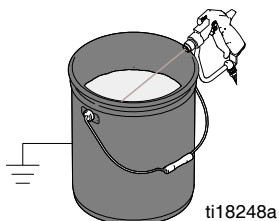

5. Turn prime valve down to **DRAIN** position and allow flushing fluid to circulate until flushing fluid appears clear.

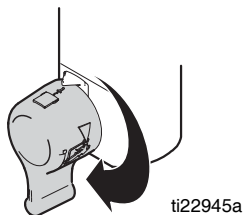

6. Turn prime valve forward to **SPRAY** position. Trigger gun into flushing pail to purge fluid from hose.

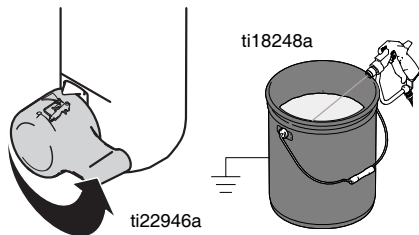

7. Raise pump above flushing fluid and run sprayer for 15 to 30 seconds to drain fluid. Turn power **OFF**.

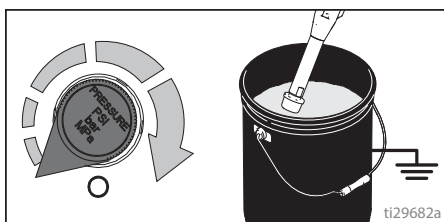

8. Turn prime valve down **DRAIN** position. Unplug sprayer.

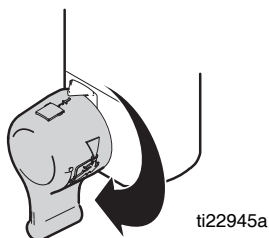

9. Remove filters from gun and sprayer, if installed. Clean and inspect. Install filters.

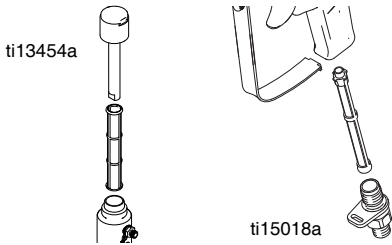

11. Wipe sprayer, hose and gun with a rag soaked in water or mineral spirits.

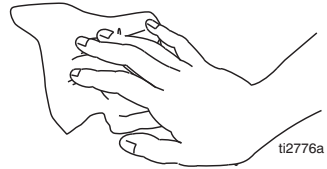

10. If flushing with water, flush again with mineral spirits, or Pump Life, to leave a protective coating to prevent freezing or corrosion.

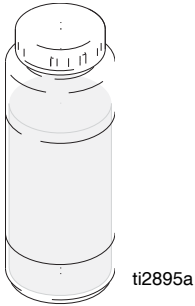

Troubleshooting

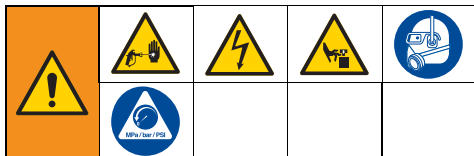

Perform **Pressure Relief Procedure**, page 13.

PROBLEM	CAUSE	SOLUTION
For units with display: CODE XX is displayed.	Fault condition exists	Determine fault correction from table, page 27.
Pump output is low	Spray tip worn	Follow Pressure Relief Procedure on page 13, then replace tip. See your separate gun or tip manual.
	Spray tip clogged	Relieve pressure. Check and clean spray tip.
	Paint supply	Refill and reprime pump.
	Intake strainer clogged	Remove and clean, then reinstall
	Intake valve ball and piston ball are not seating properly	Remove intake valve and clean. Check balls and seats for nicks; replace if necessary; see pump manual. Strain paint before using to remove particles that could clog pump.
	Fluid filter, tip filter, or tip is clogged or dirty.	Clean filter.
	Prime valve leaking	Relieve pressure. Repair prime valve.
	Verify pump does not continue to stroke when gun trigger is released. (Prime valve not leaking.)	Service pump; see pump manual.
Leaking around throat packing nut which may indicate worn or damaged packings.	Replace packings; see pump manual. Also check piston valve seat for hardened paint or nicks and replace if necessary. Tighten packing nut/wet-cup.	

PROBLEM	CAUSE	SOLUTION
Pump output is low	Pump rod damage	Repair pump. See pump manual.
	Low stall pressure	Turn pressure knob fully clockwise. Make sure pressure control knob is properly installed to allow full clockwise position. If problem persists, replace pressure transducer.
	Piston packings are worn or damaged	Replace packings; see pump manual.
	O-ring in pump is worn or damaged	Replace o-ring; see pump manual.
	Intake valve ball is packed with material	Clean intake valve; see pump manual.
	Pressure setting is too low	Increase pressure.
	Large pressure drop in hose with heavy materials	Use larger diameter hose and/or reduce overall length of hose.
	Check to see if Amp switch (15/20) is on low setting. Make sure circuit is able to provide high setting.	Switch to 20A setting. Change to circuit that provides 20A. Change to less loaded circuit.
Motor runs but pump does not stroke	Displacement pump pin damaged or missing.	Replace pump pin if missing. Be sure retainer spring is fully in groove all around connecting rod.
	Connecting rod assembly damaged.	Replace connecting rod assembly.
	Gears or drive housing damaged.	Inspect drive housing assembly and gears for damage and replace if necessary.
Excessive paint leakage into throat packing nut	Throat packing nut is loose	Remove throat packing nut spacer. Tighten throat packing nut just enough to stop leakage.
	Throat packings are worn or damaged	Replace packings; see pump manual.
	Displacement rod is worn or damaged	Replace rod; see pump manual.
Fluid is spitting from gun	Air in pump or hose	Check and tighten all fluid connections. Cycle pump as slowly as possible during priming.
	Tip is partially clogged	Clear tip.
	Fluid supply is low or empty	Refill fluid supply. Prime pump. Check fluid supply often to prevent running pump dry.

Troubleshooting

PROBLEM	CAUSE	SOLUTION
Pump is difficult to prime	Air in pump or hose	Check and tighten all fluid connections. Cycle pump as slowly as possible during priming.
	Intake valve is leaking	Clean intake valve. Be sure ball seat is not nicked or worn and that ball seats well. Reassemble valve.
	Pump packings are worn	Replace pump packings; see pump manual.
	Paint is too thick	Thin the paint according to supplier recommendations.
No display, sprayer operates	Display is damaged or has bad connection	Check connections. Replace display.

Electrical

Symptom: Sprayer does not run, stops running, or will not shut off.

Perform **Pressure Relief Procedure**; page 13.



1. Plug sprayer into correct voltage, grounded outlet.

2. Set power switch OFF for 30 seconds and then ON again (this ensure sprayer is in normal run mode).
3. Turn pressure control knob clockwise 1/2 turn.
4. View digital display.



Keep clear of electrical and moving parts during troubleshooting procedures. To avoid electrical shock hazards when covers are removed for troubleshooting, wait 5 minutes after unplugging power cord for stored electricity to dissipate.

PROBLEM	CAUSE	SOLUTION
Sprayer does not run at all	See flow chart, page 35.	
Display is blank		

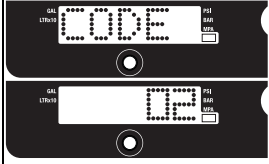

Troubleshooting

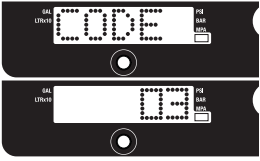
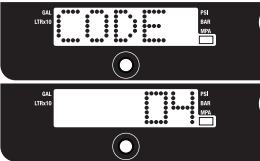
PROBLEM	CAUSE	SOLUTION
<p>Sprayer does not run at all</p> <p>Display shows CODE 02</p>  <p>The first image shows a digital display with 'CODE' in large characters. The second image shows the same display with '02' in large characters. Both images have 'G.L. 1700-11' on the left and 'P11 000 020' on the right.</p>	<p>Check transducer or transducer connections</p>	<ol style="list-style-type: none"> 1. Make sure there is no pressure in the system (see Pressure Relief Procedure, page 13). Check fluid path for clogs, such as clogged filter. 2. Use airless paint spray hose with no metal braid 1/4 in. x 50 ft minimum. Smaller hose or metal braid hose may result in high-pressure spikes. 3. Set sprayer to OFF and disconnect power to sprayer. 4. Check transducer and connections to control board. 5. Disconnect transducer from control board socket. Check that transducer and control board contacts are clean and secure. 6. Reconnect transducer to control board socket. Connect power, set sprayer ON and control knob 1/2 turn clockwise. If sprayer does not run properly, set sprayer to OFF and go to next step. 7. Install new transducer. Connect power, set sprayer ON and control knob 1/2 turn clockwise. Replace control board if sprayer does not run properly.

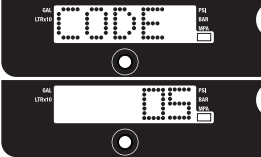
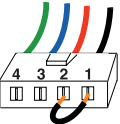
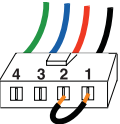
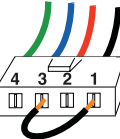
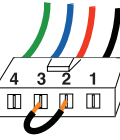

PROBLEM	CAUSE	SOLUTION
<p>Sprayer does not run at all</p> <p>Display shows CODE 03</p> 	<p>Check transducer or transducer connections (control board is not detecting a pressure signal).</p>	<ol style="list-style-type: none"> 1. Set sprayer to OFF and disconnect power to sprayer. 2. Check transducer and connections to control board. 3. Disconnect transducer from control board socket. Check to see if transducer and control board contacts are clean and secure. 4. Reconnect transducer to control board socket. Connect power, set sprayer ON and control knob to 1/2 turn clockwise. If sprayer does not run, set sprayer to OFF and go to next step. 5. Connect a confirmed working transducer to control board socket. 6. Set sprayer ON and control knob to 1/2 turn clockwise. If sprayer runs, install new transducer. Replace control board if sprayer does not run. 7. Check transducer resistance with ohmmeter (less than 9k ohm between red and black wires and 3-6k ohm between green and yellow wires).
<p>Sprayer does not run at all</p> <p>Display shows CODE 04</p> 	<p>Check voltage supply to the sprayer (control board is detecting a multiple voltage surges).</p>	<ol style="list-style-type: none"> 1. Set sprayer to OFF and disconnect power to sprayer. 2. Locate a good voltage supply to prevent damage to electronics.

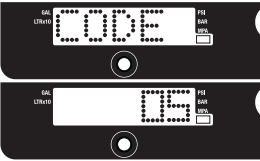
Troubleshooting

PROBLEM	CAUSE	SOLUTION
<p data-bbox="29 191 291 215">Sprayer does not run at all</p> <p data-bbox="29 228 291 253">Display shows CODE 05</p> 	<p data-bbox="306 191 603 402">Control is commanding motor to run but motor shaft does not rotate. Possibly locked rotor condition, an open connection exists between motor and control, there is a problem with motor or control board, or motor amp draw is excessive.</p>	<ol style="list-style-type: none"> <li data-bbox="618 191 1005 297">1. Remove pump and try to run sprayer. If motor runs, check for locked or frozen pump or drive train. If sprayer does not run, continue to step 2. <li data-bbox="618 310 1005 354">2. Set sprayer to OFF and disconnect power to sprayer. <li data-bbox="618 367 1005 516">3. Disconnect motor connector(s) from control board socket(s). Check that motor connector and control board contacts are clean and secure. If contacts are clean and secure, continue to step 4. <li data-bbox="618 529 1005 651">4. Set sprayer to OFF and spin motor fan 1/2 turn. Restart sprayer. If sprayer runs, replace control board. If sprayer does not run, continue to step 5. <li data-bbox="618 664 1005 1003">5. Perform Spin Test: Test at large 4-pin motor field connector. Disconnect fluid pump from sprayer. Test motor by placing a jumper across pins 1 & 2. Rotate motor fan at about 2 revolutions per second. A cogging resistance to motion should be felt at the fan. The motor should be replaced if no resistance is felt. Repeat for pin combinations 1 & 3 and 2 & 3. Pin 4 (the green wire) is not used in this test. If all spin test is positive, continue to step 6. <div style="text-align: center; margin-top: 20px;"> <p data-bbox="742 1036 958 1060">Green Blue Red Black</p>  <p data-bbox="653 1117 756 1141">STEP 1:</p>  <p data-bbox="653 1263 756 1287">STEP 2:</p>  <p data-bbox="653 1425 756 1450">STEP 3:</p>  </div>

PROBLEM	CAUSE	SOLUTION								
<p data-bbox="56 193 309 217">Sprayer does not run at all</p> <p data-bbox="56 228 291 253">Display shows CODE 05</p> 	<p data-bbox="330 193 625 399">Control is commanding motor to run but motor shaft does not rotate. Possibly locked rotor condition, an open connection exists between motor and control, there is a problem with motor or control board, or motor amp draw is excessive.</p>	<p data-bbox="643 193 1029 347">6. Perform Field Short Test: Test at large 4-pin motor field connector. There should not be continuity from pin 4, the ground wire, and any of the remaining 3 pins. If motor field connector tests fail, replace motor.</p> <p data-bbox="643 371 1029 501">7. Check Motor Thermal Switch: Unplug thermal wires. Set meter to ohms. Meter should read the proper resistance for each unit (see table below).</p>  <table border="1" data-bbox="658 833 1019 967"> <thead> <tr> <th colspan="2" data-bbox="661 837 1016 867">Resistance Table:</th> </tr> </thead> <tbody> <tr> <td data-bbox="661 873 862 899">Paint</td> <td data-bbox="862 873 1016 899">0 ohms</td> </tr> <tr> <td data-bbox="661 906 862 932">Texture (240V)</td> <td data-bbox="862 906 1016 932">3.9k ohms</td> </tr> <tr> <td data-bbox="661 938 862 964">Texture (110V)</td> <td data-bbox="862 938 1016 964">6.2k ohms</td> </tr> </tbody> </table>	Resistance Table:		Paint	0 ohms	Texture (240V)	3.9k ohms	Texture (110V)	6.2k ohms
Resistance Table:										
Paint	0 ohms									
Texture (240V)	3.9k ohms									
Texture (110V)	6.2k ohms									

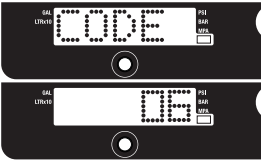
Troubleshooting

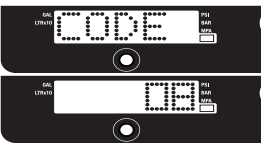
PROBLEM	CAUSE	SOLUTION								
<p data-bbox="29 191 291 215">Sprayer does not run at all</p> <p data-bbox="29 228 291 253">Display shows CODE 06</p> 	<p data-bbox="306 191 603 399">Allow sprayer to cool. If sprayer runs when cool, correct cause of overheating. Keep sprayer in cooler location with good ventilation. Make sure motor air intake is not blocked. If sprayer still does not run, follow Step 1.</p>	<p data-bbox="618 191 990 240">NOTE: Motor must be cooled down for the test.</p> <ol data-bbox="618 253 1001 496" style="list-style-type: none"> 1. Check thermal device connector (yellow wires) at control board. 2. Disconnect thermal device connector from control board socket. Make sure contacts are clean and secure. Measure resistance of the thermal device. If reading is not correct, replace motor. <p data-bbox="666 505 1006 634">Check Motor Thermal Switch: Unplug thermal wires. Set meter to ohms. Meter should read the proper resistance for each unit (see table below).</p>  <table border="1" data-bbox="634 954 993 1089"> <thead> <tr> <th colspan="2" data-bbox="639 959 988 987">Resistance Table:</th> </tr> </thead> <tbody> <tr> <td data-bbox="639 992 839 1019">Paint</td> <td data-bbox="839 992 988 1019">0 ohms</td> </tr> <tr> <td data-bbox="639 1024 839 1052">Texture (240V)</td> <td data-bbox="839 1024 988 1052">3.9k ohms</td> </tr> <tr> <td data-bbox="639 1057 839 1084">Texture (110V)</td> <td data-bbox="839 1057 988 1084">6.2k ohms</td> </tr> </tbody> </table> <ol data-bbox="618 1122 1006 1276" style="list-style-type: none"> 3. Reconnect thermal device connector to control board socket. Connect power, turn sprayer ON and control knob 1/2 turn clockwise. If sprayer does not run, replace control board. 	Resistance Table:		Paint	0 ohms	Texture (240V)	3.9k ohms	Texture (110V)	6.2k ohms
Resistance Table:										
Paint	0 ohms									
Texture (240V)	3.9k ohms									
Texture (110V)	6.2k ohms									
<p data-bbox="29 1292 291 1317">Sprayer does not run at all</p> <p data-bbox="29 1330 291 1354">Display shows CODE 08</p> 	<p data-bbox="306 1292 603 1365">Check voltage supply to the sprayer (incoming voltage too low for sprayer operation)</p>	<ol data-bbox="618 1292 1006 1463" style="list-style-type: none"> 1. Set sprayer to OFF and disconnect power to sprayer. 2. Remove other equipment that uses the same circuit. 3. Locate a good voltage supply to avoid damage to electronics. 								

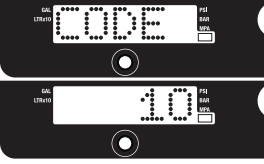
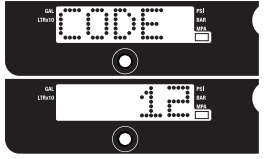
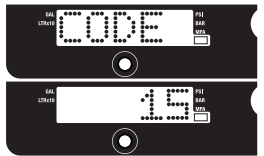
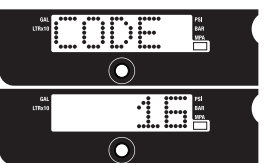
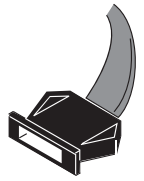
PROBLEM	CAUSE	SOLUTION
Sprayer does not run at all Display shows CODE 10 	Check to see if control board is over heating.	<ol style="list-style-type: none"> 1. Make sure motor air intake is not blocked. 2. Make sure fan has not failed. 3. Make sure control board is properly connected to back plate and that conductive thermal paste is used on power components. 4. Replace control board. 5. Replace motor.
Sprayer does not run at all Display shows CODE 12 	Excessive current protection enabled	<ol style="list-style-type: none"> 1. Cycle power on and off.
Sprayer does not run at all Display shows CODE 15 	Check the connections above the motor	<ol style="list-style-type: none"> 1. Set sprayer to OFF and disconnect power to sprayer. 2. Remove motor shroud. 3. Disconnect motor control and inspect for damage at connectors. 4. Reconnect motor control. 5. Turn power on. If code continues, replace motor.
Sprayer does not run at all Digital display shows CODE 16 	Check the connections. Control is not receiving a motor position sensor signal	<ol style="list-style-type: none"> 1. Turn power OFF. 2. Disconnect motor position sensor and inspect for damage at connectors.  <p style="text-align: right;">ti18685a</p> <ol style="list-style-type: none"> 3. Reconnect sensor. 4. Turn power ON. If code continues, replace motor.

Troubleshooting

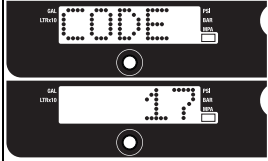
PROBLEM	CAUSE	SOLUTION
<p data-bbox="29 191 291 215">Sprayer does not run at all</p> <p data-bbox="29 228 291 253">Display shows CODE 17</p> 	<p data-bbox="306 191 604 269">Check voltage supply to the sprayer (sprayer plugged into wrong voltage)</p>	<ol data-bbox="619 191 1005 305" style="list-style-type: none"><li data-bbox="619 191 1005 245">1. Set sprayer to OFF and disconnect power to sprayer.<li data-bbox="619 253 1005 305">2. Locate a good voltage supply to avoid damage to electronics.

Sprayer Will Not Run

(See following page for steps)

Remove control box cover. Turn sprayer ON. Observe control board status light on control board.	
No light	
Once	Normal Operation
Light on Continuously	Control board commanding motor to run
Flashing	See Code section for further troubleshooting

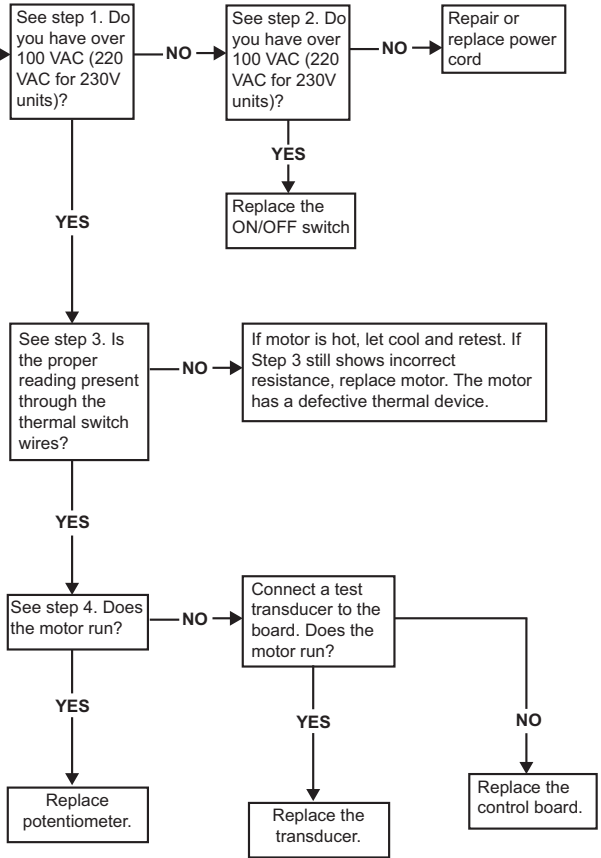

ti29440a

Troubleshooting

Troubleshooting

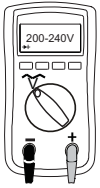

STEP 1:
Plug power cord in and turn switch ON. Connect probes to on/off switch. Turn meter to AC volts.

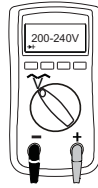
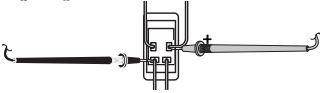

STEP 2:
Plug power cord in and turn switch ON. Connect probes to on/off switch. Turn meter to AC volts.

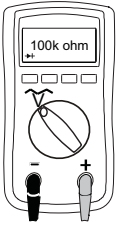
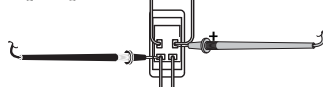

STEP 3:
Check motor thermal switch. Unplug yellow wires. Meter should read according to Resistance Table on page 30.

NOTE: Motor should be cool during reading.

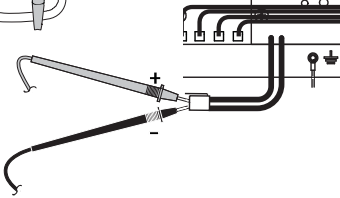

STEP 4:
Plug power cord in and turn switch ON. Disconnect potentiometer.

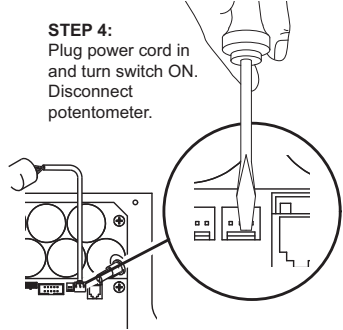

ti29441a

Sprayer Will Not Run

1. Perform **Pressure Relief Procedure**, page 13. Leave prime valve open and power switch OFF.
2. Remove control box cover so the control board status light can be viewed.

Troubleshooting procedure:

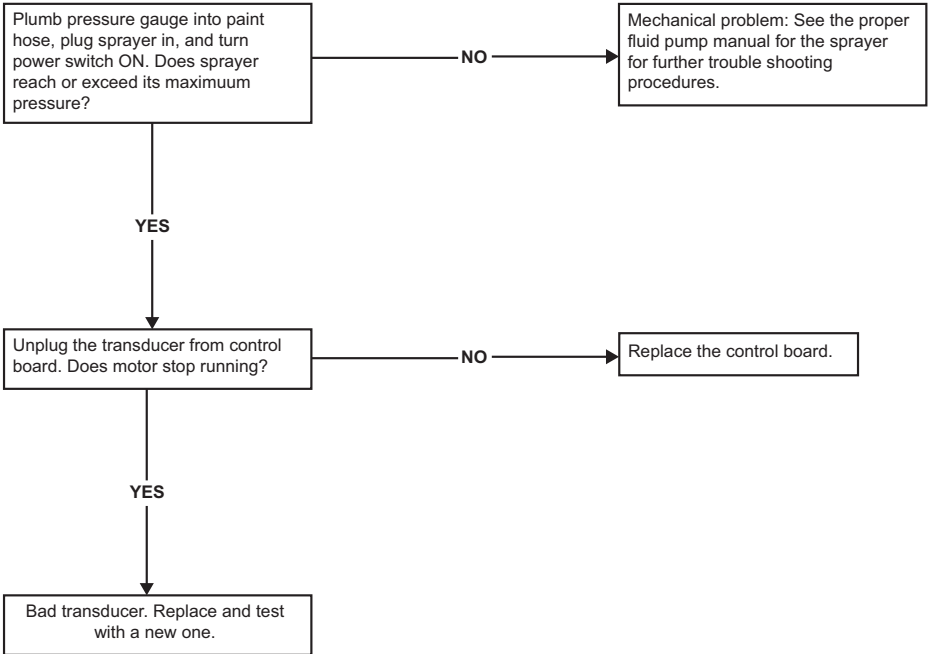

ti29442a

Parts

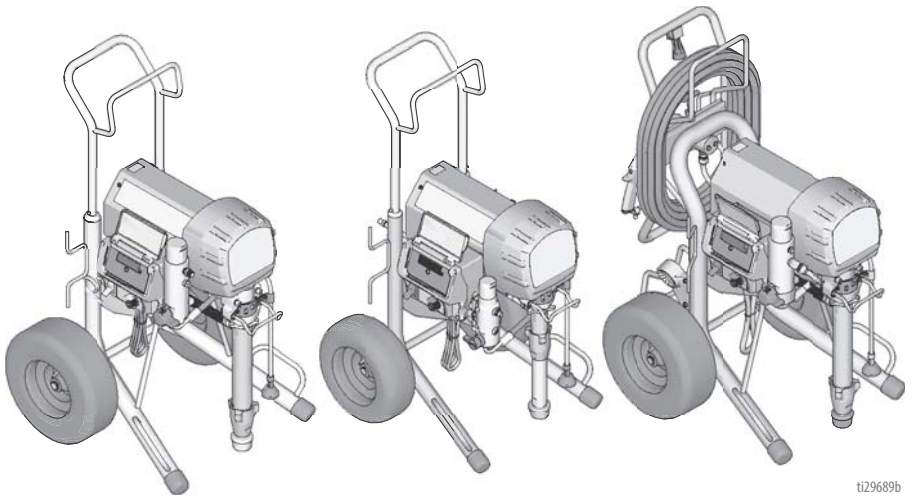

ti29689b

Parts List - Paint

Parts List - Paint

Ref.	Part	Description	Qty	Ref.	Part	Description	Qty
6	15C753	SCREW, mach torx, hex	5	83	17B215	HOUSING, bearing, <i>includes 12, 14, 24, 31, 77,</i>	1
8	15E891	CLIP, retaining	2			<i>108, 117</i>	
10	156306	WASHER, flat	2	84	257185	MOTOR, electric, <i>includes</i>	1
11*	119420	WHEEL, pneumatic	2			<i>126, 127</i>	
12	106115	WASH, lock, spring	4	85	241008	ROD, connecting, <i>includes</i>	1
14	110141	SCREW, cap, socket hd	4			<i>43</i>	
17	15C871	CAP, leg	2	87	241920	DEFLECTOR, threaded	1
18	109032	SCREW, mach, pnh	4	89	287289	GEAR, combination, <i>includes 28, 30</i>	1
22	116038	WASHER, wave spring	2	90	287283	HOUSING, drive, M1, <i>includes 6, 36, 90a</i>	1
24	111040	NUT, hex, flanged	6	90a	107089	WASHER, race, thrust	1
28	114672	WASHER, thrust	2	91	16Y598	PUMP, displacement <i>includes 41, 109</i>	1
30	114699	WASHER, thrust	1				
31	118444	SCREW, machine hex washer hd	2	93	244240	HOSE, coupled, <i>includes 87</i>	1
36	116191	WASHER, thrust	1	94	15M671	HOSE, coupled	1
37	100057	SCREW, cap, hex hd	4	99	287489	HANDLE, cart	1
41	164672	FITTING	1	108	16X770	SHIELD, pump rod	1
43	176817	SPRING, retaining	1	109	118494	PACKING, o-ring	1
44	176818	PIN, str, hdls	1	117	187437	LABEL, torque	1
48	189920	STRAINER, (1-11 1/2 npsm)	1	126	15D088	FAN, motor	1
55	16C457	HANGER, pail	1	127	115477	SCREW, mach, torx, pan, hd	1
56	192723	NUT, retaining	1	128▲	179960	CARD, medical alert (not shown)	1
57	17M498	BRACKET, motor shroud	1				
62	24Y429	FRAME, cart	1				
76	248214	TUBE, intake, <i>includes 109</i>	1				
77	278204	CLIP, spring	1				

▲ *Extra Danger and Warning tags and labels available for no cost.*

**253132 KIT, repair, tube*

Texture

Ref.	Torque
	40-45 in-lb (4.5 - 5.0 N•m)
	9-11 in-lb (1.0 - 1.2 N•m)
	200-230 in-lb (22.6 - 25.9 N•m)
	190-210 in-lb (21.4 - 23.7 N•m)

Ref.	Torque
	22-28 in-lb (2.4 - 3.1 N•m)
	25-30 ft-lb (33.8 - 40.6 N•m)
	70-80 ft-lb (94.9 - 108.4 N•m)
	65-85 in-lb (7.3 - 9.6 N•m)

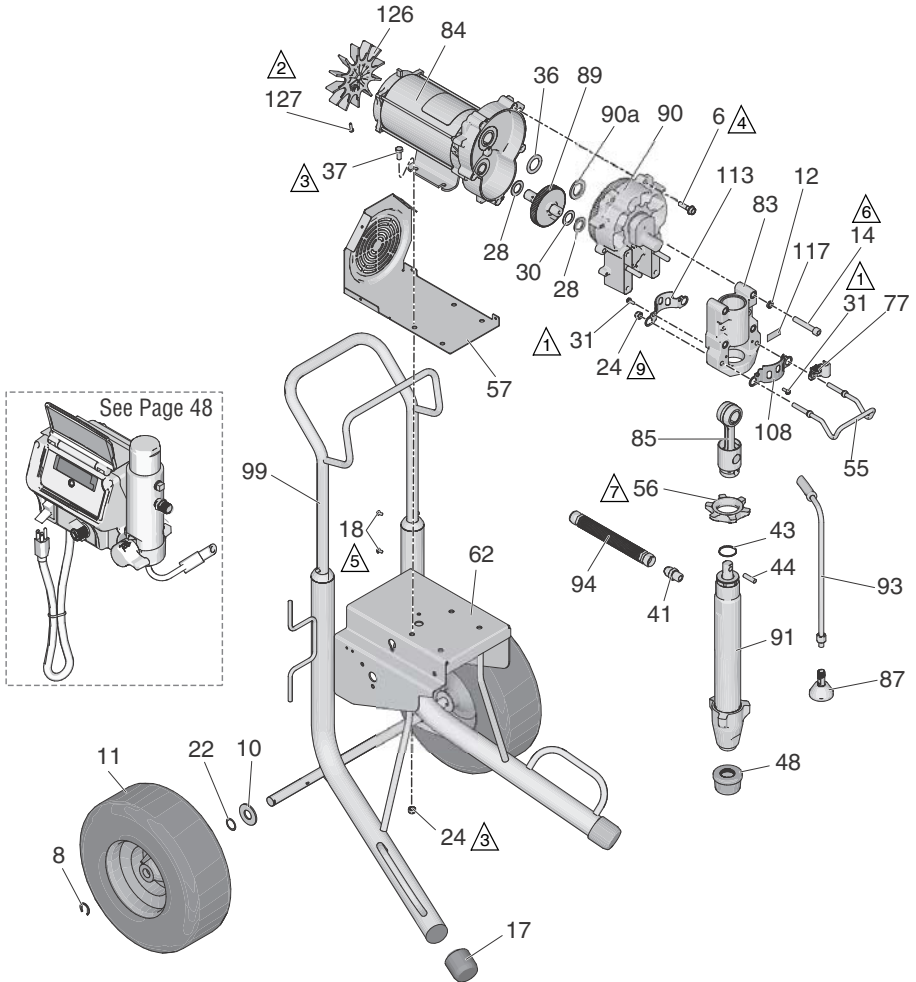

ti29801a

Parts List - Texture





Parts List - Texture





Ref.	Part	Description	Qty	Ref.	Part	Description	Qty
6	15C753	SCREW, mach torx, hex	5	84		MOTOR, electric, <i>includes 126, 127</i>	1
8	15E891	CLIP, retaining	2		257187	240V	
10	156306	WASHER, flat	2		257188	110V	
11*	119509	WHEEL, pneumatic	2	85	24V021	ROD, connecting, <i>includes 43, 44</i>	1
12	106115	WASH, lock, spring	4	87	241920	DEFLECTOR, threaded	1
14	114666	SCREW, cap, socket hd	4	89	287290	GEAR, combination, <i>includes 28, 30</i>	1
17	276974	CAP, leg	2	90	287295	HOUSING, drive, <i>includes 6, 36, 90a</i>	1
18	108795	SCREW, mach, pnh	4	90a	194173	WASHER, race, thrust	1
22	116038	WASHER, wave spring	2	91	249059	KIT <i>includes 41</i>	1
24	111040	NUT, hex, flanged	6	93	244240	HOSE, coupled, <i>includes 87</i>	1
28	114672	WASHER, thrust	2	94	17A073	HOSE, coupled	1
30	114699	WASHER, thrust	1	99	24A250	HANDLE, cart	1
31	118444	SCREW, machine hex washer hd	4	108	16X770	SHIELD, pump rod	1
36	116192	WASHER, thrust	1	113	15C762	SHIELD, pump rod	1
37	100057	SCREW, cap, hex hd	4	117	187437	LABEL, torque	1
41	117608	FITTING, pump	1	126	15D088	FAN, motor	1
43	119778	SPRING, retaining	1	127	115477	SCREW, mach, torx, pan, hd	1
44	183210	PIN, pump	1	128▲	179960	CARD, medical alert (not shown)	1
48	189920	STRAINER, (1-11 1/2 npsm)	1				
55	16C457	HANGER, pail	1				
56	193031	NUT, retaining	1				
57	17M498	BRACKET, motor shroud	1				
62	24Y428	FRAME, cart	1				
77	278204	CLIP, drain line	1				
83	17M679	HOUSING, bearing	1				

▲ *Extra Danger and Warning tags and labels available for no cost.*

**253131 KIT, repair, tube*

Texture Hose Reel

Ref.	Torque
	40-45 in-lb (4.5 - 5.0 N•m)
	9-11 in-lb (1.0 - 1.2 N•m)
	200-230 in-lb (22.6 - 25.9 N•m)
	190-210 in-lb (21.4 - 23.7 N•m)

Ref.	Torque
	25-30 ft-lb (33.8 - 40.6 N•m)
	130-150 in-lb (14.6 - 16.9 N•m)
	65-85 in-lb (7.3 - 9.6 N•m)
	70-80 ft-lb (94.9 - 108.4 N•m)

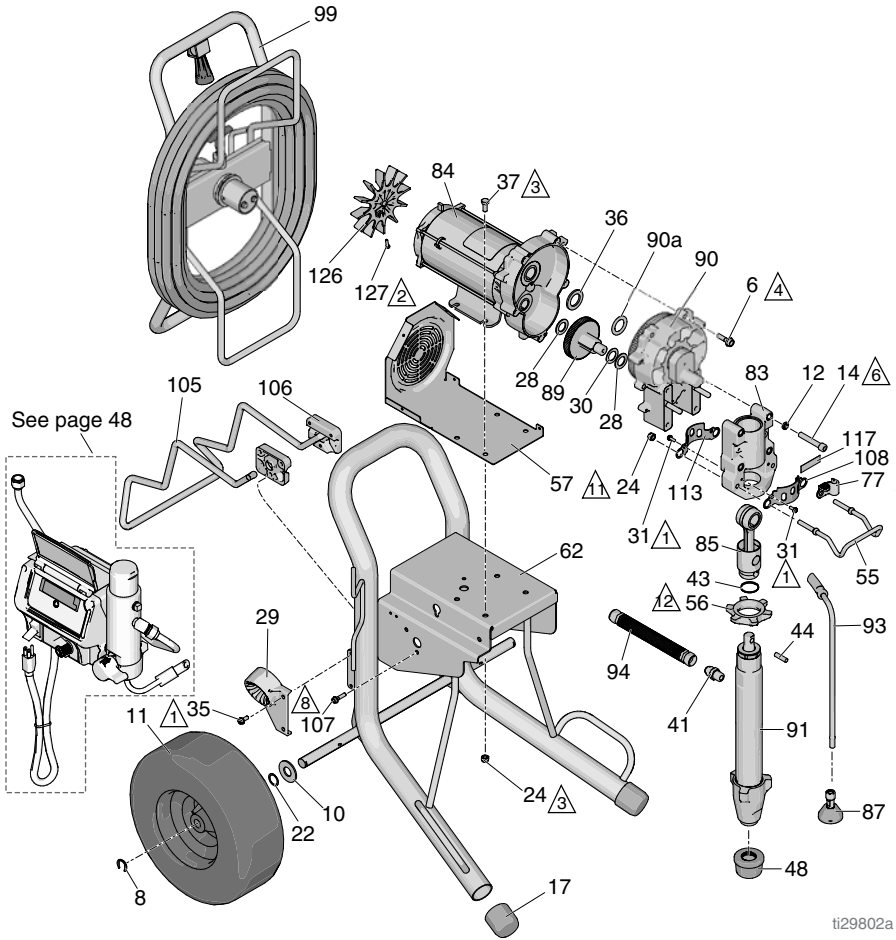

ti29802a

Parts List - Texture Hose Reel

Parts List - Texture Hose Reel

Ref.	Part	Description	Qty	Ref.	Part	Description	Qty
6	15C753	SCREW, mach, hex wash hd	5		257188	110V	
8	15E891	CLIP, retaining	2	85	24V021	ROD, connecting, <i>includes 43, 44</i>	1
10	156306	WASHER, flat	2	87	241920	DEFLECTOR, threaded	1
11*	119509	WHEEL, pneumatic	2	89	287290	GEAR, combination, <i>includes 28, 30</i>	1
12	106115	WASHER, lock (hi-collar)	4	90	287295	HOUSING, drive, <i>includes 6, 36, 90a</i>	1
14	114666	SCREW, cap, socket head	4	90a	194173	WASHER, race, thrust	1
17	276974	CAP, leg	2	91	249059	PUMP, displacement, <i>includes 41</i>	1
22	116038	WASHER, wave spring	2	93	244240	HOSE, drain, <i>includes 87</i>	1
24	111040	NUT, lock, insert	6	94	17A073	HOSE, coupled	1
28	114672	WASHER, thrust	2	99	17M778	HOSE, reel	1
29	278083	BRACKET, hose, wrap	1	105	16X698	HANGER, stand, cart	1
30	114699	WASHER, thrust	1	106	15C982	CAM, cart	2
31	118444	SCREW, mach, slot hex wash hd	4	107	114531	SCREW, mach, hex washer hd	4
35	117633	SCREW, slot hex wash hd	2	108	16X770	SHIELD, pump rod	1
36	116192	WASHER, thrust	1	113	15C762	SHIELD, pump rod	1
37	100057	SCREW, cap, hex hd	4	117	187437	LABEL, torque	1
41	117608	FITTING, pump	1	126	15D088	FAN, motor	1
43	119778	SPRING, retaining	1	127	115477	SCREW, mach, torx pan hd	1
44	183210	PIN	1	128▲	179960	CARD, medical alert (not shown)	1
48	189920	STRAINER, (1-11 1/2 npsm)	1				
55	16C457	HANGER, pail	1				
56	193031	NUT, retaining	1				
57	17M498	BRACKET, shroud, motor	1				
62	24Y426	FRAME	1				
77	278204	CLIP, drain line	1				
83	17M679	HOUSING, bearing	1				
84		MOTOR, electric, <i>includes 126, 127</i>	1				
	257187	240V					

* 253131 KIT, repair, tube

▲ Extra Danger and Warning tags and labels available for no cost.

Filter Paint

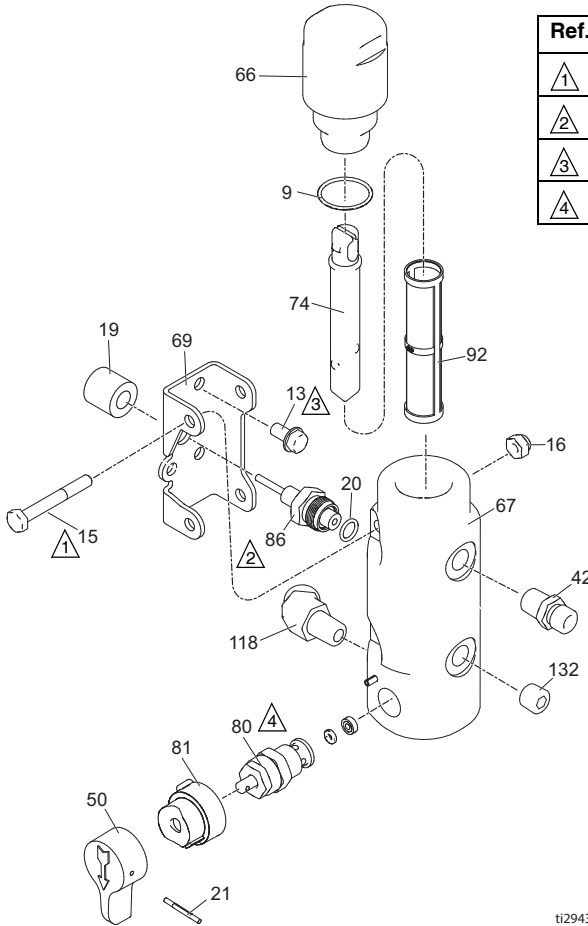







Ref.	Torque
△1	40-45 in-lb (4.5 - 5.1 N•m)
△2	35-45 ft-lb (47.4 - 61.0 N•m)
△3	100-120 in-lb (11.2 - 13.5 N•m)
△4	130-150 in-lb (14.6 - 16.9 N•m)

ti29433a

Ref.	Part	Description	Qty	Ref.	Part	Description	Qty
9	118133	PACKING, o-ring	1	74	15B071	INSERT, filter	1
13	107257	SCREW, cap, socket head	3	80	235014	VALVE, prime, <i>includes 21, 50, 81</i>	1
15	105170	SCREW, cap, socket head	2	81	224807	BASE, valve	1
16	102040	NUT, lock, hex	2	86	243222	TRANSDUCER, pressure control, <i>includes 20</i>	1
19	17C081	GROMMET, transducer	1	92		FILTER, fluid	1
20	111457	PACKING, o-ring	1	246425		30 mesh	
21	111600	PIN, grooved	1	246384		60 mesh, original equipment	
42	162453	FITTING	1	246382		100 mesh	
50	187625	HANDLE	1	246383		200 mesh	
66	287902	CAP, filter, <i>includes 74</i>	1	118	119789	FITTING, elbow	1
67	15T811	MANIFOLD, fluid	1	132	100721	PLUG, pipe	1
69	16X407	BRACKET, mount, filter	1				

Control Box

Control Box

Ref.	Torque
	10-15 in-lb (1.1 - 1.7 N•m)
	40-45 in-lb (4.5 - 5.0 N•m)
	9-11 in-lb (1.0 - 1.2 N•m)
	200-230 in-lb (22.6 - 25.9 N•m)
	30-35 in-lb (3.3 - 3.9 N•m)
	2-3 in-lb (0.23 - 0.34 N•m)

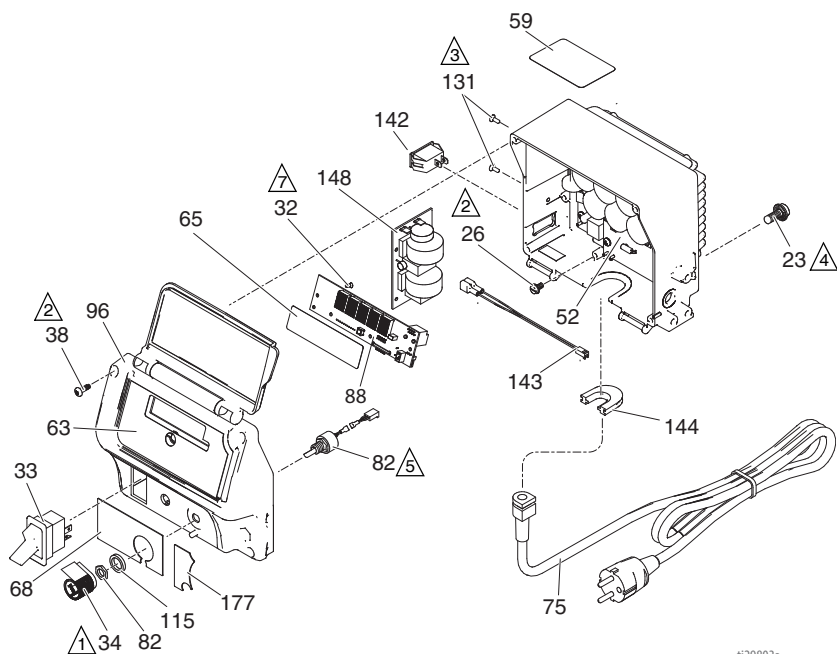

ti29803a





Parts List - Control Box

Ref.	Part	Description	Qty	Ref.	Part	Description	Qty
23	117791	SCREW, cap, flange head	2	15D528	EU CEE 7/7 240V		
26	114391	SCREW, grounding	1	82	256219	POTENTIOMETER, assembly	1
32	115522	SCREW, mach, pnh	3	88	16Y496	DISPLAY, <i>includes 32</i>	1
33	15C979	SWITCH, rocker, 110V	1	96	17A516	COVER, control, <i>includes 32, 38, 63, 68, 88, 177</i>	1
	15D527	SWITCH, rocker, 230V	1	115	15C973	GASKET	1
34	116167	KNOB, potentiometer	1	131	119288	SCREW/PLUG	2
38	16V095	SCREW, #10, taptite phil	4	142	SWITCH/PLUG		1
52		CONTROL, board, <i>includes 23, 26, 60, 131, 142, 144</i>	1		16T483	240V	
	24P847	110V models			120059	110V (15/20 amp)	
	24P848	240V models		143	15G935	CONNECTOR, electrical	1
59▲	16G596	LABEL, warning, Europe	1	144	16T546	STRAIN RELIEF	1
63	17A449	LABEL, LCD	1	148	24R598	BOARD, filter (230V models)	1
65	16Y796	LABEL, LED	1		24R597	BOARD, filter (110V models)	1
68	17A446	LABEL, control	1	177	17A448	LABEL, blank, elec, std	1
75		CORD, power	1				
	15D530	110V					

▲ *Extra Danger and Warning tags and labels available at no cost.*

Texture Filter

Texture Filter

Ref.	Torque
 1	90-110 in-lb (10.1 - 12.4 N•m)
 2	35-45 ft-lb (47.4 - 61.0 N•m)
 3	190-210 in-lb (21.4 - 23.7 N•m)
 4	100-120 in-lb (11.2 - 13.5 N•m)
 5	38-42 ft-lb (51.5 - 56.9 N•m)

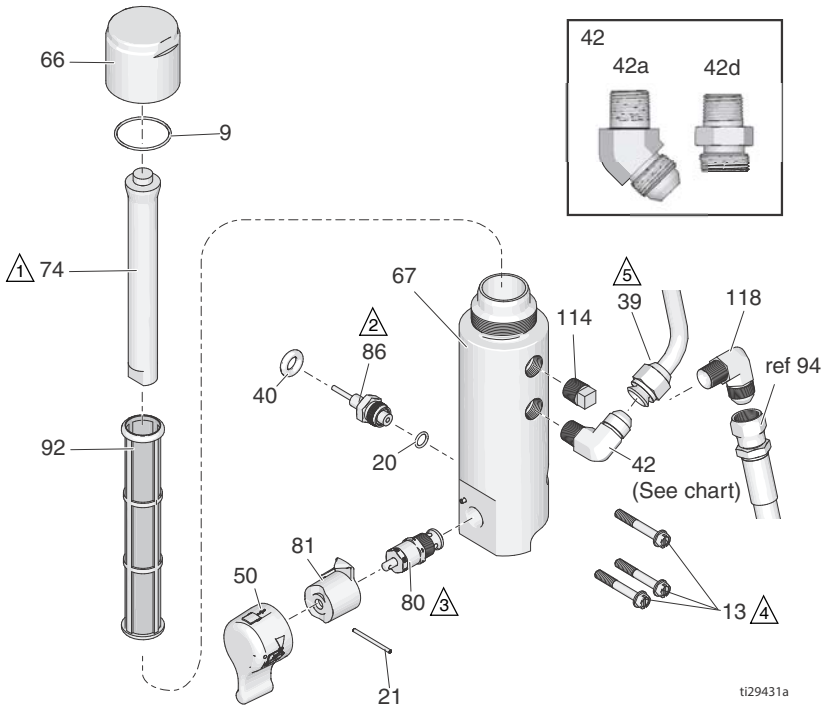

Ref.	Part	Description	Qty	Ref.	Part	Description	Qty
9	117285	PACKING, o-ring	1	74	15C766	TUBE, diffusion	1
13	16U013	SCREW, cap, socket head	3	80	24B156	VALVE, prime	1
20	111457	PACKING, o-ring	1	81	24A382	BASE, valve	1
21	15C972	PIN, grooved	1	86	243222	TRANSDUCER, pressure control, <i>includes 20</i>	1
39	24J081	TUBE, formed	1	92		FILTER, fluid	1
40	121889	GROMMET, transducer	1		244071	30 mesh	
42		FITTING	1		244067	60 mesh, original equipment	
42a	122533	FITTING			244068	100 mesh	
42d	196178	FITTING			244069	200 mesh	
50	24E234	KIT, handle, <i>includes 21, 81</i>	1	114	104813	PLUG, pipe, 3/8	1
66	15C765	CAP, filter	1	118	125926	FITTING, elbow	1
67	16T543	BASE, filter	1				

Texture Hose Reel

Ref.	Torque
△1	130-150 in-lb (14.6 - 16.9 N•m)
△2	25-35 ft-lb (33.8 - 47.4 N•m)
△3	120-130 in-lb (13.5 - 14.6 N•m)
△4	38-42 ft-lb (51.5 - 56.9 N•m)

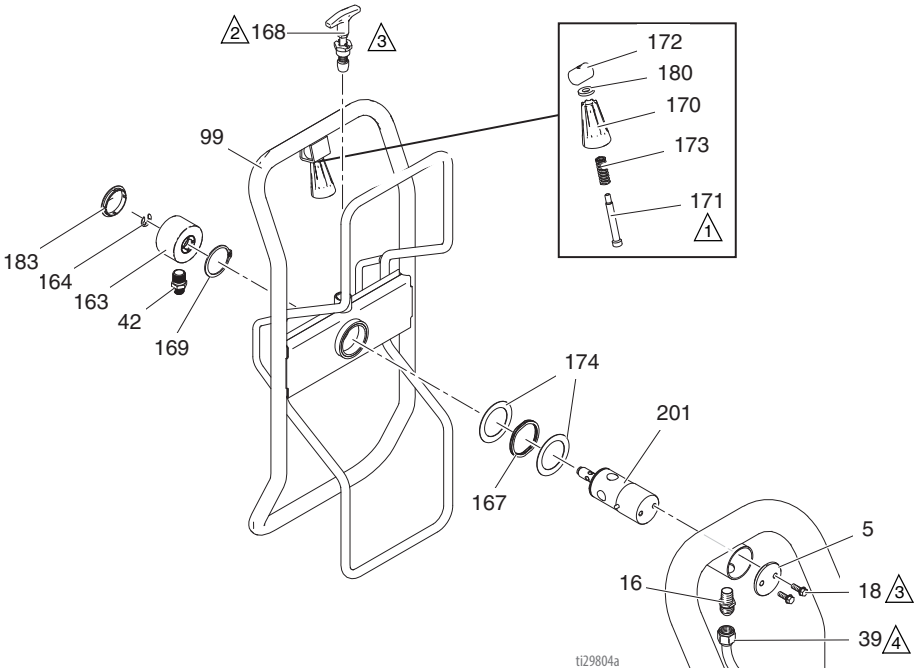

Ref.	Part	Description	Qty	Ref.	Part	Description	Qty
5	16C975	PLATE, pivot mount	1	169	122524	RING, retaining, external	1
16	121311	FITTING, connector, NPT x JIC	1	170	278085	HANDLE, swivel	1
18	260212	SCREW, hex washer hd	2	171	122518	PIN	1
39	24J081	TUBE, formed, ultra, platinum	1	172	15X618	NUT, pin	1
42	196178	ADAPTER	1	173	122542	SPRING	1
99	24B691	REEL, hose	1	174	122607	WASHER, flat	2
163	24B248	CAP, swivel, complete	1	180	122669	WASHER	1
164	122347	RING, retaining, external	1	183	122787	CAP	1
167	122534	SPRING, wave	1	201	24E016	TUBE, hose reel, pivot, includes 16	1
168	24E400	PIN, pop, lock out	1				

Wiring Diagram

Wiring Diagram

110V

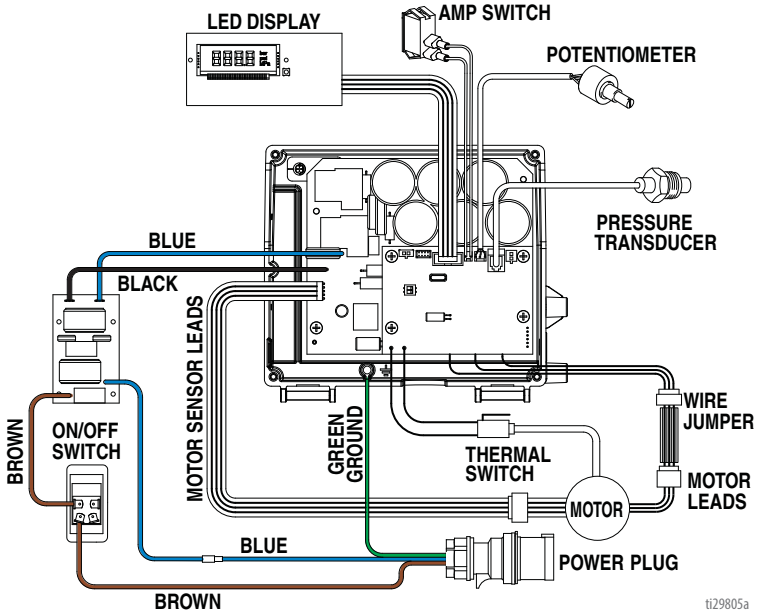

240V

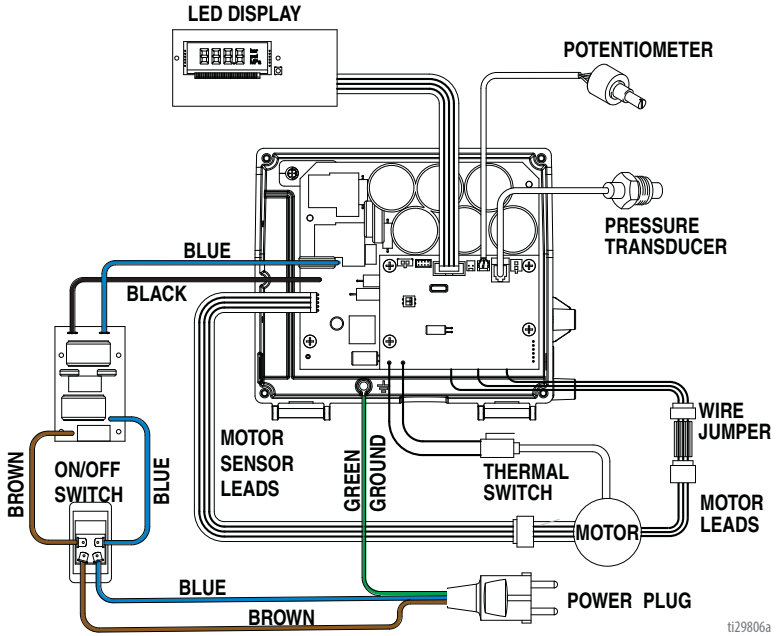

Technical Data

Paint Sprayers		
	US	Metric
Sprayer		
Maximum Working Pressure	3300 psi	227 bar
Maximum Delivery	0.95 gpm	3.6 lpm
Maximum Tip Size	0.031 in.	0.031 in.
Fluid Outlet npsm	1/4 in.	1/4 in.
Cycles	226 per gallon	60 per liter
Generator Minimum	5000 W	5000 W
110V, A, Hz	15, 50/60, 1 Ø	
230V, A, Hz	10, 50/60, 1 Ø	
Dimensions		
Weight:	87 lb	39 kg
Height:	28.5 in. (Handle down) 38.8 in. (Handle up)	72.4 cm (Handle down) 98.4 cm (Handle up)
Length:	25.2 in.	64 cm
Width:	22.2 in.	56.4 cm
Wetted parts		
	zinc- and nickel-plated carbon steel, nylon, stainless steel, PTFE, Acetal, leather, UHMWPE, aluminum, tungsten carbide, PEEK, brass	
Noise Level:		
Sound Power	91 dBa*	91 dBa*
Sound Pressure	82 dBa*	82 dBa*
	*per ISO 3744; measured at 3.1 ft	*per ISO 3744; measured at 1 m

Texture Sprayers

	US	Metric
Sprayer		
Maximum Working Pressure	3300 psi	227 bar
Maximum Delivery		
110V Models	1.35 gpm	5.1 lpm
230V Models	1.2 gpm	4.5 lpm
Maximum Tip Size		
110V Models	0.039 in.	0.039 in.
230V Models	0.035 in.	0.035 in.
Fluid Outlet npsm	3/8 in.	3/8 in.
Cycles	110 per gallon	29 per liter
Generator Minimum	5000 W	5000 W
110V, A, Hz	20/15, 50/60	20/15, 50/60
230V, A, Hz	10, 50/60	10, 50/60
Dimensions		
Weight:		
Stand	118 lb	54 kg
Hose Reel	140 lb	64 kg
Height:		
Stand	29.5 in. (Handle down) 40.2 in. (Handle up)	74.9 cm (Handle down) 102.1 cm (Handle up)
Hose Reel	39 in.	99 cm
Length:		
Stand	26 in.	66 cm
Hose Reel	28 in.	71 cm
Width:		
Stand	24 in.	61 cm
Hose Reel	24 in.	61 cm
Wetted parts		
	zinc- and nickel-plated carbon steel, nylon, stainless steel, PTFE, Acetal, leather, UHMWPE, aluminum, tungsten carbide, PEEK, brass	
Noise Level:		
Sound Power	91 dBa*	91 dBa*
Sound Pressure	82 dBa*	82 dBa*
	*per ISO 3744; measured at 3.1 ft	*per ISO 3744; measured at 1 m

All written and visual data contained in this document reflects the latest product information available at the time of publication.
The manufacturer reserves the right to make changes at any time without notice.
Original instructions. This manual contains English. MM 3A4168

Copyright 2016, All manufacturing locations are registered to ISO 9001.

Revision B, January 2017