

Muskoka Chair

Assembly Instructions

1" Thickness 5½" Arm & Rail Width



1032 Henshaw Lake Road, Box 494, Port Carling, ON P0B 1J0
muskokachair@outlook.com • 705-706-3836



www.muskokachair.com



Muskoka Chair Assembly Instructions

- Tools Needed:** Cordless Drill
#2 Robertson Bit
9/16" Socket or Adjustable Wrench

Tips:

Separate all parts in kit box into five sections (as marked)

Section A	Rail Assembly	14 parts 1" x 5½" Pages 4 - 8 4 - 1½" Round Head Screws 22 - 1½" Flat Head Screws
Section B	Back Support Assembly	5 parts Pages 9 - 10 4 - 2" Flat Head Screws 2 - 1½" Flat Head Screws
Section C	Chair Back Assembly	11 parts Pages 11 - 17 11 - 1½" Round Head Screws 14 - 2" Flat Head Screws
Section D	Arm and Front Leg Assembly	8 parts Pages 18 - 27 6 - 2" Flat Head Screws 12 - 1½" Round Head Screws 4 - 2" Hex Head Bolt 4 Washers 4 Nuts
Section E	Front Plate "Install" Only	1 part Page 28 - 30 4 - 1½" Round Head Screws
Attach back support to rail		2 - 2½" Carriage Bolts 2 - Washers 2 - Nuts
Attach back to rail and back support		6 - 2" Flat Head Screws
Attach arm back support		2 - 2" Flat Head Screws

If all parts and hardware are accounted for, lets begin.
If not call 1-705-706-3836 for assistance.

Part A - Rail Assembly, 16 Parts

1" x 5½" Muskoka Chair

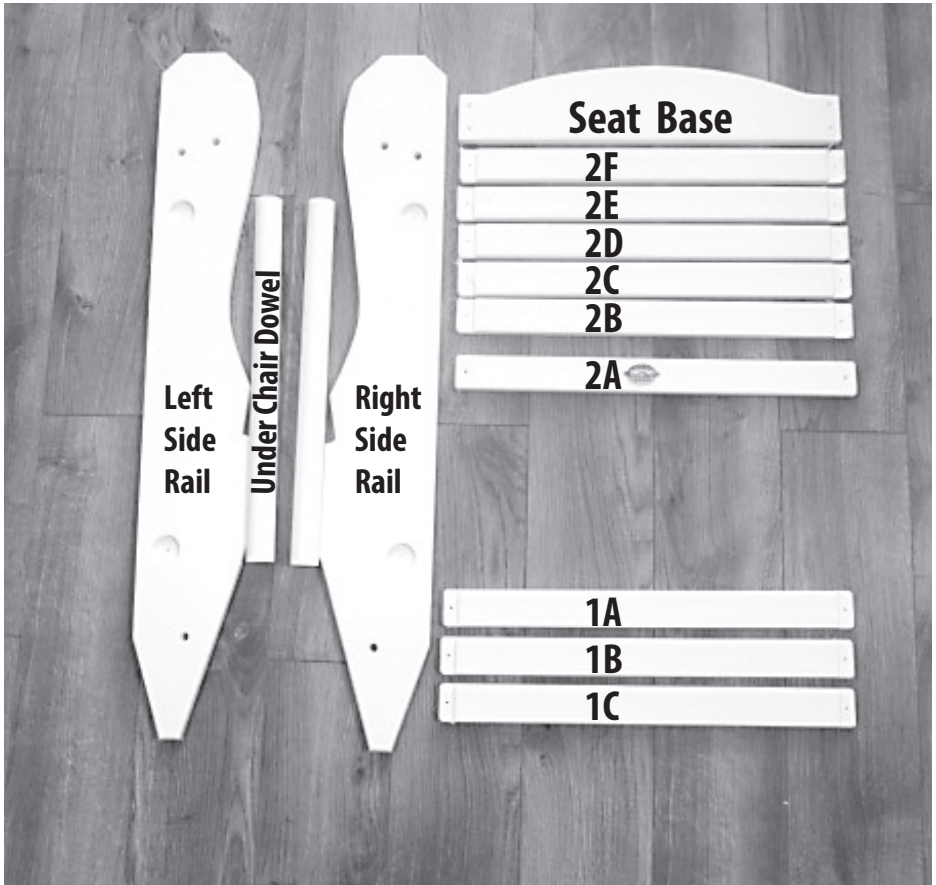

Part A - Rail Assembly, continued

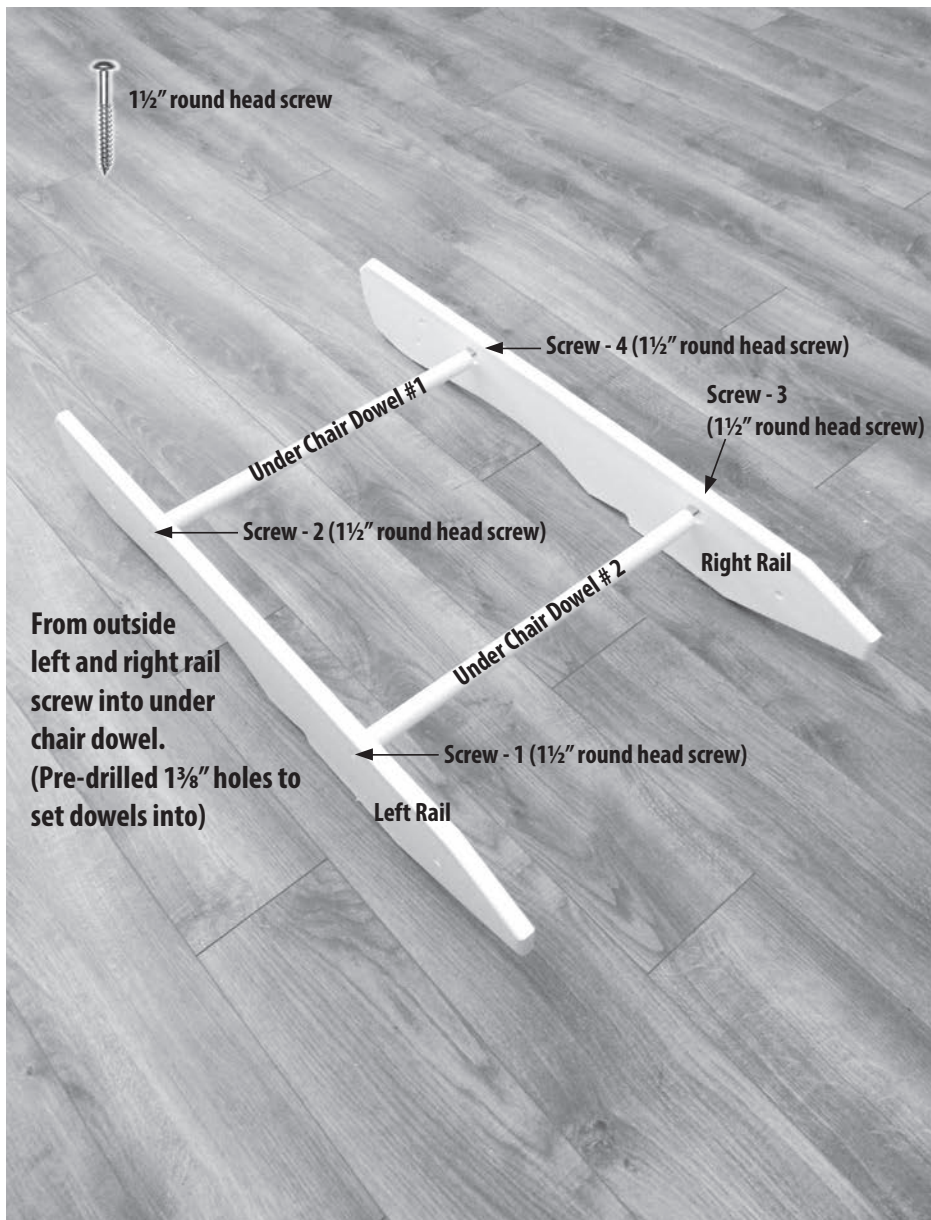

Part A - Rail Assembly, continued

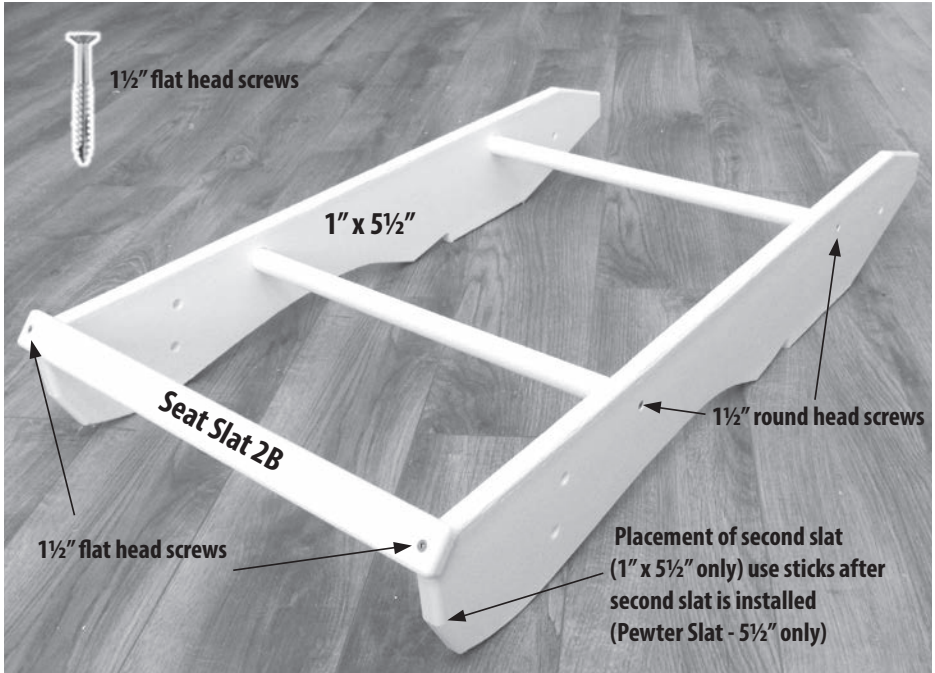

Part A - Rail Assembly, continued

1" x 5½" Muskoka Chair

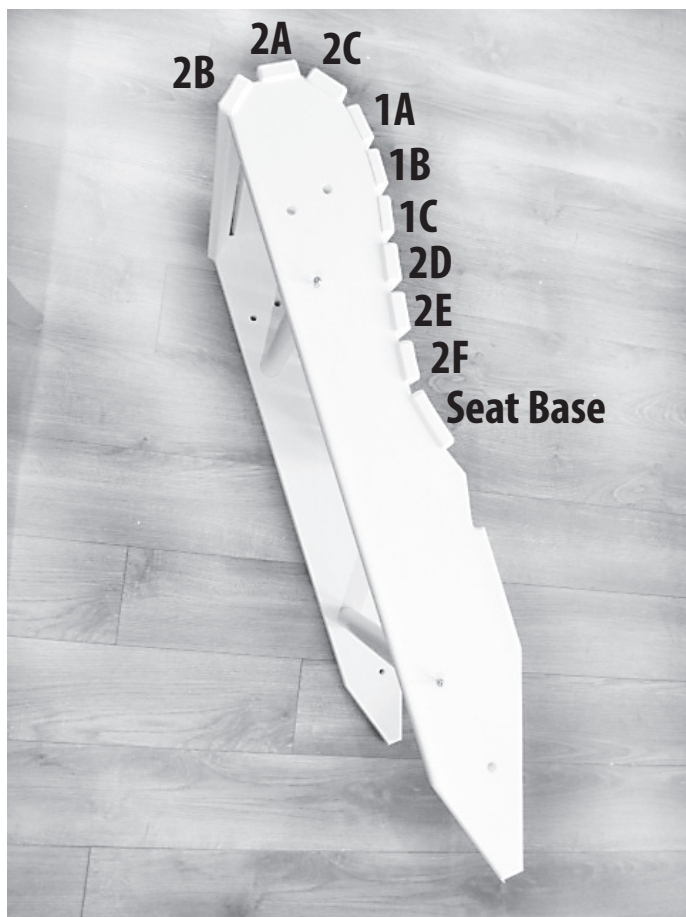

22 - 1½'
Flat Head
Screws



Part A - Rail Assembly, continued

1" x 5½" Muskoka Chair



Part B - Back Support Assembly, 5 parts

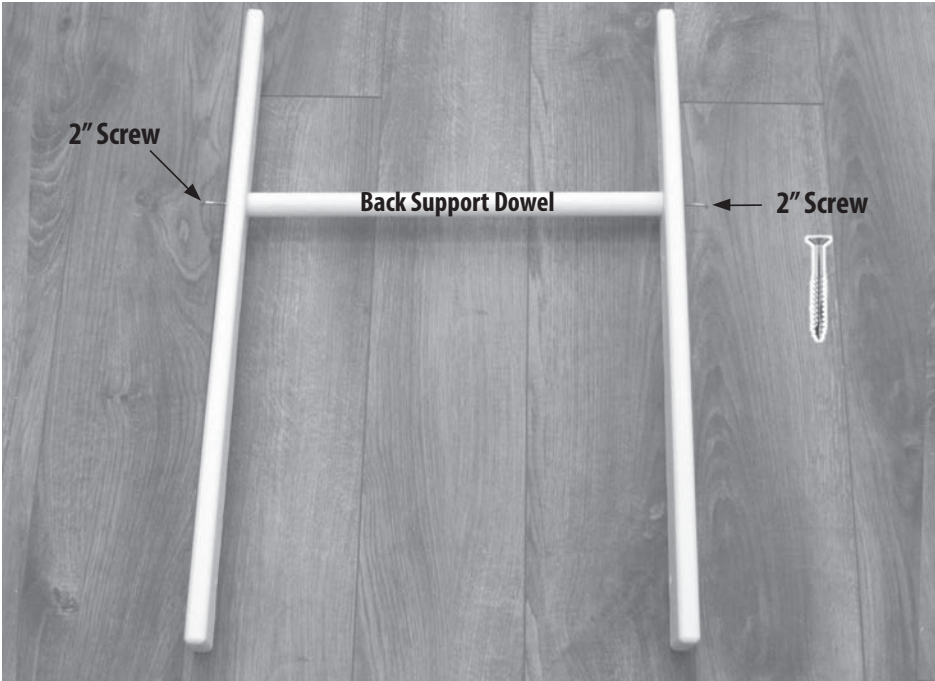
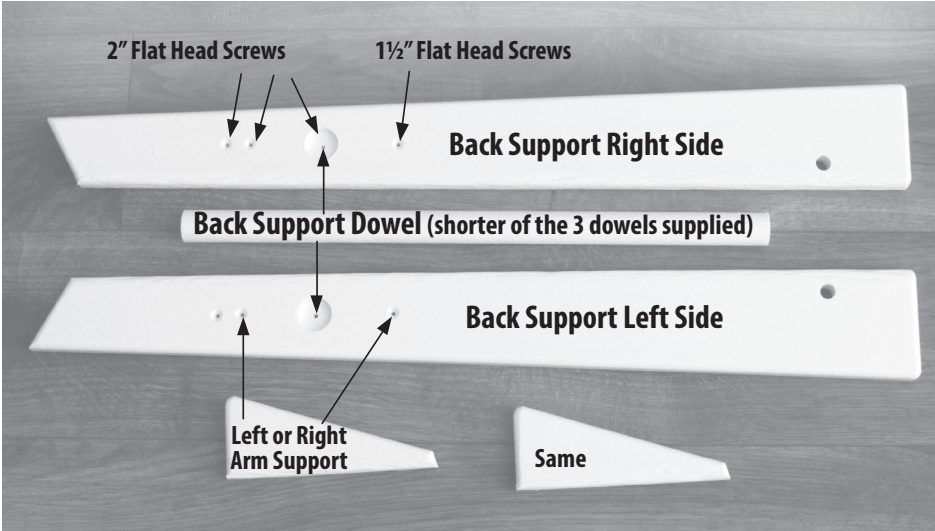

Part B - Back Support Assembly, 5 parts

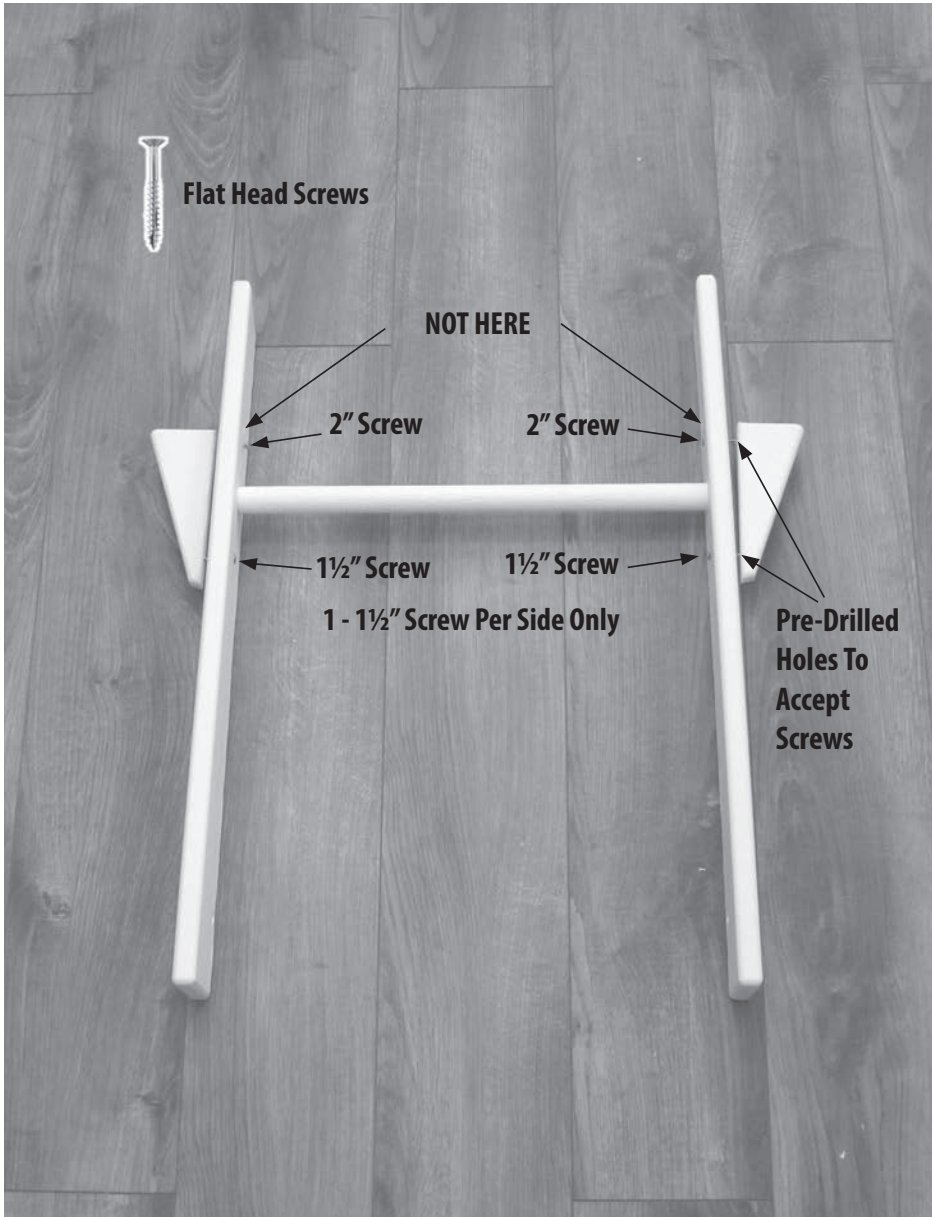

Part C - Chair Back Assembly, 11 parts

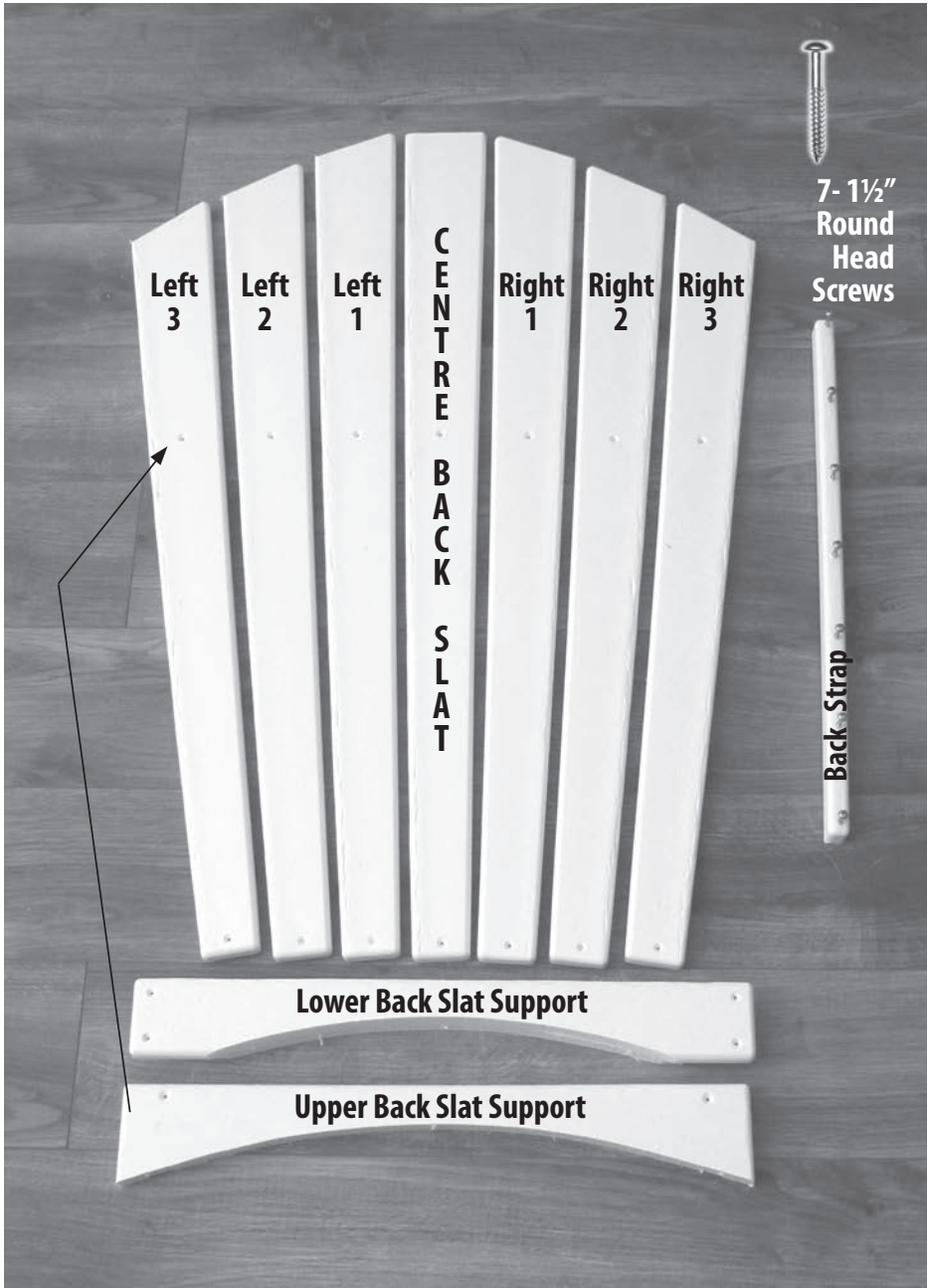

Part C - Chair Back Assembly, 11 parts

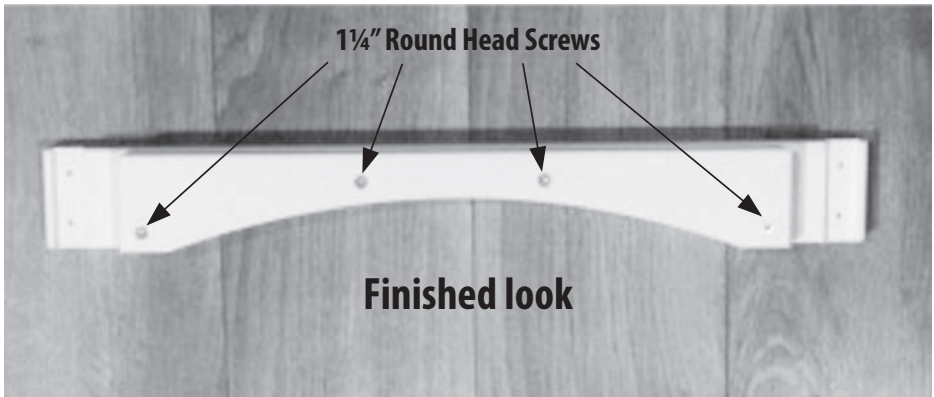
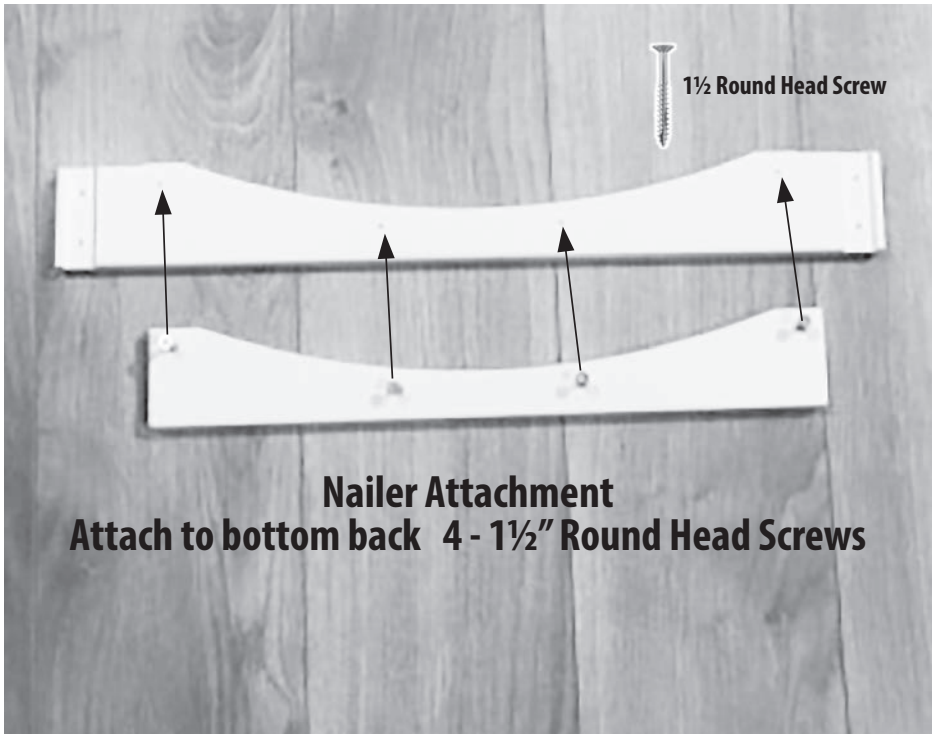

Part C - Chair Back Assembly, 11 parts

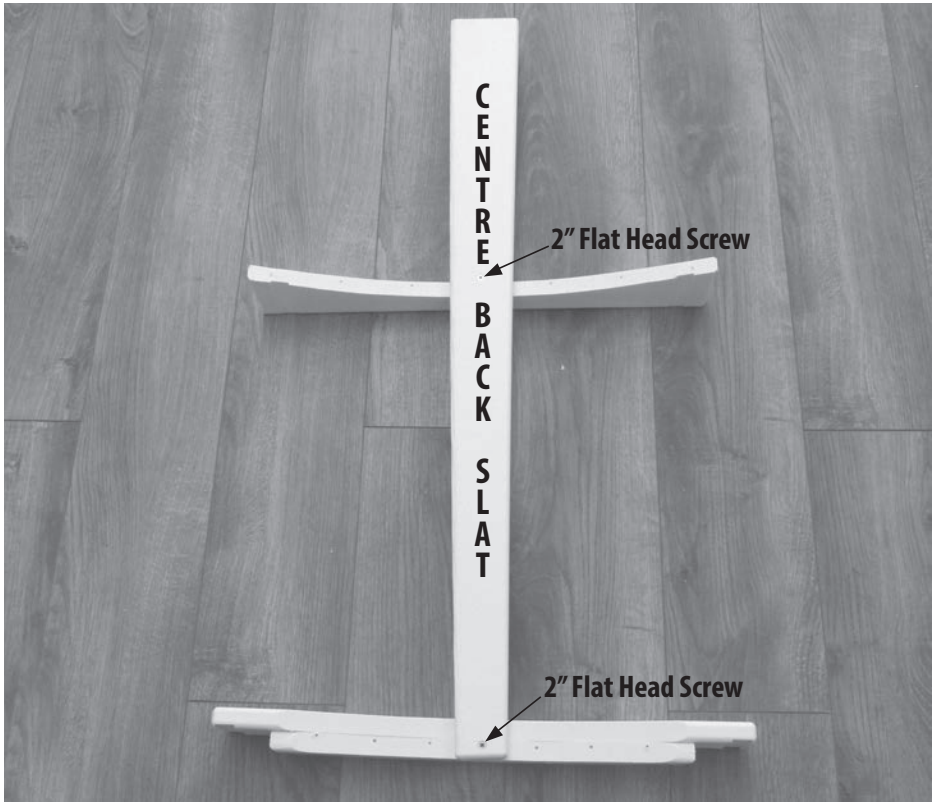
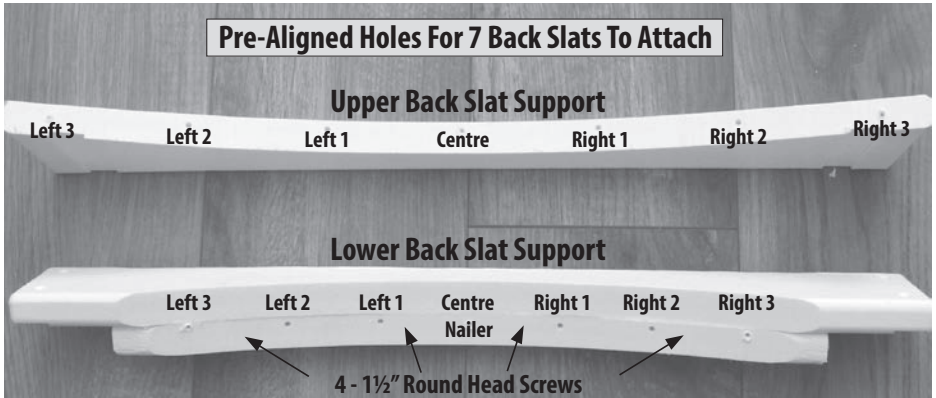

Part C - Chair Back Assembly, 11 parts

Install 14 - 2" Flat Head Screws

"Tip" Screw through back slat, then place screw tip in proper hole.

If having trouble aligning holes, just twist back

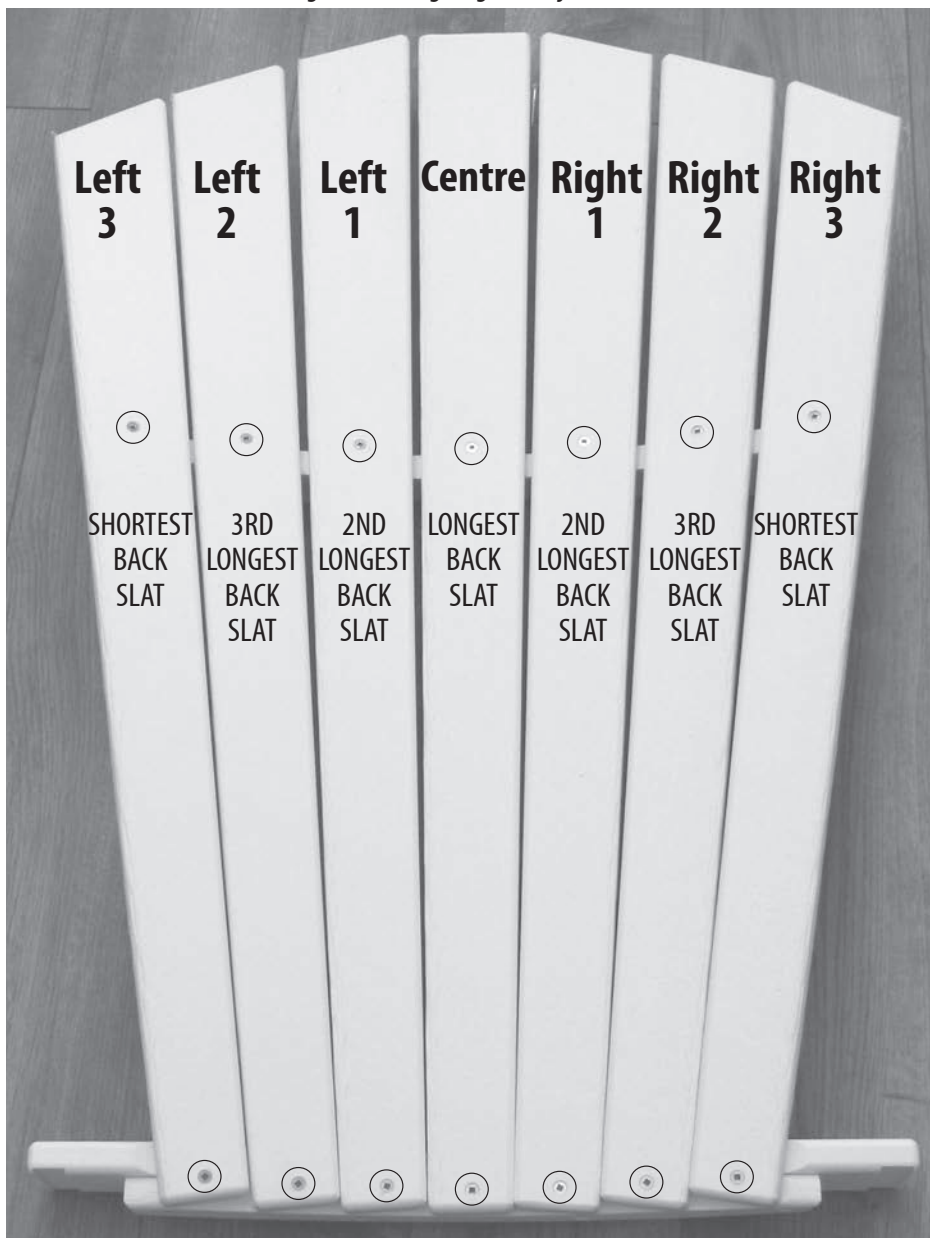

Part C - Chair Back Assembly, 11 parts

Flip back over, screw centre of back strap to centre of back



Part C - Chair Back Assembly, 10 parts

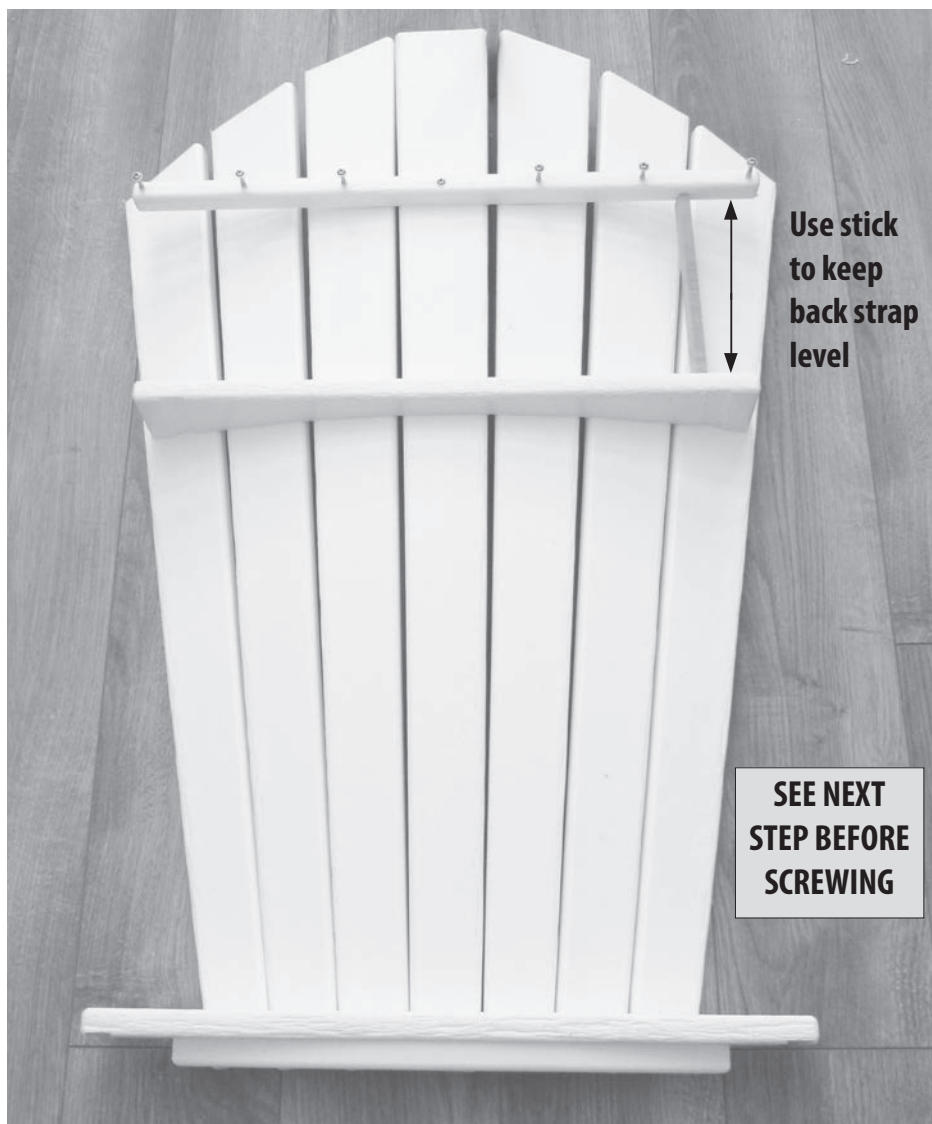

Part C - Chair Back Assembly, 10 parts

Use sticks to separate back slats evenly
If tight use screw driver to spread back slats



Back Is Complete

Part D - Arm and Front Leg Assembly, 8 parts

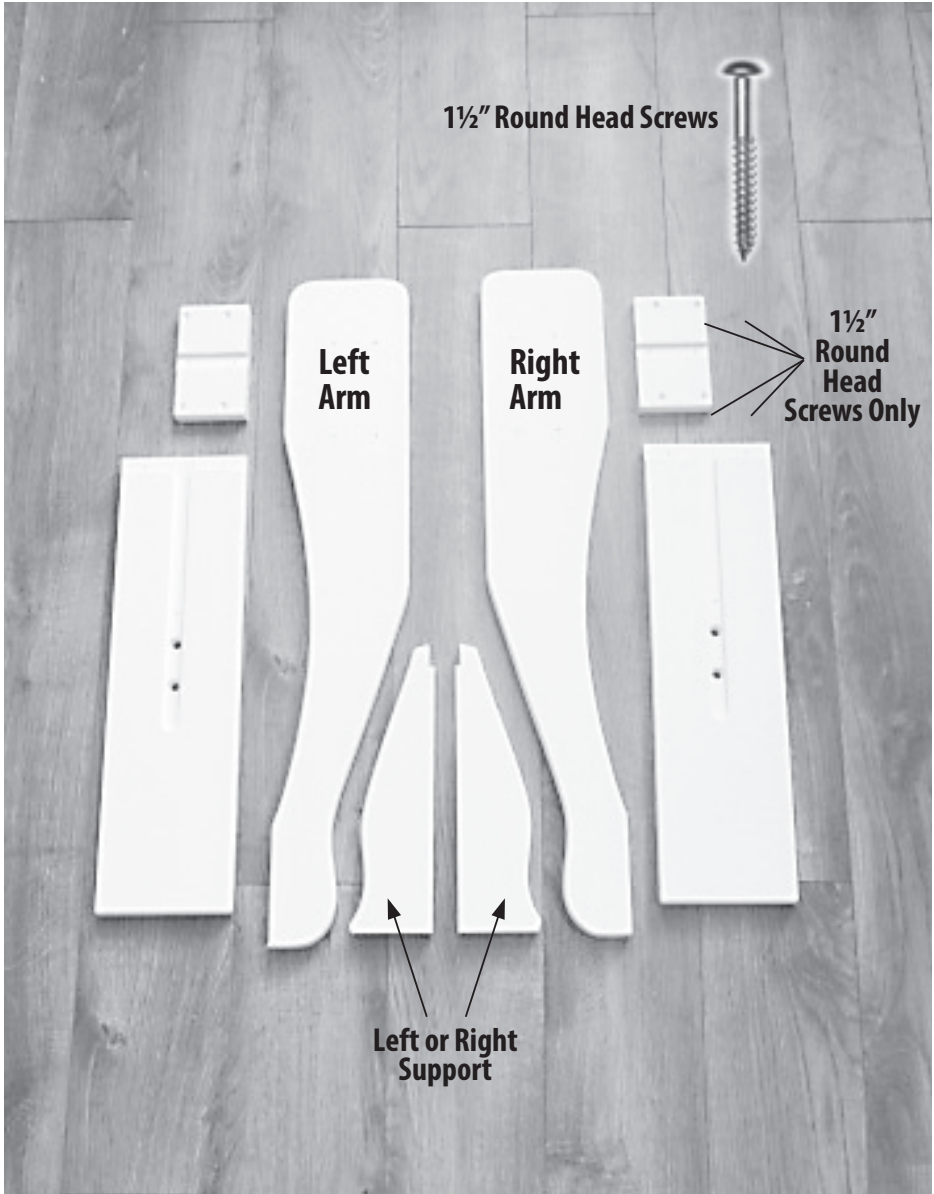

Part D - Arm and Front Leg Assembly, 8 parts



Part D - Arm and Front Leg Assembly, 8 parts

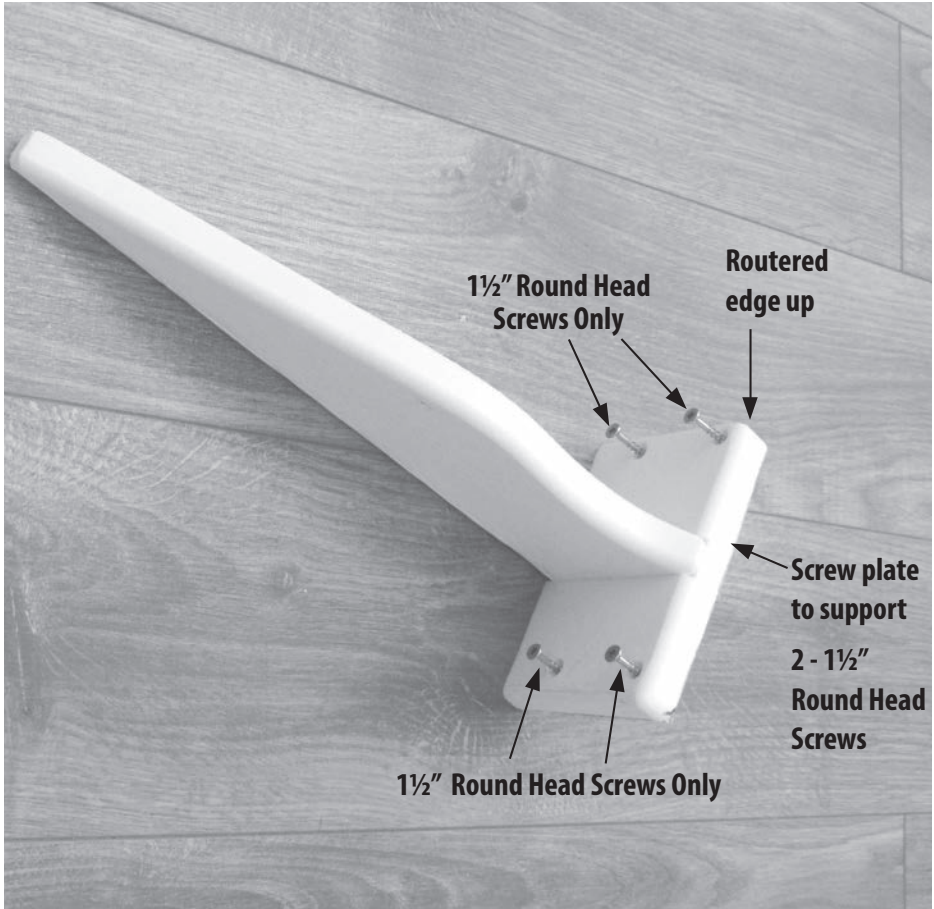

Part D - Arm and Front Leg Assembly, 8 parts

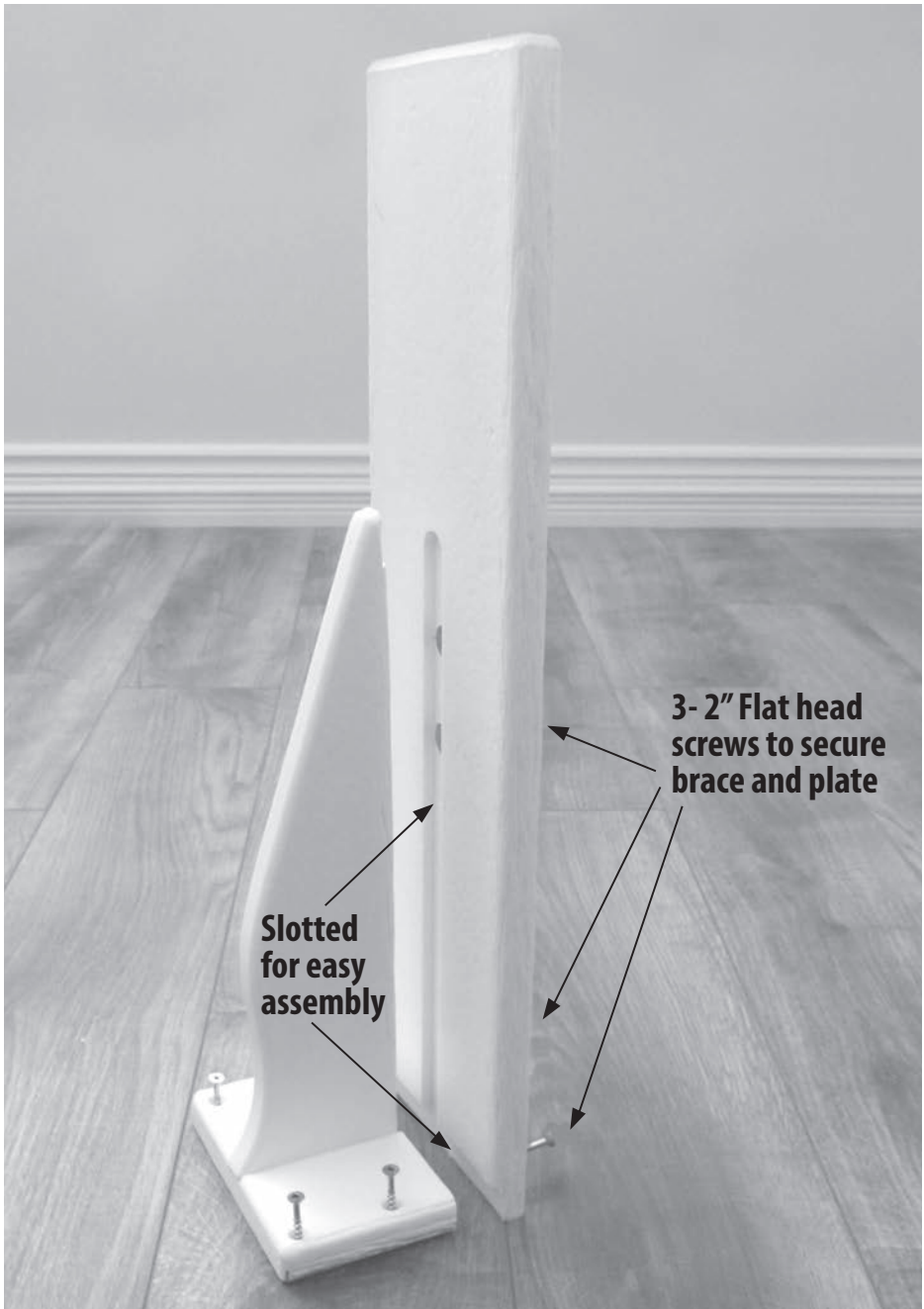

Part D - Arm and Front Leg Assembly, 8 parts

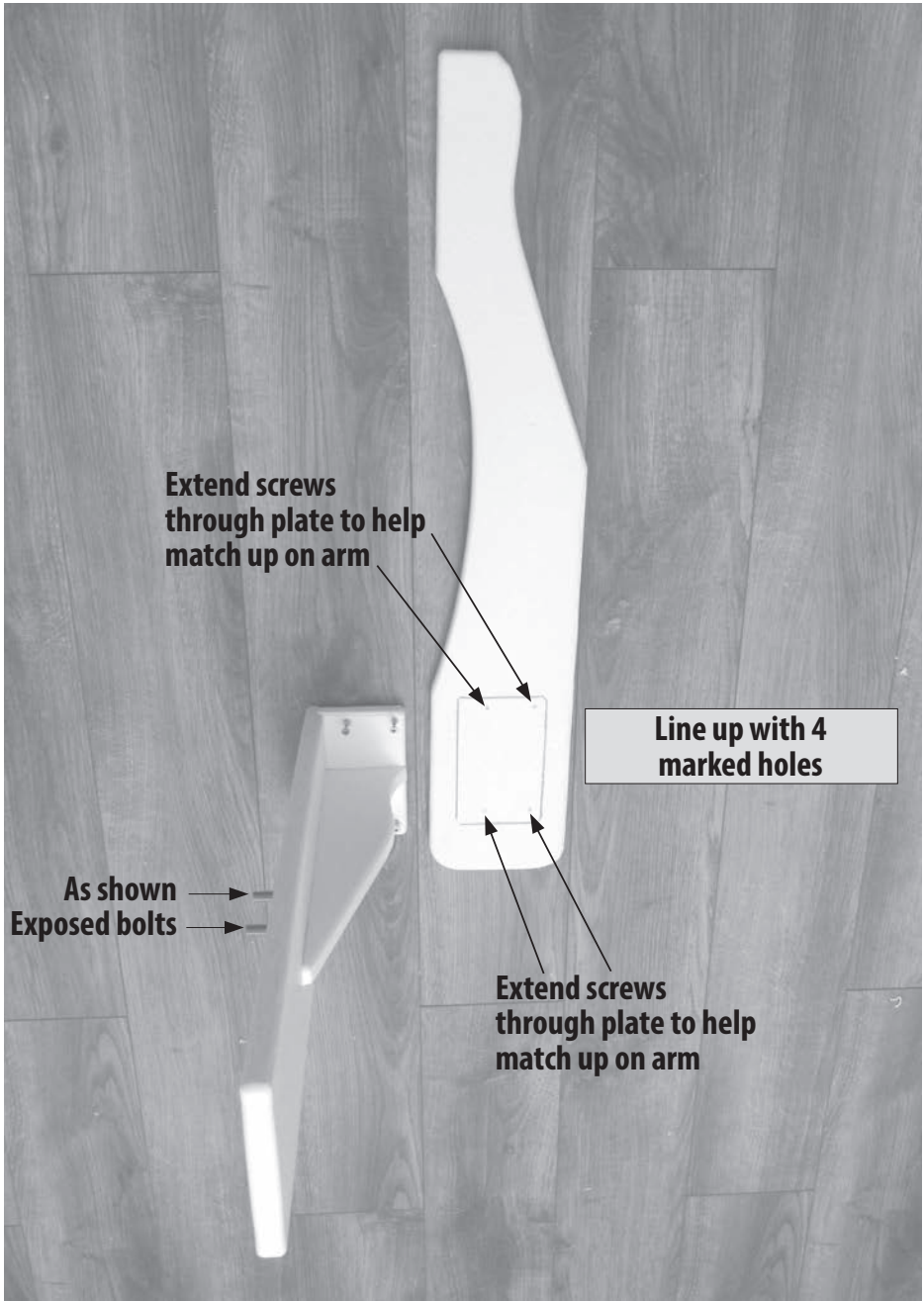

Part D - Arm and Front Leg Assembly, 8 parts

Finished Left Arm Assembly



Same Process For Right Side

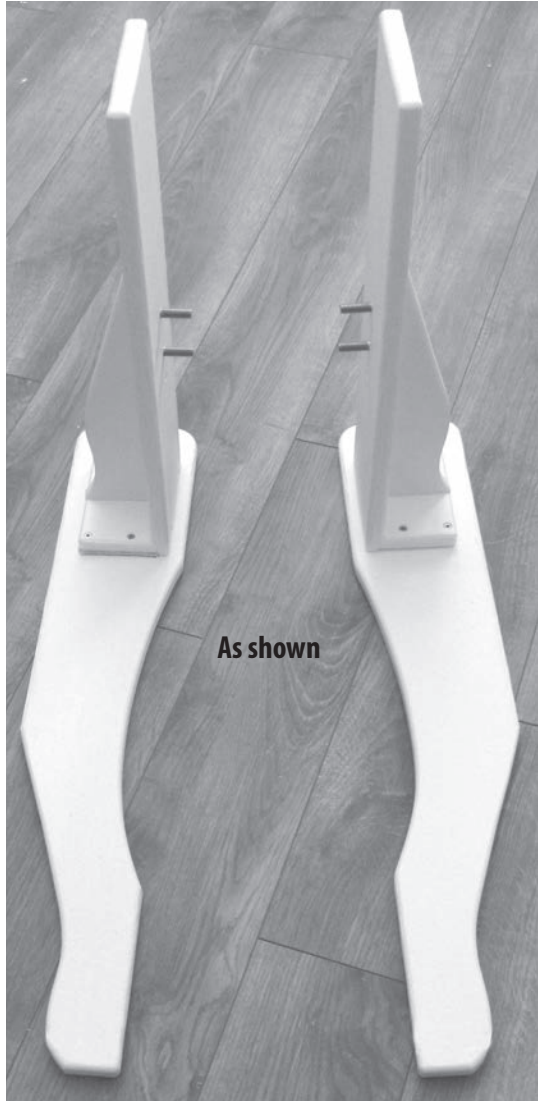

Part D - Arm and Front Leg Assembly, 8 parts

Muskoka Chair Assembly Time... 5 Minutes To Go!

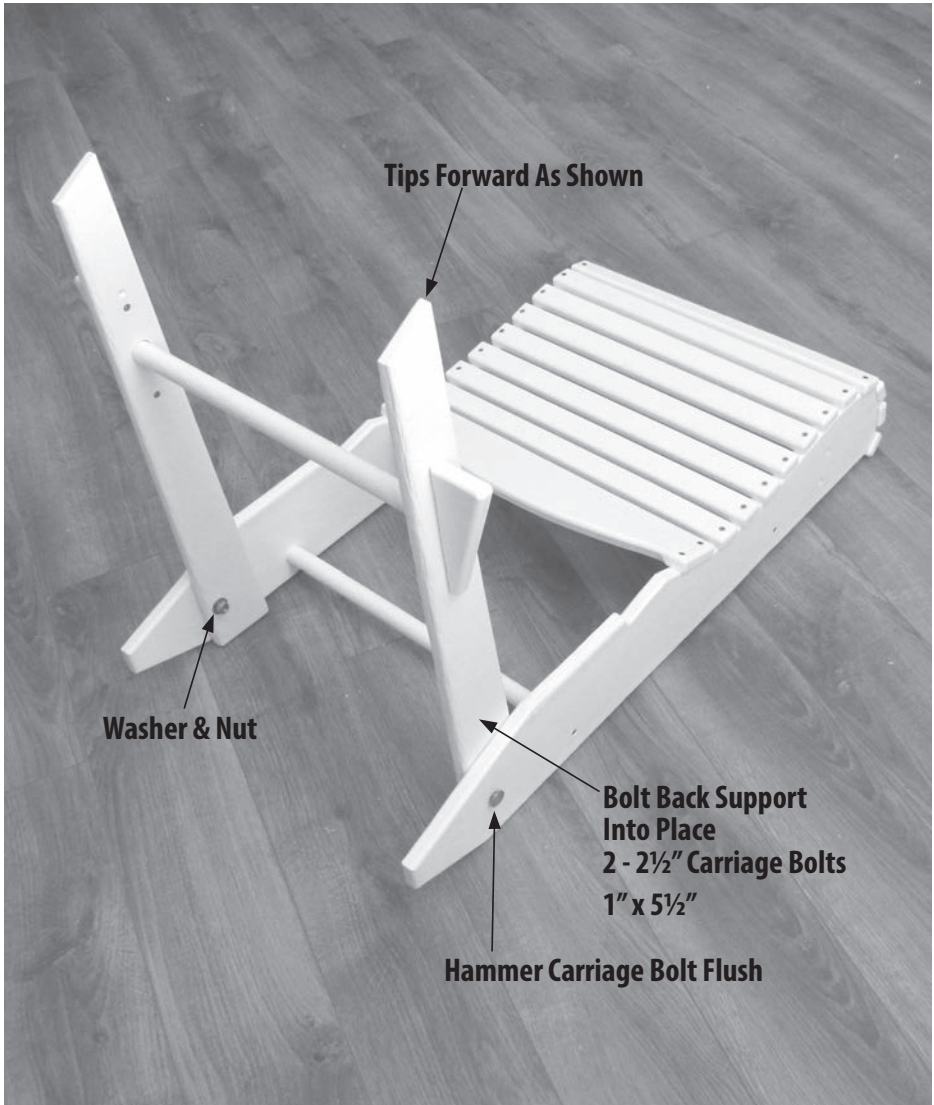

Part D - Arm and Front Leg Assembly, 8 parts



Part D - Arm and Front Leg Assembly, 8 parts



Part D - Arm and Front Leg Assembly, 8 parts

1" x 5½" Muskoka Chair



Part E - Front Plate Install, 1 part

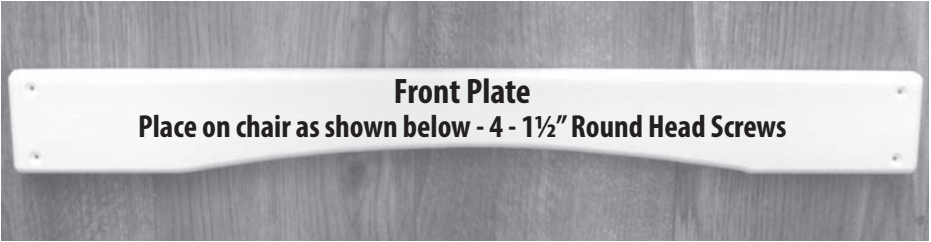



**Tighten
all nuts
with 9/16"
socket or
wrench**

**Use hammer to recess carriage
bolt ready for tightening**



Congratulations!

Your Muskoka Chair assembly has successfully been completed.

Thank you for your patronage

Send us your email to
muskokachair@outlook.com
for periodic promotions

Accessories Available

- Foot Stools
- Side Tables
- Coffee Tables
- Chair Cushions
- Head Rests
- Chair Storage Covers



1032 Henshaw Lake Road, Box 494, Port Carling, ON P0B 1J0
muskokachair@outlook.com • 705-706-3836



www.muskokachair.com

