

MODEL SPECIFIC OPERATIONAL MANUAL



BeamBrush 35



BeamBrush 3-10

BEAMBRUSH SERIES

TABLE OF CONTENTS

1. Introduction	3
2. General information	4
2.1 What is a laser and how does it work?	6
2.2 Laser Safety first!	7
2.3 Installation of the System	8
2.4 Control System	9
2.5 Scanning System	10
2.6 Connection Diagram	12
2.7 Multiple System Interlock	13
2.8 Switching ON sequence and User Interlock	14
2.9 Maintenance	16
3. BeamBrush	17
4. Item Checklist	21
5. Optional Accessories	22
6. System Overview	23
6.1 Front View	24
6.2 Side View	25
6.3 Rear View	26
7. Beam Alignment	28
7.1 Beam Alignment [BeamBrush 3000]	29
7.2 Beam Alignment [BeamBrush 6800]	30
7.3 Beam Alignment [BeamBrush 10]	32
7.4 Beam Alignment [BeamBrush 35]	34
7.5 Beam Alignment with Motorised Dichroid Filters	36
8. Colour Balance display mode	37
8. Technical Specifications	38
8.1 Technical Specification [BeamBrush 3000]	39
8.2 Technical Specification [BeamBrush 6800]	40
8.3 Technical Specification [BeamBrush 10]	41
8.4 Technical Specification [BeamBrush 35]	42
9. Troubleshooting	43
10. Contact Information	48

INTRODUCTION

Thank you for purchasing this KVANT and Pangolin product.

To ensure proper operation, please read this manual carefully before using the product.
After reading it, keep it in a safe place for future reference.

GENERAL INFORMATION



The following chapters explain important information about lasers in general, basic laser safety and some tips about how to use this device correctly.

Please spend some time reading these information as some of them are critical for safe and efficient operation of this laser display system.

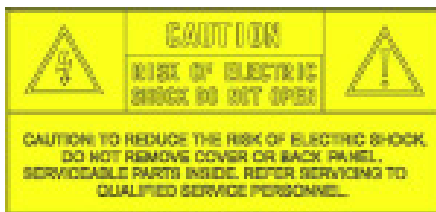

user manual

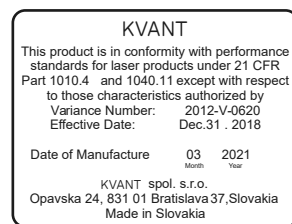

Max current at 110V: 3A
Max current at 230V: 3A

Caution



This laser entertainment system is rated as a **Class IV laser product** and manufactured in accordance to **EN 60825-1:2014**. Avoid eye or skin exposure to direct or scattered radiation. Wear protective goggles of suitable optical density if necessary.



If the laser is operated in a situation where health or property injury may occur the operation must be stopped immediately.



The manufacturer and its distributors cannot be held responsible for any damages caused by improper use or misuse of this KVANT laser system. The owner/user is fully responsible for using this product in accordance to laser safety regulations of the country or state where the system is being used.

Please note that some other optical devices such as cameras, camcorders, video projector etc. can be damaged if exposed to excessive laser radiation.

Handling precautions

This laser system is a precision device that contains some sensitive opto-electronics components. DO NOT drop it or subject it to physical shock.

This laser system is not waterproof or dust-proof. Make sure to use an appropriate cover or enclosure if it is used in the rain, snow or similar severe environment conditions.

Do not leave the laser system in excessive heat such as in a car whilst in direct sunlight. High temperatures could cause some serious damage to the system.

The laser system contains precision electronic circuitry. Never attempt to disassemble the laser yourself.

If the laser is suddenly brought in from the cold into a warm room, condensation may form on the laser and internal parts.

If condensation forms on the laser body, do not use the laser as this may damage the laser system. If there is condensation, wait until it has evaporated before using it.

WHAT IS A LASER AND HOW DOES IT WORK?

What is a LASER?

The laser is a device that creates continuous visible light energy waves (streams of photons that are referred to as “laser radiation”) with the same amplitude and phase that are flowing in the same direction; meaning they are coherent – they stick together and form a laser beam.

The width of a single wave is measured in nano-meters and defines the colour and visibility of the laser beam. The visible spectrum of the human eye is roughly between 400nm and 700nm, going from violet to a dark red colour. A human eye is most sensitive to a green light of around 555nm, meaning that a 1W of green laser will always appear more visible than 1W of any other colour laser. 1W of quality laser light is very powerful and although it doesn't sound like much it can burn eye retinas, skin and clothes or even start a fire!

What makes the laser visible in mid-air?

Mainly it is the particles of dust in the air that the laser beam hits on its path, scattering the light. This dust or fog is called a “scattering medium”. That's why we “laserists” use haze or smoke machines to make lasers more visible. Too much of the haze or smoke will greatly attenuate the visibility, but the right amount will make all the difference between no show and a great show.

When outdoors, lasers mainly reflect off dust and mist in the air but due to unpredictable wind conditions we can never make sure the hazers or smoke machines will be effective enough. And that's why we use high power lasers for outdoor shows – to substitute for the lack of dust, haze and smoke.

Colours

Standard full colour analogue lasers use three primary colours: Red, Green and Blue. By mixing those together you can pretty much get any secondary colour:

Red + Blue = Magenta
Red + Green = Yellow
Green + Blue = Cyan
Red + Green + Blue = White

Of course the number and precision of the colours is determined by the modulation, stability and linearity of the system. If the system is not stable enough, it will produce different colours every time it is used, making it virtually impossible to match the colours of two systems at any one time. This is very often the case with systems from far east manufacturers and with re-branded lasers that are being presented as European makes.

How far does it travel?

Technically, the laser light will travel forever until it strikes a surface and is absorbed. A better question is – how far will the light travel and still be useful? Depending on the power output of the system and weather conditions, the laser can be visible for miles – that is why we need to be cautious about aircrafts when performing outdoor shows. And if you get a system that is powerful enough then yes, it can reach the Moon.

Scanning System

A scanning system is essentially two tiny mirrors, each moving on X or Y axis. By working together they can “scan” the laser beam over a wide angle in front of the projector. The scanning system can not only direct the laser beam to specific, static locations, but it can also create shapes by rapidly moving the laser beam over a path. Once a shape is scanned more than 20 times per second, it appears static to the human eye. So any shape drawn by a laser is actually produced by one single laser beam being moved by these mirrors very quickly. Every scanning system has a mechanical limit of how fast it can move its mirrors and therefore how many points it can display at any one second and that is usually represented in Points Per Second at a certain scanning angle, i.e. 8 degrees.

LASER SAFETY FIRST!



Before proceeding any further, please read the following safety page very carefully. It could help you avoid dangerous and hazardous situations which could lead to serious injury or property damage.



Any laser system classified as a Class 4 laser must be used with caution. If you are an inexperienced laser operator, we strongly recommend that you attend a laser display safety course before you use this laser system in public areas. There are various places in Europe where you can attend quality training and even a one day course will give you a good amount of valuable information to safely start with.

Unless you are very competent with the use of lasers and about the laser safety, make sure you at least follow these basic laser safety rules:

1. Never look directly into a laser beam
2. Never look directly into laser aperture if the laser system is switched on .
3. Be aware that lasers can burn the eye retina, skin or cause fires if not used correctly.
4. Audience Scanning is a technique that involves projecting laser effects directly into an audience. Never perform Audience Scanning unless you: a) are trained to do Audience Scanning; b) use a projector that has the proper safety systems built in (such as PASS); and c) have verified that the projected light levels do not exceed the applicable MPE for the jurisdiction. Otherwise, always project with the laser above audience head level – at least 3m above floor level.
5. When projecting the laser outdoors, avoid pointing the laser at aircrafts, buses, trains, etc. Never leave the laser system unattended when it 's switched on.
6. Always check for reflective surfaces within the laser range – these can be very dangerous (i.e. mirror behind the bar in a club could bounce the beam into bar attendant's eye).
7. Never hesitate to use the Emergency STOP if you think there's a fault within the laser system or a potential danger to a person/object caused by the laser performance.

INSTALLATION OF THE SYSTEM

Please follow these rules during the installation:

1. Do not connect the device to power supply during the installation. Only connect the device to power after the installation and mounting have been completed.
2. Mount the system only to mounting point that is strong, secure and away from places where nonauthorised person could get an access to.
3. Always make sure the system is properly tightened down, and that it cannot get loose and move as a result of sound vibrations, cables pulled on, or similar external disturbances.
4. Always attach a safety chain or cable between the projector and its structure (such as truss).
5. Ensure that all the cables have enough length just incase they get caught.
6. Ensure that the system is placed at least 20cm away from walls or any other objects including drapes etc.
7. Ensure that the system is placed well away from any heat sources including spotlights, moving heads, radiators, etc. Make sure there is a sufficient air-flow around the laser system.
8. It is essential that the fan openings are never covered during the laser operation.
9. Always follow the Laser Safety Regulations of respective country where the laser is being used.



The manufacturer is not liable for damages or a injury caused by improper installation of the system. The installation should be carried by a qualified installer who should follow the Laser Safety Regulations of respective country.

2.4

CONTROL SYSTEM

The overall performance of any KVANT laser system is also dependent on the control system that you use for operating the laser as well as the correct device configuration in the laser control software.

Please make sure all the laser settings in your control system are set correctly before you start using your Kvant laser display system.

2.5 SCANNING SYSTEM

The product warranty does not cover the damages to the scanning system caused by improper use of the scanning system or by incorrect programming. Therefore it is essential to understand how the scanning works and where are the limits of it. In this manual we will explain only the basics of it but it is the responsibility of every user to educate themselves so they can avoid damage being caused to the scanning system and costly repairs.

A laser beam comes from a laser module and hits the two moving mirrors of the scanning system. These mirrors are mounted on the scanner shafts and are moved by the scanner rotors, one on X and one on Y axis.



An effect such as tunnel (circle) is displayed by a repetitive mechanical movement of the scanners. For each scanning system and effect, there's a maximal scan-rate that is defined by mechanical load, scanner mirror size and weight, complexity of displayed picture and size of the projection (an angle under the laser beam is being projected). A different scanning systems have different scan-rate limits. It is essential to operate the scanning system at scan-rates within its maximal limit at all times to prevent it from overload damage.

How to establish correct Scan-rate and maximal number of points in an effect

Each effect (picture) contains a different number of graphical points which defines the actual shape of the effect. The more points an effect contains, the lower the maximum scan rate will be in relation to the scanning angle.

As an example we'll work with the star effect shown below and with the parameters of quality scanning system:

Let's say the star effect is made of 300 graphical points (including non-visible blanking points) and we know that the maximal scan-rate of our scanning system is "35K". (The term "35K" refers to a metric that is achieved when the original ILDA test pattern is projected at 8 degrees, and all of its visual qualities are maintained. Note that all other patterns may be scanned much wider, and in some cases even faster, but the term "35K" only refers to a single test pattern, and single test condition). We also know that we display the star 35 times per second which is a default frame rate of the control software we are using.

So we need to display 300 points 35 times per second = 10.500 pps. This means that we could display 3 of these stars beside each other within one single laser effect and that it would be quite close to the scanner limit ($3 \times 10.500 = 31.500\text{pps}$). Given that the scanners noted above are "35K" scanners, this seems easily achievable. However, the projection of 3 separate stars necessitates a wider scan angle, and – in general, the scan speed must be reduced as the projection angle is increased. Thus, it may be necessary to either lower the number of points within the effect or drop down the scan-rate in the control software (FPS) to a safe level – which may result in flicker.

In the following pictures you see the same star effect scanned at different scan rates at full scanning angle (60 degrees).

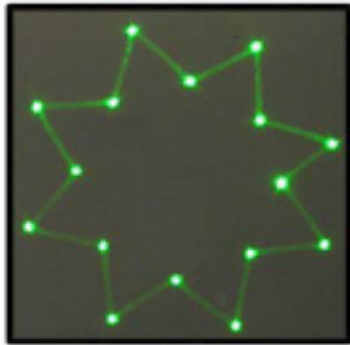

picture 1

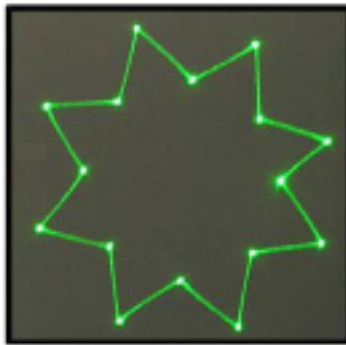

picture 2

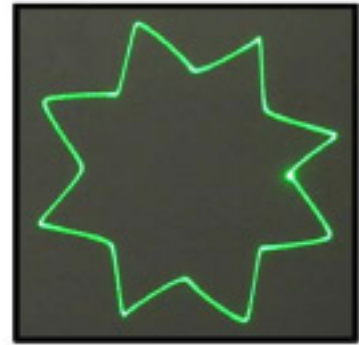

picture 3

Picture 1: the scan rate and/or number of points is too low. The corner points are more visible than the lines between them and the whole effect flickers. The scan-rate and/or number of points needs to be increased.

Picture 2: the scan-rate and/or number of points is about right. The whole effect has more or less the same intensity and does not flicker.

Picture 3: further increasing of the scan-rate and/or number of points results in the effect starting to distort, firstly around corners only. This indicates that you are exceeding the maximal scan rate of the scanning system! If you operate the scanning system at scan-rates higher than the maximum scan-rate of the scanning system the scanners will get damaged irreversibly due to overheated coils damaging rotor magnets.

2.6 CONNECTION DIAGRAM

Please check that all the signal and power leads are correctly installed and that the safety keys are inserted in all necessary positions.

i Both E-STOP Remote safety key and laser system safety key must be inserted and switched to ON position in order to disable the interlock.

! USA ONLY: Remote Interlock Bypass must be inserted in the E-STOP Remote as well in order to disable the interlock.

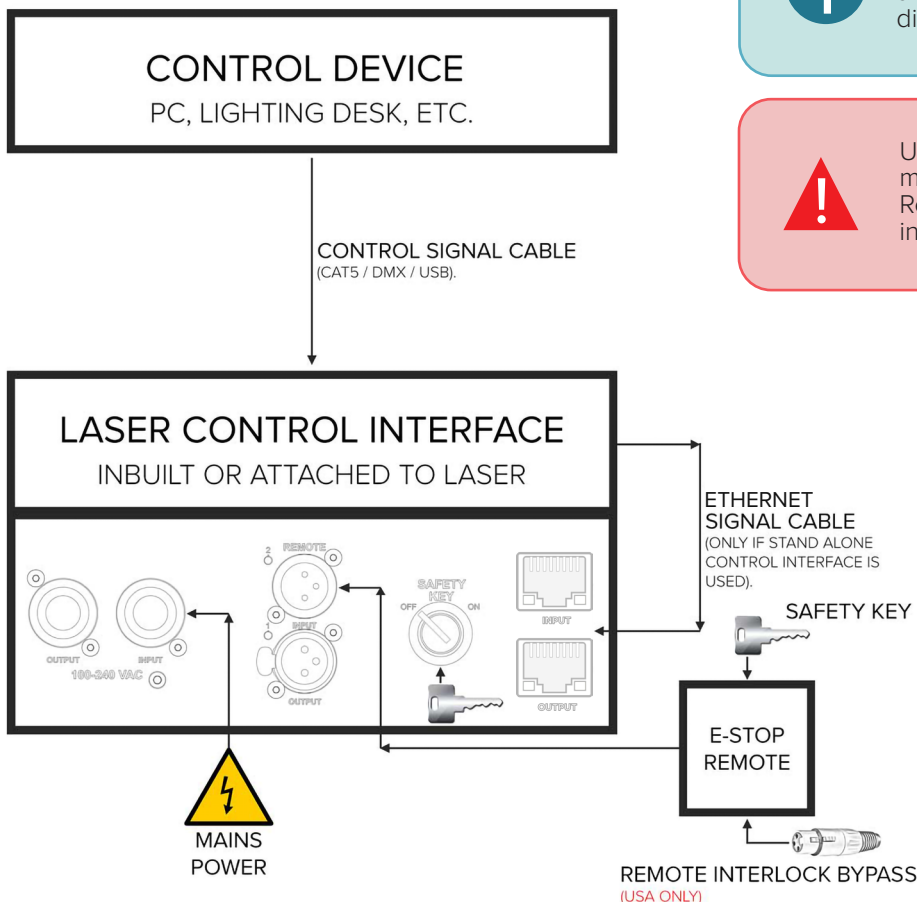

MULTIPLE SYSTEM INTERLOCK

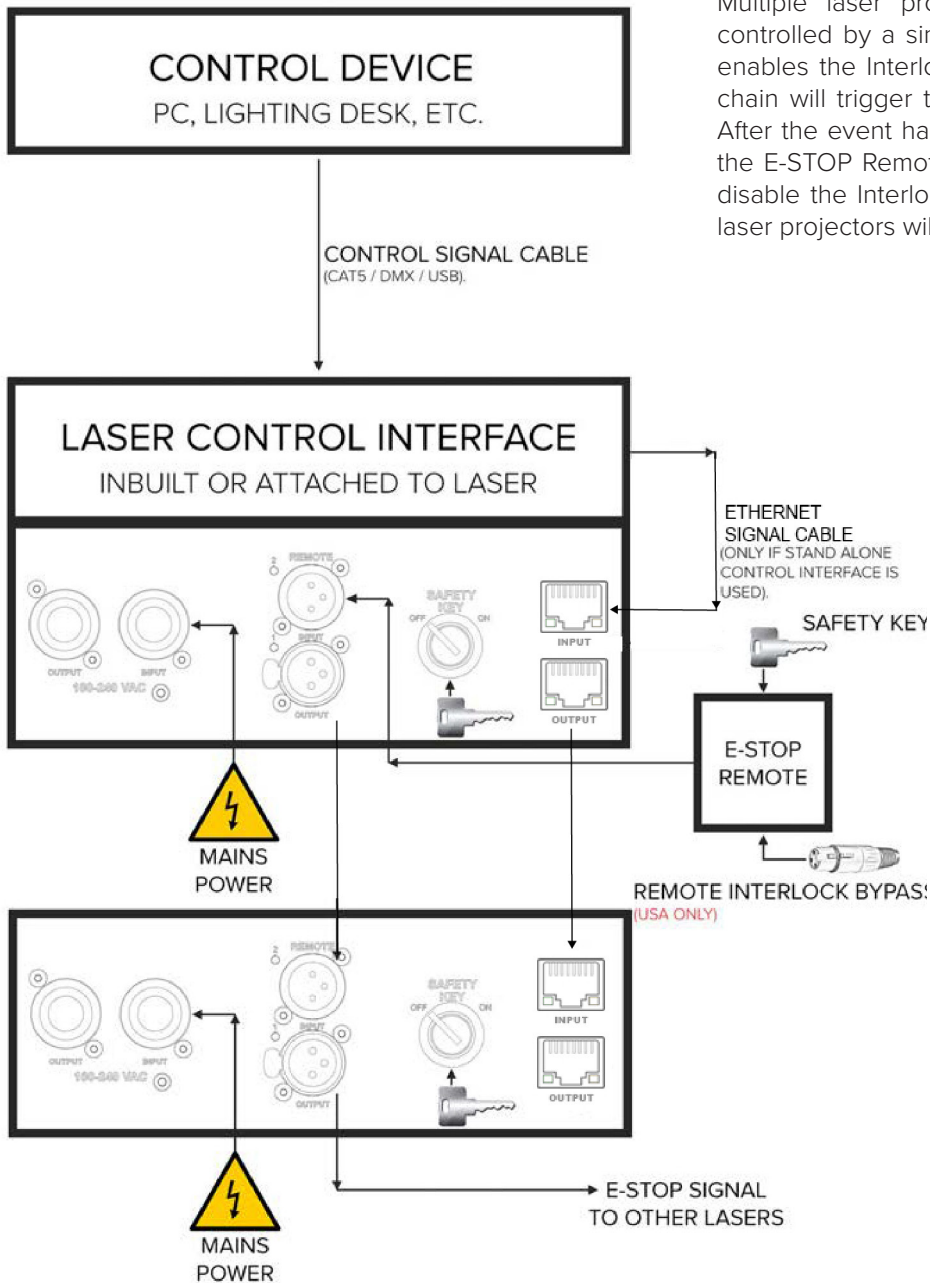

Multiple laser projectors may be daisy chained and controlled by a single E-STOP Remote. Any event which enables the Interlock on any laser projector in the daisy chain will trigger the safety Interlock for all the systems. After the event has been corrected the START button on the E-STOP Remote must be pressed by the operator to disable the Interlock. After an Emission Delay period the laser projectors will be ready for use.

SWITCHING ON SEQUENCE AND USER INTERLOCK



Please make sure that all laser display safety requirements are fulfilled in accordance with laws of the country where this KVANT laser system is being used before switching the system ON.

1. Connect the system as showed on Connection Diagram.
2. Turn both E-STOP Remote and laser system safety keys to ON position.
3. Release the E-STOP button by pulling it upwards.
4. Open the aperture window by loosening the bolt at the bottom of the aperture, adjust the masking plate to desired position and tighten the bolt to secure it.
5. Press the START button on the E-STOP Remote.
6. After an Emission Delay Period the laser projector will be ready for use.

Interlock Connection Diagram

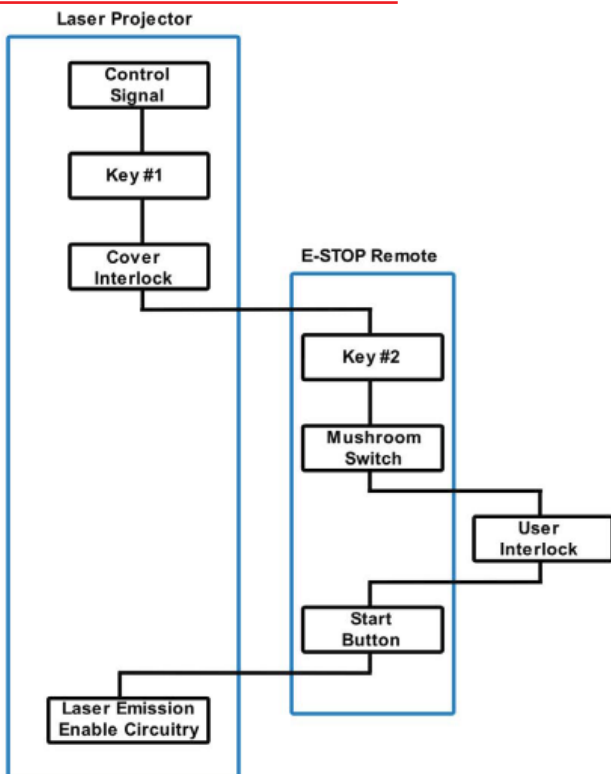

Interlock Enabled, Laser Output Terminated

The Interlock is latched enabled and the laser projector's beam output will be terminated if any of the following events happen:

1. Power loss lasting greater than 2 seconds.
2. Mushroom emergency switch depressed.
3. #2 Key Switch on E-STOP Remote turned to OFF position.
4. #1 Key Switch on laser projector turned to OFF position.
5. Any other interruption to line No.1 of the cable leading to the E-STOP Remote. This includes any user interlocks connected in series in the line No.1 of this cable. Refer to Connection Drawing below.

Restarting Laser After Interlock or Power Failure Event

After the event has been corrected the START button on the E-STOP Remote must be pressed by the operator to disable the Interlock and after an Emission Delay period the laser projector will be ready for use.

E-STOP Connection Drawing including User Interlock option

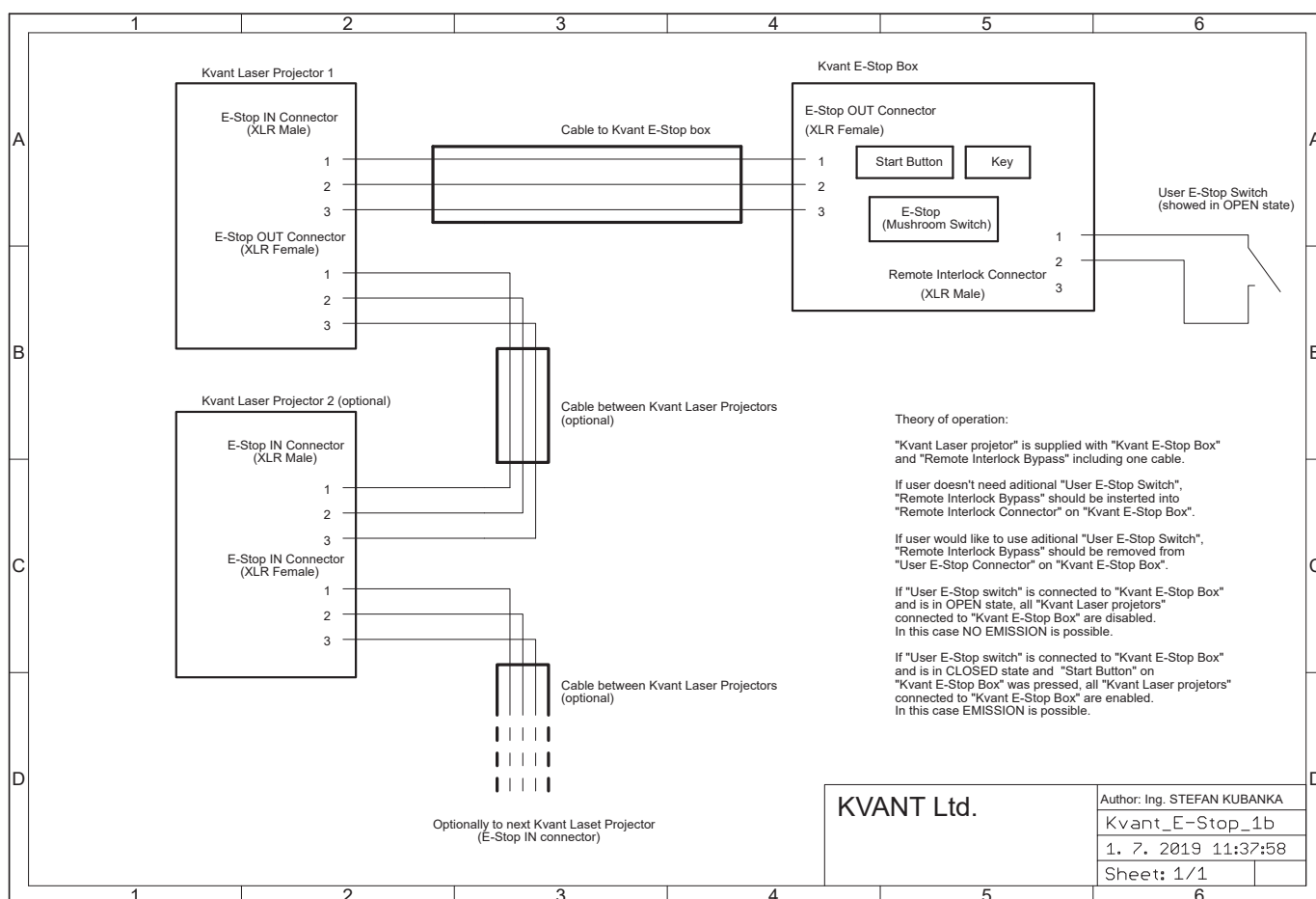

The E-STOP Remote is an integral part of the laser projector. It is there for the safety of the public as well as the operator. Modifying or using anything other than the E-STOP Remote provided, in the manner it was intended, may invalidate your laser projector's variance.

MAINTENANCE

Maintenance: no user serviceable parts inside.

Aperture Window

To clean the aperture output window use a soft cloth and medical grade isopropyl alcohol. If necessary, you can remove the aperture output window by loosening the 4 socket bolts and clean the inside of the window as well.

Cooling Fans

Use compressed air for cleaning the bottom part of the laser system. There are cooling fans located at the bottom of the heat sink and they are vital for correct operation of the laser system. Please always ensure that they are spinning freely.

You should perform this service every 2 months if the laser is used regularly or even more often if it is used in dusty conditions.

Internal Optics

The cleaning of the internal optical components should be performed by an authorised technician only. Incorrect techniques or wrong choice of chemicals used for cleaning could cause serious damage to the laser system. Due to the fact that the optical compartment is split and sealed from the rest of the laser system it shouldn't be necessary to perform this procedure more often than once a year.

Drying agent cartridge

Drying agent cartridge (silica gel desiccant) helps to prevent water condensation inside the optical compartment of the laser system, which is much needed in high temperatures and high humidity environments. The desiccant cartridge is installed on the inside of the optical compartment cover.



It is essential to regularly inspect the condition of the silica gel granules inside the cartridges. That can be done through the opening in the middle of the cartridge. If the colour of the granules inside the cartridge is green, instead of brown (brown is when they are dry), it means they are soaked, and they must be dried out. Inspect the cartridge every time you open the optical compartment, or at least once a month.

The drying out process is pretty simple:

1. Detach the cartridge from the cover and place it into the conventional oven - do not use microwave!!!
2. Heat the oven to 120°C (250°F) and leave the cartridge inside for about 2-3 hours, until all the moisture is released.
3. Insert the cartridge back into its place and close the optical compartment cover as soon as the cartridge cools down. That way, it will absorb the maximum amount of moisture from the inside of the optical section.



If the granules don't turn brown during this process, they must be replaced with new ones.

BEAMBRUSH

The following is a discussion of the BeamBrush system built-into Kvant BeamBrush projectors. The BeamBrush concept has been developed over a period of more than 30 years, and BeamBrush implementations have gone through five separate generations. Pangolin's BeamBrush implementations are collectively covered by six separate patents: US 9,244,273; CN 201420101575.8; DE 20 2014 002 094.9; US 8,254,045; US 6,580,560; and US 5,621,561.

All BeamBrush implementations are based on the same principal: Creating a Keplerian telescope, and performing the equivalent of moving one lens toward the other. This principal is shown below.

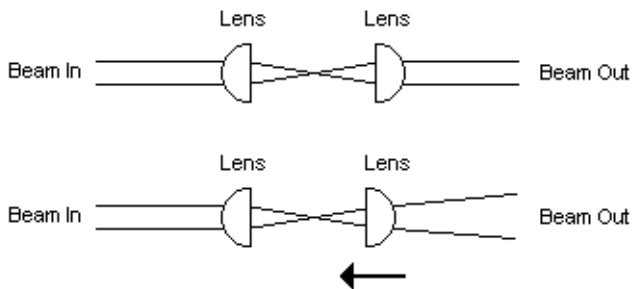

As you can see in the illustration above, moving one lens toward the other will result in adjustment of the divergence of the output beam. The principle is simple, and moving one lens may intuitively seem easy, but it is not. Since light has to pass through the center of both lenses and also potentially through the lens actuator, this makes direct actuation difficult. Moreover, laser light show projection involves virtually instant changes of the beam diameter, and finding a fast and accurate actuator that can accomplish this has been elusive.

For decades, variable focus has been done in 3D laser marking systems. This involves the linear motion of a lens and carrier that rolls on bearings, and connecting that to the shaft of a scanner via Rolamite system. However, while this is sufficient for laser marking, this will not work for laser light shows, since the entire system is heavy and full of undesirable resonances, which prevents high speed use.

Pangolin recently started manufacturing the ScannerMAX Saturn 9, which is a galvanometer scanner that may also be used as a rotary actuator. The Saturn 9 is capable of performing extremely fast moves, and sustaining those moves at rates of more than 1000 times per second. The Saturn 9 also incorporates a high-accuracy position sensor, and thus, it provides a great platform for BeamBrush.

Since the Saturn 9 is a rotary actuator and not a linear actuator, the Keplerian telescope described above must be modified, to incorporate a retro-reflector as shown below. If the retro-reflector is moved linearly, this is effectively equivalent to moving the lenses closer and further away from each other. By placing a retro-reflector at a strategic rotation point, and by rotating the entire retro-reflector, you can create the same kind of path length change as with linear motion of the retro-reflector. The retro-reflector is pivoted by the Saturn 9, and the pivoted retro-reflector takes on the shape of a boomerang. Because of its shape, we refer to the pivoting retroreflector as a "boomerang".

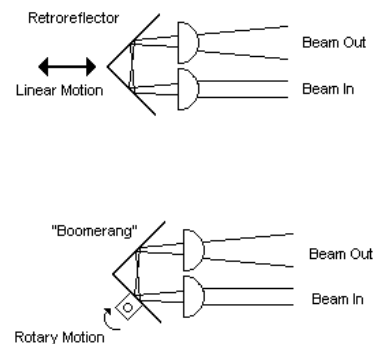

Because the beam path is now U-shaped, the beam path must also be modified a bit, in order to be used with X-Y scanners. Fortunately, this modification results in a very convenient and compact X-Y-BeamBrush scanning package.

Typical scanning system without Beam Brush

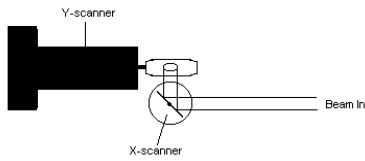

Scanning System With Beam Brush

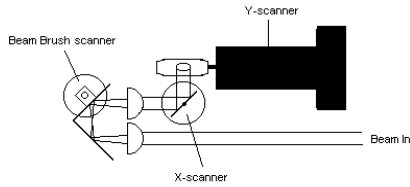

The lens distance and boomerang angular excursion are adjusted so that the beam is only capable of increasing divergence, and not capable of decreasing divergence. This ensures that, when used along with audience scanning, the irradiance always decreases (i.e. safety always increases) as distance between the projector and the audience increases.

BeamBrush projectors are typically delivered to allow a dynamic divergence ranging from less than 1 milliradian to 30 milliradians. This is sufficient to allow a great degree of artistic expression, both for graphic and beam effect applications.

Using the Saturn 9, BeamBrush is able to execute small divergence changes in less than 500 microseconds, and execute full 30-milliradian divergence changes in 1 millisecond. This system is capable of delivering up to 2000 15-milliradian beam divergence changes, and up to 1000 30-milliradian beam divergence changes per second.

The Saturn 9 incorporates a position sensor, which can be used to verify that the Beam Divergence is above a threshold, when used for Audience Scanning purposes.



In the projector Top View shown above, you can see that the beams emerge from each of the red, green, and blue lasers, and are combined in the standard fashion using dichroic filters. The beam then progresses forward toward the front of the projector, and is reflected 90-degrees by a mirror. The beam then goes through a shutter, before being sent along to the X-Y-Beam Brush scanning system, which is best viewed and fully described in the picture that shows the Front View.

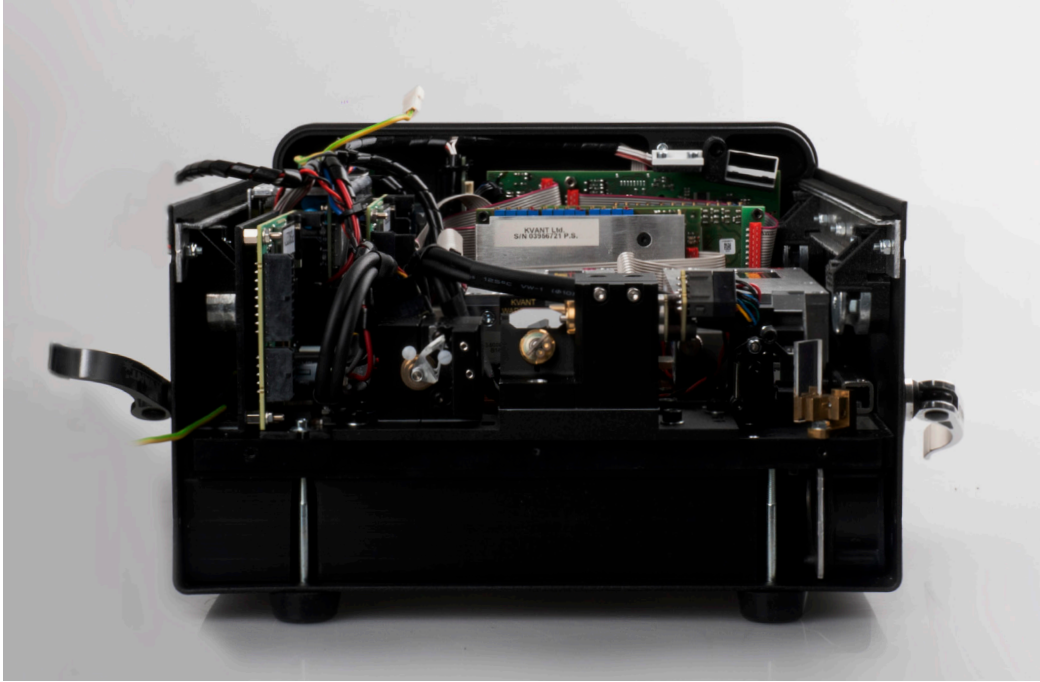







In the projector Front View shown above, you can see how the beam propagates from the combined red, green, and blue lasers described in the Top View.

The beam travels just under the Y-axis scanner, and also below the X-axis scanner mirror, toward a first BeamBrush Lens. The beam then goes through that lens, toward the Boomerang, which is rotated (actuated) by the BeamBrush Scanner. The boomerang is a retro-reflector, which directs the beam through a second BeamBrush Lens, then onto the X-axis scanner mirror, onto the Y-axis scanner mirror, and finally through the exit aperture at the front of the projector.

ITEM CHECKLIST

Before starting, check that all the following items have been included with your laser system. If anything is missing, contact your supplier.

Item	Quantity	Descriptions	Item	Quantity	Descriptions
	1x	KVANT BeamBrush Laser Display System		2x	Set of Safety Keys
	1x	Emergency STOP remote		1x	Network Signal Cable (cat5)
	1x	3-pin XLR Emergency Stop Remote Cable		1x	User manual USB drive
	1x	Remote Interlock Bypass (for USA only)		1x	Heavy duty flight case
	2x	AC Power cable with powerCon TRUE1 connector			

5 OPTIONAL ACCESSORIES

Here is a list of optional accessories that are compatible with BeamBrush laser system.

Item	Description
	SafetyScan lens attachment bracket (lens is not included). This item is compatible only with this model version.
	DiscoScan lens attachment bracket (lens is not included). This item is compatible only with this model version.
	4-way masking plate
	Rain cover
	MicroWheel grating set

Item	Description
	Motorised Dichroid Filters for Easy Colour Alignment
	Pass (Professional Audience Safety System) Card Integration
	Monsoon Box with Air Conditioning
	Beyond upgrade



SYSTEM OVERVIEW

KVANT BeamBrush is a full colour, semiconductor diode laser system designed for professional laser displays.

When operated correctly and in the right conditions the BeamBrush laser system is able to deliver a strong performance in venues with up to 6000 people. The BeamBrush can display virtually any colour within the basic RGB palette and its secondary mixed colours including white.

The system is air-cooled and designed so that there is no airflow going through the optical compartment of the system. This ensures that all important optical parts of the system stay clean for longer, keeping the maintenance time down to a minimum. This is a real advantage for all the venues where lots of smoke or haze is used on a daily basis.

The laser projector is neither waterproof, nor completely dustproof. Please use it indoors and avoid places with excessive amounts of dust.

G4

FRONT VIEW



1. Laser aperture. To clean the laser aperture window from inside or to swap the aperture plate for different type of aperture (i.e. DiscoScan lens attachment bracket), remove the four socket bolts that hold the laser aperture in place and remove it .

4. Laser emission indicator. When this indicator is lit up the laser system is ready to emit the laser radiation as soon as it receives instructions from control software.

2. Aperture masking plate. This metal masking plate can be moved up and down when the locking bolt is loosened. This useful safety feature gives you an option to limit the bottom of the laser output area if necessary (for example to avoid audience scanning) and also protects the aperture glass during transport.

5. Optical compartment cover bolts. To access the optical compartment of the laser system undo 8 button hex bolts and carefully remove the cover.

3. Attachment bracket. The attachment bracket spins 360 degrees around the laser body whilst it can be locked in desired position by two small locking handles on sides. Due to the sophisticated locking mechanism there's no need to use excessive force when locking the system in position.

6. MicroWheel grating assembly port (optional accessories). To open press the bottom of the cover.

C.2

SIDE VIEW



1. RGB colour alignment mechanism. To access the colour alignment mechanism rotate counterclockwise the 4 silver bolts and remove the cover.

Size of the chassis on the picture above can vary, depending on exact BeamBrush model.

REAR VIEW



1. Mains power INPUT/OUTPUT. Use supplied Neutrik powerCON TRUE1 power cable to connect the laser system to mains power supply using the INPUT connector. The OUTPUT connector is used to daisy chain power between multiple laser systems for quick and easy installation. **The powerCON TRUE1** is a connector with breaking capacity (CBC), i.e. it can be connected or disconnected under load or live.

The Remote Interlock Bypass may be replaced by the user's own interlock system using a switch or dry relay closure to connect pins 1 and 2. With pins 1 and 2 shorted, Laser Emission is possible, provided all other interlocks are closed circuit. With pins 1 and 2 open, NO Laser Emission is possible.

The Interlock status indicator START (3) goes off and status indicator READY (3) lights up when the Interlock is closed circuit and the Interlock key is in the ON position. All above must be done correctly to allow laser emission from the system.

2. E-STOP Remote connector, Interlock status indicator and User Interlock. In order to use the laser system, the Interlock must be closed circuit. This is done by connecting the Emergency STOP Remote to the XLR REMOTE INPUT socket on the projector using the supplied cable. The US version of the Emergency STOP must also have the Remote Interlock Bypass inserted into it .

 The E-STOP Remote is an integral part of the laser projector. It is there for the safety of the public as well as the operator. In most countries it is required by law to have a fully working Emergency STOP in place for every laser system used. Modifying or using anything other than the E-STOP Remote provided, in the manner it was intended, may invalidate your laser projector's variance.

The projector's REMOTE Output is used to daisy-chain the Remote signal when you want to use a single Emergency STOP Remote to control multiple systems.

After a power failure or interlock failure (open circuit) has occurred and been corrected you need to manually reset laser emission by pressing the START button on the E-STOP Remote. Laser emission will then be available after a 60 second delay.

3. Safety key switch. The Safety key must be inserted and turned to ON position in order to enable the system to operate.

4. Ethernet. Use these ports to connect PC control signal or to daisy chain the control signal between multiple laser display systems.

5. DMX Input/Through. Use these ports to connect DMX control signal or to daisy chain the DMX signal between multiple laser display systems.

6. ILDA INPUT. Use this input connector for the control signal input from your external control interface when not using the inbuilt FB4 interface.

7. FB4 laser control interface. The inbuilt control interface allows you to control the laser via Ethernet and DMX/ArtNet, but it also handles all the basic settings of the laser system (master size and positions, method of control, colour settings etc.). All of these settings can be accessed through the menu using the endless rotary knob and once saved, they are stored on included mini SD card.

8. Colour Balance display mode switch. When the Colour Balance display mode is active, all the colours displayed by laser will match those you see on the screen in your laser software (they can vary slightly, depending on your display and its colour settings). The on & off setting of Colour Balance mode is immediately stored in the internal memory of the laser projector, so next time you power it up, the Colour Balance mode is set to its latest state automatically.

The intent of laser manufactures is to produce a laser diode driver with as linear response behaviour as possible, so when the diode current increases, the optical power and light intensity grow linearly. However, the human eye senses brightness of light logarithmically over a moderate range (Weber–Fechner law). So when light intensity grows linearly, human eye and brain doesn't perceive it as a linear increase, and our visual perception of colours changes.

In the world of laser display systems this generates challenges when we work with mixed colours (i.e. yellow, magenta etc.). Normally the mixed colours coming out of laser systems do not directly correspond with those we see on computer screens – because of the difference in visual perception. In order to synchronise all the colours we see on our screen and those coming out of the laser device we do, so called, palette calibration procedure in the laser control software. This can be of course rather lengthy process and even if it's done properly, the calibrated palette will always be tied to particular control system or profile that was used during the colour calibration and not to the laser projector itself. So we came with the idea to hard-code the "calibrated palette" into every BeamBrush laser system in our factory during the manufacture. No matter what control interface you use or what control signal is used (Ethernet, DMX, ILDA), the calibrated palette is always there, ready for you to be switched on by Colour Balance button.

9. Safety eyelet. Use this together with appropriate safety wire to secure the system against unexpected fall.



7 BEAM ALIGNMENT

Electrostatic discharge (ESD)

The laser diode cans in BeamBrush systems are electrically connected with the laser module housing that encloses them. It means that ESD can destroy the laser diode(s) if the laser module is touched, even though we use the LASORB protection element per every single laser diode.



Please make sure you are correctly ESD grounded (ideally to the heatsink) before you touch the laser modules.



The riskiest of all is touching the electrical contacts on the small PCB mounted on the side of the laser module housing. Some of the contacts are directly linked to the laser diodes inside the module - aside from LASORB protection!

Note that the LASORB won't protect the diodes in all situations. Due to its response time, it doesn't always eliminate all the ESD current, but in some instances may only limit it to a certain level. Also, it won't protect against Charge Device Model (CDM) ESD, that may occur while using some tools.

It is possible that due to transportation, rigging, moving around or vibrations caused by various elements during a set up or laser performance some of the internal optical parts can move slightly resulting in colour misalignment.

The colour misalignment is when two or more colours (red, green and blue) physically do not overlay each other properly like on the picture below. This makes it impossible to get nicely mixed colours like yellow, cyan, magenta and white (including all their shades). If this occurs it is necessary to carry out the beam alignment procedure.

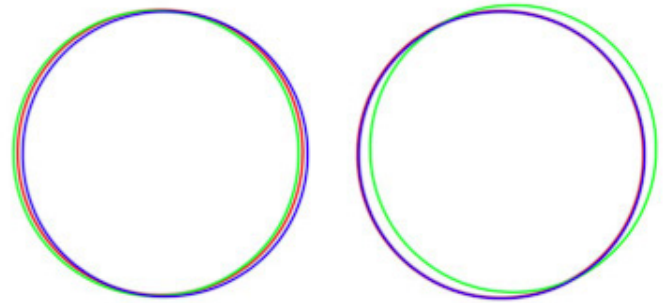

Be cautious when aligning the beams and wear sufficient laser safety protection to avoid accidental exposure to Class 4 laser radiation.

Beam alignment principle

There are three laser modules within this system where each module produces one of the basic RGB colours (red, green or blue).

The goal of the alignment procedure is to align all three beams (colours) so they overlay each other nicely while they hit exact centre of the bottom scanning mirror.

An easiest way to do the alignment is to project a full size circle onto a wall (or any another suitable projection surface), change its colour as necessary and check the alignment of individual colours on both X and Y axes.



Remember that greater is the distance between the laser system and the projection surface during the alignment, more precise the alignment will be.

When doing the alignment on long distances it is always good to have someone with you who can point you in the right direction. Alternatively you can use binoculars.

BEAM ALIGNMENT [BEAMBRUSH 3000]

Although KVANT uses the latest technology to protect all the critical components inside this laser system against Electrostatic Discharge, the semiconductor laser diodes within this system are extremely vulnerable to it. This is due to some of the electronic components being exposed when the top cover is taken off.



If you decide to proceed with the Beam Alignment process yourself, it is absolutely essential that all the common ESD protection rules are strictly followed. We don't accept any responsibility for Electrostatic Discharge damages to laser diodes caused by customer.

How to use the beam alignment mechanism (to align each beam)

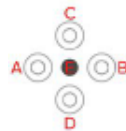

- A + B** | Adjusters for moving the beam UP & DOWN
 - To move the beam UP: loosen screw A and then tighten screw B
 - To move the beam DOWN: loosen screw B and then tighten screw A
- C + D** | Adjusters for moving the beam LEFT & RIGHT
 - To move the beam LEFT: loosen screw C and then tighten screw D
 - To move the beam RIGHT: loosen screw D and then tighten screw C
- E** - fixed position pivoting bolt - DO NOT USE!



All alignment screws A,B,C and D must be fastened at the end of each beam alignment procedure. Even if only one of them is loose, there will be not enough internal pressure on the pivoting bolt (E), which may result into misalignment of respective colour.

1. Create a full size red circle (static tunnel effect) and check whether the red circles of all R4, R3, R2 and R1 overlay each other all the way around the shape. If not, follow the diagram below to adjust the beam path accordingly (step 1& 2 on the diagram).

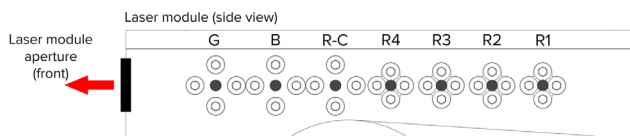

Correct order of the colour (beam) alignment:

- 1) R1 - R4: align four red beams to pairs; R1 with R2 and R3 with R4
- 2) R-C : combine paired beams (R1&R2 with R3&R4) for unified main red beam
- 3) B : align blue beam to red beam for unified magenta beam
- 4) G : align green beam to magenta beam for unified white beam



Please make sure you are correctly ESD grounded (ideally to the heatsink) before you touch the laser modules.

2. Create a full size magenta circle (static tunnel effect) and check whether the blue circle overlays the red circle all the way around the shape. If not, follow the diagram above to adjust the beam path accordingly (step 3 on the diagram above).
3. Create a full size yellow circle (static tunnel effect) and check whether the green circle overlays the red circle all the way around the shape. If not, follow the diagram above to adjust the beam path accordingly (step 4 on the diagram above).
4. Finally create a full size white circle (static tunnel effect). If the alignment procedure was done successfully you can see all the colours nicely overlaying each other, resulting in even, bright and sharp circle like the one on the picture below.

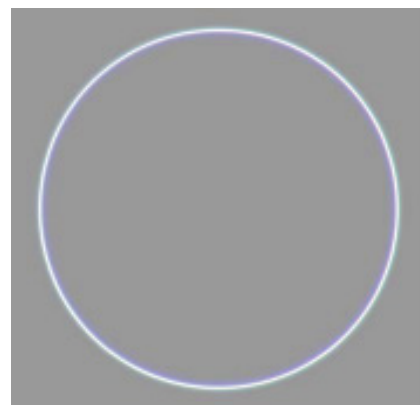

BEAM ALIGNMENT [BEAMBRUSH 6800]



Although KVANT uses the latest technology to protect all the critical components inside this laser system against Electrostatic Discharge, the semiconductor laser diodes within this system are extremely vulnerable to it. This is due to some of the electronic components being exposed when the top cover is taken off.

If you decide to proceed with the Beam Alignment process yourself, it is absolutely essential that all the common ESD protection rules are strictly followed. We don't accept any responsibility for Electrostatic Discharge damages to laser diodes caused by customer.

1. To access the alignment mechanism of **Laser Module 1 (LM1)**, loosen and remove 8 button hex bolts that hold down the top cover.
2. Carefully remove the cover – **detach the GND wire** that is attached to the top cover from the inside of the system! To detach the wire gently pull it out from the connector.
3. Removal of the cover will show the two internal magnetic interlocks. You must flip over the right side of the magnetic interlock until it touches the other side. You will be able to read the warning label “Interlock Defeated”.

4. To access the alignment mechanism of Laser Module 2 (LM2), loosen 2 silver bolts that hold the alignment mechanism cover in place on the side of the unit and remove the cover.
5. Power up the system as normal.
6. Firstly, it is necessary to align the colour with longest beam path between the Laser Module 2 (LM2) output and the scanning system. The beam must hit the exact centre of the bottom scanning mirror and in this case it is the red laser beam (made of 6 individual red beams R6 – R1).
7. Cover the laser aperture of Laser Module 1 (LM1) with a small metal plate of some sort – this will allow you to work with the beams from Laser Module 2 (LM2) only.
8. Create a red beam effect (point) and check visually whether the beam hits the exact centre of the bottom scanning mirror. If not, use dichroic mount DF1 to adjust the beam path accordingly (showed on the picture below). To adjust the dichroic mount use the two adjustment knobs – each one works for one axis.

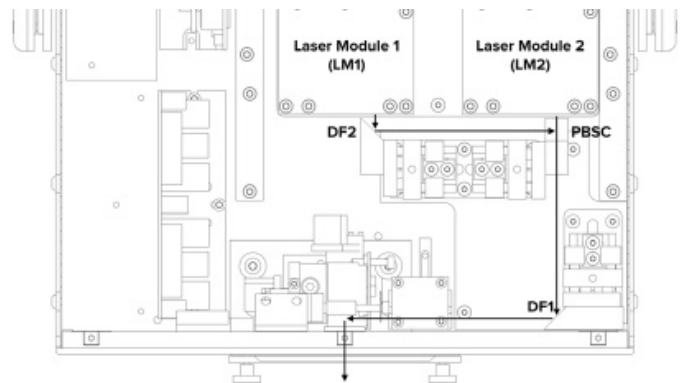

In the defeated position the label “INTERLOCK DEFEATED” becomes visible as shown in the image. Placing the magnetic interlock in the defeated position raises the interlock higher than the edge of the housing which will not allow the cover to be installed.

9. Create a full size red circle (static tunnel effect) and check whether the red circles of all R6, R5, R4, R3, R2 and R1 overlay each other all the way around the shape. If not, follow the diagram below to adjust the beam path accordingly (step 1 on the diagram below).

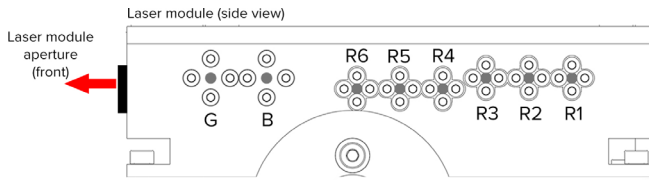

Correct order of the colour (beam) alignment:

- 1) R1 - R6: align six red beams for unified main red beam
- 2) B : align blue beam to red beam for unified magenta beam
- 3) G : align green beam to magenta beam for unified white beam

Always loosen one of the screws in the pair first, before tightening the 2nd one down.

How to use the beam alignment mechanism (to align each beam)

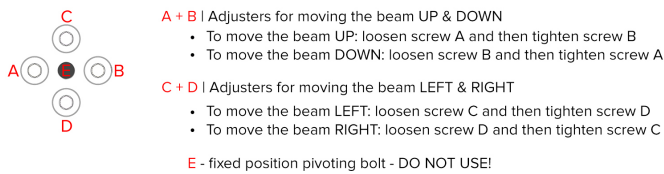

All alignment screws A,B,C and D must be fastened at the end of each beam alignment procedure. Even if only one of them is loose, there will be not enough internal pressure on the pivoting bolt (E), which may result into misalignment of respective colour.

10. Create a full size magenta circle (static tunnel effect) and check whether the blue circle overlays the red circle all the way around the shape. If not, follow the diagram above to adjust the beam path accordingly (step 2 on the diagram above).
11. Create a full size yellow circle (static tunnel effect) and check whether the green circle overlays the red circle all the way around the shape. If not, follow the diagram above to adjust the beam path accordingly (step 3 on the diagram above).
12. Finally create a full size white circle (static tunnel effect). If the alignment procedure was done successfully you can see all the colours nicely overlaying each other, resulting in even, bright and sharp circle like the one on the picture below.

The next step is to align the colours of **Laser Module 1 (LM1)**.

1. Cover the laser aperture of Laser Module 2 (LM2) with a small metal plate of some sort – this will allow you to work with the beams from Laser Module 1 (LM1) only.
2. Create a full size red circle (static tunnel effect) and check whether the red circles of all R6, R5, R4, R3, R2 and R1 overlay each other all the way around the shape. If not, follow the diagram above to adjust the beam path accordingly (step 1 on the diagram above).
3. Create a full size magenta circle (static tunnel effect) and check whether the blue circle overlays the red circle all the way around the shape. If not, follow the diagram above to adjust the beam path accordingly (step 2 on the diagram above).
4. Create a full size yellow circle (static tunnel effect) and check whether the green circle overlays the red circle all the way around the shape. If not, follow the diagram above to adjust the beam path accordingly (step 3 on the diagram above).
5. Finally create a full size white circle (static tunnel effect). If the alignment procedure was done successfully you can see all the colours nicely overlaying each other, resulting in even, bright and sharp circle like the one on the picture below.

Finally we need to align the beams of both **Laser Module 1 (LM1)** and **Laser Module 2 (LM2)** together.

1. Create a full size white circle (static tunnel effect) and check whether the white beam from **LM1** joins the white beam from **LM2** at exactly the same point inside the **Polarisation Beam Splitter Cube (PBSC)**. If not, use dichroic mount DF2 to adjust the beam path accordingly.
2. Once both beams are joined together in **PBSC**, check whether the both white circles overlay each other all the way around the shape.
3. If not, use **PBSC mount** to adjust the beam path of **LM1** accordingly. If the alignment procedure was done successfully you can see both white circles nicely overlaying each other, resulting in even, bright and sharp circle like the one on the picture below.

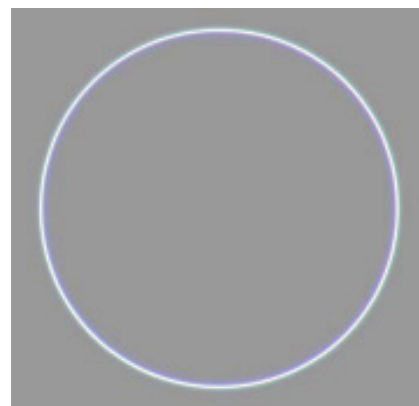

BEAM ALIGNMENT [BEAMBRUSH 10]



Although KVANT uses the latest technology to protect all the critical components inside this laser system against Electrostatic Discharge, the semiconductor laser diodes within this system are extremely vulnerable to it. This is due to some of the electronic components being exposed when the top cover is taken off.

If you decide to proceed with the Beam Alignment process yourself, it is absolutely essential that all the common ESD protection rules are strictly followed. We don't accept any responsibility for Electrostatic Discharge damages to laser diodes caused by customer.

1. To access the alignment mechanism, loosen and remove 8 button hex bolts that hold down the top cover.
2. Carefully remove the cover – **detach the GND wire** that is attached to the top cover from the inside of the system! To detach the wire gently pull it out from the connector.
3. Removal of the cover will show the two internal magnetic interlocks. You must flip over the right side of the magnetic interlock until it touches the other side. You will be able to read the warning label “Interlock Defeated”.



In the defeated position the label “INTERLOCK DEFEATED” becomes visible as shown in the image. Placing the magnetic interlock in the defeated position raises the interlock higher than the edge of the housing which will not allow the cover to be installed.

4. Power up the system as normal.
5. Create Yellow beam effect (point) and check visually whether the Red beam hits the exact centre of the Green beam on the surface of dichroic filter DF3. If not, use dichroic mount DF1 to adjust the beam path accordingly (see diagram below). To adjust the dichroic mount use the two adjustment knobs – each works for one axis.

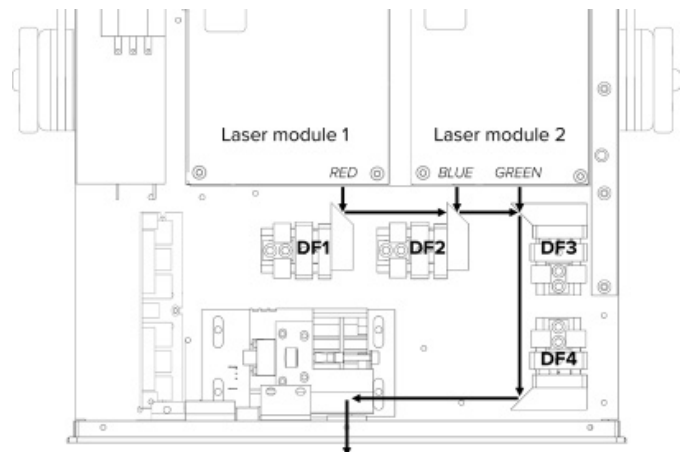

6. Create Cyan beam effect (point) and check visually whether the Blue beam hits the exact centre of the Green beam on the surface of dichroic filter DF3. If not, use dichroic mount DF2 to adjust the beam path accordingly. To adjust the dichroic mount use the two adjustment knobs – each works for one axis.
7. Create Green beam effect (point) and check visually whether the beam hits exact centre of the bottom scanning mirror. If not, use dichroic mount DF4 to adjust the beam path accordingly. To adjust the dichroic mount use the two adjustment knobs – each works for one axis.
8. Create a full size Yellow circle (static tunnel effect) and check whether the Red circle overlays the Green circle in all points around the shape. If not, use dichroic mount DF3 and adjust the beam path accordingly. To adjust the dichroic mount use the two adjustment knobs – each works for one axis.
9. Create a full size Cyan circle (static tunnel effect) and check whether the Blue circle overlays the Green circle in all points around the shape. If not, use dichroic mount DF2 and adjust the beam path accordingly. To adjust the dichroic mount use the two adjustment knobs – each works for one axis.
10. Finally create a full size white circle (static tunnel effect). If the alignment procedure was done successfully you can see all the colours nicely overlaying each other, resulting in even, bright and sharp circle like the one on the picture below.

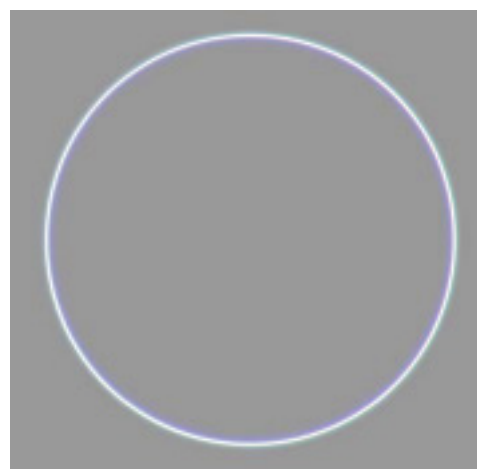

BEAM ALIGNMENT [BEAMBRUSH 35]



Although KVANT uses the latest technology to protect all the critical components inside this laser system against Electrostatic Discharge, the semiconductor laser diodes within this system are extremely vulnerable to it. This is due to some of the electronic components being exposed when the top cover is taken off.

If you decide to proceed with the Beam Alignment process yourself, it is absolutely essential that all the common ESD protection rules are strictly followed. We don't accept any responsibility for Electrostatic Discharge damages to laser diodes caused by customer.

1. Unscrew 14 silver bolts that hold down the top cover – they are spring loaded and will pop-up once loose.
2. Slowly remove the cover – **detach the GND wire** that is attached to the top cover from the inside of the system! To detach the wire gently pull it out from the connector.
3. Removal of the cover will show the two internal defeatable magnetic interlocks. You must flip over the right side of the magnetic interlock until it touches the other side. You will be able to read the warning label “Interlock Defeated”.



In the defeated position the label “INTERLOCK DEFEATED” becomes visible as shown in the image. Placing the magnetic interlock in the defeated position raises the interlock higher than the edge of the housing which will not allow the cover to be installed.

4. Power up the system as normal.
5. Create a red beam effect (point) and check visually whether the red beam hits the exact centre of the bottom scanning mirror. If not, use dichroic mounts DF5 to adjust the beam path accordingly (diagram below). To adjust the dichroic mount use the two adjustment knobs – each works for one axis.
6. Create a cyan beam effect (point) and check visually whether the green beam hits the exact centre of the blue beam at the dichroic filter DF2. If not, use dichroic mounts DF1 to adjust the beam path accordingly. To adjust the dichroic mount use the two adjustment knobs – each works for one axis.
7. Create a full size cyan circle (static tunnel effect) and check whether the green circle overlays the blue circle in all points around the shape. If not, use dichroic mount DF2 to adjust the beam path accordingly. To adjust the dichroic mount use the two adjustment knobs – each works for one axis.
8. Create a full size yellow circle (static tunnel effect) and check whether the green circle overlays the red circle in all points around the shape. If not, use dichroic mount DF3 and/or DF4 to adjust the beam path accordingly. To adjust the dichroic mount use the two adjustment knobs – each works for one axis.

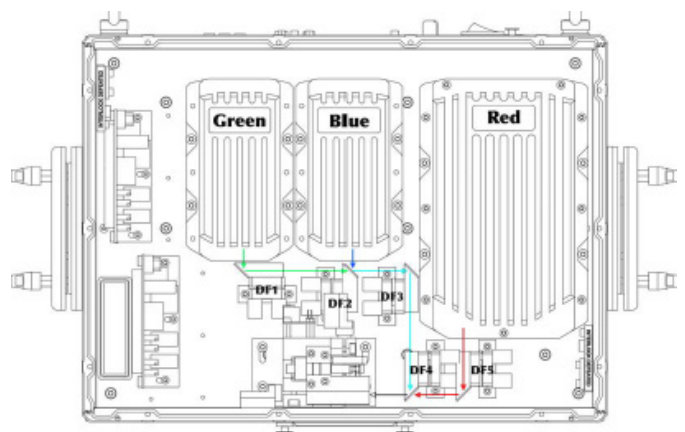

9. Finally create a full size white circle (static tunnel effect). If the alignment procedure was done successfully you can see all the colours nicely overlaying each other, resulting in even, bright and sharp circle like the one on the picture below.

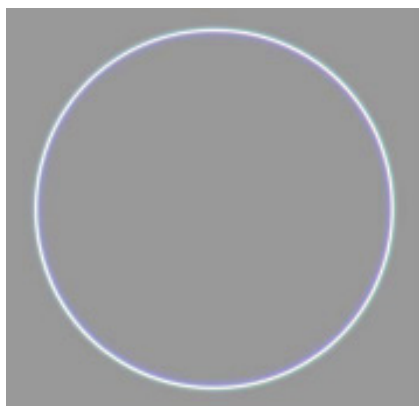

BEAM ALIGNMENT WITH MOTORISED DICHROID FILTERS

1. Adjusting colours directly from BeamBrush interface



A : Power up the system as standard.



B : Create a full-size white circle (static tunnel effect).



C : Find Beam Alignment option in the menu and enter it by pressing the rotary knob.

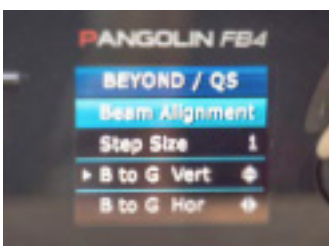

D : Here you can set the STEP SIZE (*amount of movement in a single step*), and VERTICAL / HORIZONTAL movement for every colour in your projector (*R =RED, G =GREEN, B =BLUE, Y =YELLOW*).

2. Adjusting colours from Beyond software

Beyond automatically identifies Motorised Dichroid Filters when the laser projector is connected (and powered up) to the PC via Ethernet.



A : Power up the system as standard and create a full-size white circle (static tunnel effect).

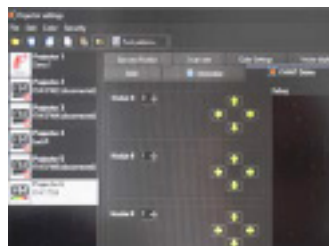

B : Go to : PROJECTOR SETTINGS -> KVANT DICHRO tab. There you will find all the information and control options for the dichroid filters.



C : To start the beam alignment, press the READ STATUS button.

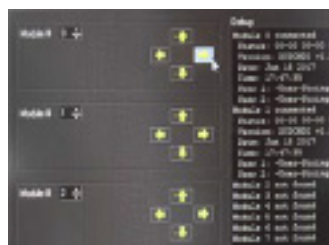

D : Start with the first dichroid filter (laser module1) and/or any other as necessary. Use the arrows associated with each module to move the beam to the desired position.

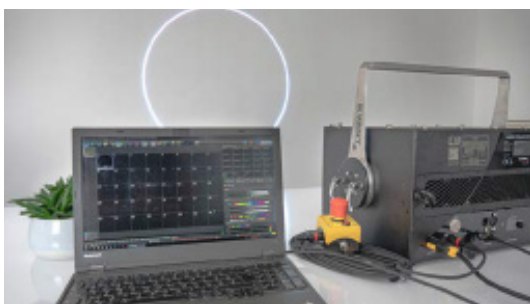

When the alignment procedure is successful, you will see all the colours nicely overlaying each other, resulting in an even, bright and sharp white circle.

COLOUR BALANCE DISPLAY MODE

The primary function of the Colour Balance button is to achieve similar colors of the laser output as on your computer screen. This function is enabled, when its respective LED indicator is illuminated. The color balancing is performed by decreasing some of the intensity of some colors, so you will never get full rated power from the projector when the Colour Balance is enabled. The Colour Balance function is available for the following modes of operation:

- FB4 is in „ILDA Input” mode
- FB4 is in „Beyond/QS mode” and Beyond software is used, BUT „Advanced Mode” is not active
- FB4 is in „Beyond/QS mode” and QuickShow software is used (no „Advanced Mode” available)
- standard frames from SD card are used in DMX, Art-Net and Autoplay mode



TECHNICAL SPECIFICATIONS

All the technical specifications are subject to change without prior notice.

BB

BeamBrush gives you instant zoom, wash, waving and positioning; combined with the razor sharp coherent profile of laser. So you can move from a classical moving head appearance, to a razor sharp laser look, instantaneously.

TECHNICAL SPECIFICATIONS [BEAMBRUSH 3000]

KVANT BeamBrush 3 – full colour, semiconductor diode laser system

Total Optical Power (guaranteed): 3W*

Maximum Output Power: 3.48W

**Due to Advanced Optical Correction technology used in our laser systems the optical power output of each laser colour within the system may slightly differ from the specification of respective laser module(s) installed. This does not affect the guaranteed total power output.*

NOHD (Nominal Ocular Hazard Distance for guaranteed power output): 350m

Beam diameter at laser aperture: 4.5 × 4.5mm

Beam divergence (BeamBrush inactive, half angle):

Red: 0.3mrad

Green: 0.4/0.2mrad

Blue: 0.4/0.2mrad

Modulation: 0-5V analog, up to 100kHz

Module cooling: TEC

Scanning System:

ScannerMAX 506 Compact, 40kpps@8°, max. scanning angle 60° on both axes

Saturn 1, 60kpps@7°, max. scanning angle 60° on both axes (optional)

Colour	Wavelength	Power installed
Red	637nm	>680mW
Green	520nm	>900mW
Blue	445nm	>1500mW
Total		>3080mW

Control signal: Ethernet, DMX/ArtNet, ILDA, SD card (via inbuilt FB4 control interface)

Power requirements: 100-230V/50 - 60Hz / Neutrik powerCon TRUE1

Consumption: 340VA/100-230V

Operation temperature: 10-40°C

Ingress protection rating: IP20

Dimensions (WxDxH): 339 × 270 × 168mm

Weight: 8.8kg

Laser safety features: Keyed interlock, emission delay, magnetic interlock, scan-fail safety,

fast electromechanical shutter | reaction time <20ms,

adjustable aperture masking plate. This laser system fully complies with the latest EN 60825-1:2014, FDA regulations and TUV Laser Safety.

TECHNICAL SPECIFICATIONS [BEAMBRUSH 6800]

KVANT BeamBrush 6,8 – full colour, semiconductor diode laser system

Total Optical Power (guaranteed): 6.8W*

Maximum Output Power: 7.4W

**Due to Advanced Optical Correction technology used in our laser systems the optical power output of each laser colour within the system may slightly differ from the specification of respective laser module(s) installed. This does not affect the guaranteed total power output.*

NOHD (Nominal Ocular Hazard Distance for guaranteed power output): 580m

Beam diameter at laser aperture: 4.5 × 4.5mm
 Beam divergence (BeamBrush inactive, half angle):
 Red: 0.4/0.3 mrad
 Green: 0.4/0.2 mrad
 Blue: 0.4/0.2 mrad

Modulation: 0-5V analog, up to 100kHz
 Module cooling: TEC

Scanning System:
 ScannerMAX 506 Compact, 40kpps@8°, max. scanning angle 60° on both axes
 Saturn 1, 60kpps@7°, max. scanning angle 60° on both axes (optional)

Colour	Wavelength	Power installed
Red	637nm	>2000mW
Green	520nm	>1800mW
Blue	445nm	>3000mW
Total		>6800mW

Control signal: Ethernet, DMX/ArtNet, ILDA, SD card (via inbuilt FB4 control interface)
 Power requirements: 100-230V/50 - 60Hz / Neutrik powerCON TRUE1
 Consumption: 340VA/100-230V
 Operation temperature: 10-40°C
 Ingress protection rating: IP20
 Dimensions (WxDxH): 339 × 353 × 168mm
 Weight: 11.6kg
 Laser safety features: Keyed interlock, emission delay, magnetic interlock, scan-fail safety, fast electromechanical shutter | reaction time <20ms, adjustable aperture masking plate. This laser system fully complies with the latest EN 60825-1:2014, FDA regulations and TUV Laser Safety.

TECHNICAL SPECIFICATIONS [BEAMBRUSH 10]

KVANT BeamBrush 10 – full colour, semiconductor diode laser system

Total Optical Power (guaranteed): 9.7W*

Maximum Output Power: 10.4W

**Due to Advanced Optical Correction technology used in our laser systems the optical power output of each laser colour within the system may slightly differ from the specification of respective laser module(s) installed. This does not affect the guaranteed total power output.*

NOHD (Nominal Ocular Hazard Distance for guaranteed power output): 578m

Beam diameter at laser aperture: 4.5 × 4.5mm

Beam divergence (BeamBrush inactive, half angle):

Red: 0.5 mrad

Green: 0.6/0.2 mrad

Blue: 0.7/0.2 mrad

Modulation: 0-5V analog, up to 100kHz

Module cooling: TEC

Scanning System:

ScannerMAX 506 Compact, 40kppts@8°, max. scanning angle 60° on both axes

Saturn 5, 50kppts@7°, max. scanning angle 60° on both axes (optional)

Colour	Wavelength	Power installed
Red	637nm	>2500mW
Green	520nm	>2800mW
Blue	445nm	>4500mW
Total		>9800mW

Control signal: Ethernet, DMX/ArtNet, ILDA, SD card (via inbuilt FB4 control interface)

Power requirements: 100-230V/50 - 60Hz / Neutrik powerCON TRUE1

Consumption: 340VA/100-230V

Operation temperature: 10-40°C

Ingress protection rating: IP20

Dimensions (WxDxH): 339 × 353 × 168mm

Weight: 13kg

Laser safety features: Keyed interlock, emission delay, magnetic interlock, scan-fail safety,

fast electromechanical shutter | reaction time <20ms,

adjustable aperture masking plate. This laser system fully complies with the latest EN 60825-1:2014, FDA regulations and TUV Laser Safety.

TECHNICAL SPECIFICATIONS [BEAMBRUSH 35]

KVANT BeamBrush 35 – full colour, semiconductor diode laser system

Total Optical Power (installed): 38W

Total Optical Power (guaranteed): 38W*

**Due to Advanced Optical Correction technology used in our laser systems the optical power output of each laser colour within the system may slightly differ from the specification of respective laser module(s) installed. This does not affect the guaranteed total power output.*

NOHD (Nominal Ocular Hazard Distance for guaranteed power output): 2193m

Beam diameter at laser aperture: 6x6.5mm
 Beam divergence: <1mrad (BeamBrush inactive, half angle)
 Modulation: 100 kHz I analog – 100 kHz
 Module cooling: TEC

Scanning System:
 Saturn 9, 30kpps@7°

Colour	Wavelength	Power installed
Red	638nm	>7500mW
Green	525nm	>10500mW
Blue	455nm	>20000mW

Control signal: Ethernet, DMX/ArtNet, ILDA, SD card (via inbuilt FB4 control interface)
 Power requirements: 100-240V/50Hz (±5%)
 Consumption: 1000VA/100-240V
 Operation temperature: 10-40°C
 Ingress protection rating: IP20
 Dimensions (WxDxH): 510 x 273 x 396mm
 Weight: 30KG(+/-10%)
 Laser safety features: Keyed interlock, emission delay, magnetic interlock, scan-fail safety, V-RAD 506 mechanical shutter I reaction time <20ms, adjustable aperture masking plate. This laser system fully complies with the latest EN 60825-1, FDA regulations and TUV Laser Safety.

40

TROUBLESHOOTING

Q: My projector's aperture glass is cracked, broken or missing. Can I continue using my projector?

A: Laser beams hitting glass splits will be scattered into unwanted directions, creating a risk of damage to eyesight, health or property. Broken or missing aperture glass enables humidity, water, and dust inside the laser projector's optical compartment, which can cause permanent damage to the system.

It is essential to replace the damaged or missing aperture glass before using the laser projector.

Q: The housing of the projector is damaged. Can I continue using my projector?

A: The projector must not be operated if the housing is damaged to the level that it causes visible gaps between the projector's adjacent faces. The gaps enable humidity, water, and dust inside the laser projector's optical compartment, which can cause permanent damage to the system. There is also a risk of laser emission leaks from other parts of the system, which contradicts the IEC 60825-1 safety standard. Damaged housing parts must be repaired or replaced before operating the projector again.

Q: Projector's eyebolt is bent, fractured or unscrewed. Can I continue using my projector if it is installed using the eyebolt as a safety mechanism? Or continue with the installation?

A: No! The projector must not be used, lifted or hanged. Never attempt to repair bent or fractured eyebolt. Replace it with a new one with the same or higher load capacity.

Q: Is it OK that the cooling fans are not running during operation?

A: Yes, it's OK. Kvant projectors have built-in automatic regulation of the fan speed. After powering up the projector, all cooling fans will run at 100% speed for about 2 seconds. Then their speed is adjusted according to the heatsink's temperature.

Clubmax (without FB4):

if heatsink's temperature is below 25°C (77°F), the fans are turned off. Within the range of 25°C (77°F) to 55°C (131°F), the fan speed increases with increasing temperature of the heatsink, and over 55°C (131°F) they run at full speed.

BeamBrush, Clubmax FB4, Atom and Spectrum series:

if heatsink's temperature is below 15°C (59°F), the fans are turned off or run at low speed. Within the range of 15°C (59°F) to 33°C (91°F), the fan speed increases with increasing temperature of the heatsink, and over 33°C (91°F) they run at full speed.

Q: Is it OK if some fans are running at full speed and some at low speed during the operation?

A: Yes, it is OK. Kvant Atom and Spectrum projectors use multi-zone regulation of the fan speeds. Fans that cool down warmer sections of the heatsink work at higher speeds. The correct functionality of all fans can be checked anytime by power cycling the projector. After powering up the projector, all cooling fans will run at 100% speed for about 2 seconds. Then their speed is adjusted according to the heatsink's temperature.

Q: Cooling fans generate a strange noise. Is that a problem?

A: Strange noise is usually caused by an object stacked in the fan's propeller area. It can be a piece of confetti or plastic or even a hardened mixture of smoke residue and dust. Check the fans and if such an obstruction is found, turn the projector off and remove it. Another reason for the noisy fans could be its damaged propeller or bearings. If that's the case, then the fan needs to be replaced with a new one of the same type.

Q: Shutter doesn't open, and its plate blocks the output (in ILDA operation mode).

A: In the ILDA operation mode, the shutter is also controlled with the "shutter" signal from an external controller. Check the ILDA cable, mainly if pin #13 is connecting properly. We recommend using only original ILDA cables.

Q: Shutter doesn't open, and its plate blocks the output.

A: If the shutter doesn't open in any operation mode, please contact your distributor or technical assistance of Kvant Lasers, s.r.o.

Q: The projector is powered ON, ready for emission, but the FB4 display is inactive. And it doesn't turn on after pushing or turning the encoder knob next to the FB4 display.

A: Perform a power cycle procedure with the mains power switch or unplugging the mains power cable for 5 seconds. After the power cycle, the display should start working correctly.

Q: One of the RGB colours doesn't work.

A: Check colour settings in the FB4 menu and make sure that all R, G and B colours are set at 100%. If the projector doesn't have a built-in FB4 controller, check the brightness potentiometers at the rear panel - all three should be set to the maximum level.

If all the above is as described and the problem persists, turn off the mains power switch (or disconnect the mains power cord) for 10 minutes.

All PSUs should fully discharge and cool down.

After 10 minutes, power up the projector. If overloaded PSUs caused the malfunction, it should now work correctly again.

Q: One of the RGB colours doesn't work (ILDA operation mode only).

A: Check connection on both ends of the ILDA cable and inspect the ILDA male connector's pins.

Q: Scanning is unstable or distorted on both the X and Y axes (ILDA operation mode only).

A: Distortion of the scanned effects can occur when the projector and the PC (controller) are not connected to the same mains power phase due to different PE wire potentials (Earth).

Always connect the PC/controller and the laser projector to the same mains power socket when operating in ILDA mode.

Q: The projection size is reduced to about 50% on one or both of the X and Y axes.

A: Check Master Settings in the FB4 menu and ensure both axes size are set to 100% size. If the projector doesn't have FB4 controller build-in, ensure both X and Y potentiometers located on the rear panel are set to the maximum level.

If all the above is as described and the problem persists, check ILDA cable connectors on both sides and the ILDA input connector on the projector. One or more of #1, #2, #14, #15 pins may be bent or damaged.

Q: One colour of the projected effect is shifted out from others - misaligned.

A: It is necessary to reset the output directions (alignment) of individual colours (laser beams) inside the projector. There are several ways how to join them together, but only one is correct. The correct one ensures perfectly joined beams at both short and long-distance projections. Please check the User manual (chapter Beam alignment) for beam alignment instructions.

Q: Projector #2 doesn't work when connected to the ILDA output of projector #1.

A: Try to replace the ILDA cable with a new one between projectors and check the ILDA input connector on projector #2 for any damage. If this does not solve the issue, exchange the projectors one for another and see if that works. If both work fine, then projector #1 has faulty ILDA output. If none of them is working, then projector #2 has faulty ILDA input. Please contact your distributor or technical assistance of Kvant Lasers, s.r.o. for further help.

Q: Projection is blurred or foggy. Static beams (points) have a halo around them. How to fix this?

A: This is usually an optical problem such as scratches, dust and dirt on the components on the beams' path from their source to the output aperture; or on the aperture glass itself. Use a clean fine-cotton cloth soaked with isopropyl alcohol to clean the surface of the output window. Clean it carefully so you won't scratch the surface with dirt particles already stacked to the cloth.

Remember that the output window's anti-reflex surface can be easily scratched and permanently damaged by an incorrect cleaning process.

Q: Projection is blurred or foggy; static beams (points) have a halo around them, but the output window is clean. How to fix this?

A: This is usually an optical problem such as scratches, dust and dirt on the components on the beams' path from their source to the output aperture (scanner mirror, dichroic filter, bounce mirror). To inspect and clean the optical components, the projector must be turned off and disconnected from the mains power supply.

Use a clean cotton bud (swab) soaked with isopropyl alcohol to clean the optical component's surface. The bud must be "rotated" against movement direction during cleaning to avoid the surface get scratched by dust and dirt already taken from the surface. After one whole spin (360 deg), dispose of the cotton bud and take a new cotton bud to continue the cleaning process. Remember that the optical parts' surface can be easily scratched and permanently damaged by an incorrect cleaning process.

Q: One of the colours fades out and then goes back to its full power. This repeats. Why is this happening?

A: The laser projector has automatic over-temperature protection, decreasing the individual laser module's power output to 50% if its temperature goes above the preset level. After stabilization of temperature, the output power goes back to 100%. If the temperature at 50% power output still rises, the power output is cut to zero until the temperature returns to safe values.

If the projector reduces the power output of one or more colours, the reason for it could be insufficient cooling caused by lack of airflow, too warm cooling air, or faulty fans on the main heatsink.

Q: The projection suddenly lost a significant amount of blue colour. The colour tone of all RGB effects changed, and the total power output decreased too. Why?

A: The most likely reason is the activated Colour Balance function, which balances all the primary colours in the correct ration for all the mixed colours to be precisely right. For example, projected white is nice and crisp, without discolouration towards blue. To enable or disable this function, press the little button next to the FB4 display on the rear panel. This feature is switched ON when the yellow LED indicator next to this button is on. When the Colour Balance function is disabled, all the colours go back to 100% power output.

Q: How many projectors can I daisy-chain with E-STOP Remote?

A: The number of projectors running on a single E-STOP Remote is unlimited. Each projector amplifies the E-STOP signal for the next projector in line.

Q: What is the maximum distance of the E-STOP connection between two projectors?

A: The maximum length between two projectors is defined by the internal resistance of used cable connection wires. The total resistance of one wire within connection must be below 400 Ohm. Standard microphone XLR cables have resistance typically below 0,1 Ohm/meter. So the maximum distance between two projectors with such cable is approximately 4km.

Q: How many projectors can I daisy-chain with a single Ethernet line (PC OUT-> IN1, OUT1-> IN2, OUT2-> IN3...)?

A: We recommended daisy-chaining a maximum of 6 units on a single Ethernet line. If you connect more than six projectors, the data packet losses will most likely be noticeable, resulting in a disruptive movement of projected graphics and animations.

For the best possible quality of multi-laser data connection, it is recommended to use a high-speed 1Gbit data connection between PC and data switch. Also, it is recommended to separate 100Mbit data connections between the data switch and each projector.

Q: Is it possible to connect a door switch as a safety measure to interrupt the laser emission?

A: Yes. Laser projectors supplied to the US market come with an E-STOP Remote with Auxiliary Input for Normally Closed (NC) door switch.

Into this input, the client can connect either an interlock jumper, a door switch or any additional safety item, e.g. output of PIR sensor for observing the area around the laser projector.

Q: Is this projector compatible with other Kvant projectors?

A: All Kvant projectors manufactured from 06/2014 and later are fully compatible with each other. To check and ensure compatibility with older Kvant projectors made prior 05/2014, please contact the technical support representative of Kvant Lasers, s.r.o.

Suppose Spectrum LD projector with Saturn9 scanning set is used with non-LD projectors. In that case, it is recommended to decrease the maximum size and scan rate of the non-LD system(s) to meet the LD system limits and full compatibility. If more systems from various manufacturers are used together, it is recommended to use a separate ILDA signal source for each manufacturer's group.

Q: The projector has been exposed to rain during an outdoor show without the Rain Cover installed. What shall I do next?

A: It is necessary to remove the laser projector from its flight case as soon as possible - within 24 hours at the latest after the show, and let both projector and flight case fully dry out.

NEVER turn ON the projector before it is 100% dry inside out.

When ready, please check the status of the anti-humidity cassette containing silica gel. For more information about this topic, go to the User manual (chapter Maintenance). Insufficient drying of the projector and its flight-case can cause permanent damage to the projector (mould, corrosion) and voids the warranty. Powering up wet or dump projector can cause electrical shock, injury, or fire risk. It can also cause permanent damage to the projector, in which case the warranty is voided.

Q: Is the Rain cover accessory suitable for long term protection against outdoor weather conditions?

A: No. The Rain cover was designed as emergency protection against rain or snow for short term outdoor use. During intense precipitation and winds, it can get soaked with water. Therefore, removing the rain cover from the projector after every use and letting it dry together with the projector is necessary. Insufficient drying of the projector and its flight-case can cause permanent damage to the projector (mould, corrosion) and voids the warranty. Powering up wet or dump projector can cause electrical shock, injury, or fire risk. It can also cause permanent damage to the projector, in which case the warranty is voided.

Q: Is it possible to use the Rain cover for a projector that is set other than horizontally (i.e. when projecting upwards)?

A: No. Our Rain cover works efficiently ONLY for projectors set in a horizontal position - that's with rubber feet towards the ground.

If the Rain cover is used any other way, it won't protect your equipment.

Q: At low temperatures, the laser projector won't start.

A: The operating temperature range for Kvant laser projectors is +10°C (50°F) to +35°C (95°F).

If used outside of this range, we recommend using the Kvant Monsoon. This robust and durable enclosure will protect your delicate equipment, such as laser projectors, against harsh weather conditions, extreme temperatures and high humidity. As a temporary solution, you can use an electric heater to pre-heat the air entering the laser projector. Place the heater at the correct distance from the projector, so when the air enters the laser projector, it is within the range +10°C (50°F) to +25°C (77°F). The projector may get damaged if the heater is placed too close to the projector's airflow inlets or rear control panel.

Q: Laser projector stops working or even won't start at high ambient temperatures.

A: The operating temperature range for Kvant laser projectors is +10°C (50°F) to +35°C (95°F). Using projectors in an environment with air temperatures within 35°C (95°F) to 45°C (113°F) is not harmful to the projector, but limits its ability to disperse the heat efficiently, resulting in lowered nominal power output or complete cutoff.

There is a risk of permanent damage to the laser projector if used in temperatures exceeding 45°C (113°F), in which case the warranty is voided.

Never place and use projectors near objects that generate excessive heat, such as radiators, powerful discharge lighting, or warm air outlets.

For the use in temperatures exceeding 35°C (95°F), installing the projector into the Monsoon box with a built-in AC unit is highly recommended.

As a temporary solution, you can use a small AC unit and direct it's output towards the projector's intake fans.

Q: Is it possible to do modifications to the electronic circuitry of the laser projectors?

A: It is not allowed to modify the electronic circuitry of laser projectors without prior authorization and approval of Kvant's technical support representative. Any unauthorized modifications will result in immediate warranty termination.

There is a risk of electric shock and the risk of injury or property damage by laser radiation. Unauthorized modifications of the circuitry may cause a change in the projector's functionality and specifications, making it incompliant with regulations and standards of Class IV laser devices.

Q: What if I feel a small electric shock when touching the metal parts of the projector's housing?

A: Turn off the projector immediately. Disconnect the projector from the AC mains power supply. A qualified electrician must check the mains power cable and the socket.

The two common reasons are:

1. Too long AC mains power cable with joined cables N (blue) and PE (yellow-green). The 3-wire connection is essential.
2. Disconnected, not connected, or interrupted PE wire in AC mains power cable or AC wall plug.

Q: What if I feel a pretty strong electric shock when touching the metal parts of the projector's housing?

A: There is a danger of fatal electric shock! Turn off the projector immediately. Disconnect the projector from the AC mains power supply. A qualified electrician must check the mains power cable and the socket.

Q: Can anybody operate the laser projector?

A: No. The laser projector should be operated by an adult person who passed their training as a Laser Display Operator of Class 4 laser devices. The operator should be aware of and follow all the regulations, requirements, and laws regarding a country where operating the Class 4 laser system.

The manufacturer holds no responsibility for injuries or damages caused by the use of this laser display equipment.

Q: Where can I find the Conformity Declaration (CE) for this laser projector?

A: Conformity Declaration is part of the user manual. Because the corresponding standards are updated from time to time, please contact a distributor or one of our sales representatives to obtain the latest Conformity Declaration for your laser projector.

Q: How can I ecologically discard an old laser projector?

A: Laser projector doesn't contain any poisonous materials or dangerous components. Therefore, you can ecologically discard it the same way you would do any old electronic equipment. For more details, please contact your local waste authority.

CONTACT INFORMATION

Address:

Kvant Lasers s.r.o.
Odborárska 23
831 02 Bratislava
Slovakia, Europe

e-mail: info@kvant.sk

Telephone: 00421-2-654 113 55

Technical support contact:

e-mail: micek@kvant.sk

Telephone: +421 918 339 980

Address:

Pangolin Laser Systems, Inc.
1265 Upsala Road, suite 1165
Sanford, FL 32771

Technical support contact:

e-mail: support@pangolin.com

Telephone: +(407) 299-2088