

PRODUCT CATALOGUE 2019

LASER MODULES

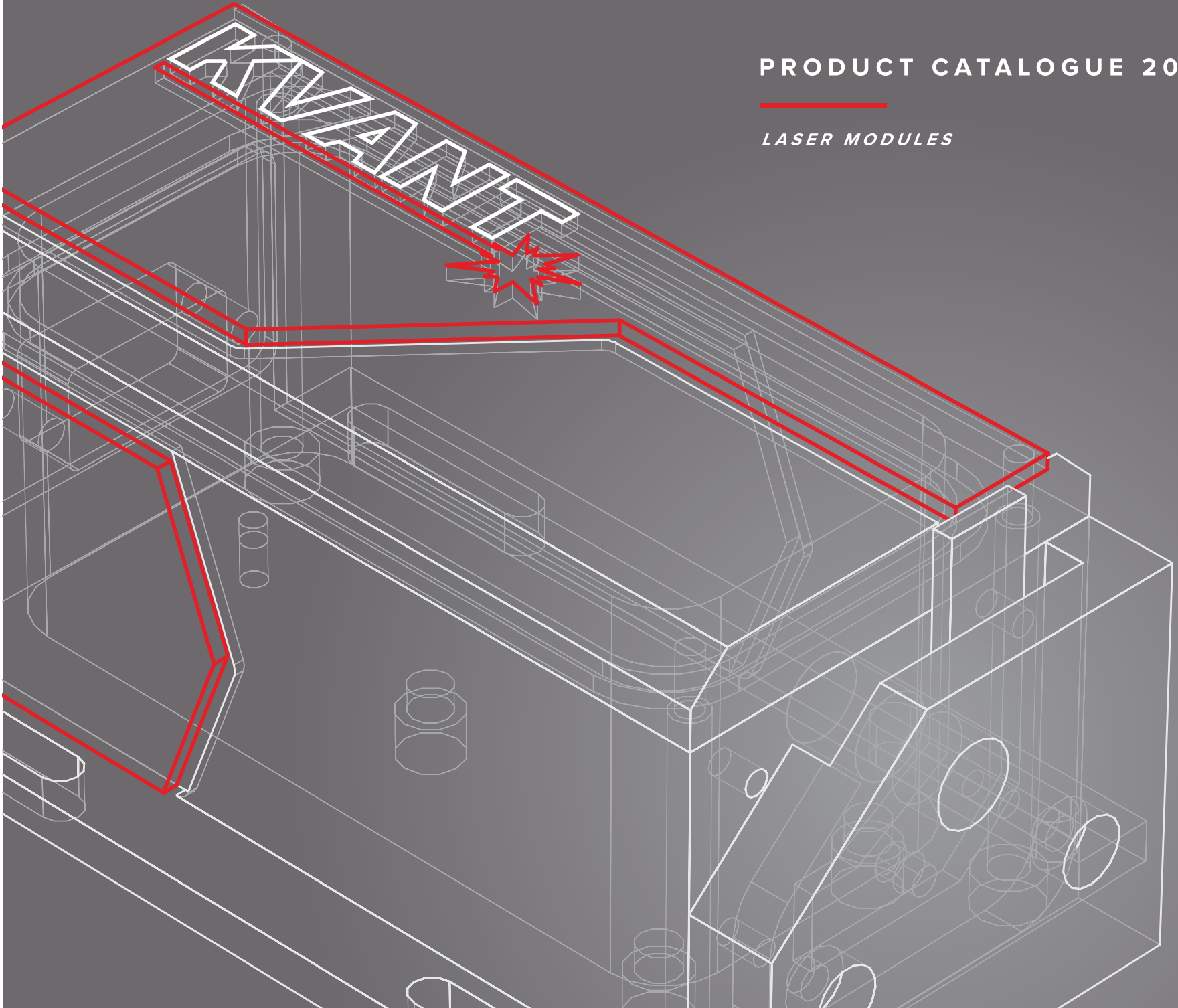



Static laser beam in Bratislava / permanent installation

About Kvant Lasers

Kvant Lasers Ltd. produces laser systems for R&D, industry, military, advertisement, art, architecture, medical and display applications.

Kvant Lasers Ltd. is a part of Kvant Ltd. family that was established in 1995 focusing mainly on the development and production of new laser solutions demanded by the worldwide market. During the last 24 years the assortment and quality of products has increased together with the experience and knowledge of our engineers and manufacturers. Our effort is focused on top quality, reliability, superior services, low price and a wide product range to meet demands of every customer.

Our R&D team has invented several industrial designs and patents in many laser related fields including laser beam shaping and the modification of laser light parameters. Ongoing research and product development is carried out under the same roof as our production line. In our 1,800 sq.M floor buildings in the capital city of Bratislava with over 50 employees. We only use components from reputable American, Japanese, German and Slovak

manufacturers. All our products meet international and EU safety requirements.

KVANT LASERS is at the cutting edge of research into laser technology with our researchers in cooperation with Slovakian and German institutions and other academic institutions worldwide. Our expertise allows us to offer any laser system custom built to your exact specifications and requirements.

Laser Power

and wavelength range overview of modules

Our mission is to ensure that a uniform and quality beam comes out of every KVANT laser module.

Kvant offers laser modules with wavelengths from deep UV to NIR and power ranges from a few milliwatts up to tens of watts. Single diode lasers, multi-diode assemblies as well as solid state lasers can be combined into a single free space beam or fibre coupled output.

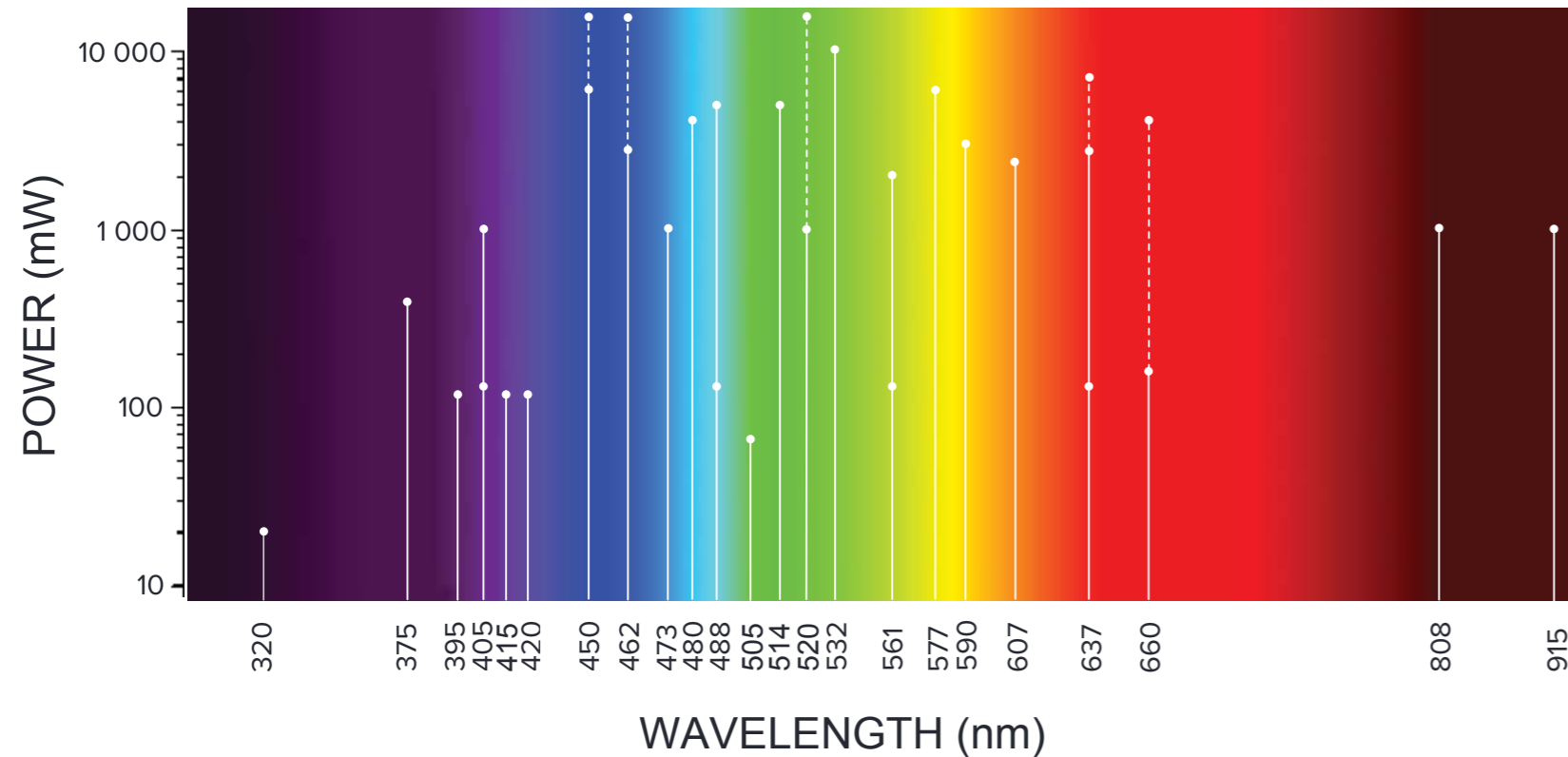

Solid State Lasers

UV and visible

Our Blue Light Pumped (BLP) solid state lasers are based on innovative laser technology. The InGaN-based pumping laser diode and fluoride crystals are a good base for durability and long lifetime.

A few years ago we invented our popular orange and red lasers based on this new technology. Recently we introduced our first UV laser with 320nm wavelength and a few milliwatts of power that is supposed to substitute the current HeCd metal ion gas lasers and is very close to nitrogen, excimer and some other gas lasers.

Its application can be found in biotechnology, medicine, microelectronics technology, etching substrates or polymerisation. We are currently improving our technology to get higher power and even shorter wavelength.

Model Nr.	OLM-180	RLM-400	UV1-20	UV2-20
Optical power (mW)	> 180	> 400	5-20	> 20
Centre wavelength (nm)	607	639	304	320
Centre wavelength tolerance (nm)	± 1	± 1	± 1	± 1
Beam diameter (95% of power, horizontal*vertical, mm)	3.2	2.8	Currently under development	
Beam diverg. (half angle,mrad)	0,16	0,17		
Linear polarization	Y	Y		
M2	< 1,1	< 1,1		
Modulation freq.(kHz)	-	-		
Peak power cons.	24V / 2.5A	24V / 2.5A	24V / 2.5A	24V / 2.5A
Dimensions (LxWxH,mm)	120x59x40	120x59x40	120x60x44	120x60x44
Driver dimensions (LxWxH,mm)	117x89x34	117x89x34	117x89x34	117x89x34



Single Diode Modules

KVANT's diode laser modules are equipped with high-quality laser diodes designed by prestigious laser diode manufacturers.

We cover all wavelengths in UV and visible range that are available with laser diodes, mainly focused on high power output. All modules are temperature stabilised to yield maximum lifetime, optimal performance and power stability. The driving electronics allows analogue modulation up to 100 kHz with linear response between the modulation signal and laser output power. Fibre coupling is possible for most of the lasers.



Dual Michelson interferometer

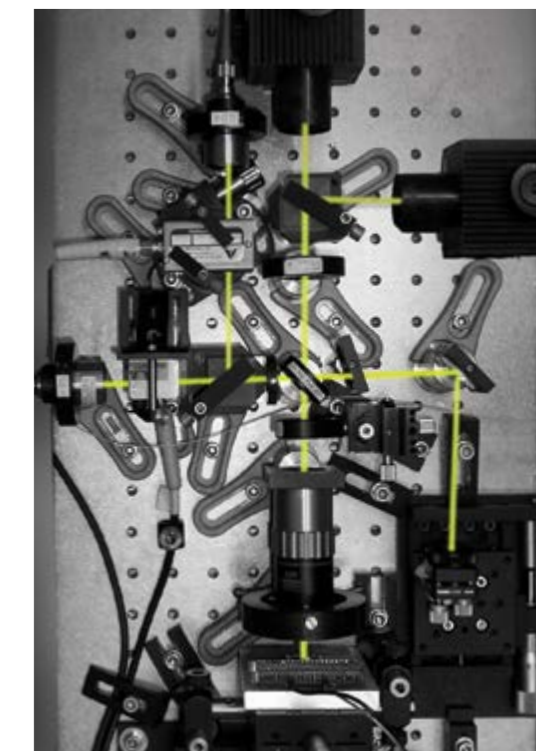

Model Nr.	375LM-70	375LM-200	375LM-400	395LM-120	405LM-200	405LM-300	405LM-500	405LM-1.2k	405LM-3.5k	415LM-120	420LM-120	445LM-100	445LM-500	445LM-1.5k
Optical power (mW)	70	200	400	120	200	300	500	1200	3500	120	120	100	500	1500
Centre wavelength (nm)	375	375	375	395	405	405	405	405	405	415	420	445	445	445
Centre wavelength tolerance (nm)	± 5	± 5	± 5	± 5	± 5	± 5	± 5	± 5	± 5	± 5	± 5	± 5	± 5	± 5
Beam mode structure	TEM00	Multimode	Multimode	TEM00	TEM00	TEM00	Multimode	Multimode	Multimode	TEM00	TEM00	TEM00	Multimode	Multimode
Beam diameter* (1/e ² , mm)	4	3.5 x 3.5	~ 4 x 4	4	4	4	~ 4 x 4	3.5 x 3.5	3.5 x 3x5	4	4	4	4 x 4	4 x 4
Beam diverg. (half angle,mrad)	0.2	0.5 x 0.15	-	0.2	0.2	0.2	0.5 x 0.3	0.8 x 0.2	-	0.2	0.2	0.2	0.3 x 0.2	0.5 x 0.2
Linear polarization	Y	Y	Y	Y	Y	Y	Y	Y	Y	Y	Y	Y	Y	Y
M2	~1	-	-	~1	~1	~1	-	-	-	~1	~1	~1	-	-
Max. modulation freq.(kHz)	10	10	10	10	10	10	10	10	10	10	10	10	10	10
OEM driver** peak power cons.	24V / 2A	24V / 2A	24V / 2A	24V / 2A	24V / 2A	24V / 2A	24V / 2.5A	24V / 2.5A	24V / 2.5A	24V / 2A	24V / 2A	24V / 2A	24V / 2.5A	24V / 2.5A
Head dimensions (LxWxH,mm)	87x60x45	87x60x45	87x60x45	87x60x45	87x60x45	87x60x45	87x60x45	87x60x45	87x60x45	87x60x45	87x60x45	87x60x45	87x60x45	87x60x45

445LM-3.5k	445LM-5k	455LM-100	462LM-1.4k	473LM-100	473LM-300	473LM-1k	488LM-60	488LM-200	488LM-2k	505LM-80	520LM-60	520LM-950	637LM-180	638LM-700	638LM-1.2k	660LM-160	660LM-1k
3500	5000	100	1400	100	100	1000	60	200	2000	80	60	950	180	700	1200	160	1000
445	442	455	462	473	473	473	488	488	488	505	520	520	637	638	638	660	660
± 5	± 5	± 5	± 5	± 5	± 5	± 5	± 5	± 5	± 5	± 5	± 5	± 5	± 5	± 5	± 5	± 5	± 5
Multimode	Multimode	TEM00	Multimode	TEM00	TEM00	Multimode	TEM00	TEM00	Multimode	TEM00	TEM00	Multimode	TEM00	Multimode	Multimode	TEM00	Multimode
3 x 4	3 x 4	4	4 x 4	4	4	4 x 4	4	4	3 x 4	4	4	3.5 x 4	4	3 x 4	3 x 4	4	5 x 5
1.4 x 0.2	1.6 x 0.2	0.2	0.5 x 0.2	0.2	0.2	0.5 x 0.2	0.2	0.2	-	0.2	0.2	0.5 x 0.2	0.2	1.9 x 0.2	2.8 x 0.2	0.2	3 x 0.2
Y	Y	Y	Y	Y	Y	Y	Y	Y	Y	Y	Y	Y	Y	Y	Y	Y	Y
-	-	~1	-	~1	~1	~1	~1	~1	~1	~1	~1	-	~1	-	-	~1	-
10	10	10	10	10	10	10	10	10	10	10	10	10	10	10	10	10	10
24V / 2.5A	24V / 2.5A	24V / 2A	24V / 2.5A	24V / 2A	24V / 2A	24V / 2.5A	24V / 2A	24V / 2A	24V / 2A	24V / 2A	24V / 2A	24V / 2.5A	24V / 2A	24V / 2.5A	24V / 2.5A	24V / 2A	24V / 2.5A
87x60x45	87x60x45	87x60x45	87x60x45	87x60x45	87x60x45	87x60x45	87x60x45	87x60x45	87x60x45	87x60x45	87x60x45	87x60x45	87x60x45	87x60x45	87x60x45	87x60x45	87x60x45

Multi Diode Modules



Some applications require a high power laser beam which cannot be achieved by single emitter laser diodes.

In this instance we combine up to 64 single laser diodes and bundle the individual laser beams into a single output beam. A fibre output in this case is an option too. For most demanding projects a precise wavelength diode selection is possible or gentle wavelength tuning through the diode temperature control. Mixing of several wavelengths to get white or other colour beam

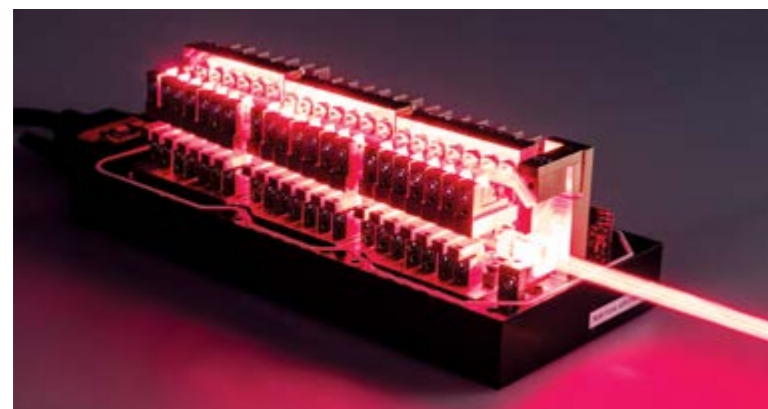

in a single laser module is our strong point. This kind of laser modules is mostly used in laser display, optical crystal pumping, architecture and material processing. Please check our homepage or contact us directly by email to get more details about our multi diode assemblies.

Single colour modules

- 445 nm up to 30 W
- 460 nm up to 30 W
- 520 nm up to 19 W
- 637 nm up to 10 W
- 660 nm up to 7.7 W

Multi colour modules:

- 445+460 nm up to 16 W
- 445+637 nm up to 4.3 W
- 445+520+637 nm up to 3.4 W

Optically Pumped Semiconductor Lasers



KVANT Ltd. is official worldwide integrator of Coherent Inc. Genesis Taipan optically pumped semiconductor laser (OPSL) heads.

All Coherent Inc. heads are equipped with Kvant electronics and delivered as stand-alone laboratory systems or as industrial OEM version for further integration. There are single mode and multimode versions available. The advantage of the OPSL technology is the ability to deliver high output powers at unique wavelengths and excellent beam quality. Over 900 Coherent laser heads have been sold together with our laser systems.

Model Nr.	Blue	Cyan II	Cyan I	Green II	Green I	Yellow II	Yellow I	Orange II	Orange I	Red
Optical power (mW)	1000 2000 *	1000 2000 * 4000	3000 5000	3000 5000	3000 * 5000 * 8000 10000	2000	2000 3000 5000 6000	2000 * 3000	1250	1000 1500 2000 2500 5000
Centre wavelength (nm)	460	480	488	514	532	561	577	590	607	639
Centre wavelength tolerance (nm)	±3	±3	±3	±3	±3	±3	±3	±3	±3	±1
Spectral width (nm)	< 0.5	< 0.5	< 0.5	< 0.5	< 0.5	< 0.5	< 0.5	< 0.5	< 0.5	< 0.5
Beam size (FWHM, mm)	Ø 2.3	Ø 2.3	Ø 2.3	Ø 2.3	Ø 2.3	Ø 2.3	Ø 2.3	Ø 2.3	Ø 2.3	Ø 1
Beam diverg. (full angle,mrad)	1.5	1.5	1.5	1.5	1.5	1.5	1.5	1.5	1.5	1.5
Linear polarization	100:1	100:1	100:1	100:1	100:1	100:1	100:1	100:1	100:1	100:1
M2 (horizontal/vertical)	6 / 4	6 / 4	6 / 4	6 / 4	6 / 4	6 / 4	6 / 4	6 / 4	6 / 4	1.5 / 1.5
Modulation freq.(kHz)	50	50	50	50	50	50	50	50	50	50
Diode power cons.	2.2V / 32A	2.2V / 32A	2.2V / 40A	2.2V / 40A	2.2V / 40A	2.2V / 40A	2.2V / 40A	2.2V / 32A	2.2V / 32A	2.2V / 40A
Driver dimensions of head only (LxWxH,mm)	134x44x65	134x44x65	134x44x65	134x44x65	134x44x65	134x44x65	134x44x65	134x44x65	134x44x65	256x49x71

Controllers

All laser modules are equipped with industrial OEM driver or bench-top laboratory controller.



Industrial controller

The industrial controller with 24 V power input is available either with an external modulation input or with an intensity adjustment knob.



Laboratory controller

Bench-top laboratory laser module controller featuring diode temperature and current settings and measurements on the built-in display with external modulation input on the rear panel.

Scanning Systems

Over 24 years we utilize laser beam steering systems for display industry, automotive, production navigation, engraving, advertisement and medicine.

We implement scanning systems from renowned US manufacturers.

For clients who need a high-performance optical scanning system at an affordable price, the Pangolin's Compact-506 is an ideal solution.

The Cambridge Technology 6215-HP set is one of the best laser display scanner sets on the market and offers fast, precise and reliable scanning.

Due to its unique magnetic circuit and rotor construction the Pangolin's Saturn optical

scanners achieve the highest acceleration among all available 1-3 mm aperture scanners.

Do not hesitate to contact us if you need any custom laser scanning system, with our or your own laser source.



Applications

Biomedicine, fluorescence, spectroscopy, particle and gas analysis, polymerization, dermatology, surgery, advertisement, automotive industry, entertainment, education, at the universities or in the production hall around the world, that is only a part of areas where our clients use our lasers and we would like to acknowledge them for their support and inspiration.



Photo patterning with 375nm Kvant laser in combination with DLP projector

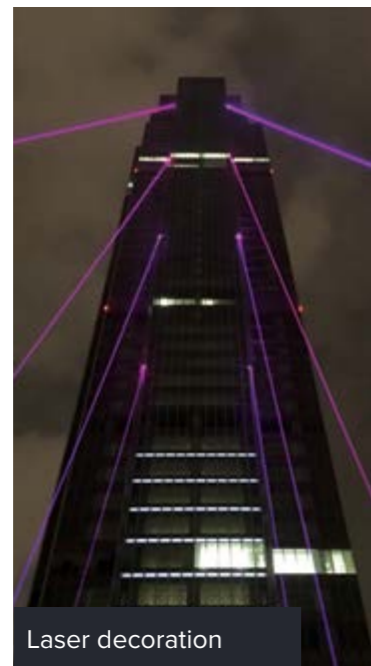

Laser decoration

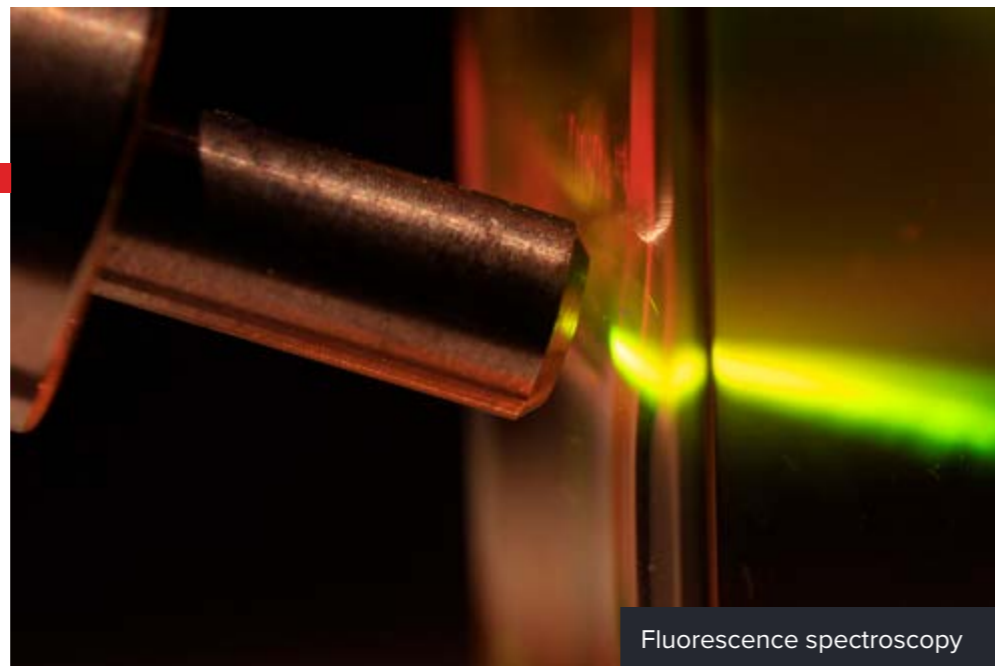

Fluorescence spectroscopy

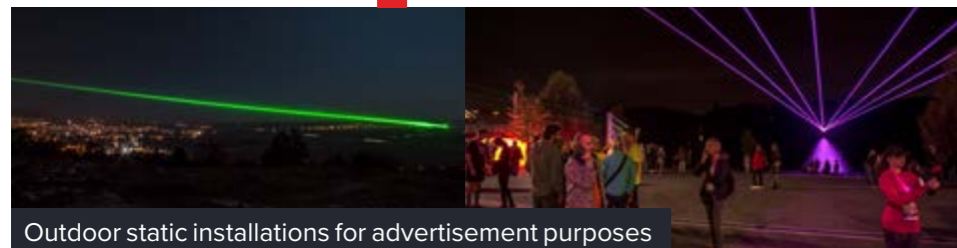

Outdoor static installations for advertisement purposes

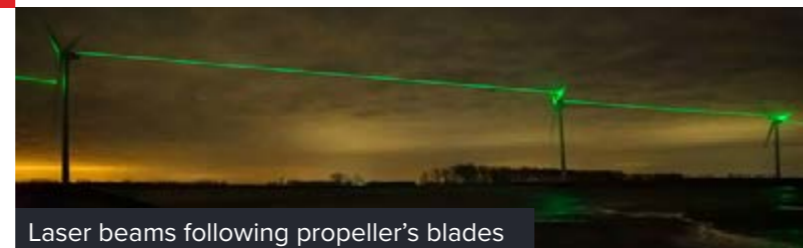

Laser beams following propeller's blades

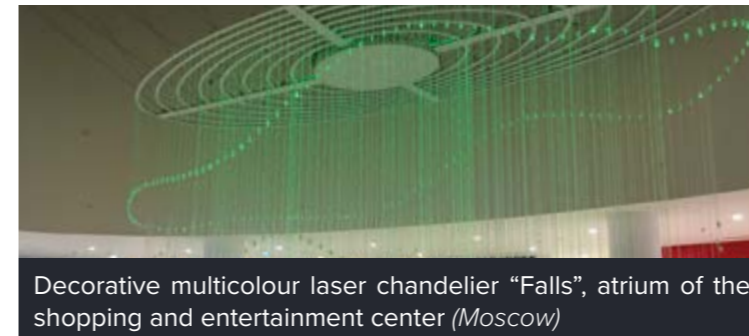

Decorative multicolour laser chandelier "Falls", atrium of the shopping and entertainment center (Moscow)

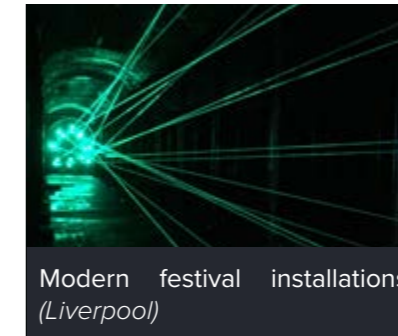

Modern festival installations (Liverpool)

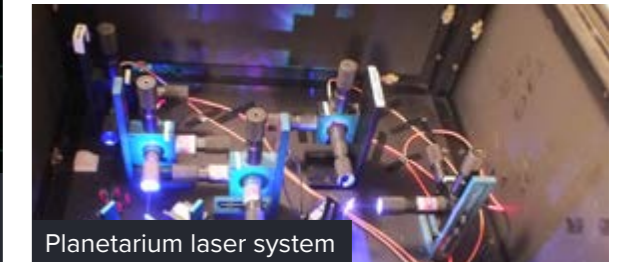

Planetarium laser system



Light absorption analysis in the sea for satellite plankton observation



Photonic crystal Brillouin zone visualization with 405 nm laser.



Outdoor laser line projection at sport events

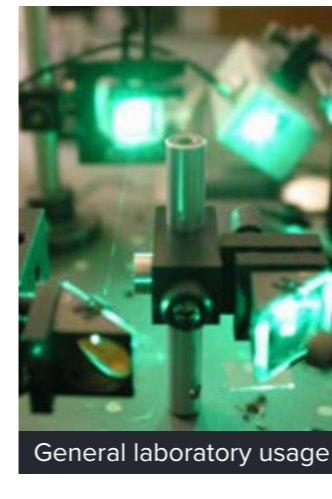

General laboratory usage

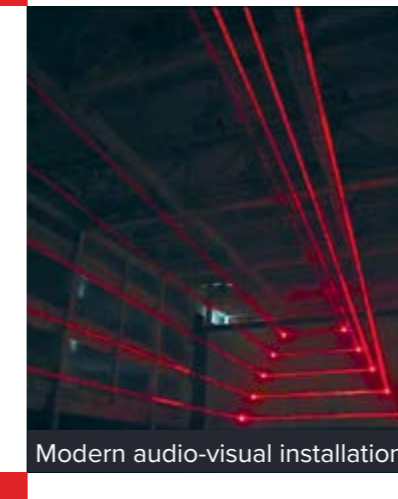

Modern audio-visual installation

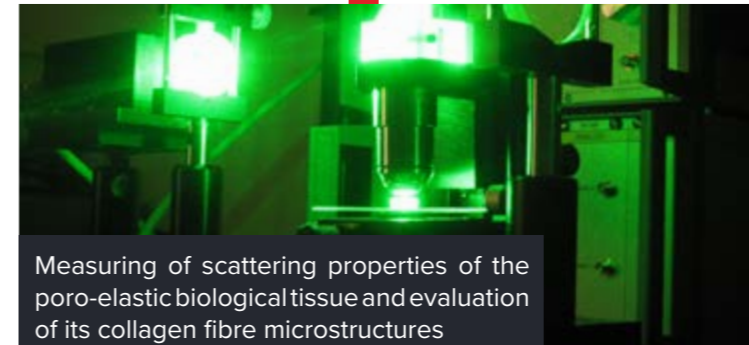

Measuring of scattering properties of the poro-elastic biological tissue and evaluation of its collagen fibre microstructures

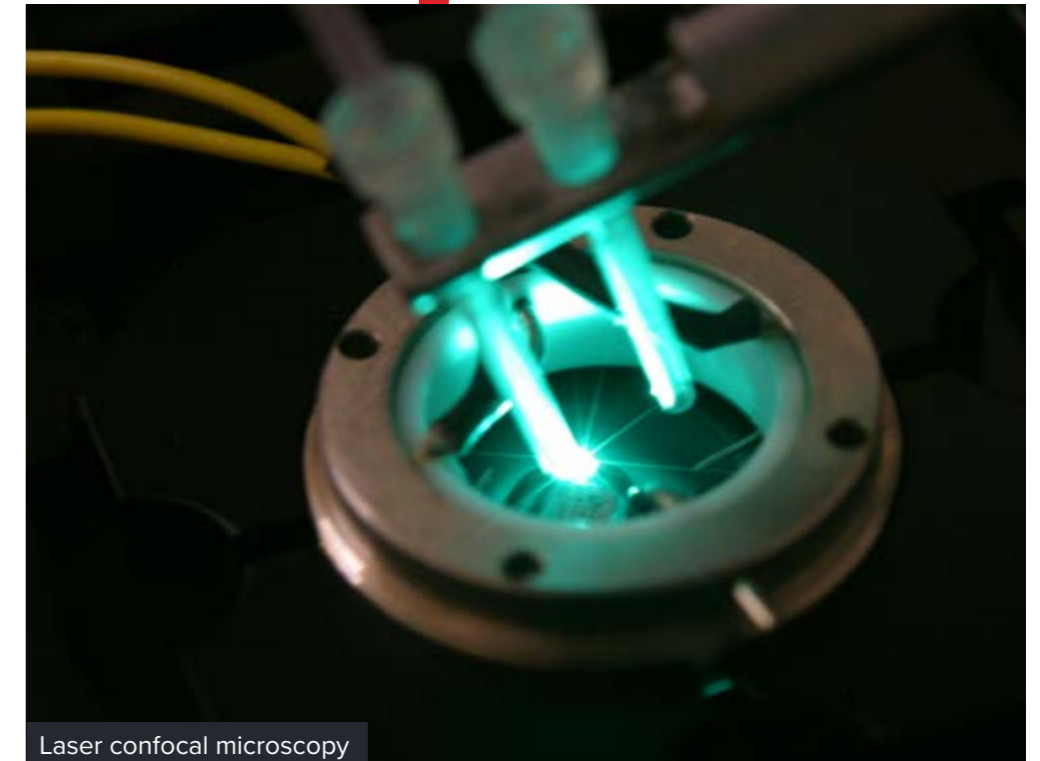

Laser confocal microscopy

Custom Systems

The customisation of laser systems is our strong point.

With or without scanning, single or multi-colour, with beam shaping optics or incredible beam divergence, for creative or scientific applications, extra light or ultra-stable, from hand-held pointers to hundreds of watts, from UV to IR, we are waiting for your enquiries.



Refocusable laser 1W, 905nm, IP65, with red aiming beam



Round low divergence laser beam with homogeneous intensity distribution



Light source with beam detection designed for laser labyrinth



Smallest and lightest high power laser system for graphic projection

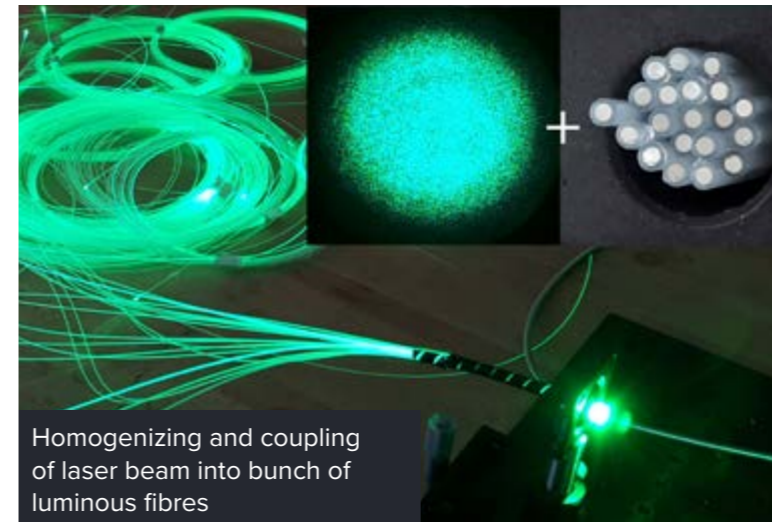

Homogenizing and coupling of laser beam into bunch of luminous fibres

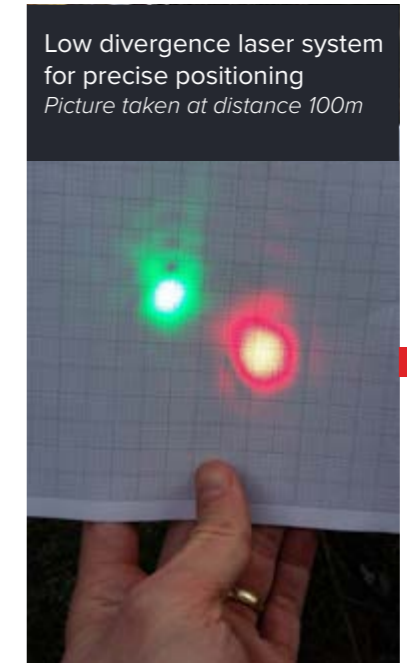

Low divergence laser system for precise positioning
Picture taken at distance 100m



Nd:YAG laser marker for vertical surface engraving



Outdoor low divergence 532nm 20W system for architectural installation

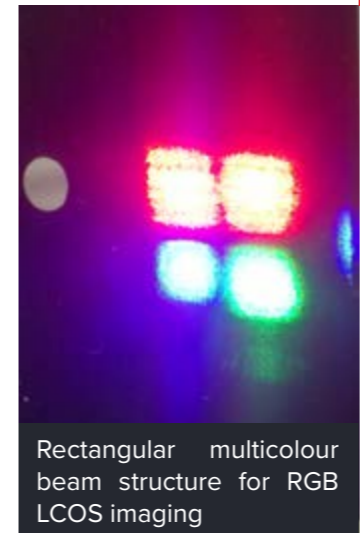

Multimedia laser show system



Compact 4W green laser with steering mirrors for alert signs drawing

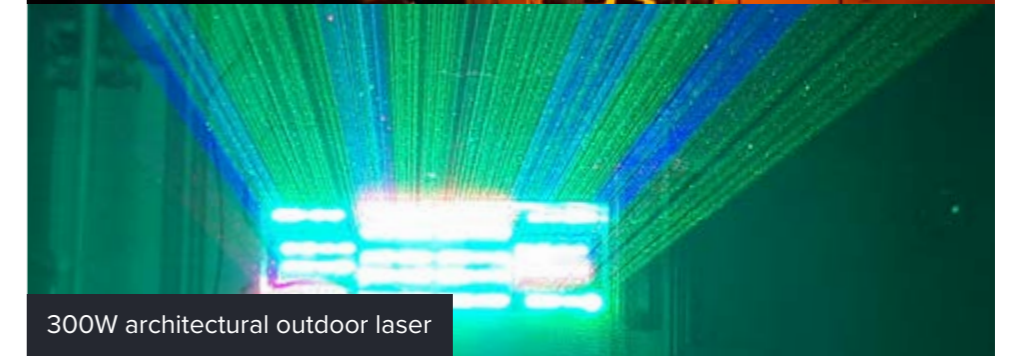

300W architectural outdoor laser

Four color 500mW TEM00 laser system for bio-science with variable beam size (405nm, 488nm, 520nm, 637nm),





Laser modules with heat sink systems, also for outdoor use

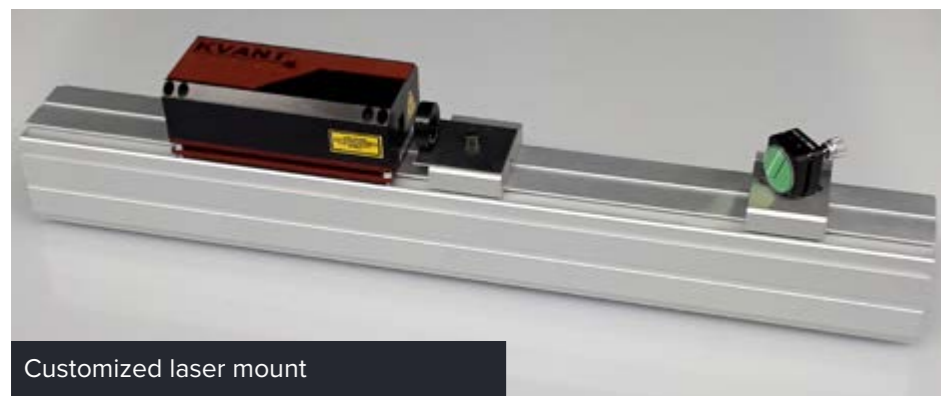

Customized laser mount

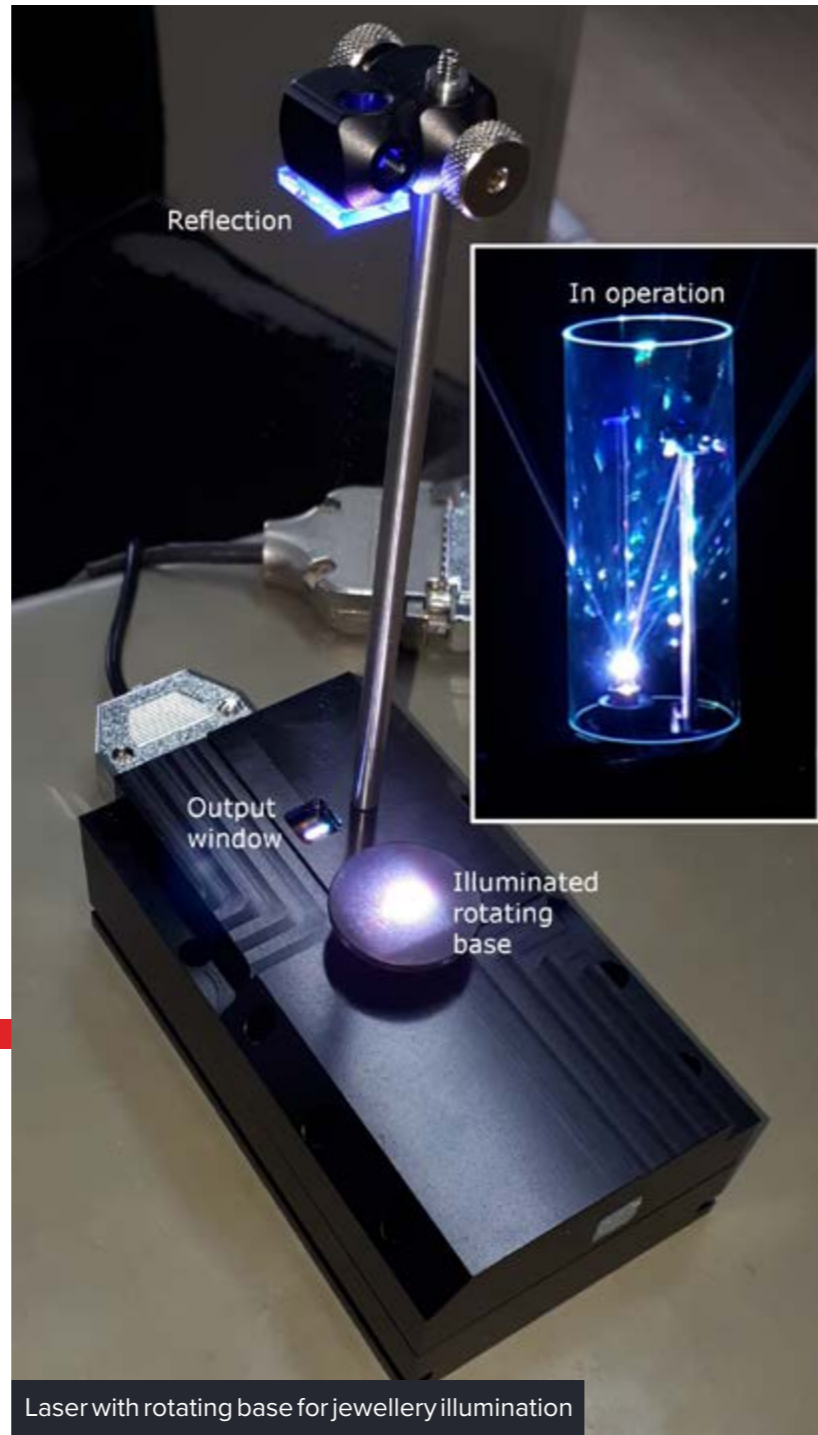

Laser with rotating base for jewellery illumination

Certificates



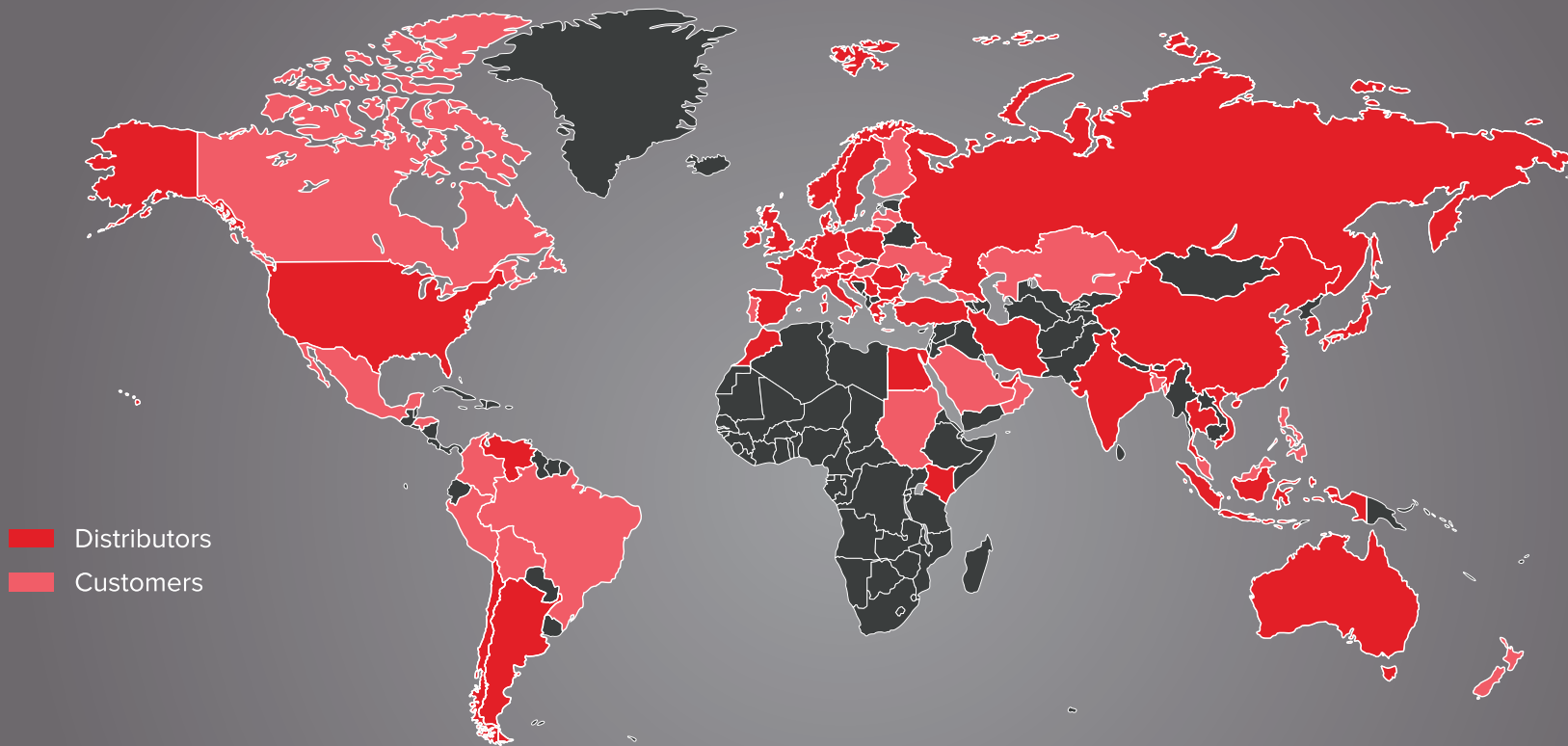

■ Distributors
■ Customers

WWW.KVANTLASERS.SK

Kvant Lasers s.r.o.
Odborárska 23, 831 02 Bratislava
Slovakia, Europe