

IT3-NTG45

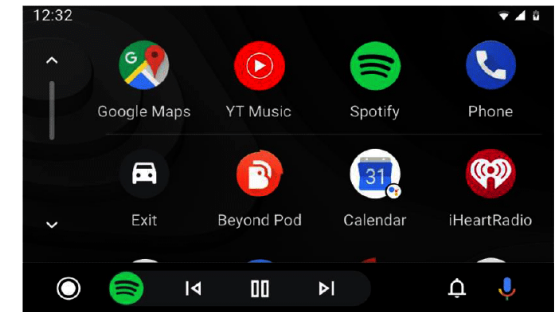

CarPlay / Android Auto + Camera input for Mercedes-Benz vehicles equipped with the NTG4.5 COMAND System

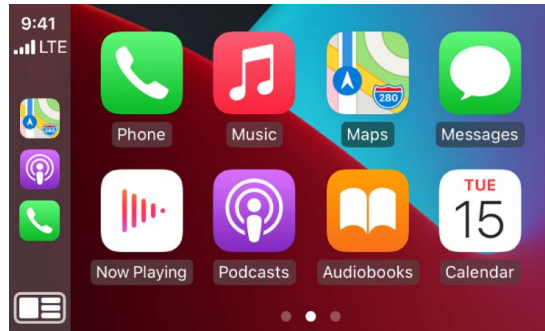

929-220-1212 / 877-241-2526 - www.zz-2.com

Components



ZZPlay Interface

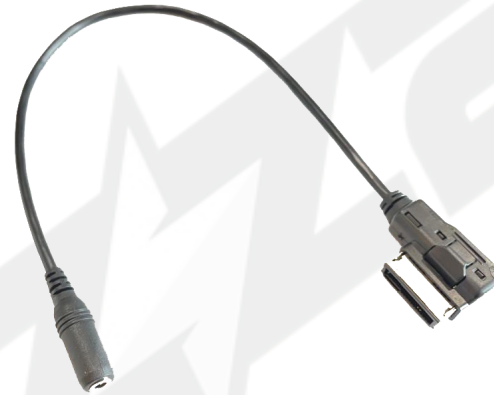

MB AMI Cable



BT/WIFI SMB Antenna



Main Harness



LVDS Y-Cable

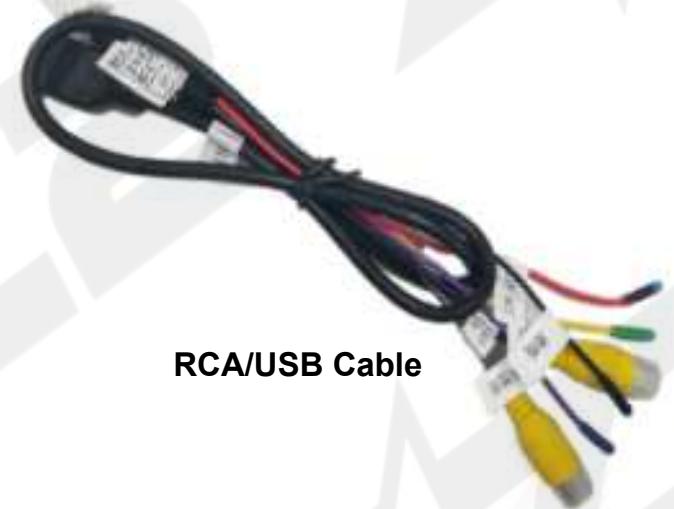

RCA/USB Cable

Connections

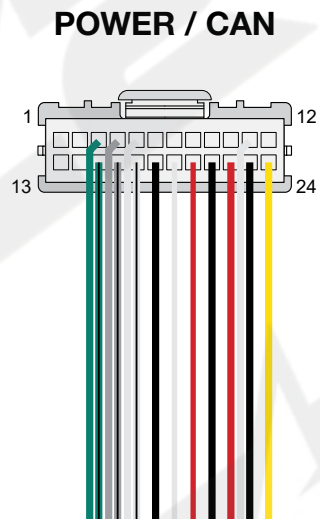
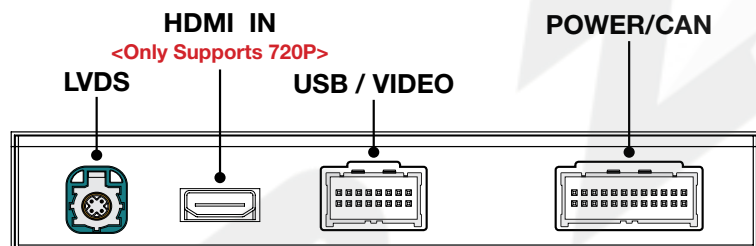

AV CABLE

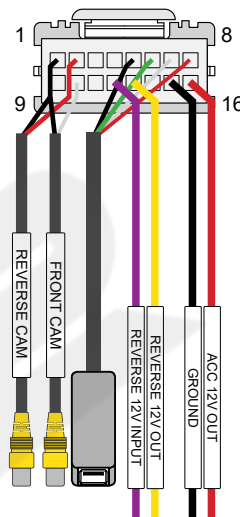

LVDS Cable

The female LVDS connects to the cable that was removed from the radio.

The male LVDS connector goes to the GRAY LVDS connector behind the radio



This plug goes into IT3-NTG45 module

Power / Can Cable			
1	USB1_flag	13	HWCF2_IN_CTL
2	IR_IN	14	BT_RF_C
3	CAN_3_HIGH	15	CAN_3_LOW
4	CAN_2_HIGH	16	CAN_2_LOW
5	CAN_1_HIGH	17	CAN_1_LOW
6	GND	18	GND
7	MIC_IN_N_Car	19	MIC_N
8	MIC_IN_P_Car	20	MIC_P
9	A_R_AMI	21	Audio GND
10	A_L_AMI	22	A_R_AUX_CAR
11	A_L_AUX_CAR	23	GROUND
12	Audio_GND	24	BATTERY POWER INPUT

AV CABLE			
1	CVBS_GROUND	9	
2	REVERSE_CAM_VIDEO_INPUT	10	FRONT_CAM_VIDEO_INPUT
3		11	
4	GROUND_SHIELD	12	REVERSE_12V_INPUT
5	USB_GND	13	REAR_12V_POWER_OUT
6	DATA +	14	
7	DATA -	15	GROUND
8	5V POWER	16	12V(ACC)_OUT



NTG4.5 Installation Diagram

Notes:

- The radio must be in BT Audio or AUX mode for audio playback through the OE speakers.

- *Only ground the 'Audio Ground' if there is NO audio or noise when on AUX from the interface.

- Make certain the OE Fiber-Optic cables are removed from the OE radio plug and moved to the radio side of the T-Harness.

- The AMI-AUX Adapter provided must be connected to the factory AMI (glove box or center console), and the 3.5mm cable must run and connected for interface audio playback.

- If using (violet) reverse wire trigger, 'REVERSE LINE DETECT' must be set to ON in the Reverse setup menu. After this, turn ignition OFF and let car sleep (CAN reset) and test wire trigger.

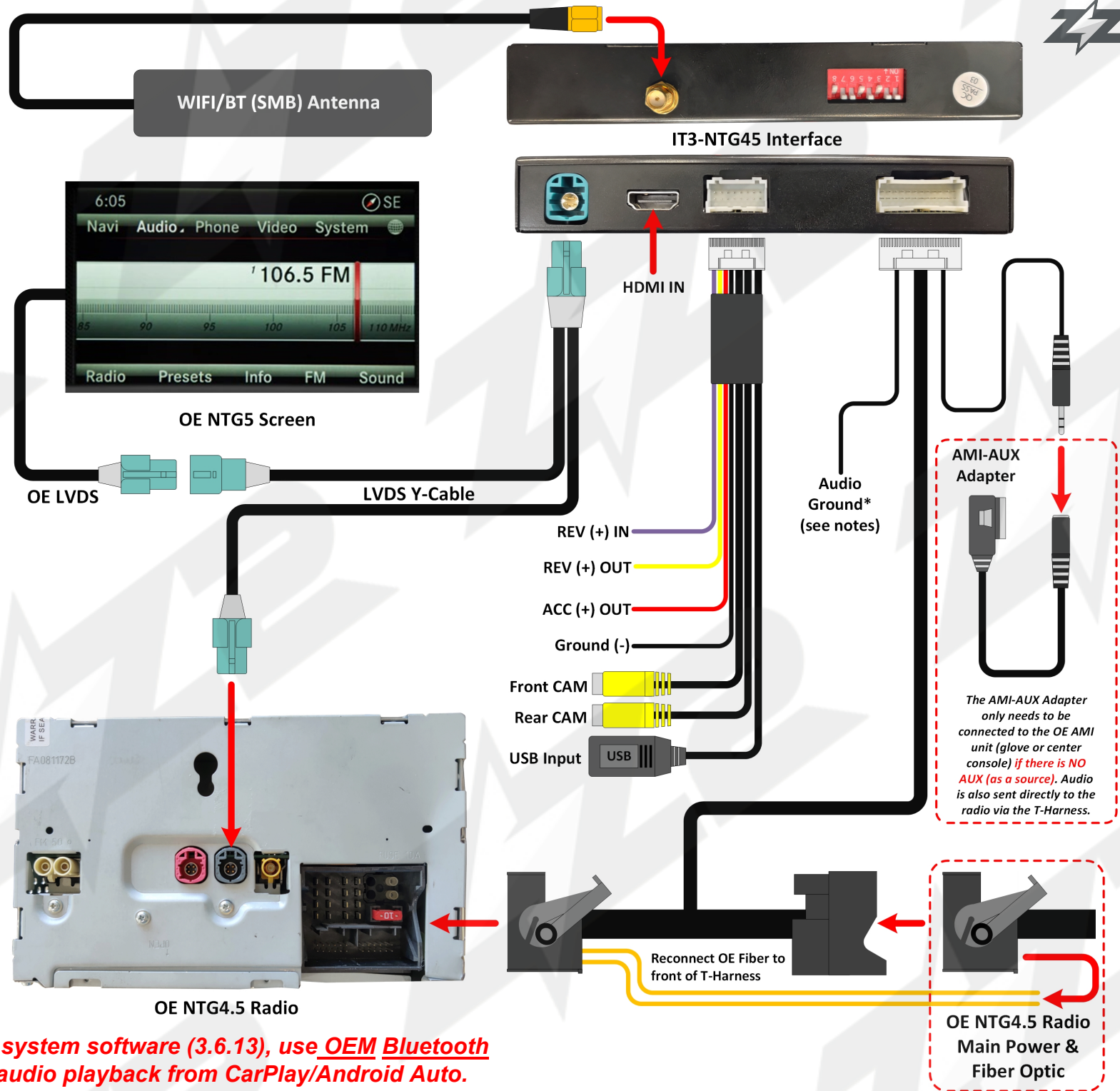

ATTENTION: With the latest system software (3.6.13), use OEM Bluetooth streaming (source) for all audio playback from CarPlay/Android Auto.

DIP Switch Settings



Vehicle	1	2	3	4	5	6	7	8
A-Class 5.8"	OFF (▲) OE MIC	OFF (▲)	ON (▼)	OFF (▲)	ON (▼)	OFF (▲)	OFF (▲)	ON (▼)
B-Class 5.8"								
C-Class 5.8"								
E-Class 5.8"								
GLK 5.8"								
CLA 5.8"								
C, SLK 5.8"	OFF (▲)	ON (▼)	OFF (▲)	ON (▼)	ON (▼)	OFF (▲)	ON (▼)	
E Class 7"	ON (▼) EXT MIC	OFF (▲)	ON (▼)	OFF (▲)	OFF (▲)	ON (▼)	OFF (▲)	ON (▼)
CLS 7"								
GLK 7"								
ML 7"								
G Class 7"								
GL Class 7"								
SLK 7"								

Reset power plug after changing any dip switch setting!

Audio Playback Options



To change these settings, you must access the interface main menu. Go to ZZPLAY>SETUP and scroll towards the bottom of the list. If 'BT Channel' does not exist, your system is out of date and needs to be updated. Contact ZZ2 for more information.

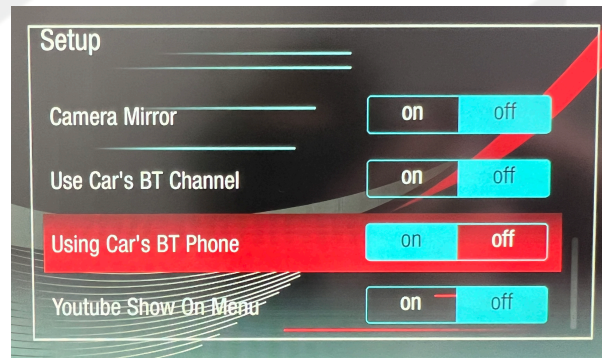

Use Car's BT Channel (ON):
Sends all CarPlay/AA audio (music & telephony) directly to **factory radio's Bluetooth stream source**.

NOTES:

- Not all vehicles will be equipped with Bluetooth streaming - verify before using
- Phone must remain (Bluetooth) connected to the factory radio for phone calls & music
- Use **BT Audio** source (not AUX!) to hear music from CarPlay/AA
- Adjusting this feature (ON or OFF) will reboot the unit once

Use Car's BT Phone (ON): Sends CarPlay/AA **music** to AUX, but **telephony** to factory radio's Bluetooth system for phone calls only.

NOTES:

- Phone must remain (Bluetooth) connected to the factory radio for phone calls only
- Use **AUX Input** source (not Bluetooth Audio!) to hear music from CarPlay/AA
- Answer incoming phone calls **from the steering wheel pickup button** for best results
- Place outgoing phone calls using SIRI/Voice command for best results

Use Car's BT Channel & Phone (OFF): Sends 100% of the audio from CarPlay/AA to the AUX input - including phone calls.

NOTES:

- Connection to factory Bluetooth not required
- May cause echoing during phone calls - MIC settings inside 'AUDIO' section available for adjustment
- Must use this setup for Phone Mirroring feature for sound from phone when mirroring

• How to connect to Apple CarPlay / How to setup Bluetooth Phone Calls



1. If you would like to use a cable to connect your iPhone, please use a certified Apple cable.
2. If you would like to use a wireless connectivity, please follow the next steps.
3. Before pairing the iPhone with the system, please make sure you do a "hard reset" on the phone in order to prevent any malfunction. (Check phone manual/online)
4. Once you are done with the previous step go to Settings > Bluetooth and the phone should be able to find a Bluetooth device called CarPlay8***** under the Other Devices.



4. Select CarPlay8***** and a Bluetooth Pairing Request will be displayed on the screen with a code. Select "PAIR".

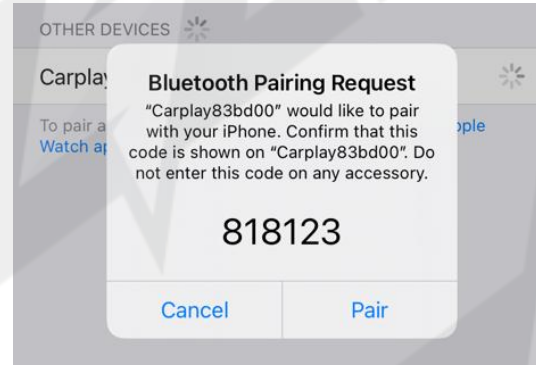

5. Right after the Pairing notification a new request to Sync your contact with the car will be displayed. Select "ALLOW" in order to have caller ID and access to your contacts through CarPlay.

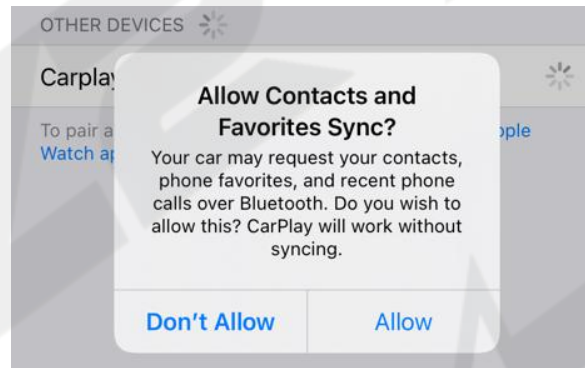

6. A notification asking for a permission to connect your iPhone to the car even when the phone is locked will pop up. Select "Use CarPlay" and the CarPlay main screen should show up on the factory radio screen.

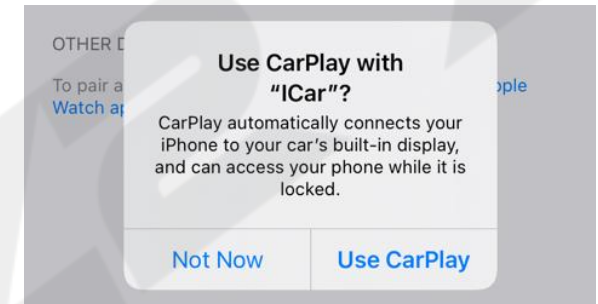

7. When the phone is connected push and hold the STAR (*) button for 2 seconds to switch to CarPlay.

Bluetooth Phone Calls

Please access the Main Menu of the Interface, by selecting the **yellow ZZPLAY tile**, and then go to **SETUP > USING CAR'S BT CHANNEL** and make sure that option is **ON**. After that go back to the main screen and RETURN to CarPlay/Android Auto. **On the phone, please make sure the device is paired with the factory Bluetooth as well as the ZZPLAY unit.**

When using the ZZPLAY system, you must be in Bluetooth Audio source (not AM, FM, AUX or any other source) in order to hear audio from CarPlay/AA. If the vehicle is not factory-equipped with Bluetooth, you must use AUX for the audio source (and BT Channel must be turned OFF).

Activation by original buttons



Steering Wheel Button

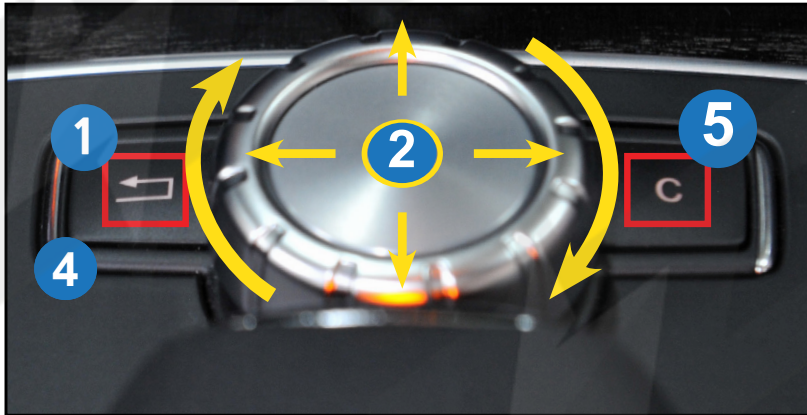
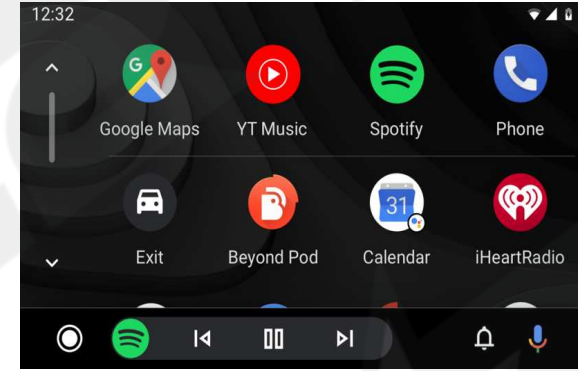
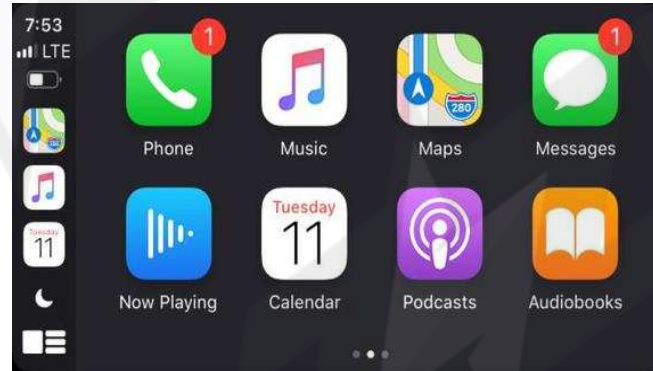

NTG4.5 OEM Buttons

Button	Function	Operation	Remarks
1	Changing Modes	Press the button 3 seconds	Order : OEM → Car Play
		Press the button short time	Return to the OEM mode in any modes.
↕ ↻	Move the pointer Select	Turn the dial	Apple Car Play Function
		Press the dial	Google Android Auto
3	Answer Phone Call	Press the button	Apple Car Play Function Google Android Auto
4	Reset	Press the button 10 seconds	
	Go back	Press the button	
5	Changing Modes	Press the button 3 seconds	Order : OEM → Car Play
		Press the button short time	Return to the OEM mode in any modes.
2	"Siri"	Press the button 5 seconds	Apple Car Play Function
	"Google Assistant"		Google Android Auto

ATTENTION: With the latest system software (3.6.13), use OEM Bluetooth streaming (source) for all audio playback from CarPlay/Android Auto.



Settings <System>



The next few pages overview the IT3 interface, navigating settings and explains entering/ exiting all menus. There are (2) menu systems that exist *outside of the OE radio system*: **CARPLAY (or Android Auto)** menu and the **ZZPLAY Interface Menu**. They operate independent of each other (the ZZPLAY Interface menu will function regardless of whether or not a phone is connected to the module). Settings for CARPLAY will only control CarPlay settings. Settings for the ZZPLAY Interface control things like reverse camera settings, audio output control settings and other vehicle/interface-specific parameters.

Selecting 'Setup' will bring you to the **ZZPLAY Interface Setup Menu** with all options pertaining to the specific vehicle and install.

CARPLAY



ZZPLAY INTERFACE MENU

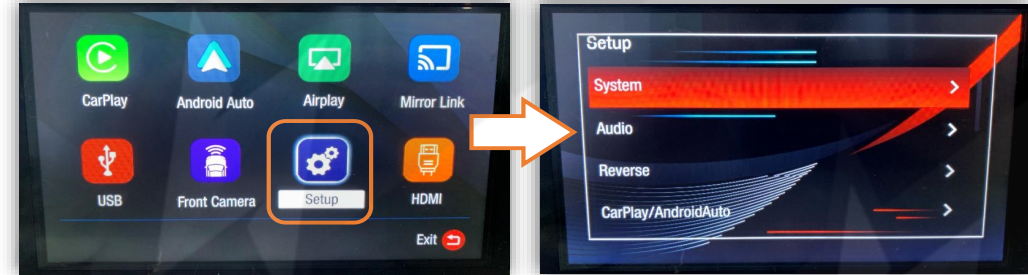

To enter the **ZZPLAY Interface Menu** from the CARPLAY system, locate the 'Exit' tile and select it. If there is no phone connected, simply using the activation button (which normally brings you into CARPLAY mode) will enter you in the **ZZPLAY Interface Menu**.



If a phone is paired and you've entered the **ZZPLAY Interface Menu**, select 'Return to [icon]' to return to CarPlay mode.



Inside **System** includes *Language, Display options, a Software Update prep mode (USB Updates – CONTACT US) and System Version* information for this module. **NOTE: The System Version information screen stores required information when updating the module – take a picture of this if you're planning to update the unit.**

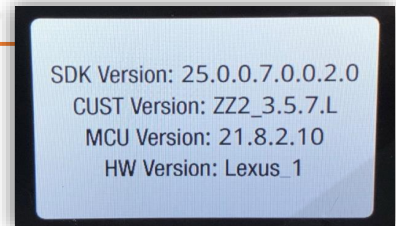

Settings <System>

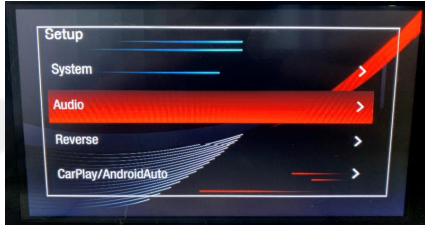

Audio provides audio level controls for the interface: (Global Vol level, Music, Speech and Alert volumes are all separated out specifically for tuning the interface for the best user experience).



An array of **Microphone** settings are used specifically when using the provided system microphone. *ZZ2 recommends using the OEM Bluetooth system whenever possible for IT3 hardware (and in that case, these settings don't apply)*. In some cases where the provided microphone is required, follow these steps to reduce echo delay (OR run 'AEC Auto Setup' below):

Before beginning, be in AUX mode, someone must be on the phone with you (outside of vehicle) to test, start the car and roll all windows up:

1. Bring **Microphone OP (gain)** down as low as possible, to the point where you can still hear them clearly (typically 1-3)
2. Start **Microphone Delay** at 0, bring up 1 detent at a time, testing audibly while you increase this setting (say: 'testing 1, 1, 1, 1', then 'testing 2, 2, 2, 2' as you go, etc). Stop when echo goes away.
3. Re-test the phone call after complete at different (OE) volume levels.

AEC Auto Setup will attempt to run an echo delay test automatically.

For this test you cannot be on the phone to begin with, it uses a series of tones to determine how to adjust settings based on the interior of the vehicle.

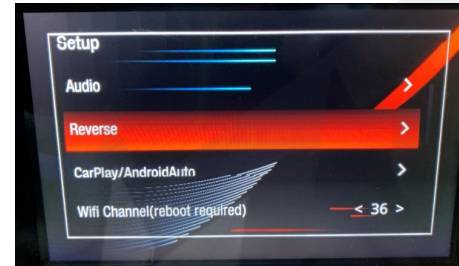
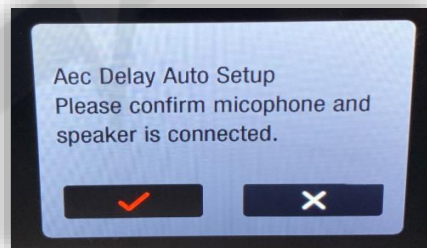

Reverse configures all camera options, whether aftermarket or OEM.

Reverse Camera should be default set to 'Original' for OE camera, or select 'Aftermarket' if adding a reverse camera.

Reverse Line Detect activates the wire trigger (violet) for reverse camera (used for manual transmissions typically), found on the USB Media Harness. With this feature ON, it may also disable the reverse (over CAN data) command. **MUST DO CAN RESET AFTER ADJUSTING THIS SETTING.**

Reverse Display Track designates whether or not to display dynamic guidelines on the reverse image (aftermarket cam only).

Reverse Display Radar is only used when the vehicle is equipped with OE reverse sensors (typically it will show a visual radar screen next to the rear camera image screen).

Front View Time sets the length of time an added front camera (to Front RCA input) will show after leaving reverse gear.

Reverse Match Original adjusts the positioning of reverse screen to match original camera location.

Match 360 Display, or **Ignore 360 State** (vehicle dependent) relates to any vehicle with multiple cameras. Adjust this show those stitched or side cameras when in CarPlay/AA mode not. This feature is typically OFF.



Settings <System>



Carplay/Android Auto has adjustments for the CarPlay screen positioning (overall) and other rarely used CarPlay/AA screen features.

Left Scrap shifts the CarPlay/AA screen to the left in small increments.

Right Scrap shifts the CarPlay/AA screen to the right in small increments.

Top Scrap shifts the CarPlay/AA screen upwards in small increments.

Bottom Scrap shifts the CarPlay/AA screen to the downwards in small increments.

Auto Dark Mode dims the CarPlay/AA screen based on the Phone's current setting (or gets ignored).

Enable Carplay U/D Key changes certain CAN commands, DO NOT USE THIS FEATURE.



Back in Setup, **Wifi Channel (reboot required)** sets the WIFI channel used to connect to the phone. If all other factors have been checked (antenna placement, Low Data Mode off, etc) and you're still having wireless connectivity problems:

1. On the phone, reset phone network settings: **SETTINGS>GENERAL>RESET>RESET NETWORK SETTINGS**
2. On the interface: Set **Wifi Channel (reboot required)** option to '6', then reboot and test.

Wheel Key Swap will adjust the CarPlay/AA navigation controls from UP=UP to UP=DOWN and from LEFT=LEFT to LEFT=RIGHT. **NOTE: this is not supported in every vehicle.**

Touch Pad/Remote Lever (Lexus only):

Mini Touch Pad > For vehicles with TOUCH PAD

Remote Lever > For vehicles with Joystick

Using Car's BT Phone: As of SW version 3.6.13, this setting should no longer be used.

Using Car's BT Channel: As of SW version 3.6.13, this setting should be turned ON for every installation (unless the vehicle does not come equipped with OEM Bluetooth). Once turned ON, use OEM Bluetooth Audio source for all sound from the ZZPLAY unit. This is how ZZ2 always suggests to use these systems

HiCar map confirmation: This setting is never used in N.A. – leave OFF and ignore.

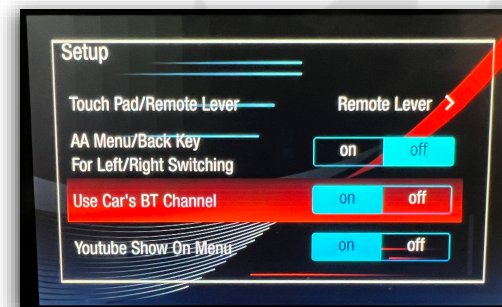

IT3-NTG45 **FAQ**



Question: *I can't hear any audio from the CarPlay/Android Auto system.*

Answer: Your OE system must be resting on BT Audio (if on latest module sw) or AUX mode in order to hear any sound from the kit. This includes during phone calls.

NOTE: Some systems AUX input are not labeled 'AUX', it may be labeled 'Media Interface' or there may be an audio conversion to the vehicle's USB input. Check with your installer for more information.

Question: *I'm hearing reports of a lot of echo or delayed echo on audio during a phone call. Why is this happening and how can I eliminate this?*

Answer: This happens when using the OEM AUX input for audio instead of the OEM Bluetooth. When using AUX, the signal path travels through the OEM amplifier, and there is active time-alignment & processing on this audio channel which is the root cause. To avoid this problem, the module must have the latest firmware update (at least 3.6.13), and then inside ZZPLAY setup, turn on 'Using Car's BT Channel'. With this setting active, use factory Bluetooth Audio instead of AUX for all sound from CarPlay/AA.

Question: *Sometimes my phone won't connect lately / Sometimes when it connects the screen goes black / Sometimes CarPlay kicks me out back to the interface menu.*

Answer: For iPhone users, you must perform a 'Hard Reset' on the phone in use on average twice a month to clear certain cache and reset the processors (this will not wipe any data). Google search 'Hard Reset iPhone 13' (or whatever version iPhone version you have) and perform that task. After this is done properly, you will see a difference in speed and reliability (of pairing/connecting).

Question: *Incoming text responses from SIRI are silent on CarPlay. It mutes the audio but I don't hear the read-out.*

- **Fix 1:** Try a Forced Restart (hard reset, above)
- **Fix 2:** Disconnect from CarPlay (may require forgetting the unit entirely).. remain connected to the OEM Bluetooth source. Active SIRI from the phone - while SIRI is responding, turn the volume UP using the phone volume keys as high as required.

Question: *Using Android, I cannot get the phone to reliably connect wirelessly (or at all).*

Answer: Android phones are more finicky and iPhones with their wireless connectivity. Make sure the OS is fully up-to-date. Clear the cache on the Android Auto application. The Android OS must be at least version 11. Some phones (TCL, Motorola) seem to have protocols that don't play nice with every system. If you run into this, use a good USB-C cable for the Android Auto Connection instead.



support@zz-2.com

929-220-1212

Toll free: 877-241-2526

Extension 2: Tech Support

Agreement: End user agrees to use this product in compliance with all State and Federal laws. ZZDOIS LLC dba ZZ-2 is not to be held liable for misuse of its product. If you do not agree, please discontinue use immediately and return product to retailer. This product is intended for off-road use and passenger entertainment only.

Before installation of any ZZ-2 LLC products, users must fully read and understand the manual. By installing and/or using the product you agree to be bound by the following terms and conditions: *In no respect shall ZZ-2 LLC incur any liability for any damages, including, but limited to, direct, indirect, special, or consequential damages arising out of, resulting from, or any way connected to the use of ZZ-2 LLC products whether or not based upon warranty, contract, tort, or otherwise; whether or not injury was sustained by persons or property or otherwise; and whether or not loss was sustained from, or arose out of, the results of, the item, or any services that may be provided by ZZ-2 LLC.*