

Outdoor Alarm Controller 2

YS7107-UC & Siren Horn

Quick Start Guide

Revision Apr. 17, 2023

A Welcome!

Thank you for purchasing YoLink products! We appreciate you trusting YoLink for your smart home & automation needs. Your 100% satisfaction is our goal. If you experience any problems with your installation, with our products or if you have any questions that this manual does not answer, please contact us right away. See the Contact Us section for more info.

Thank you!
Eric Vanzo
Customer Experience Manager

The following icons are used in this guide to convey specific types of information:

- Very important information (can save you time!)
- Good to know info but may not apply to you

- Pour des instructions en français, scannez les codes QR dans la section suivante.
- Para obtener instrucciones en español, escanee los códigos QR en la siguiente sección.

B Before You Begin

Please note: this is a quick start guide, intended to get you started on the installation of your Outdoor Alarm Controller 2 and Siren. Download the full Installation & User Guide by scanning this QR code:



You can also find all current guides and additional resources, such as videos and troubleshooting instructions, on the Outdoor Alarm Controller 2 and Siren Product Support Page by scanning the QR code below or by visiting:

<https://shop.yosmart.com/pages/outdoor-alarm-controller-2-product-support>



Your Outdoor Alarm Controller 2 connects to the internet via a YoLink hub (SpeakerHub or the original YoLink Hub), and it does not connect directly to your WiFi or local network. In order for remote access to the device from the app, and for full functionality, a hub is required. This guide assumes the YoLink app has been installed on your smart-phone, and a YoLink hub is installed and online (or your location, apartment, condo, etcetera, is already served by a YoLink wireless network).



The Outdoor Alarm Controller is capable of supplying 12VDC power to devices for limited periods of time. The device must have a current draw, including momentary inrush current, less than 400 mA.

C In the Kit

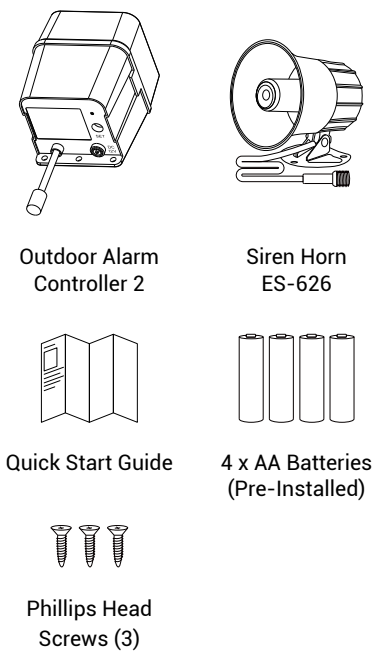

D Required Items

These tools or items may be required:

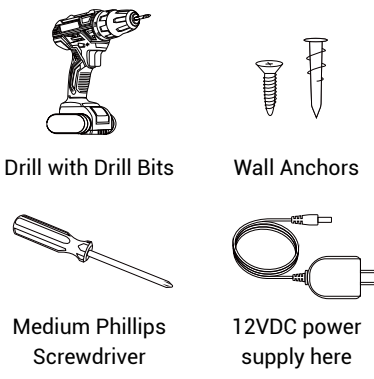

E Get to Know Your Outdoor Alarm Controller 2

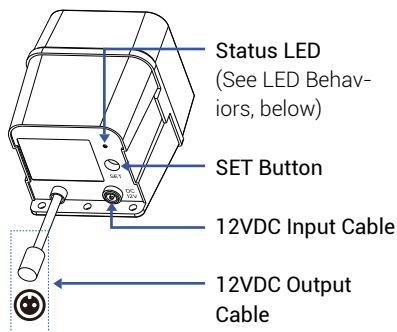

E Get to Know Your Outdoor Alarm Controller 2, Cont.

- ### LED Behaviors
- Blinking Red Once, Then Green Once
Device Start-Up
 - Blinking Red And Green Alternately
Restoring to Factory Defaults
 - Slow Blinking Green
Updating
 - Fast Blinking Green
Control-D2D Pairing in Progress
 - Steady Green
DC power is applied
 - Blinking Red Once
Siren or Output Activated (on battery power)
 - Blinking Red Continuously
Siren or Output Activated (on external power)
 - Fast Blinking Red
Control-D2D Unpairing in Progress
 - Fast Blinking Red Once Every 30 Seconds
Low Battery, Replace Battery Soon

F Get to Know Your Siren

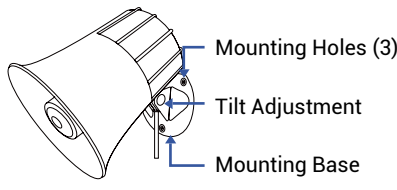

G Power Up

Press the SET button briefly, long enough for the LED to illuminate, blinking red then green.



The Outdoor Alarm Controller 2 is optimized for standard alkaline batteries. Lithium batteries may be used, but the battery level may not be correctly indicated in the app. False low-battery indications may occur.

Do NOT use rechargeable batteries!

H Add Your Outdoor Alarm Controller 2 to the App

1. Tap **Add Device** (if shown) or tap the scanner icon:

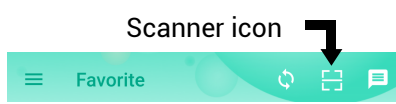

2. Approve access to your phone's camera, if requested. A viewfinder will be shown on the app.

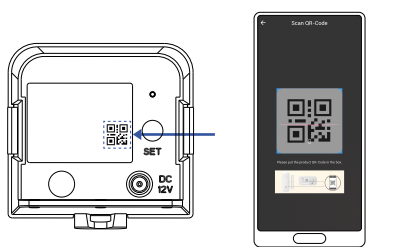

3. Hold the phone over the QR code so that the code appears in the viewfinder. If successful, the **Add Device** screen will be displayed.

You can change the device name and assign it to a room later. Tap **Bind device**.

If successful, the message "You have successfully added this product!" will be displayed. Tap **Done**.

4. Confirm the Outdoor Alarm Controller 2 is noted as being online before proceeding to the next section. If not, double-check the steps in the Power Up section.

I Installation

Preparing for Installation

Determine where you will install your Outdoor Alarm Controller 2 and Siren. Typically, they will be mounted together, no farther apart from each other than the cables allow. (Extension cables are available, allowing for locating the siren remotely from the controller)

Note: use of the 12VDC power adapter is optional. If not used, batteries are required. If the power adapter is used, batteries are optional.

Determine how you will mount the controller and siren, and have appropriate mounting hardware (screws, anchors, etc.) and a means of installing them in the wall or mounting surface on hand.

It is important to securely mount the Outdoor Alarm Controller and the Siren to the wall or mounting surface, to ensure they do not later fall down. Physical damage to the device is not covered by the warranty.

Consider if the controller or siren will be subjected to tampering or vandalism. Mounting them higher on the wall may deter tampering.

Also, consider minimum mounting heights. As the siren is very loud, you should avoid locating it near head height or at locations where people may be present when it activates. Hearing can be damaged by high decibel sounds, such as the siren produces.

While the controller and siren are designed for outdoor use, as with any electronic or similar device, protecting it from direct intense sunlight and from rain or snow with overhead cover, can extend its life and protect it from issues like fading colors or dry and brittle cables or plastic. Just under the eaves of a roof or under an overhanging structure is an ideal location for this product.

Pro tip: like the professional installers may do, you can consider installing your siren in the attic, if applicable. A location in the attic may allow for sound to be carried both inside the home as well as outside (depending on siren proximity to eaves or gable vents and the construction characteristics of your home).

You may consider testing the siren at the proposed location before permanently installing it, checking that the sound carries as far as desired.

Additional Alarm Controllers and Sirens can be added to your system, and may be required for larger homes or buildings, and larger yards or locations with sound obstructions and/or high ambient sound levels.



If you are using the Outdoor Alarm Controller 2 with a 12V DC device other than the included siren, such as a strobe or relay, please note the following:

- The device must be 12V DC, not AC, not less or more than 12 volts.
- The device current draw and inrush current must be under 400 milliamps.
- Correct polarity must be observed.
- Do not attempt to power the device for extended periods, as this will quickly drain the battery.
- Consider using the controller to power a low-current 12VDC relay or mechanically-latching relay, with the load being powered by a separate power source.
- If splicing the cable to another cable or device, use care to not damage the antenna wire, which is attached to the controller cable!

Install the Siren

1. Holding the siren at the desired location, transfer the location of the three mounting holes to the wall or mounting surface, using a marker or similar means.

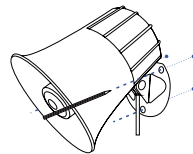

2. If you are using wall anchors, install them per the manufacturer instructions (this may require a drill and appropriate drill bit).

3. Secure the siren base to the wall or mounting surface, with three screws. Check that it is securely-mounted, by gently tugging on it.

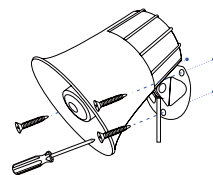

4. You can adjust the desired up/down tilt of the siren at this time or during testing.

Install the Outdoor Alarm Controller 2

1. At the desired location for the controller, confirm the cables of the two devices will reach each other. Holding the controller at the desired location, mark the location of the mounting holes to the wall or mounting surface, using a marker or similar means.

2. If you are using wall anchors, install it per the manufacturer instructions.

3. Secure the Alarm Controller to the wall or mounting surface with a screw, as shown.

J Final Connections & Testing

1. Connect the cable of the controller to the cable of the siren. Ensure the arrow of the cable connector aligns with the arrow of the other cable connector. Twist the collar of the connector tight.

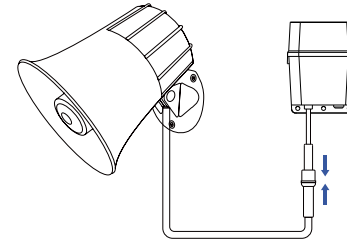

2. If using an external 12V DC power supply, connect the cable to the controller at this time. With the power source off or unplugged, connect the cable of the 12V DC power adapter or power supply to the 12V DC input of the alarm controller.

3. If applicable, turn on the 12V DC power supply or connect the power adapter to AC power at this time.

4. Test the siren by pressing the SET button on the controller. The siren should activate. Press the SET button again to silence the siren.



Protect your ears and those of others that may be close to the siren during testing. Consider warning your neighbors you will be testing your siren, to avoid a surprise visit from the police department!

Refer to the full installation and user guide to complete the setup of your Outdoor Alarm Controller 2 and Siren.

K Contact Us

We are here for you, if you ever need any assistance installing, setting up or using a YoLink app or product!

Need help? For fastest service, please email us 24/7 at service@yosmart.com

Or call us at **831-292-4831** (US phone support hours: **Monday - Friday, 9AM to 5PM Pacific**)

You can also find additional support and ways to contact us at: www.yosmart.com/support-and-service

Or scan the QR code:



Support
Home Page

Finally, if you have any feedback or suggestions for us, please email us at feedback@yosmart.com

Thank you for trusting YoLink!

Eric Vanzo
Customer Experience Manager

YOLINK

15375 Barranca Parkway
Ste. J-107 | Irvine, California 92618

© 2023 YOSMART, INC IRVINE,
CALIFORNIA