



AC4000 MU-MIMO Tri-Band Wi-Fi Router

Superior Processing Power
Ultimate Tri-Band Performance



Archer C4000



1625 Mbps + 1625 Mbps
+ 750 Mbps Tri-Band



1.8 GHz
64-bit CPU



MU-MIMO



Airtime
Fairness



RangeBoost

Highlights

Tri-Band for Multiple Connections

With one 2.4 GHz and two 5 GHz bands, the Archer C4000 keeps all your devices connected without slowing down your network. Now, you can game and stream in 4K on multiple devices at the same time.

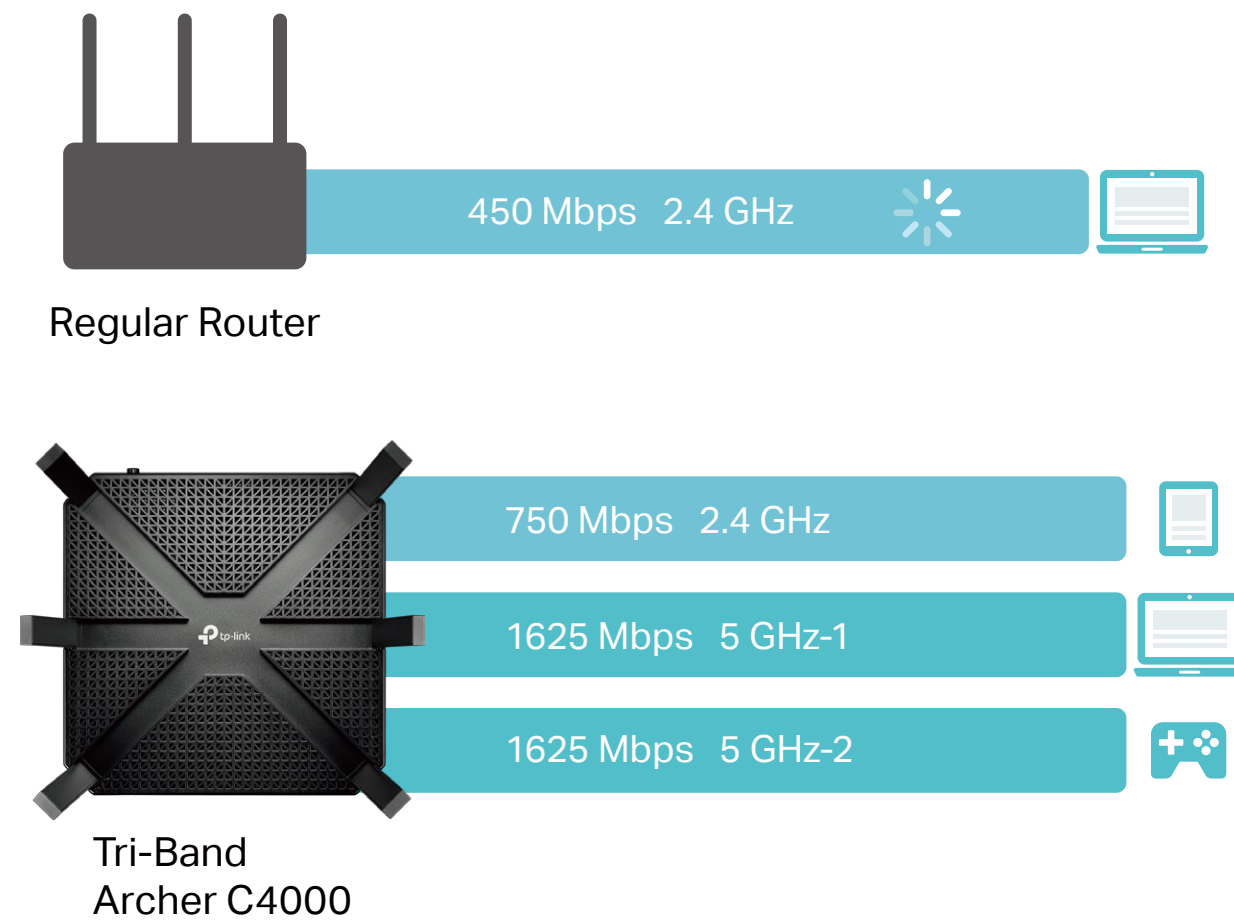

Powerful 1.8 GHz 64-bit CPU

The powerful 1.8 GHz 64-bit CPU, three co-processors and 512 MB of RAM work together to power your network.

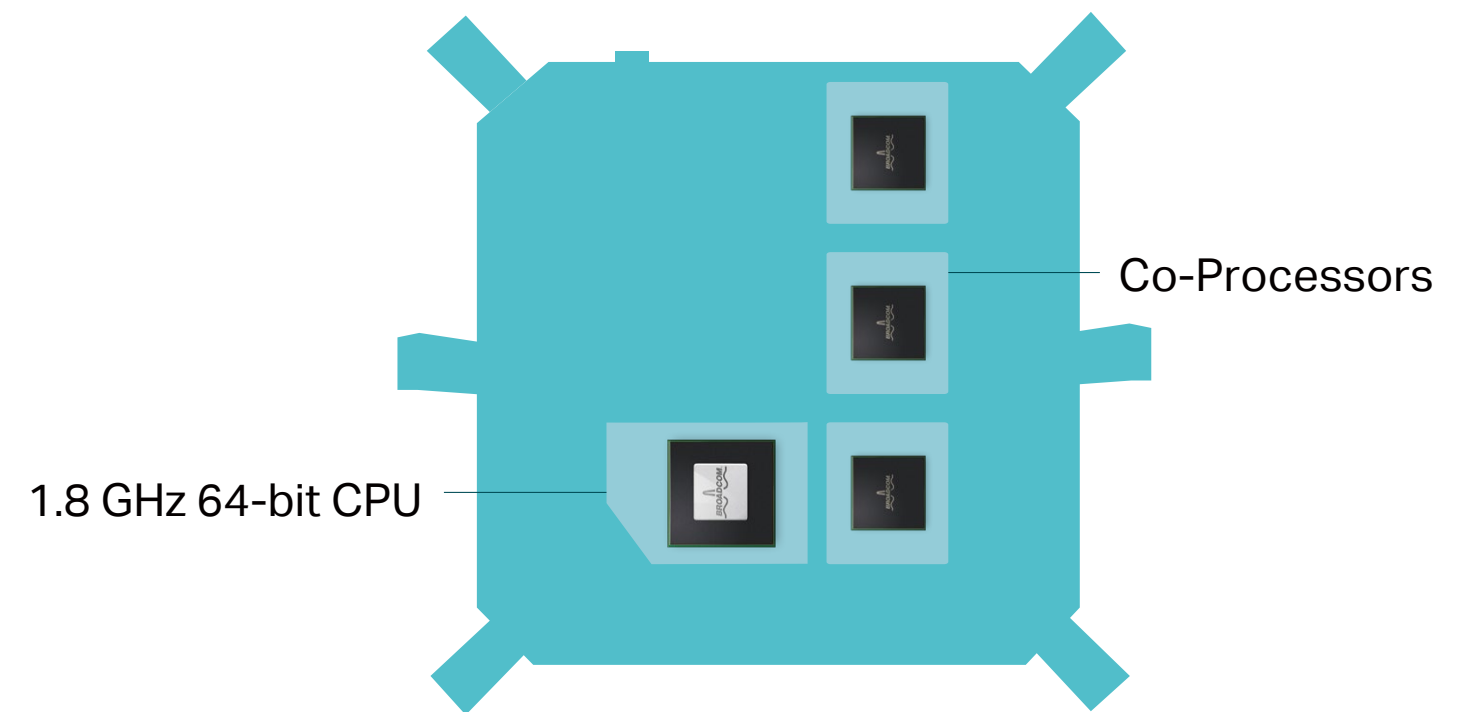

Highlights

MU-MIMO for Multiple Connections

MU-MIMO technology serves up to multiple devices at once, reducing wait time, increasing Wi-Fi throughput for every device and making each stream more efficient.

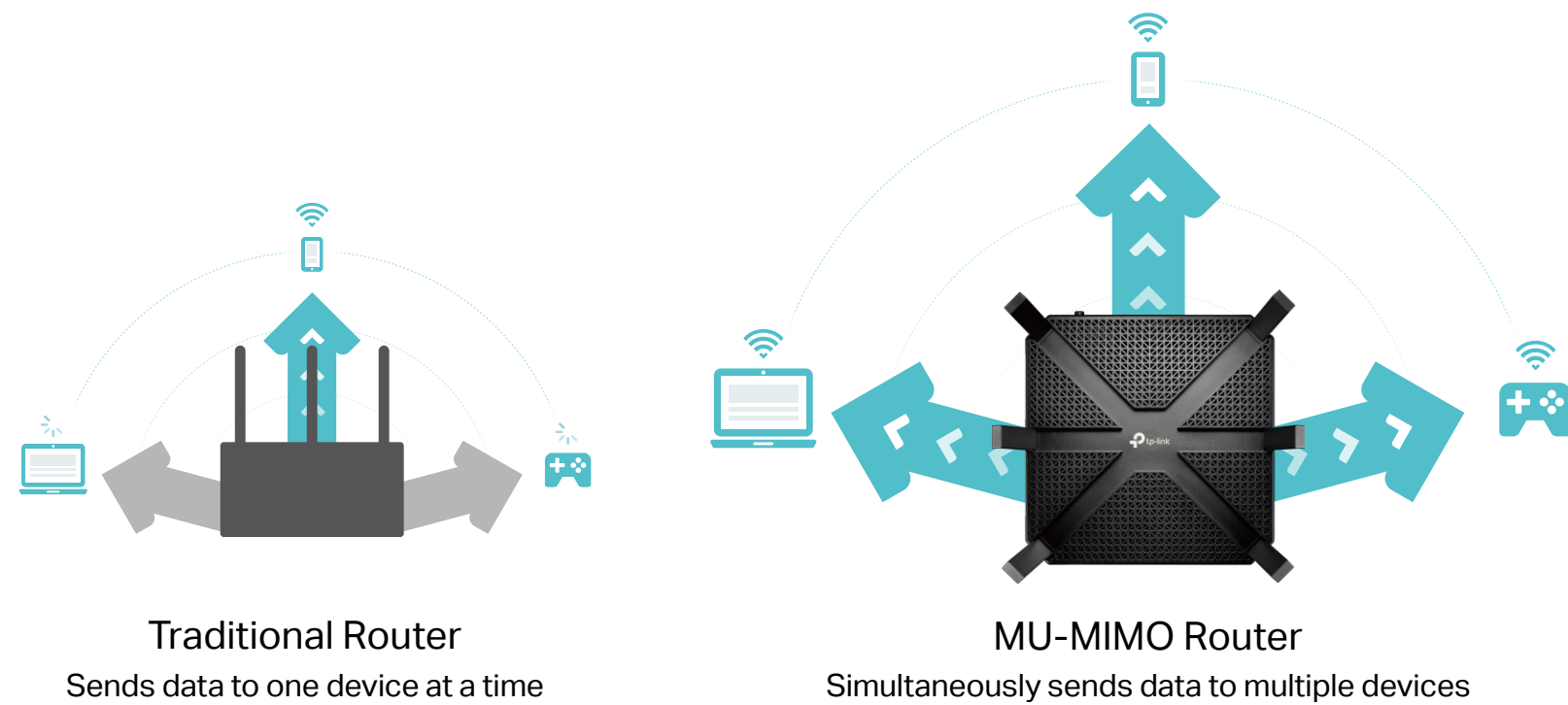

Far-Reaching Wi-Fi Coverage

RangeBoost greatly improves the ability of the router to detect devices that are further away or low-powered while Beamforming boosts wireless signal strength toward them, giving your network even greater coverage.

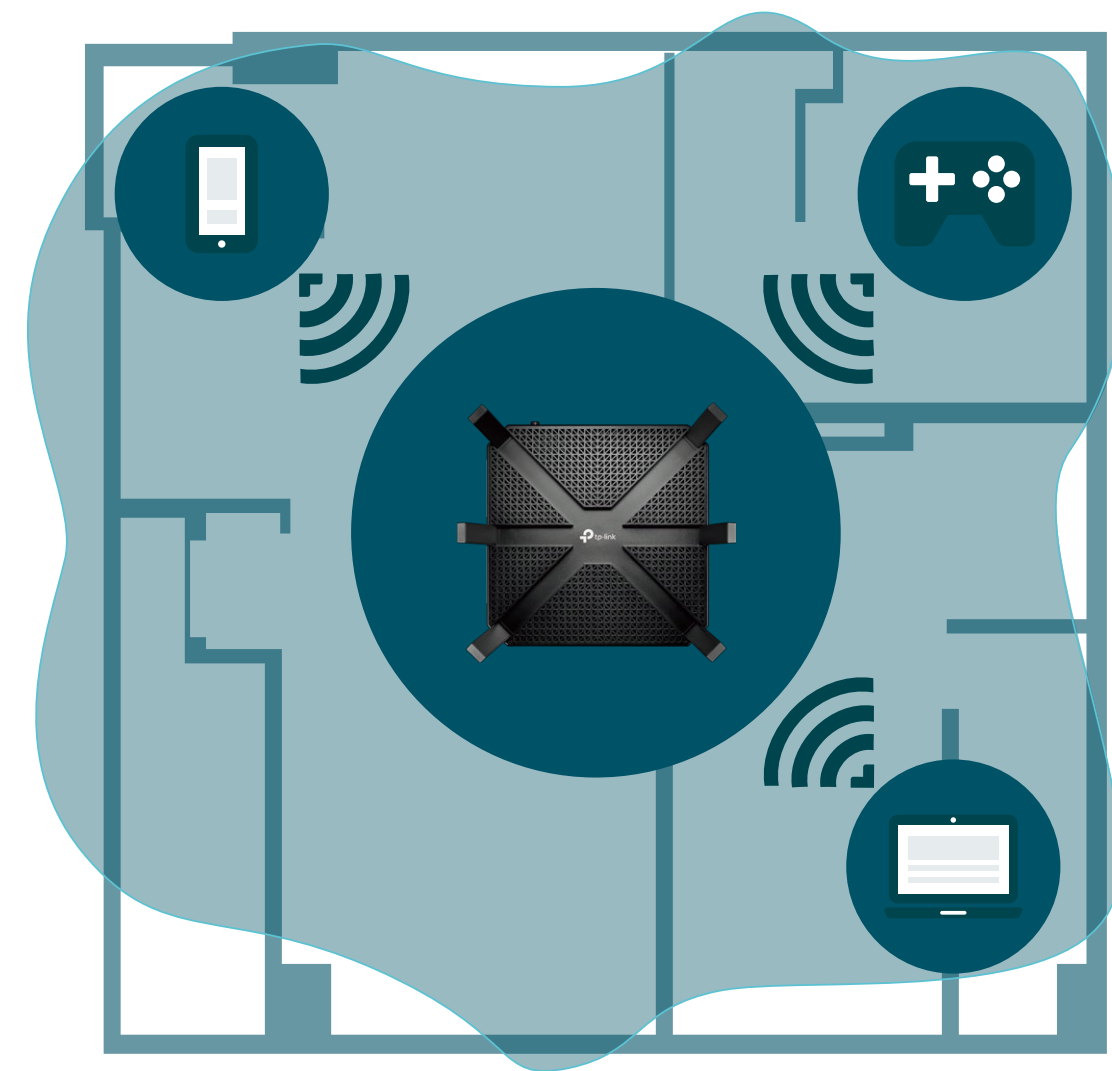

Highlights

Smart Connect for Efficient Performance

Intelligently selects the best available Wi-Fi band for each device to keep connection at top-speed—without worry of weak or dropped connections.

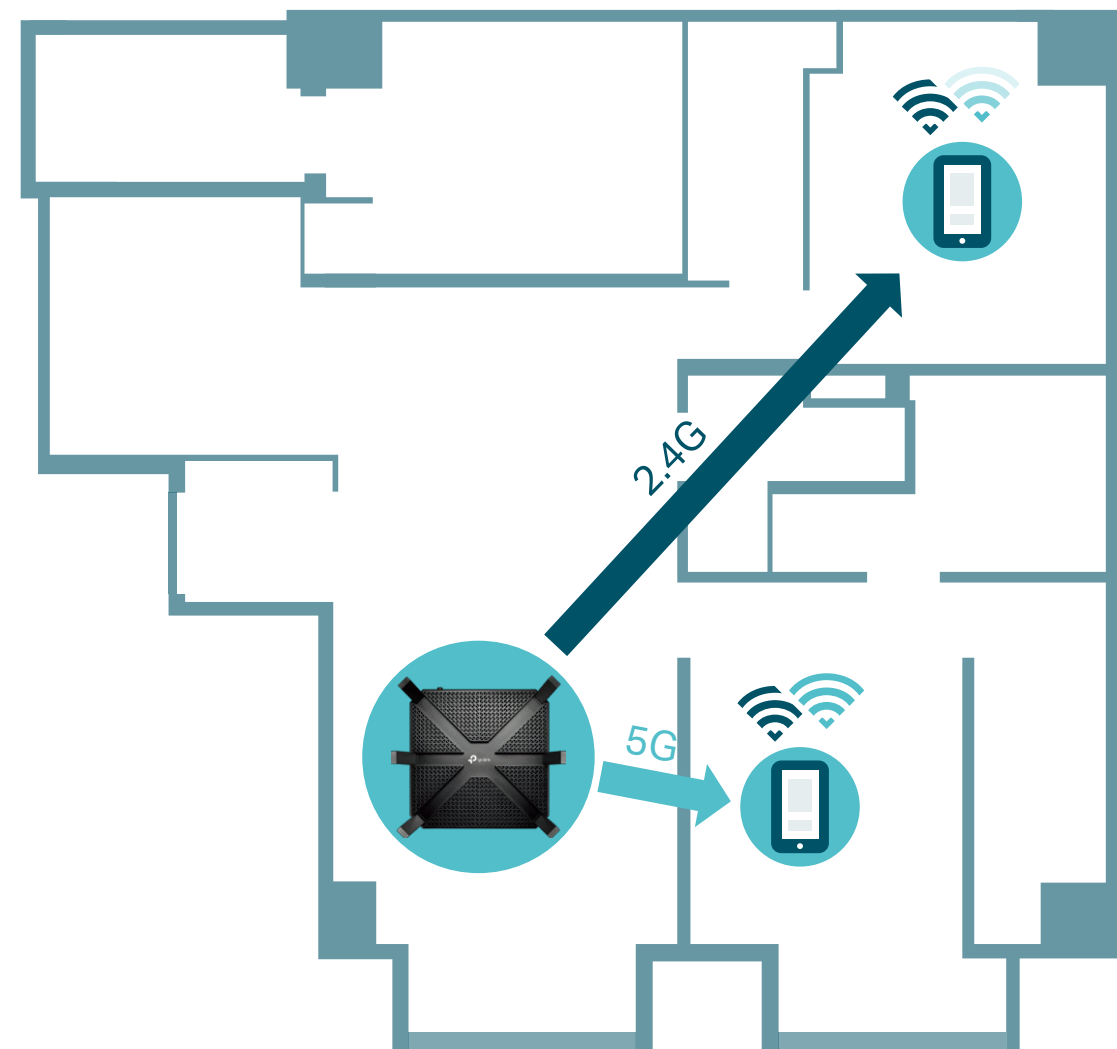

Airtime Fairness

Equally divides attention between new devices like your gaming rig and older devices to improve Wi-Fi performance and reliability without limiting your network.

Normal Time

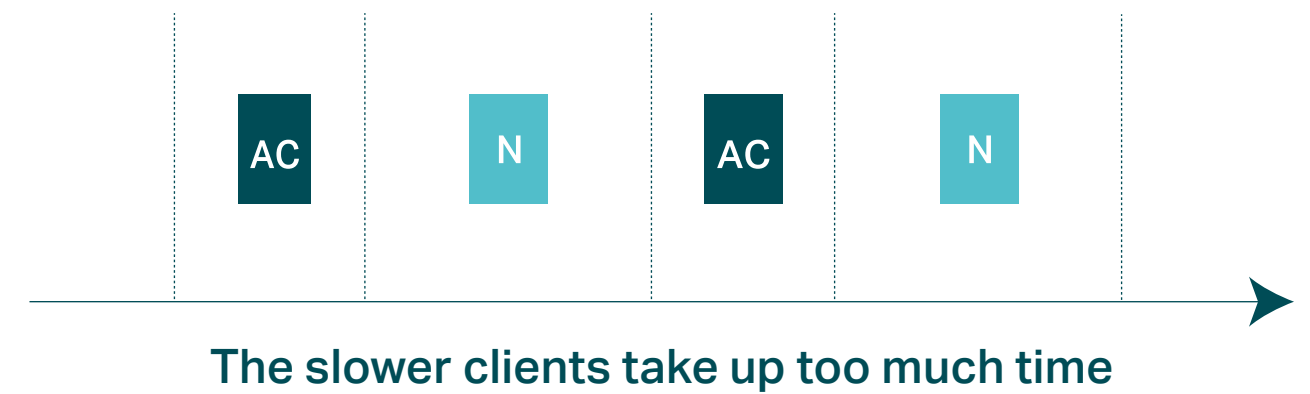

Airtime Fairness Time



Highlights

High-Speed Transmission Powered by Link Aggregation

Link aggregation accelerates data transfer to network-attached storage (NAS) devices by combining two separate Ethernet ports into a 2 Gbps connection.

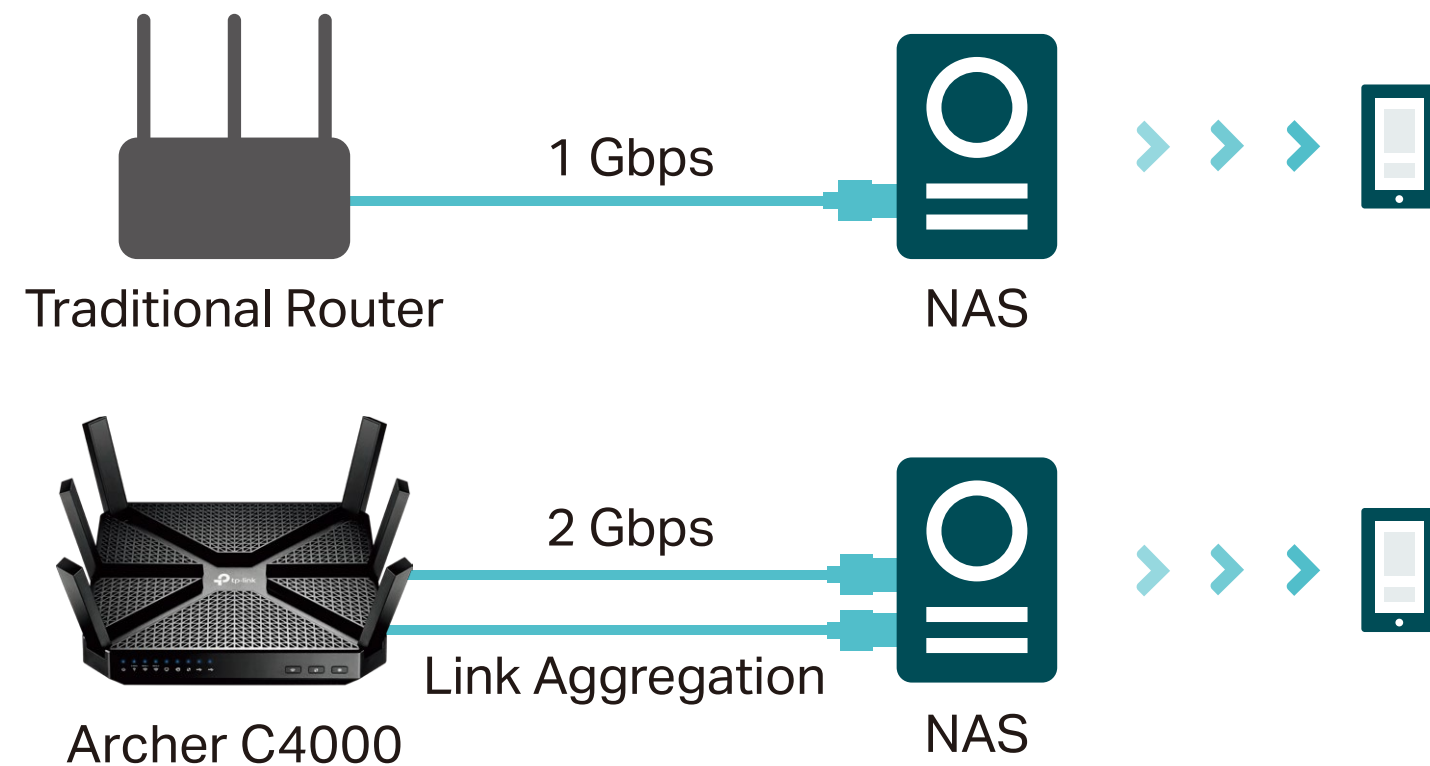

HomeCare™ for the Most Comprehensive Home Wi-Fi Security

Create a customized and more secure Wi-Fi network with TP-Link HomeCare™. Antivirus, Parental Controls and QoS powered by Trend Micro® give you the tools you need to fully manage your network.

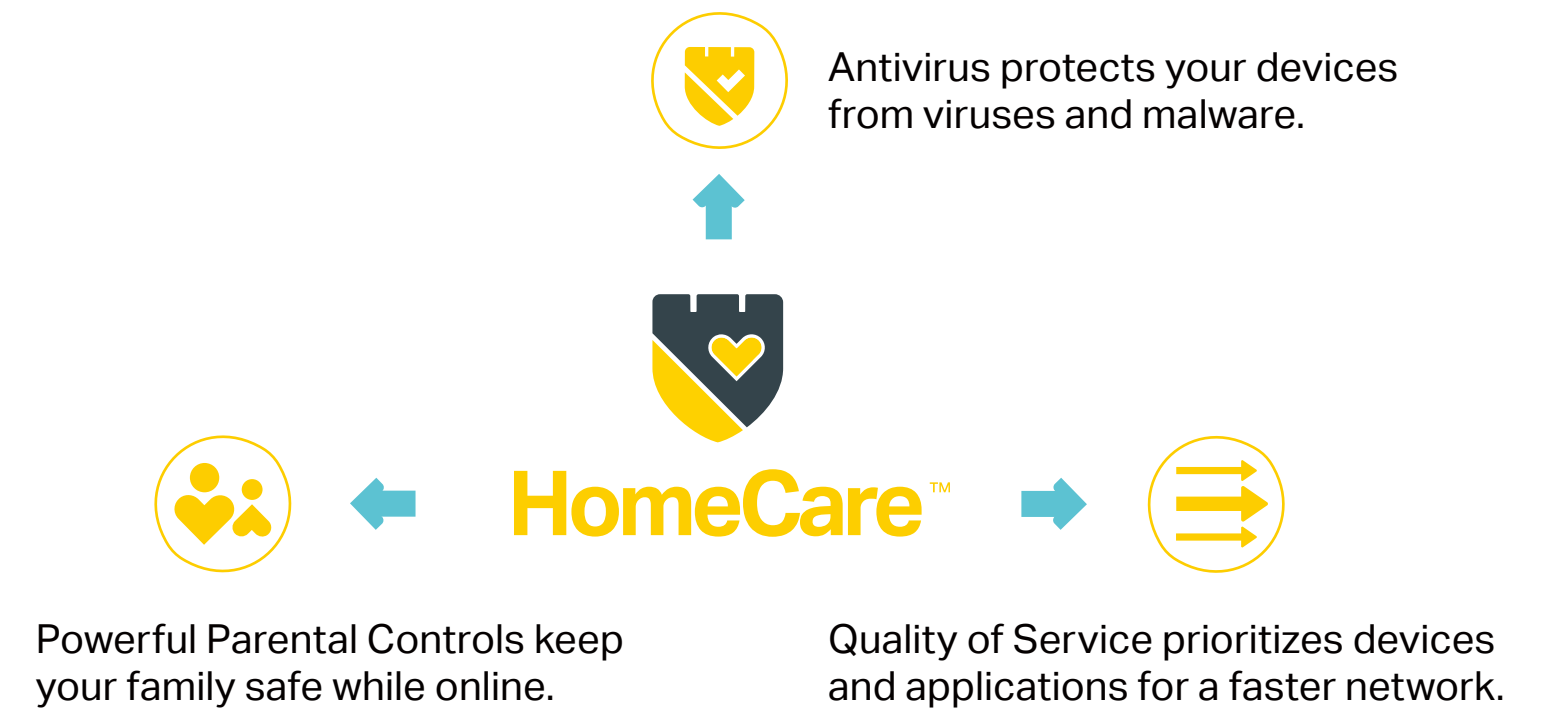

Features



Speed

- **Ultimate Wireless Speed** – Wireless speeds up to 1625 Mbps on 5 GHz-1, 1625 Mbps on 5 GHz-2, and 750 Mbps on 2.4 GHz
- **NitroQAM Technology** – Uses NitroQAM (1024- QAM) modulation scheme for higher data throughput, boosting wireless speeds by up to 25%
- **MU-MIMO Technology** – Simultaneously exchanges data with several devices, achieving speeds which are 3x faster than standard AC routers
- **Support 802.11 ac** – Provides a data transfer rate 3 times faster than 802.11n for each stream
- **1.8 GHz CPU** – 1.8 GHz 64-bit CPU and 3 co-processors make multi-tasking easy and boost data transfer rate

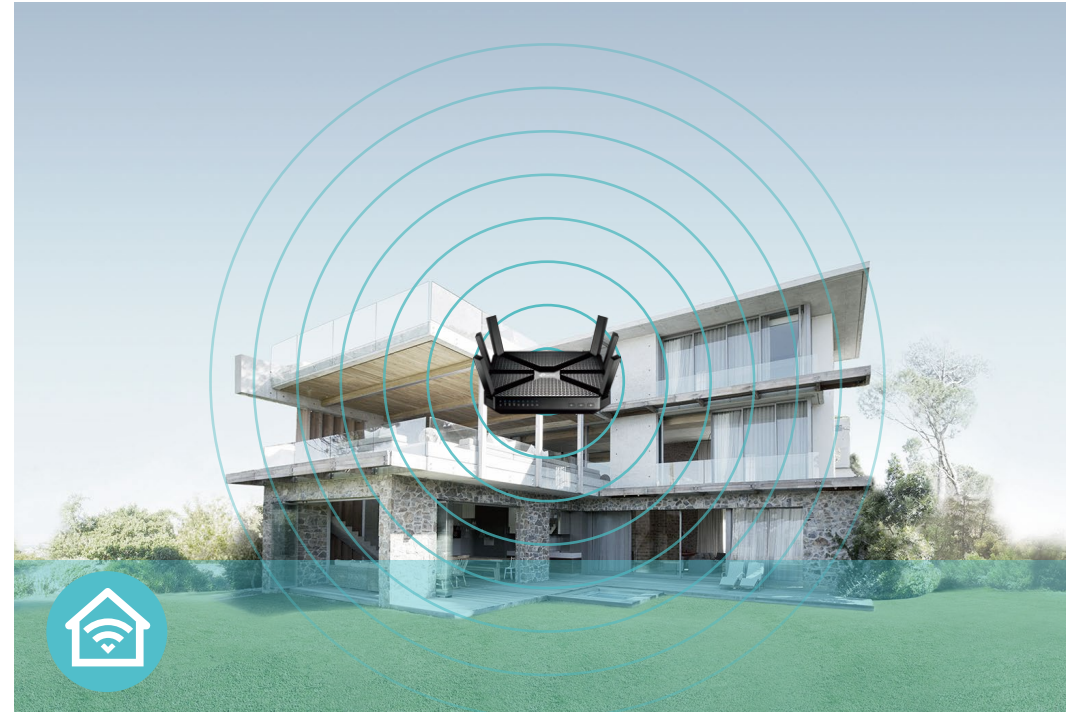

Wi-Fi Range

- **Ultimate Range Wi-Fi** – 6 high-performance antennas with a high-powered amplifier ensure the widespread Wi-Fi coverage and a stable connection
- **Wi-Fi with Beamforming** – Beamforming technology locates the connected devices and further improves the Archer C4000's range and the signal strength to each mobile device, delivering a more reliable and efficient wireless connection



Reliability

- **Simultaneous Triple Band** – Separate Wi-Fi bands enable more devices to connect to your network without a drop in performance
- **Easy Bandwidth Management** – Advanced QoS makes it easier for you to manage the bandwidth of connected devices
- **Smart Connect Technology** – Smart Connect technology automatically selects the best Wi-Fi band for each device
- **Airtime Fairness Technology** – Airtime Fairness optimizes the time usage to improve overall Wi-Fi performance

Features



Ease of Use

- Intuitive Web UI – Ensures quick and simple Installation without hassle
- Fast Encryption – One-touch WPA wireless security encryption with the WPS button
- Easy On/Off – Turn on/off wireless radio and LEDs separately using the Wi-Fi On/Off and LED On/Off buttons
- Power On/Off – Conveniently power on or off your router as required
- Hassle-free Management with Tether App – Network management is made easy with the TP-Link Tether App, available on any Android and iOS device



Security

- Guest Network – Keep your main network secure by creating a separate network for friends and visitors
- Access Control – Establish a whitelist or blacklist to allow or restrict certain devices to access the Internet
- Homecare™ – Provides a kit of dynamic - Parental Controls, QoS and Antivirus - to ensure safety, speed and security for everyone in your network
- VPN Server – PPTP VPN and OpenVPN are supported, making it easy to set up a secure connection between your private network and the Internet
- Encryptions for Secure Network – WPA-PSK and WPA2-PSK encryptions provide active protection against security threats

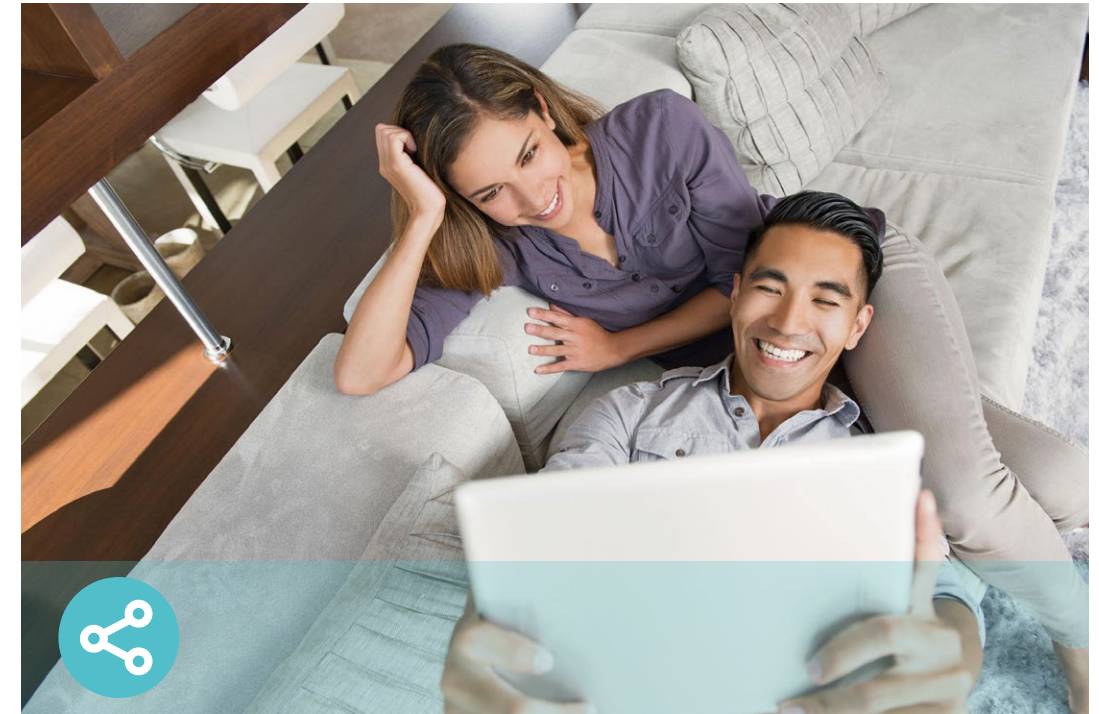

Easy Sharing

- Dual USB Ports for Fast Sharing – With one ultra-fast USB 3.0 port and one USB 2.0 port, you can access and share your files and media locally. Through the router's FTP server, you can also access your files and media from network devices remotely
- 10x Faster Transfer Speed – The USB 3.0 port provides up to 10x faster USB hard drive access than previous generation USB 2.0 connections
- Built-in Media Server – Allows you to play music, watch videos and view photos from any device on your network

Specifications

Hardware

- Ethernet Ports: 4 10/100/1000 Mbps LAN Ports, 1 10/100/1000 Mbps WAN Port
- USB Ports: 1 USB 3.0 Port, 1 USB 2.0 Port
- Buttons: Wireless On/Off Button, LED On/Off Button, Power On/Off Button, WPS Button, Reset Button
- Antennas: 6 High Performance Antennas
- External Power Supply: 12V/4A
- Dimensions (W x D x H): 7.9×7.9×1.5 in. (200×200×39 mm)

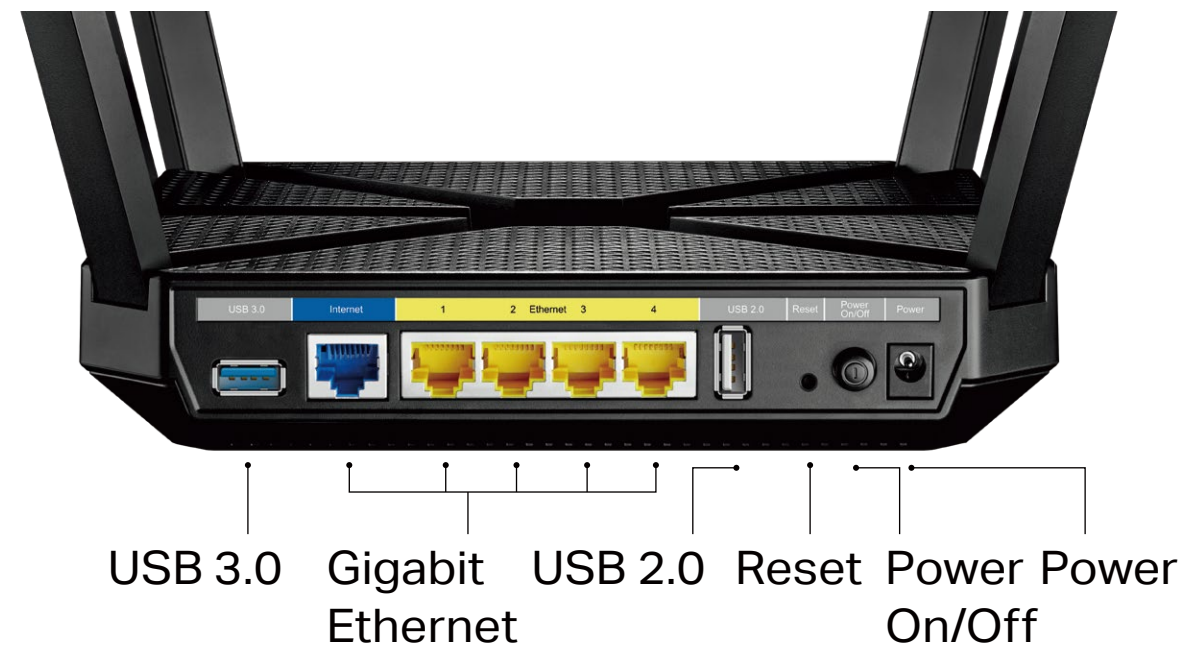

Wireless

- Wireless Standards: IEEE802.11b/g/n (support QAM1024) 2.4 GHz, IEEE 802.11ac/n/a 5 GHz
- Frequency: 2.4 GHz and 5 GHz
- Signal Rate: 1625 Mbps at 5 GHz-1, 1625 Mbps at 5 GHz-2, 750 Mbps at 2.4 GHz
- CE EIRP: <20 dBm (2.4 GHz), <23 dBm (5 GHz)
- FCC Transmit Power: <30 dBm (2.4 GHz & 5 GHz)
- Reception Sensitivity:
 - 5 GHz:
 - 11a 6 Mbps: -95 dBm, 11a 54 Mbps: -75 dBm
 - 11ac VHT20(MCS0): -95 dBm, 11ac VHT20(MCS11): -63 dBm
 - 11n HT40(MCS0): -92 dBm, 11ac HT40(MCS7): -73 dBm
 - 11ac VHT80(MCS0): -89 dBm, 11ac VHT80(MCS11): -58 dBm
 - 2.4 GHz:
 - 11g 54Mbps: -78 dBm
 - 11n HT20(MCS0): -96 dBm, 11ac VHT20(MCS11): -65 dBm
 - 11n HT40(MCS0): -93 dBm, 11ac VHT40(MCS11): -63 dBm
- Wireless Function: Enable/Disable Wireless Radio, WMM
- Wireless Security: 64/128-bit WEP, WPA/WPA2, WPA-PSK/WPA-PSK2 encryptions

Specifications

Software

- Quality of Service: WMM
- WAN Type: Dynamic IP, Static IP, PPPoE, PPTP(Dual Access), L2TP(Dual Access), Bigpond
- Management: Access Control, Local Management, Remote Management
- DHCP: Server, DHCP Client List, Address Reservation
- Port Forwarding: Virtual Server, Port Triggering, UPnP, DMZ
- Dynamic DNS: TP-Link, NO-IP, DynDns
- VPN Server: PPTP, Open VPN
- Access Control: Local Management Control, Host list, Rule Management
- Homecare™: Parental Controls, QoS and Antivirus
- Firewall Security: SPI Firewall, IP and MAC Address Binding
- Protocols: IPv4, IPv6
- USB Sharing: Supports Samba(Storage), FTP Server, Media Server
- Guest Network: 2.4 GHz Guest Network x 1, 5 GHz Guest Network x 2

Others

- Certification: CE, FCC, RoHS
- System Requirements: Microsoft Windows 98SE/NT/2000/XP/Vista™/7/8/8.1/10, MAC OS, NetWare, UNIX or Linux
Internet Explorer 11, Firefox 12.0, Chrome 20.0, Safari 4.0, or other Java-enabled browser
Cable or DSL Modem
Subscription with an Internet Service Provider (for internet access)
- Environment: Operating Temperature: 0°C~40°C (32°F ~104°F)
Storage Temperature: -40°C~70°C (-40°F ~158°F)
Operating Humidity: 10%~90% non-condensing
Storage Humidity: 5%~90% non-condensing
- Package Contents
Wireless Router Archer C4000
Power Adapter
RJ45 Ethernet Cable
Quick Installation Guide



For more information, please visit

<https://www.tp-link.com/us/products/details/Archer-C4000.html>

or scan the QR code left

Attention: This device may only be used indoors in all EU member states and EFTA countries.

Specifications are subject to change without notice. All the brands and product names are trademarks or registered trademarks of their respective holders.

* Maximum wireless transmission rates are the physical rates derived from IEEE Standard 802.11 specifications. Range and coverage specifications are based on test results under normal usage conditions. Actual wireless transmission rate and wireless coverage are not guaranteed, and will vary as a result of 1) environmental factors, including building materials, physical objects and obstacles, 2) network conditions, including local interference, volume and density of traffic, product location, network complexity, and network overhead and 3) client limitations, including rated performance, location, connection quality, and client condition.

*Use of MU-MIMO requires clients to also support MU-MIMO.

©2020 TP-Link

www.tp-link.com

TP-Link AC4000 MU-MIMO Tri-Band Wi-Fi Router Archer C4000