

Stainless Steel Glass Door Reach-In Freezer



www.sub-equip.com

Features

- CFC free refrigerant and foam insulation
- Electronic thermostat and digital LED temperature display for accurate control and easy reading
- Self-closing door
- Magnetic gasket can be replaced without any tools
- Energy efficient Low-e triple pane glass doors with heater on glass and inside door frame
- Auto defrosting and auto evaporation to prevent condensation
- Condensation pan efficiently evaporates excess water
- INTERIOR: 304 Stainless steel
- EXTERIOR: 430 Stainless Steel, plastic top sign panel with lamp
- LED interior lighting to enhance product display
- Heavy-duty polyethylene coated adjustable wire shelves
- Easy to mount 4" casters (front casters with brakes) are standard with all units

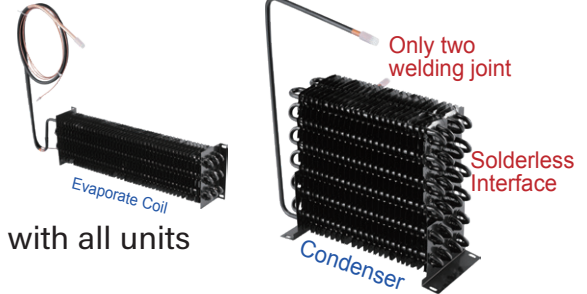

Temperature

- Interior temperature range: 1°C to 4°C (33°F to 40°F)



C-13FG/C-19FG/C-27FG

C-35FG/C-48FG/C-54FG

C-81FG

Specifications

Model	Doors	Ext. Dimensions W x D x H (in)	Storage Capacity(cu./ft)	Shelves	V/Hz/Ph	AMPS	Power	NEMA PLUG	Ship Weight(lbs)	Ship Data W x D x H (in)
C-13FG	1	22 3/4 x 23 7/8 x 80 7/8	12.7	5	115/60/1	4	500W/0.67HP	5-15P	199	25 x 26 1/4 x 88 3/4
C-19FG	1	26 3/4 x 25 5/8 x 80 7/8	16.5	5	115/60/1	7	700W/0.94HP	5-15P	287	29 1/4 x 28 x 88 3/4
C-27FG	1	26 3/4 x 32 x 80 7/8	21.5	5	115/60/1	7.5	800W/1.08HP	5-15P	342	29 1/4 x 35 x 88 3/4
C-35FG	2	39 1/2 x 32 x 80 7/8	32.6	10	115/60/1	7.5	800W/1.08HP	5-15P	419	47 7/8 x 35 x 88 3/4
C-48FG	2	48 x 32 x 80 7/8	40.1	10	115/60/1	14	1400W/1.88HP	5-15P	461	50 1/2 x 35 x 88 3/4
C-54FG	2	54 x 32 x 80 7/8	45.2	10	115/60/1	14	1400W/1.88HP	5-15P	529	56 3/8 x 35 x 88 3/4
C-81FG	3	80 3/4 x 32 x 80 7/8	68.5	15	115/60/1	15	1600W/2.15HP	5-15P	771	83 x 35 x 88 3/4



Natural
Refrigerant

If the data and structure update, without notice, subject to material object.

Stainless Steel Glass Door Reach-In Freezer

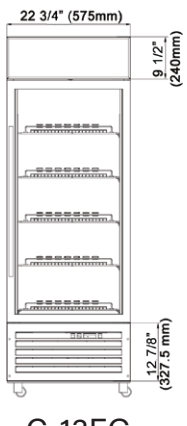

C-13FG

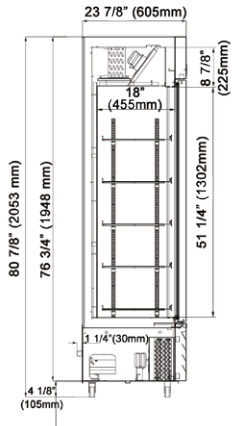

C-19FG

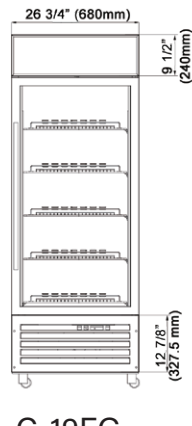

C-27FG

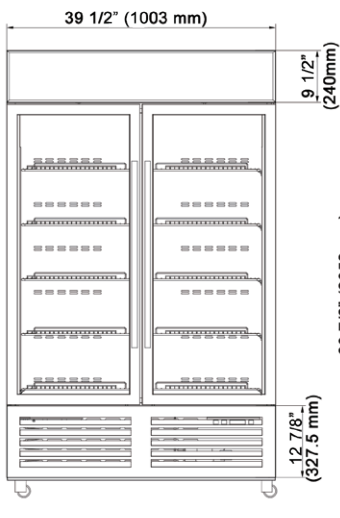
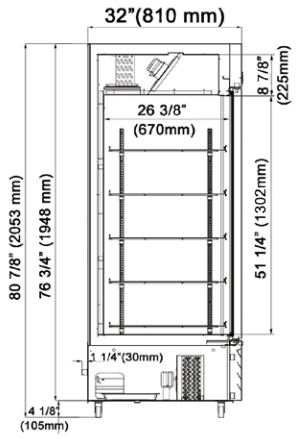
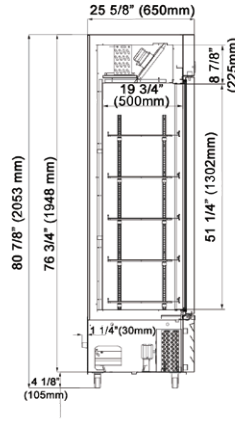

C-35FG

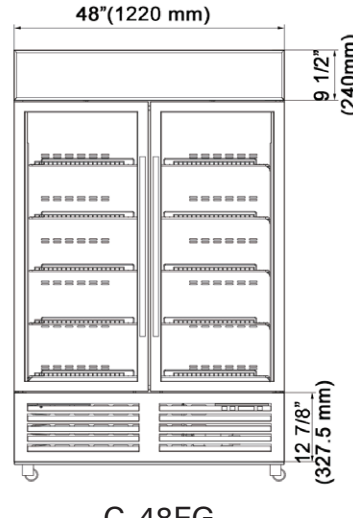
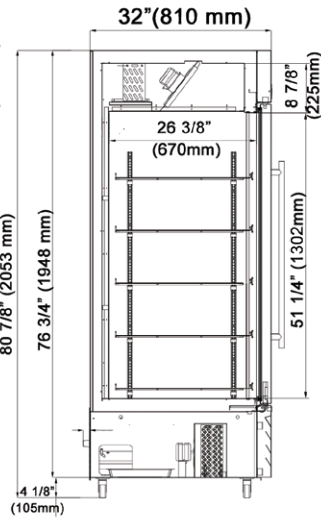

C-48FG

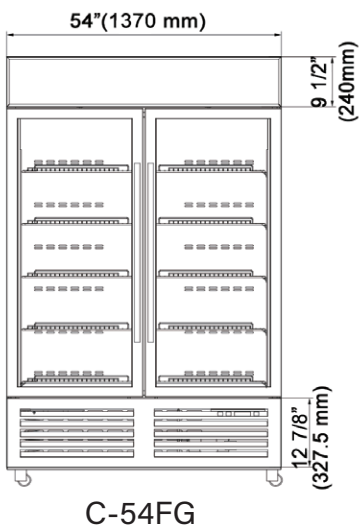
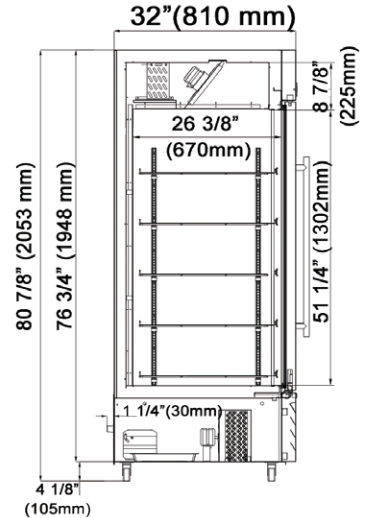

C-54FG

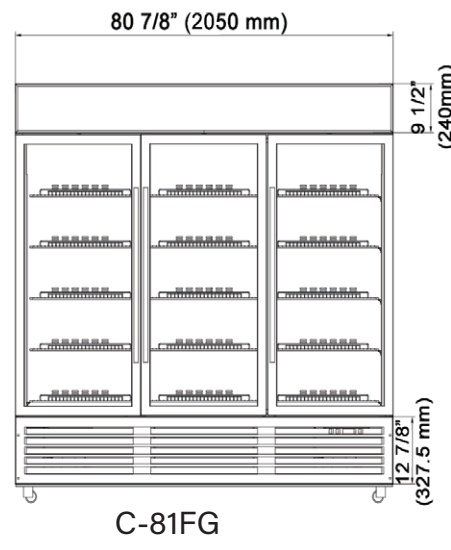
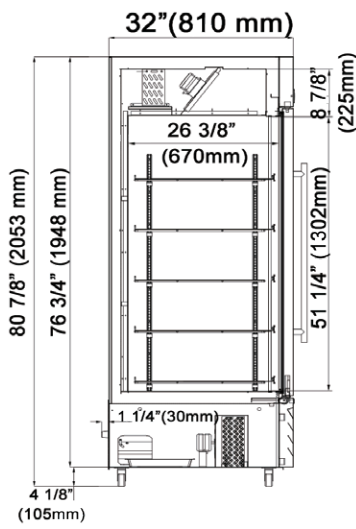

C-81FG

