

# Salad & Sandwich Prep Table - Regular Top Refrigerator

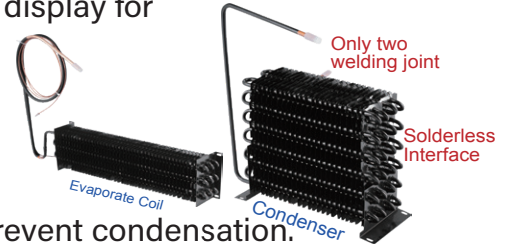

## Features

- CFC free refrigerant and foam insulation.
- Equipped with an electronic thermostat and digital LED temperature display for precise control and convenient reading.
- Features a self-closing swing door for added convenience.
- The magnetic gasket can be replaced without the need for any tools.
- External construction comprises stainless steel framework.
- Internally constructed with 304 stainless steel.
- Incorporates auto defrosting and auto evaporation mechanisms to prevent condensation.
- The coated copper tube, boasting a sturdy 0.7mm thickness, ensures durability.
- Crafted from a single bent tube, minimizing the risk of leaks with only two welding joints.
- The condenser is efficiently positioned inside the condensation pan to facilitate the evaporation of excess water.
- Dispose of daily waste effortlessly with the stainless steel baseplate that lifts easily.
- Adjustable and heavy-duty epoxy-coated wire shelves for flexible storage options.
- Includes 1/6 size polycarbonate GN pans and a plastic cutting board.
- Comes with easy-to-mount 4" casters (front casters equipped with brakes), standard with all units.
- Electrical specifications: 115/60/1 with a NEMA 5-15P plug and a 10ft cord.



## Temperature

- Interior temperature range: 1°C to 4°C ( 33°F to 40°F)

## Warranty

- 3 years parts and labour
- 5 years compressor warranty



CSSU-29



CSSU-36



CSSU-48/ CSSU-60



CSSU-72



## Specifications

Model	Doors	1/6 Size Pan	Ext. Dimensions W x D x H (in)	Int.. Dimensions W x D x H (in)	V/Hz/Ph	AMPS	Power	Storage Capacity(cu-ft)	NEMA PLUG	Ship Weight(lbs)	Ship Data W x D x H (in)
CSSU-29	1	8	29 x 31 7/8 x 35 5/8 (42 1/2)	25 1/8 x 24 x 24 3/8	115/60/1	3	250W/0.34HP	7.5	5-15	223	32 1/8 x 33 3/8 x 45 7/8
CSSU-36	2	10	36 1/4 x 31 7/8 x 35 5/8 (42 1/2)	32 1/4 x 24 x 24 3/8	115/60/1	3	300W/0.40HP	11	5-15	243	39 1/2 x 33 3/8 x 45 7/8
CSSU-48	2	12	48 1/4 x 31 7/8 x 35 5/8 (42 1/2)	42 7/8 x 24 x 24 3/8	115/60/1	4	380W/0.51HP	12.5	5-15	287	51 1/2 x 33 3/8 x 45 7/8
CSSU-60	2	16	61 1/8 x 31 7/8 x 35 5/8 (42 1/2)	55 7/8 x 24 x 24 3/8	115/60/1	4.5	400W/0.54HP	16	5-15	393	64 1/2 x 33 3/8 x 45 7/8
CSSU-72	3	20	71 3/4 x 31 7/8 x 35 5/8 (42 1/2)	66 3/8 x 24 x 24 3/8	115/60/1	4.5	400W/0.54HP	19	5-15	472	75 x 33 3/8 x 45 7/8



If the data and structure update, without notice, subject to material object.

# Salad & Sandwich Prep Table

## Regular Top Refrigerator



CSSU-29

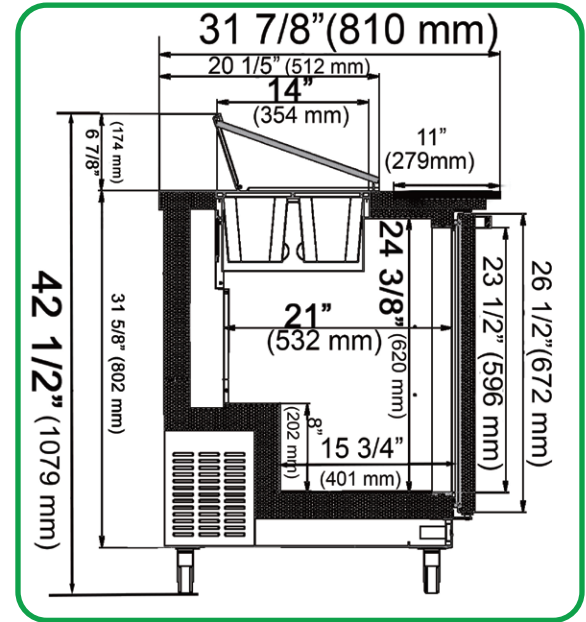
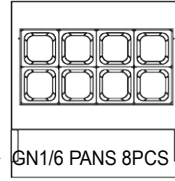
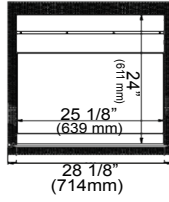
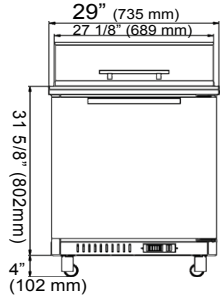

CSSU-36

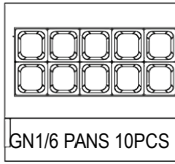
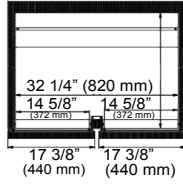
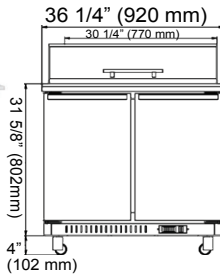

CSSU-48

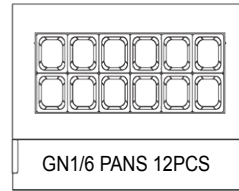
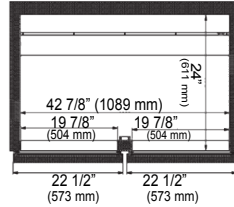
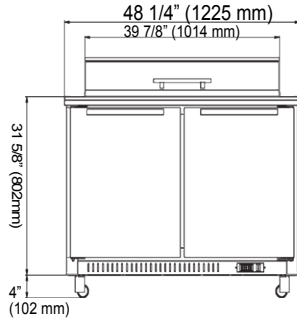

CSSU-60

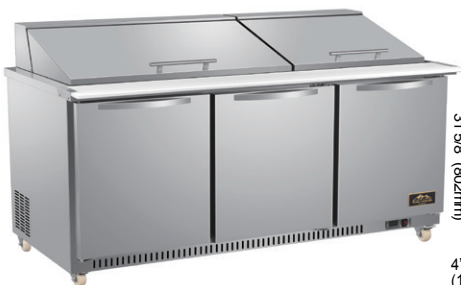
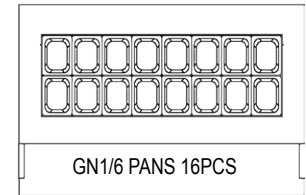
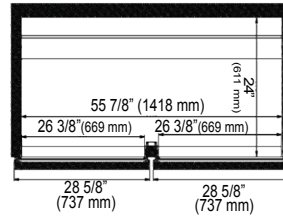
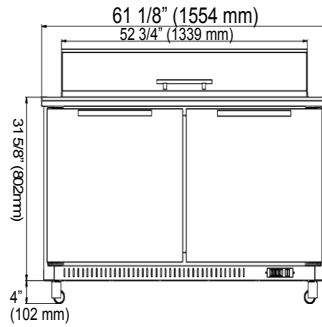

CSSU-72

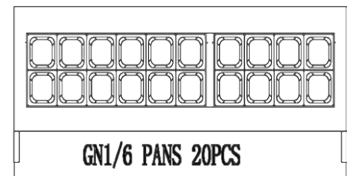
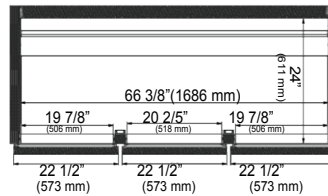
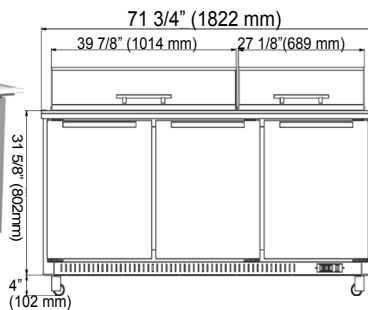

If the data and structure update, without notice, subject to material object.