

sphero®  
littleBits  
**STEAM  
STUDENT SET**  
INVENTION GUIDE

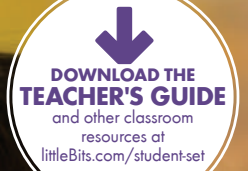

↓  
**DOWNLOAD THE  
TEACHER'S GUIDE**  
and other classroom  
resources at  
[littleBits.com/student-set](http://littleBits.com/student-set)

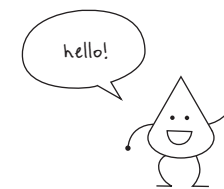



Find the Invention Guide at  
**[LITTLEBITS.COM/STUDENT-SET](http://LITTLEBITS.COM/STUDENT-SET)**



sphero®  
**littleBits**  
**STEAM**  
**STUDENT SET**  
**INVENTION GUIDE**



PG 32



PG 39



PG 46



PG 53

**04** littleBits Basics

**06–27** **BIT™ INDEX**

**07** **POWER**

**09** **INPUT**

**14** **WIRE**

**17** **OUTPUT**

**24** **ACCESSORIES**

**28** Inventing  
with littleBits

**32–58** **GUIDED CHALLENGES**

Guided challenges start with instructions for a simple invention. Once you've created the invention, the challenge moves into the Remix phase where creativity really takes off.

**32** Invent a Self-Driving Vehicle

**39** Invent an Art Machine

**46** Invent a Throwing Arm

**53** Invent a Security Device

**59–70** **OPEN CHALLENGES**

Open challenges get you to flex your creative muscles. These challenges start with an open-ended problem. Your mission is to explore ways you could use littleBits to create an invention that solves that problem.

**59** Hack Your Classroom

**62** Invent for Good

**65** Invent a Chain Reaction Contraption

**68** Hack Your Habits

**71** Trouble-  
shooting  
Tips

**72** Continue  
Your Inventor  
Journey

**STEAM** is the evolution of **STEM** education, adding *Art* to Science, Technology, Engineering, and Math. Students gain technical skills by exploring creative, collaborative solutions to real-world problems.

The challenges in the littleBits STEAM Student Set link to **NGSS** (Next Generation Science Standards) Engineering Design standards.



**TEACHER'S GUIDE** and other classroom resources available at [classroom.littlebits.com/kits/steam-student-set](https://classroom.littlebits.com/kits/steam-student-set)



**SHARE & DISCOVER** inventions online at [classroom.littlebits.com](https://classroom.littlebits.com)





WE IN INVE  
WORLD  
WANT TO





MENT  
NT THE  
WE  
O LIVE

**BUILD & PLAY  
WITH THIS  
CIRCUIT FIRST**



# littleBits™ BASICS

## ANATOMY OF A BIT™

Learn how you can tell top from bottom.

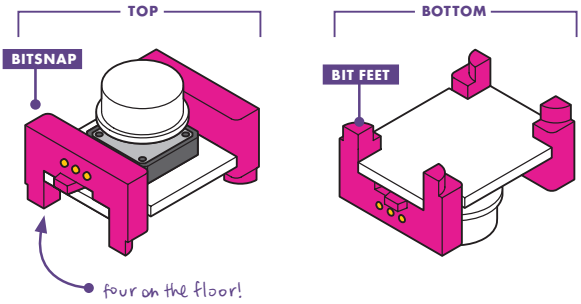

## COLOR-CODED BY FUNCTION

Bits™ are grouped into four different categories, which are color-coded.

### A POWER (BLUE)

Power Bits, plus a power supply, run power through your circuit.

### C WIRE (ORANGE)

Wire Bits connect to other systems and let you build circuits in new directions.

### B INPUT (PINK)

Input Bits accept input from you or the environment and send signals that affect the Bits that follow.

### D OUTPUT (GREEN)

Output Bits do something - light up, buzz, move...

Learn more about your Bits starting **ON PG 06**





### MAGNET MAGIC!

Bits snap together with magnets. The magnets are always right – you can't snap them together the wrong way.

#### ARROWS SHOULD POINT IN THE SAME DIRECTION

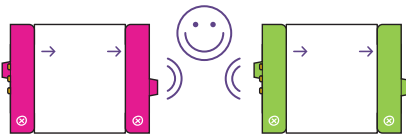

IF THE BITS WON'T SNAP TOGETHER, TRY SPINNING ONE AROUND AND MAKE SURE THE ARROWS POINT IN THE SAME DIRECTION

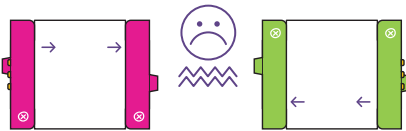

### ORDER IS IMPORTANT

**POWER BITS** always come first and **INPUT BITS** only affect the **OUTPUT BITS** that come after them.

WITH NO OUTPUT BIT AFTER IT, THE INPUT BIT HAS NOWHERE TO SEND ITS SIGNAL

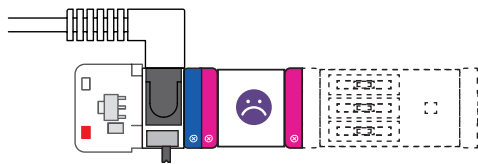

THE INPUT BIT AFFECTS THE OUTPUT BITS THAT FOLLOW

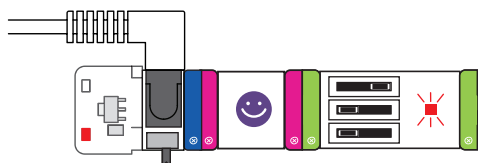

### SOME BITS ARE ADJUSTABLE

Switches, buttons, and sliders on the board allow you to change how the Bit functions.

FLIP THE SWITCH TO CHANGE MODES

MOVE THE SLIDER TO ADJUST SENSITIVITY

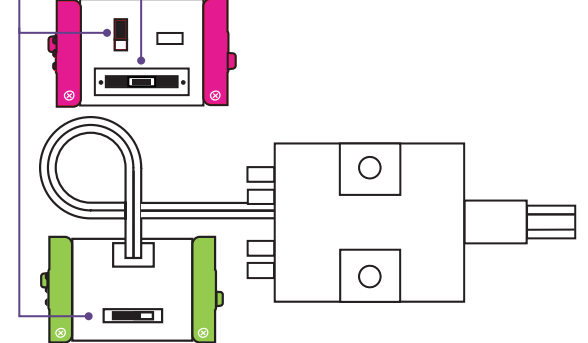





# littleBits<sup>®</sup> BIT™ INDEX

## POWER

- 07** p7 power
- 08** p3 USB power

## INPUT

- 09** i3 button
- 10** i5 slide dimmer
- 11** i12 temperature sensor
- 12** i13 light sensor
- 13** i16 pulse

## WIRE

- 14** w1 wire
- 15** w7 fork
- 16** w10 inverter

## OUTPUT

- 17** o2 long LED
- 18** o6 buzzer
- 19** o11 servo
- 20** o13 fan
- 21** o19 RGB LED
- 22** o21 number
- 23** o25 DC motor

## ACCESSORIES

- 24** a5 magnet shoes  
a6 hook & loop shoes  
a30 mounting board
- 25** a10 motorMate  
USB cable
- 26** a25 wheel  
a23 mechanical arm
- 27** a31 battery mount

\* Occasionally Bits™ get updated, so the features or appearance of your Bits may differ from those used in this guide.



## p7 POWER

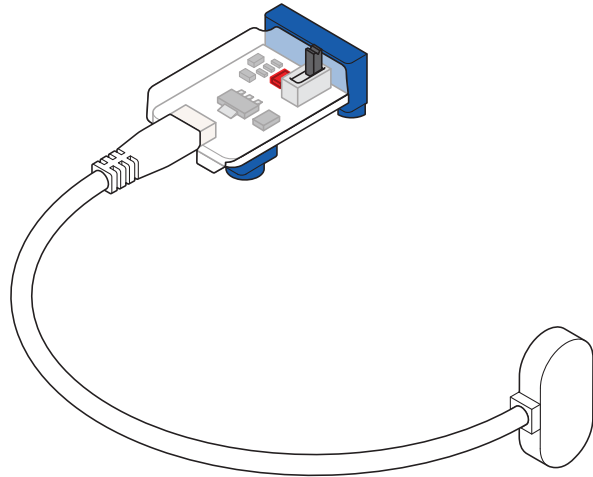

### MEET THE BIT

Every circuit starts with power. It provides the electricity that makes your Bits spin, buzz, blink, and shine.

### SAMPLE CIRCUIT

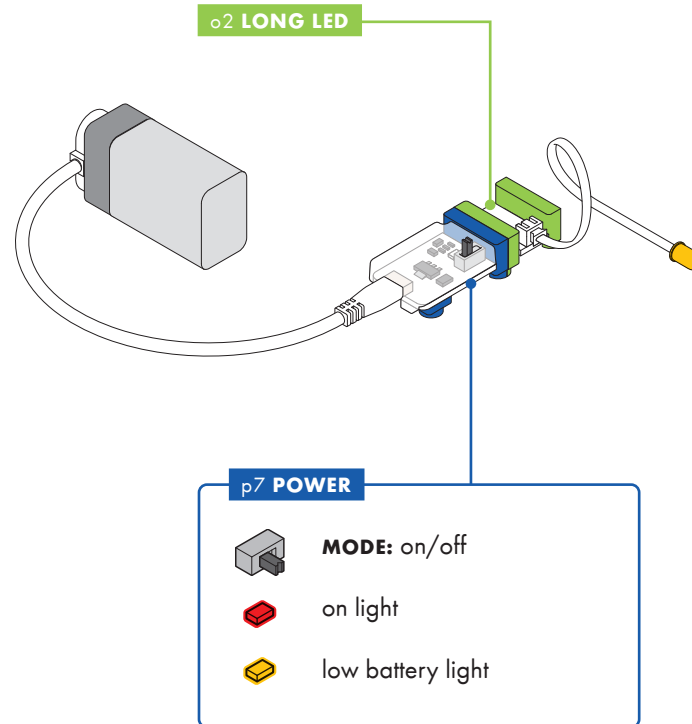

### HOW IT WORKS

The p7 power Bit converts the 9 volts of electricity in the battery to the 5 volts that littleBits circuits run on.

The power Bit also sends a signal through your circuit. Controlling this signal with inputs is how you control your circuit.

### REAL WORLD ANALOGIES



PHONE CHARGER



## p3 USB POWER

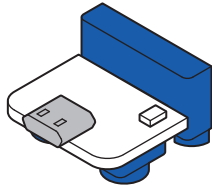

### MEET THE BIT

The USB power may be the smallest in the series, but it's big enough to send electricity to all your creations. This Bit lets you power your circuit through a micro USB cable. It can be connected to a computer or wall adapter for non-stop power.

### SAMPLE CIRCUIT

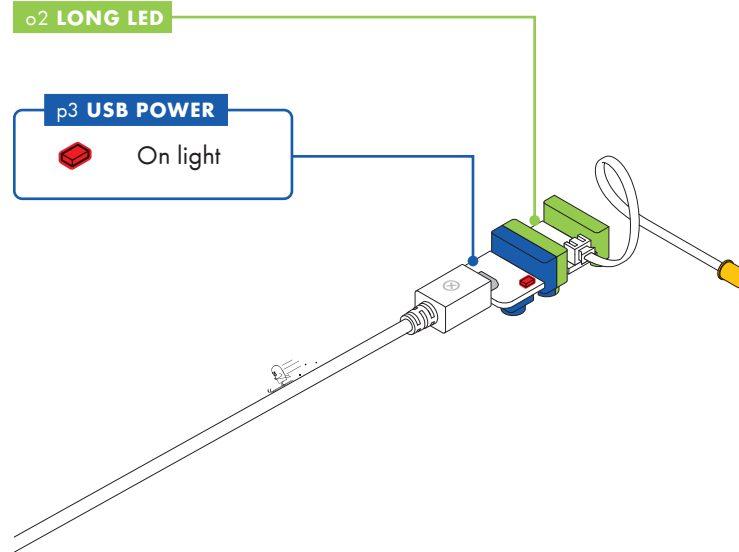

### HOW IT WORKS

Like the power Bit, the USB power Bit sends a 5 volt signal through your circuit, which allows you to control your Bits.

Instructions for the projects in this Kit use the p7 power Bit, but you can use the USB power for all of them as well.

### REAL WORLD ANALOGIES



PHONE CHARGER



LAPTOP CHARGER







## i3 BUTTON

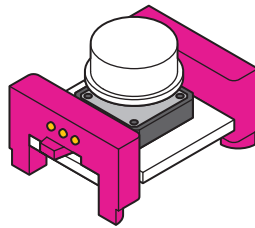

### MEET THE BIT

The button Bit is a classic: big, round, and springy for comfortable pressing! Push it to turn something on and release it to turn it off.

### SAMPLE CIRCUIT

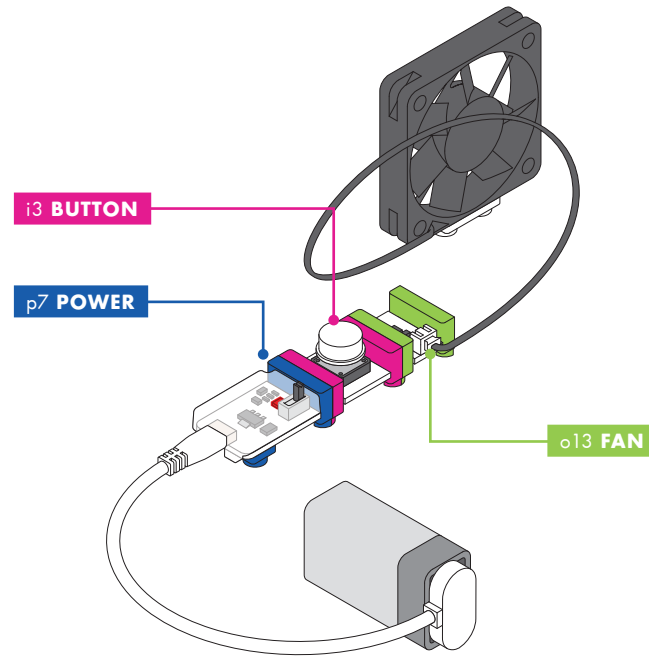

### HOW IT WORKS

The button is like a door. When you press it, the door opens, letting the signal pass through the Bit and on to the next Bits in the circuit. The button is a momentary switch, you must continue to press it for the signal to flow. When you release the button, the door closes, stopping the signal from passing on to other Bits.

### MINI-CHALLENGE

Can you invent a chair that makes noise when you sit down?

### REAL WORLD ANALOGIES



VIDEO GAME CONTROLLER



ELEVATOR BUTTON



GAME SHOW BUZZER





## i5 SLIDE DIMMER

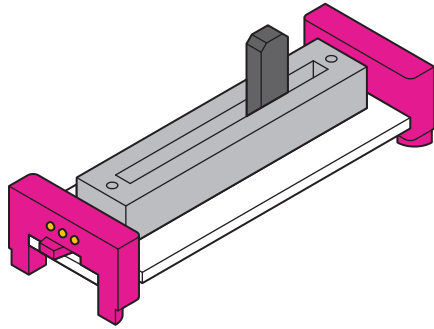

### MEET THE BIT

Slide this dimmer back and forth to control your circuit. As you slide it up, more signal goes to the Bits that follow, brightening lights, speeding up motors, and raising the volume on your buzzer.

### MINI-CHALLENGE

Can you invent something with the slide dimmer that waves a flag back and forth? How could you change the speed that it waves?

### SAMPLE CIRCUIT

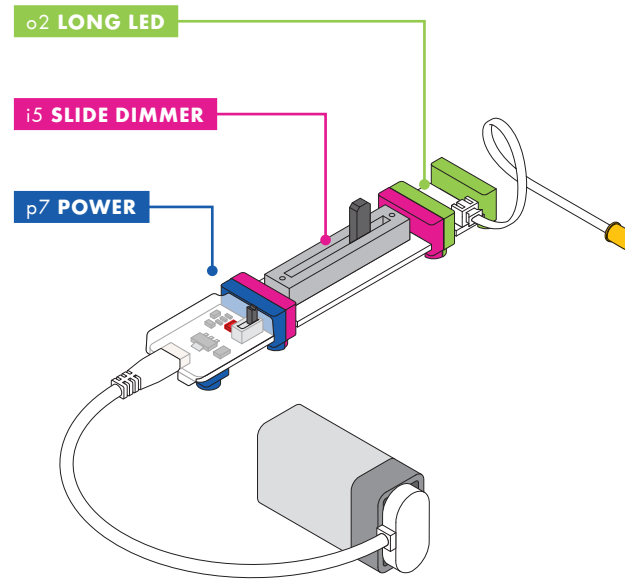

### HOW IT WORKS

When the slider is all the way to the left, it's sending an off or 0 volt signal. When the slider is all the way to the right, it's sending a 5 volt signal. The slider can be positioned to send any signal between 0 and 5 volts.

### REAL WORLD ANALOGIES



HOUSEHOLD DIMMER SWITCH



STEREO VOLUME CONTROL



CAR PEDAL



## i12 TEMPERATURE SENSOR

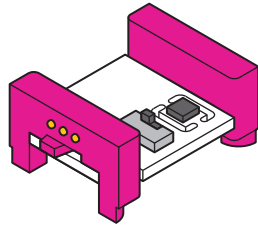

### MEET THE BIT

With the temperature sensor you can use the temperature in the surrounding air to control your circuit. It's especially useful for gathering data when paired with the number Bit set to **VALUE** mode.

### MINI-CHALLENGE

Can you invent a temperature-controlled gadget to beat the summer heat?

## SAMPLE CIRCUIT

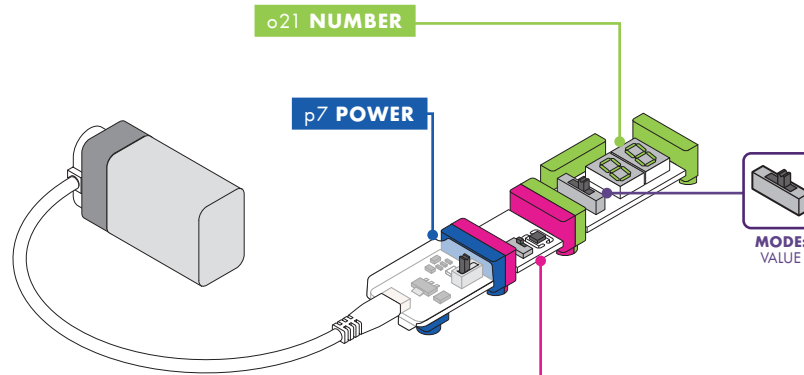

### i12 TEMPERATURE SENSOR



**MODE:** F° or C°



This is the component that measures the temperature.

## HOW IT WORKS

The temperature sensor takes a measurement from the environment and translates it into a signal. The higher the temperature it senses, the more signal it sends out to the following Bits (making lights brighter and motors turn faster).

## REAL WORLD ANALOGIES

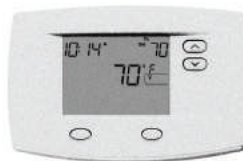

THERMOSTAT



MEDICAL THERMOMETER



AUTOMATIC TEA KETTLE

*A temperature sensor tells your automatic kettle when to turn off.*





## i13 LIGHT SENSOR

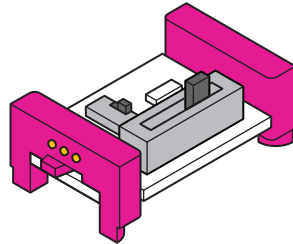

### MEET THE BIT

Use this Bit to control your circuits with light! The amount of light shining on the sensor will change how your circuit behaves. It's a great way to activate your circuit without hands and is perfect for alarms!



### MINI-CHALLENGE

Can you invent something that moves when the lights go out?

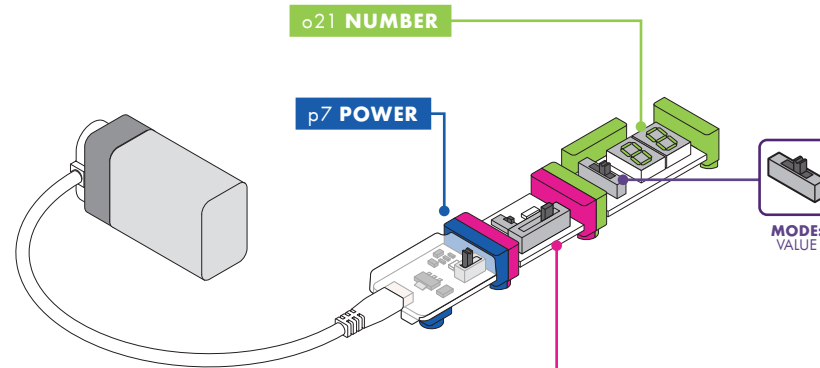
### SAMPLE CIRCUIT



### i13 LIGHT SENSOR

-  **MODE:** light or dark
-  **SENSITIVITY:** "-" decrease, "+" increase
-  This is the component that measures light.

### HOW IT WORKS

The light sensor measures how much light is shining on it. It has two modes. In **LIGHT** mode, as the light shining on the sensor gets brighter, more signal passes through it (making lights brighter or motors turn faster). In **DARK** mode, the signal increases as it gets darker.

Use the slider to adjust how much light it takes to change the signal. Moving it to the right increases sensitivity, and to the left decreases it.

### REAL WORLD ANALOGIES



NIGHT LIGHT SENSOR



PHOTOGRAPHER'S LIGHT METER

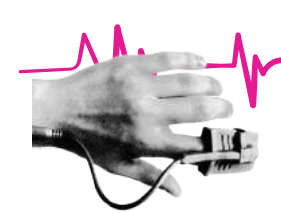

FINGER PULSE METER

*A pulse meter shines a bright light into your finger and uses a light sensor to measure blood flow.*





## i16 PULSE

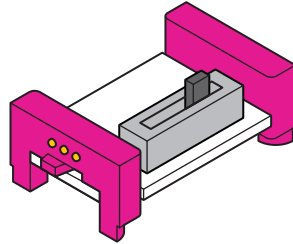

### MEET THE BIT

The pulse is like a heartbeat that makes the Bits after it turn on and off in a steady rhythm.

### SAMPLE CIRCUIT

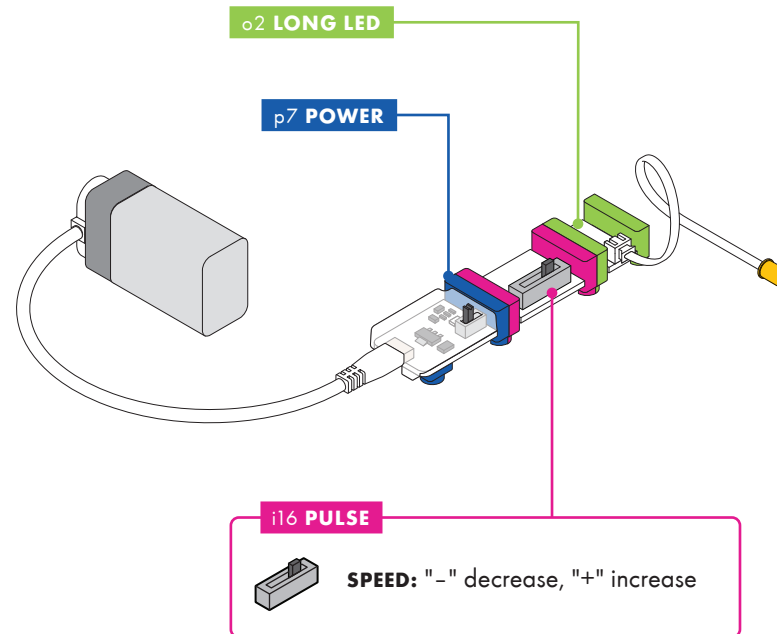

### HOW IT WORKS

The pulse is a switch that opens and closes over and over again. When it's open, the signal from the previous Bit passes through to the next Bit. When the switch closes, the signal is blocked.

Use the slider to adjust the speed of the pulse. Moving the slider to the right will increase the speed of the pulse.

### MINI-CHALLENGE

Can you invent a warning signal with the pulse? How can you make the signal pulse faster or slower?

### REAL WORLD ANALOGIES



POLICE SIREN



FIREFLY



TURN SIGNAL



CLOCK SECONDHAND



## w1 WIRE

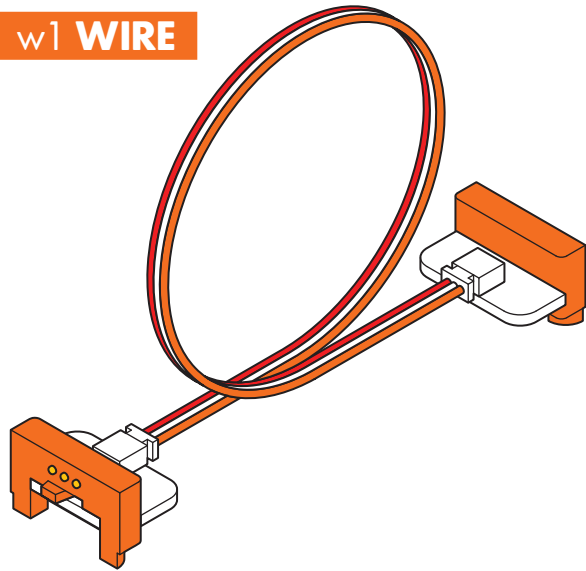

### MEET THE BIT

The wire Bit has a flexible wire running between its two bitSnaps. This allows you to place your Bits farther apart, turn corners, and make connections that can twist, turn, and spin.

### MINI-CHALLENGE

Can you invent a circuit that uses the wire to shine the long LED on the light sensor?

### SAMPLE CIRCUIT

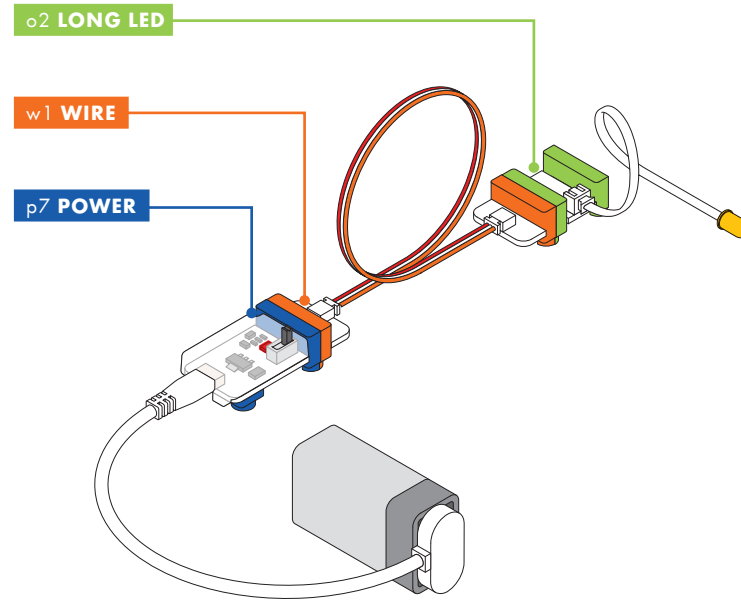

### HOW IT WORKS

The wire doesn't change the signal in any way – it just carries it over from one Bit to another.

### REAL WORLD ANALOGIES



EXTENSION CORD

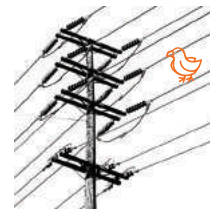

POWER LINES



STRING OF LIGHTS





## w7 FORK

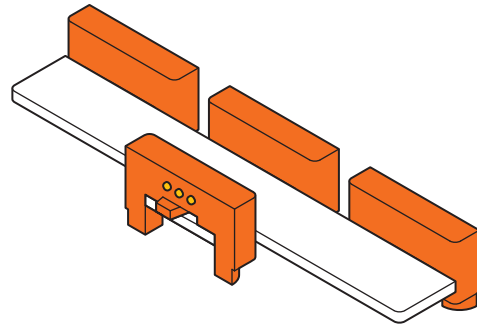

### MEET THE BIT

The fork gives you more options for connecting your Bits; it lets you connect a single Bit to as many as three others. If you place an input before the fork, it will control all three outputs at once, such as light, sound, and motion.

### MINI-CHALLENGE

Can you invent a circuit where an input controls three outputs?

## SAMPLE CIRCUIT

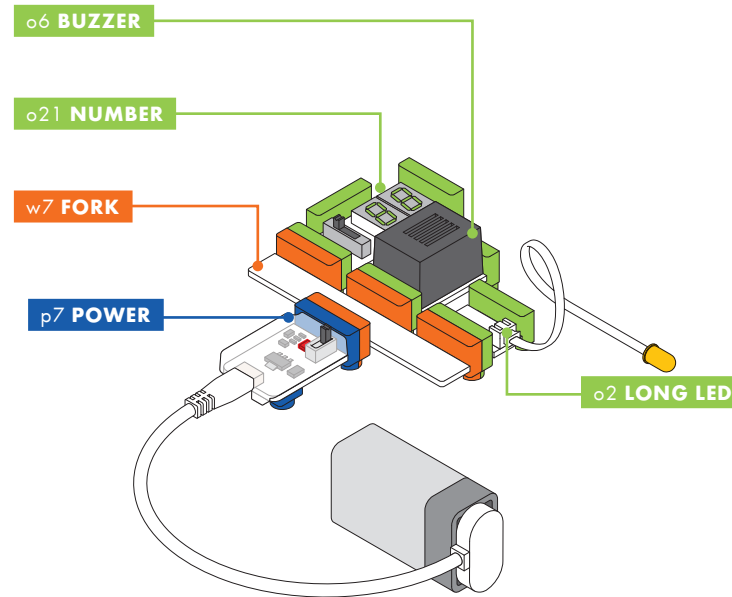

## HOW IT WORKS

The fork takes the incoming signal and sends it to all three output bitSnaps.

## REAL WORLD ANALOGIES



POWER STRIP



FORK IN THE ROAD



## w10 INVERTER

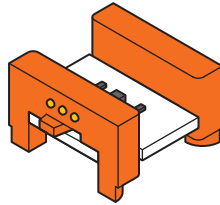

### MEET THE BIT

The inverter is an example of a logic Bit. It sends out the opposite of whatever it receives: send it an *on* signal, and the inverter changes it to an *off* signal, or vice versa. Would you like a button that turns things *off* instead of *on*? Try the inverter.

### MINI-CHALLENGE

Can you invent something with the inverter that alerts you if someone takes a book off the table?

### SAMPLE CIRCUIT

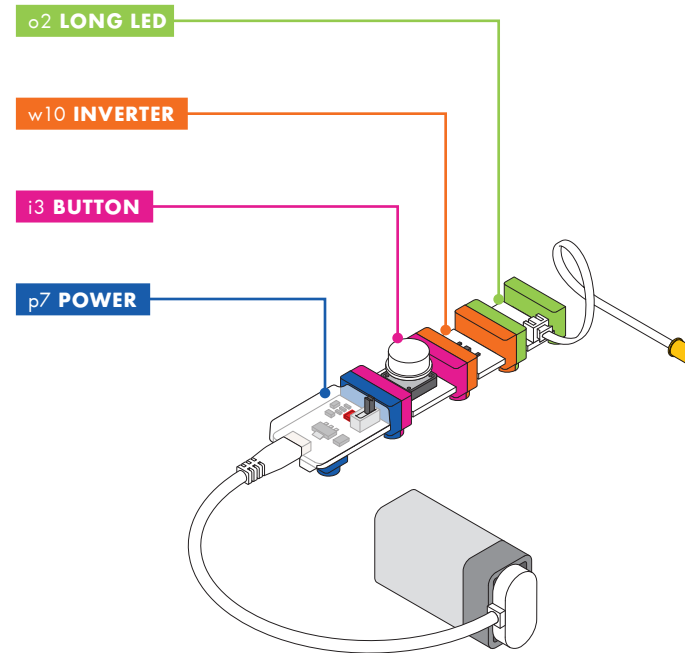

### HOW IT WORKS

Anytime the inverter receives a signal lower than 50% power (2.5 volts) the inverter sends full power (5 volts) to the next Bit in the circuit. If the inverter receives a signal greater than 2.5 volts, the inverter sends 0 volts to the next Bit in the circuit.

### REAL WORLD ANALOGIES



OPPOSITE DAY

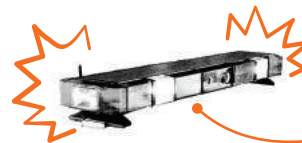

ALTERNATING POLICE LIGHTS

*Try this: power, pulse, light, inverter, light.*



## o2 LONG LED

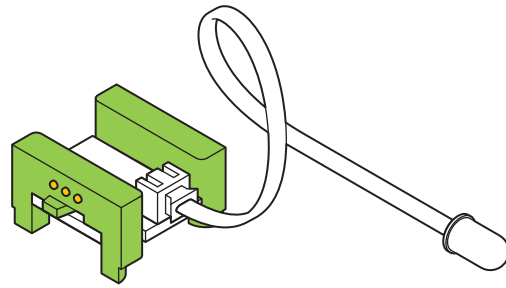

### MEET THE BIT

The long LED is a flexible lighting option. We call it the "long" LED because the light is connected to the board by a cable, which lets you put the light in some interesting places.

### MINI-CHALLENGE

Can you invent a new wearable accessory using the long LED?

## SAMPLE CIRCUIT

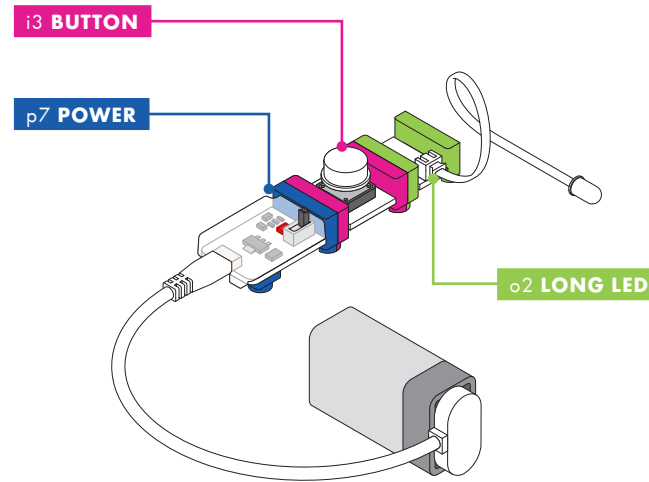

## HOW IT WORKS

This Bit uses a light-emitting diode (LED) to turn electricity into light. The more signal you send the Bit, the brighter the light shines.

## REAL WORLD ANALOGIES



FLASHLIGHT



STREET LAMP

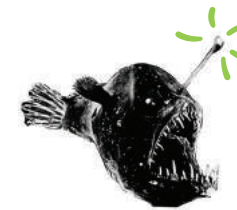

ANGLERFISH



## o6 BUZZER

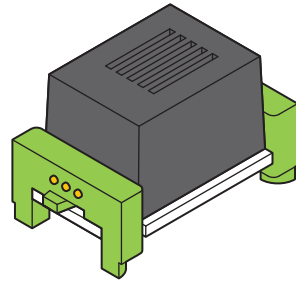

### MEET THE BIT

The buzzer makes a sound no one can ignore. It's great at sounding the alarm or annoying those nearby.

### MINI-CHALLENGE

Can you invent a way to communicate with your friends using the buzzer?

### SAMPLE CIRCUIT

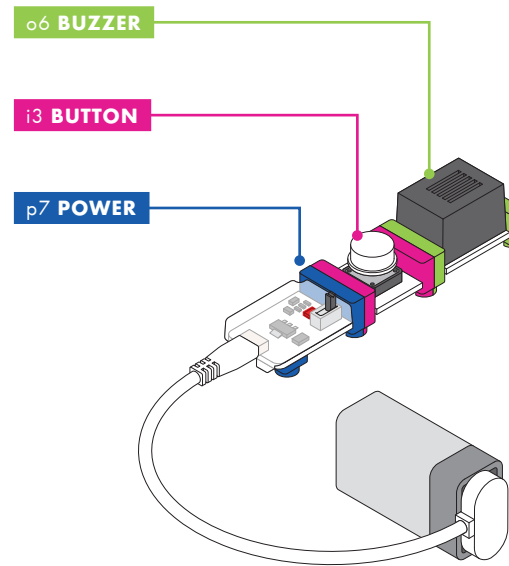

### HOW IT WORKS

The buzzer converts the electrical signal it receives into a vibration, which creates a buzzing sound. The higher the signal it receives, the more intense the vibration, and the louder the sound is.

### REAL WORLD ANALOGIES

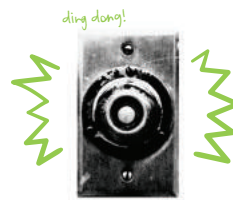

DOORBELL



CAR ALARM



WASHING MACHINE





## o11 SERVO

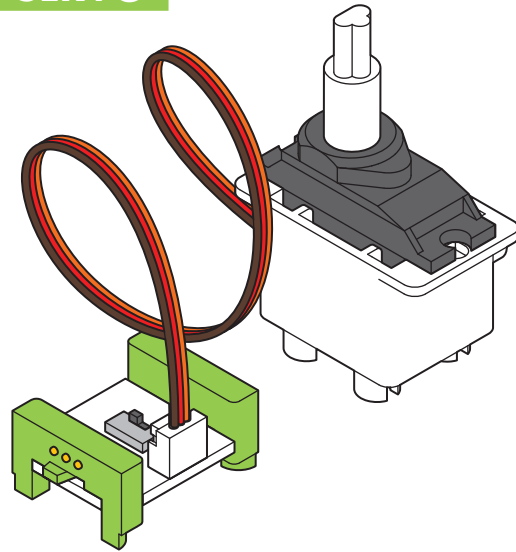

### MEET THE BIT

The servo is a motor that can swing back and forth or be turned to a specific position.

There are a few accessories you can use with the servo (like the mechanical arm). You can find out how to use those on page 26.

### MINI-CHALLENGE

Can you invent something that uses the servo to clean up your desk?

## SAMPLE CIRCUIT

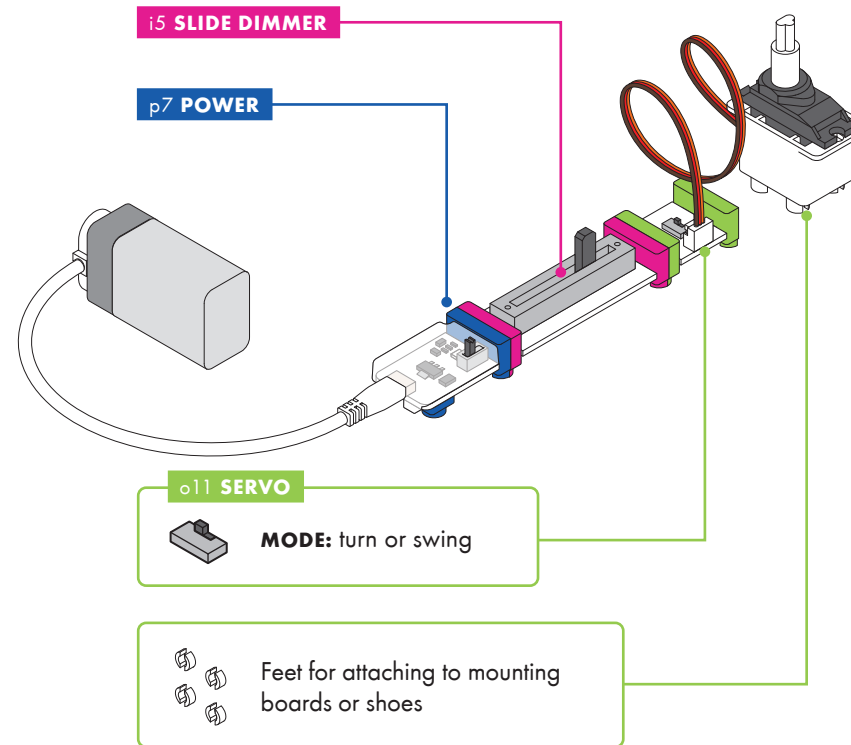

## HOW IT WORKS

The servo has two modes. In **TURN** mode, the input from other Bits determines the position of the hub - try using a dimmer to set the angle you want. In **SWING** mode, the servo will move back and forth on its own like a pair of windshield wipers - the input signal controls the speed of the swing.

The servo's range of motion is about 180 degrees.

The servo motor is contained within a servo bucket. Simply press the plastic feet into a mounting board for extra stability.

## REAL WORLD ANALOGIES



TRUCK CRANE

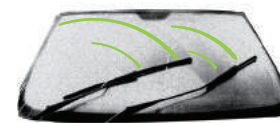

WINDSHIELD WIPERS

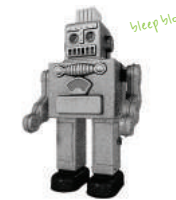

ROBOT





## o13 FAN

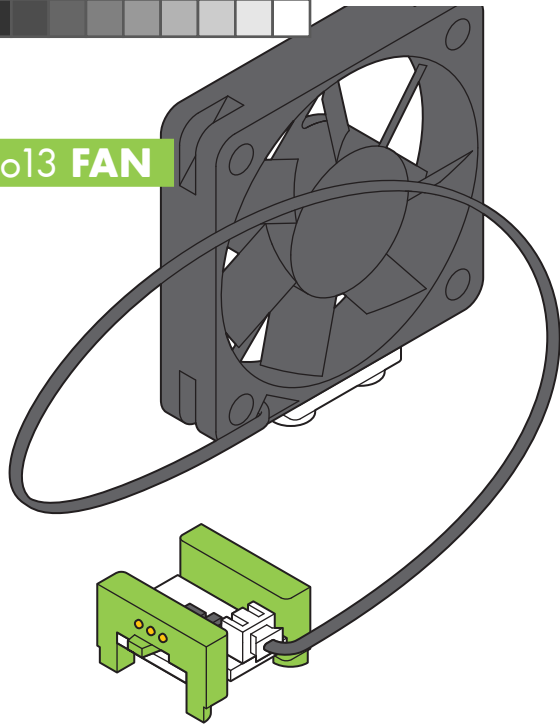

### MEET THE BIT

Use the fan to create a gentle breeze, perfect for cooling things off. You can also try taping small things (like stickers or pieces of paper) to the center of the fan for some spinning visuals.

### MINI-CHALLENGE

Can you invent something that uses the fan to move an object across the table?

## SAMPLE CIRCUIT

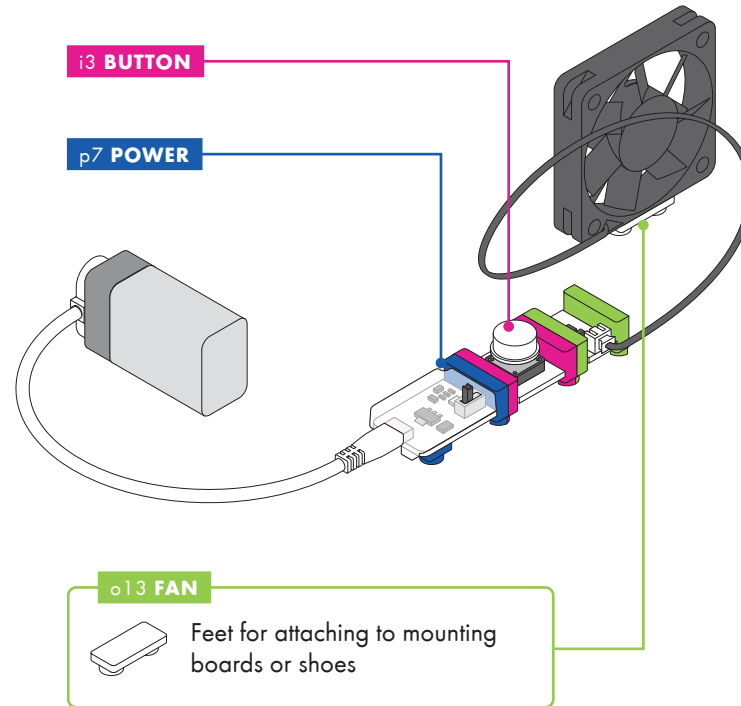

## HOW IT WORKS

Inside the fan is a tiny motor. When it receives a signal, it spins. The more signal it receives, the faster it spins.

## REAL WORLD ANALOGIES



LEAF BLOWER



PERSONAL FAN



AIRPLANE PROPELLER





## o19 RGB LED

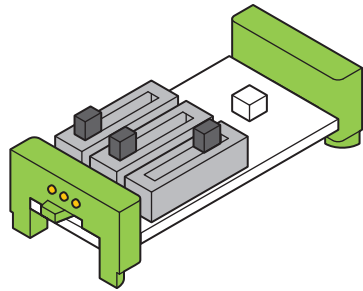

### MEET THE BIT

The RGB LED is a light with adjustable color. You can use the sliders to create your own custom color mix of red, green, and blue.

### MINI-CHALLENGE

Can you invent a flashlight that uses your favorite color?

## SAMPLE CIRCUIT

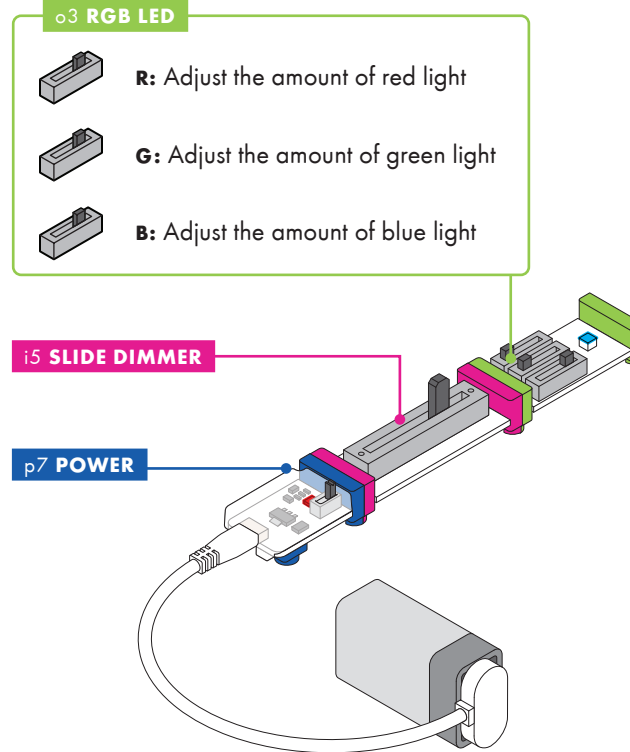

## HOW IT WORKS

The RGB LED is actually three very small lights (a red, a blue, and a green light). Moving the sliders changes the brightness of each light. The colors from these lights mix together to create every color in the rainbow.

## REAL WORLD ANALOGIES



TRAFFIC LIGHT

*Thousands of RGB LEDs create these displays*



JUMBOTRON



DECORATIVE LIGHTS



## o21 NUMBER

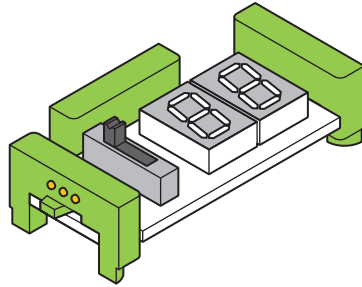

### MEET THE BIT

The number displays information that it receives from the Bits before it. It's a great way to measure the input from sensors or count things, like the score in a game.

### MINI-CHALLENGE

Can you invent a game that uses an automatic score counter?

### SAMPLE CIRCUIT

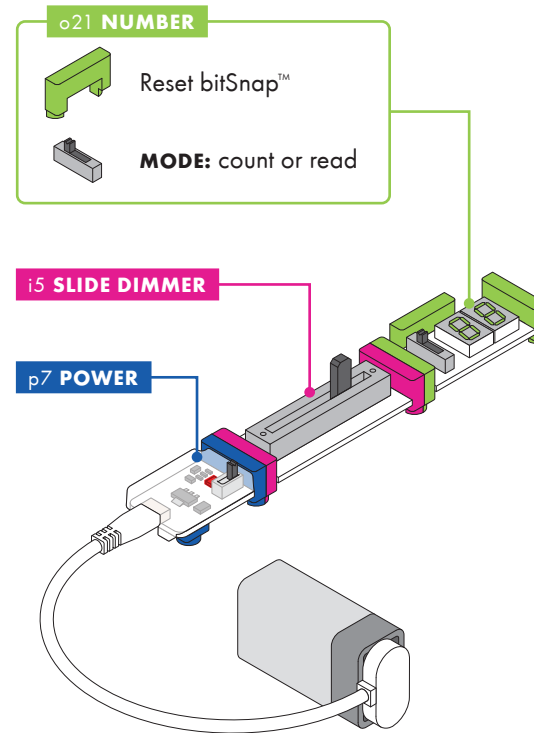

### HOW IT WORKS

The number Bit displays information about the signal it's receiving.

In **COUNT** mode, the Bit can count up or down when the Bit receives an input signal over 2.5 volts. It can be reset by receiving a signal through the reset bitSnap.

In **READ** mode, the Bit displays information about the signal it's receiving in either volts ranging from 0.0–5.0 or values ranging from 0–99.

The signal leaving the Bit will always match the number being displayed, even in **COUNT** mode. For example, if you count up to 38, the signal leaving the Bit will be 38% of full power.

### REAL WORLD ANALOGIES



SCOREBOARD



VOLUME INDICATOR ON TV

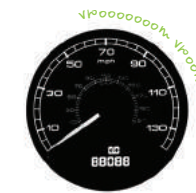

SPEEDOMETER



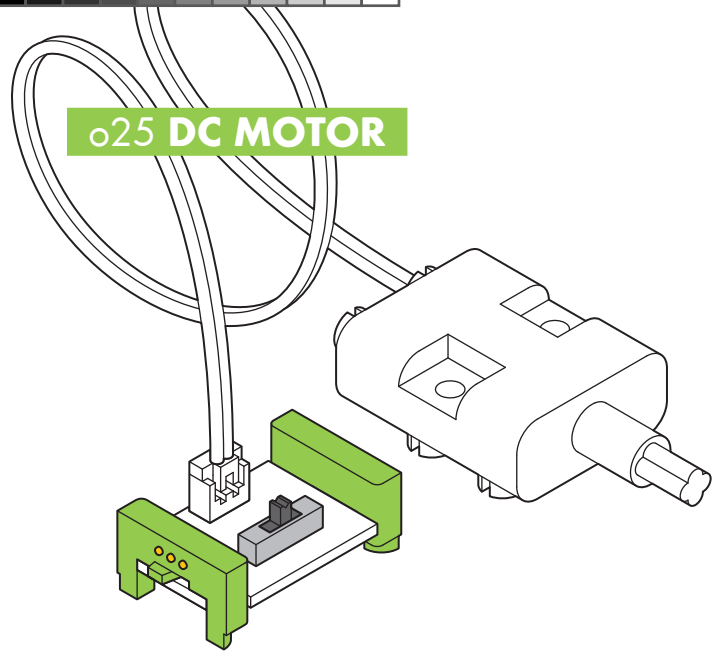

### o25 DC MOTOR

#### MEET THE BIT

Use the motor to spin, turn, twist, and roll.

There are a few accessories you can use with the DC motor (like wheels). You can find out how to use those on pages 25-26.

#### MINI-CHALLENGE

Can you invent something using the DC motor that travels across the table?

#### SAMPLE CIRCUIT

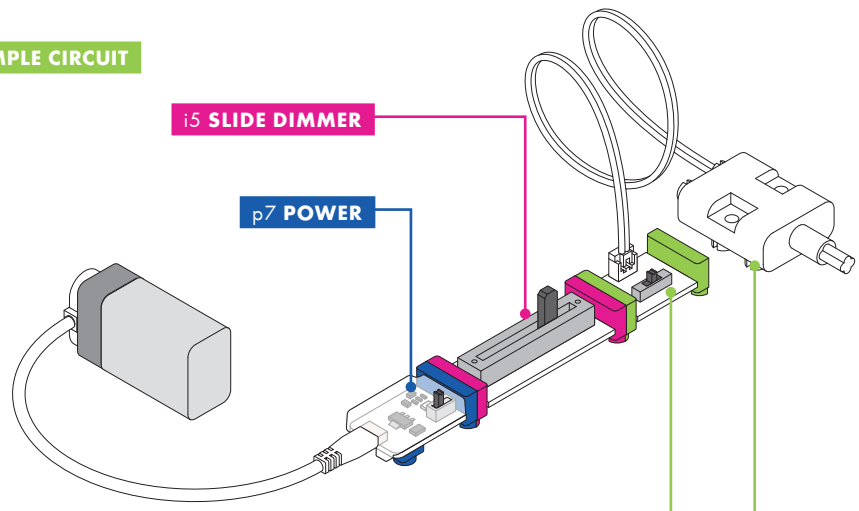

i5 SLIDE DIMMER

p7 POWER

o25 DC MOTOR

**MODE:** CW (clockwise), VAR (variable mode), and CCW (counterclockwise)

Feet for attaching to mounting boards or shoes

#### HOW IT WORKS

The DC (or "direct current") motor rotates a shaft when it receives a signal. The more signal it receives, the faster the motor will spin.

A switch on the board lets you choose which direction the motor spins. **CW** spins clockwise and **CCW** spins counterclockwise. When the switch is in **VAR** (variable) mode, the amount of signal the motor receives from previous Bits allows you to control the speed and direction (clockwise or counterclockwise) of its motion. In this mode, using an input like a slide dimmer makes steering easy!

#### REAL WORLD ANALOGIES



CAR ENGINE



DRILL



FERRIS WHEEL

yahooooo



## a5 MAGNET SHOES

## a6 HOOK & LOOP SHOES

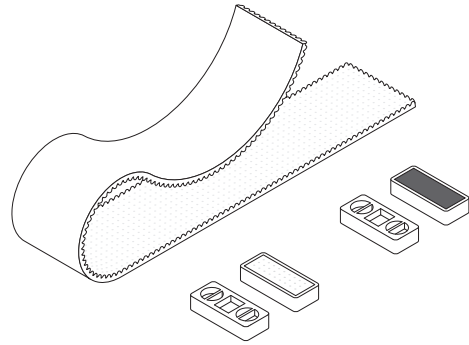

### MEET THE ACCESSORY

Shoes slip onto your Bits' feet and hold your circuit together. On the bottom of your shoes you'll find magnets or hook & loops, which are great for securing your circuits to different surfaces.

### HOW IT WORKS

First, snap together your littleBits circuit. Then press the feet of your Bits into the holes of the shoes and place it on your chosen surface.

Magnet shoes allow you to adhere your circuit to any magnetic surface. Try your refrigerator or your locker!

Hook & loop shoes come with an adhesive-backed hook & loop strip. The strip can be cut to any size you desire and affixed to clothing, fabric, or any flexible surface.

bitFeet™ go in the shoes

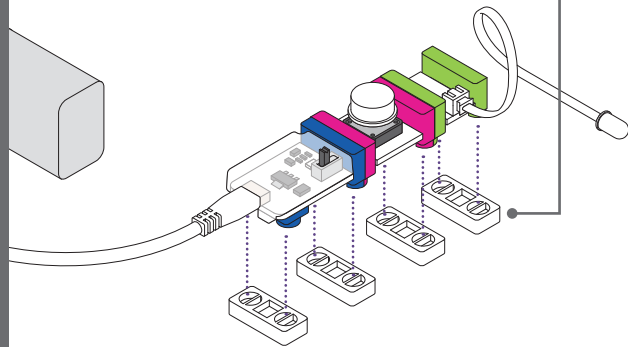

## a30 MOUNTING BOARD

### MEET THE ACCESSORY

The mounting board is like the backbone of some of your inventions. It allows you to keep your circuit intact and move it around with ease! It also provides structure which is helpful for building out projects, like a vehicle.

### HOW IT WORKS

Snap together your littleBits circuit and press the feet of your Bits into the holes of the mounting board.

**NOTE:** Your circuit must be complete before you press it onto the board. You won't be able to add Bits one at a time.

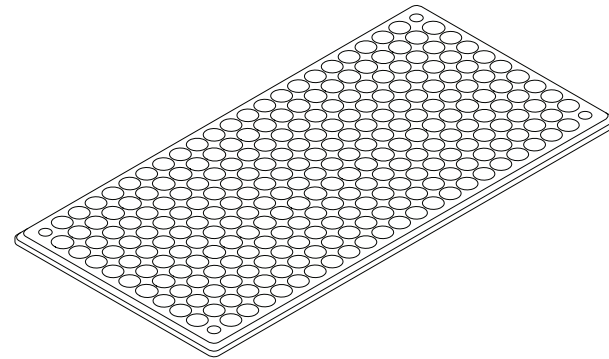

! PRESS DOWN ON BITSNAPS NOT WHITE CIRCUIT BOARD.

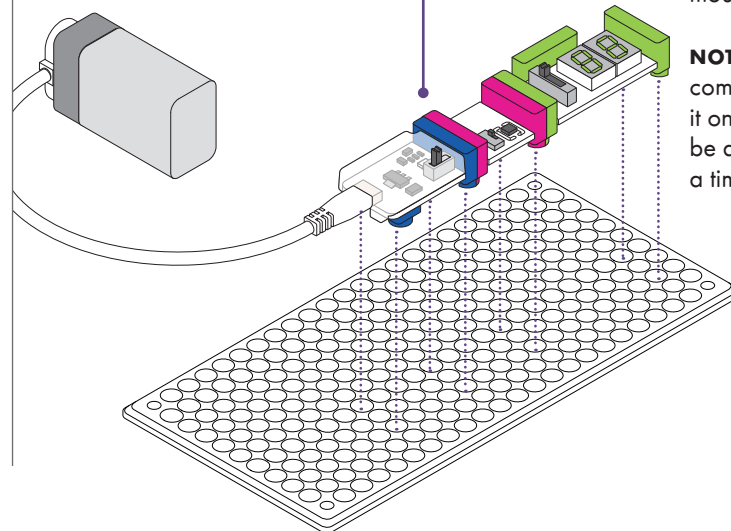



## a10 MOTORMATE

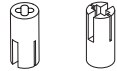

### MEET THE ACCESSORY

The motorMate makes it easy to attach paper, cardboard, axles like LEGO® axles, and lots of other materials to the DC motor.

### HOW IT WORKS

To mount, align the cross hole of the motorMate with the cross shaft of the DC motor and press together. On the other end, the motorMate has two different sized slots: one fits most standard craft sticks and the other fits thicker papers like cardstock. Axles like LEGO® axles fit right into the center.

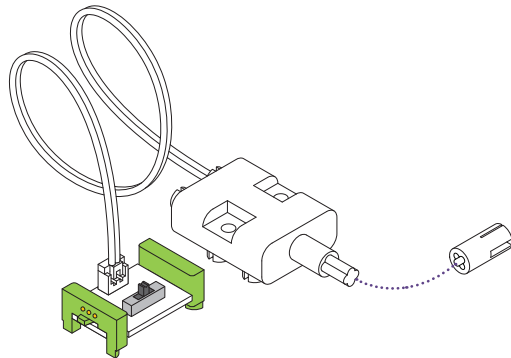

## USB CABLE

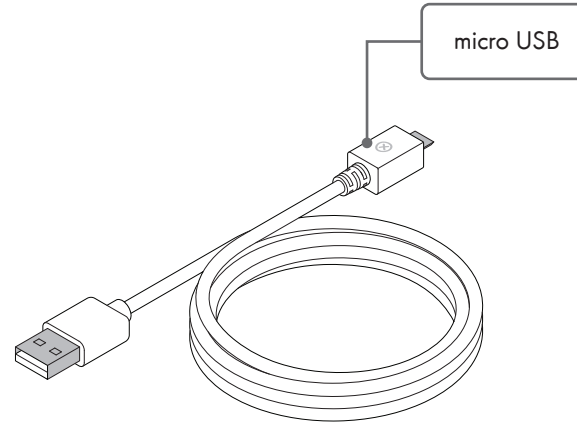

### MEET THE ACCESSORY

The USB cable brings power to your USB power Bit and rechargeable battery. It will also send information between certain Bits and your computer. The cable comes in two lengths, 1'7" (0.5m) and 4'11" (1.5m), to fit your needs.

### HOW IT WORKS

Simply connect the cable from a power source to your littleBits USB power Bit (this only connects to the p3 USB power Bit). You can use the USB cable to power your circuits from a computer, power adapter, or rechargeable USB battery.







## a25 WHEEL

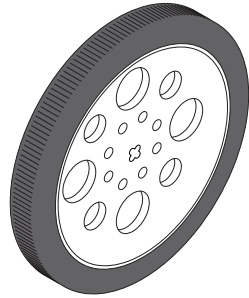

### MEET THE ACCESSORY

When used with a DC motor, this wheel is perfect for making bots, cars, and all sorts of spinning inventions.

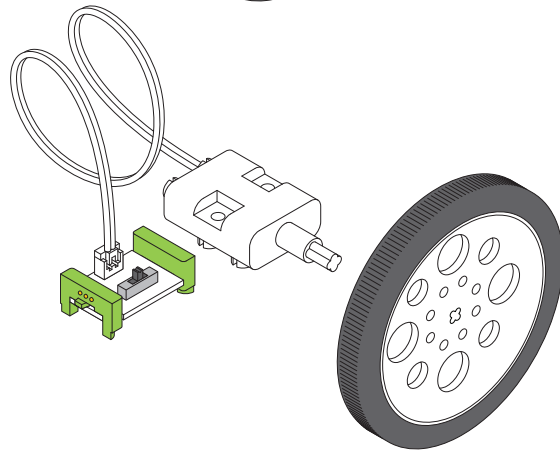

### HOW IT WORKS

To attach the wheel to the DC motor shaft, align the cross hole in the wheel with the cross of the motor shaft. Press firmly together.

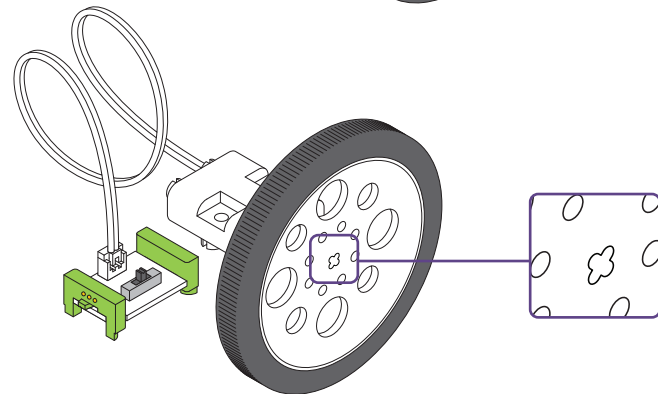

## a23 MECHANICAL ARM

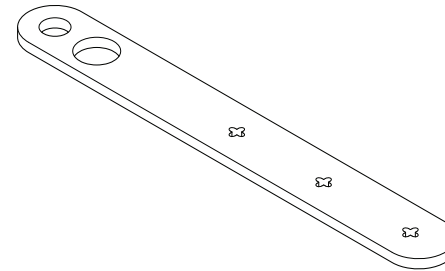

### MEET THE ACCESSORY

The mechanical arm attaches to both the servo and the DC motor shaft, and offers lots of leverage for pushing, pulling, and throwing.

### HOW IT WORKS

To attach the mechanical arm to the DC motor, line up the DC motor cross shaft with one of the cross holes in the mechanical arm.

For the servo, line up the T shaft with one of the cross holes in the mechanical arm and press firmly.

The two large holes on the end are perfect for holding pens and markers in place.

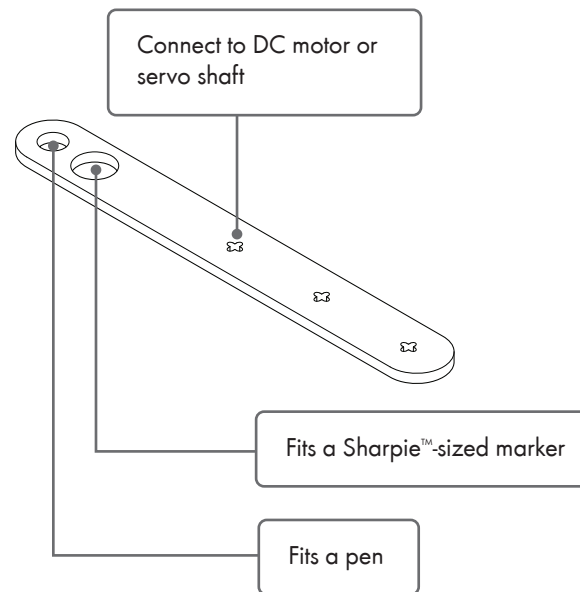



## a31 BATTERY MOUNT

### MEET THE ACCESSORY

The battery mount secures the 9-volt battery to the mounting board.

### HOW IT WORKS

Slide the 9-volt battery into the opening of the battery mount and press the feet of the battery mount into the mounting board.

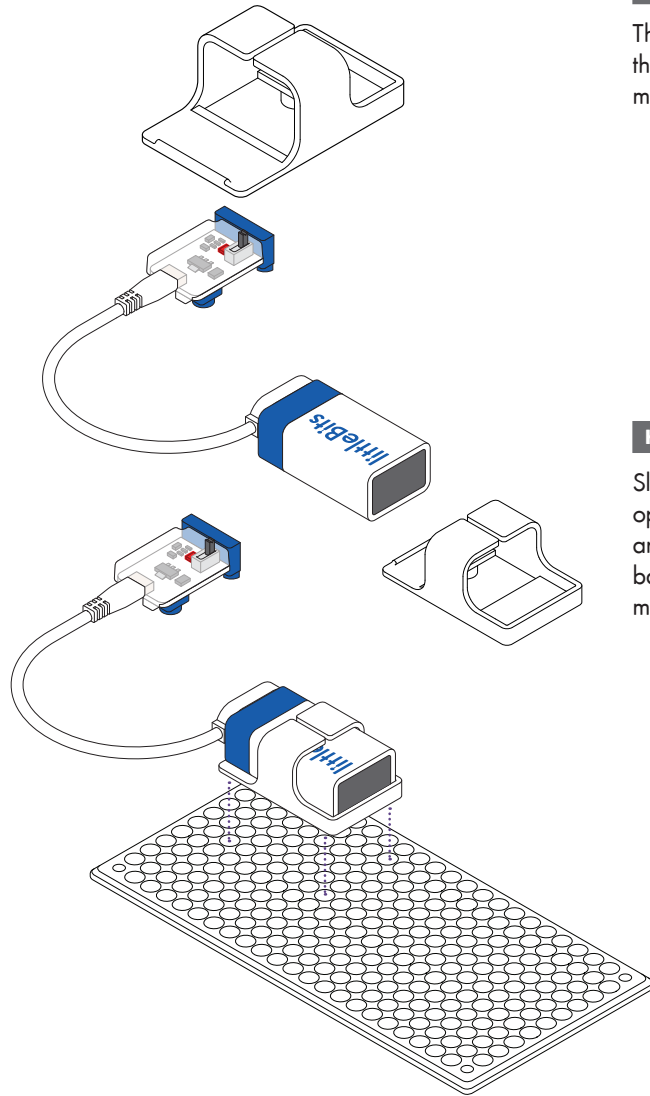



# THE LITTLEBITS™ INVENTION CYCLE

What is the Invention Cycle?  
The Invention Cycle is a roadmap for your invention journey. Each phase is full of activities and questions that help you explore your ideas and develop your invention.

## DO I HAVE TO GO THROUGH THE INVENTION CYCLE EXACTLY IN ORDER?

Nope! If you want, you can remix while you play or share while you create. Each phase of the invention cycle represents a different way of thinking and making. They work well in order, but a good design process is always a bit messy.

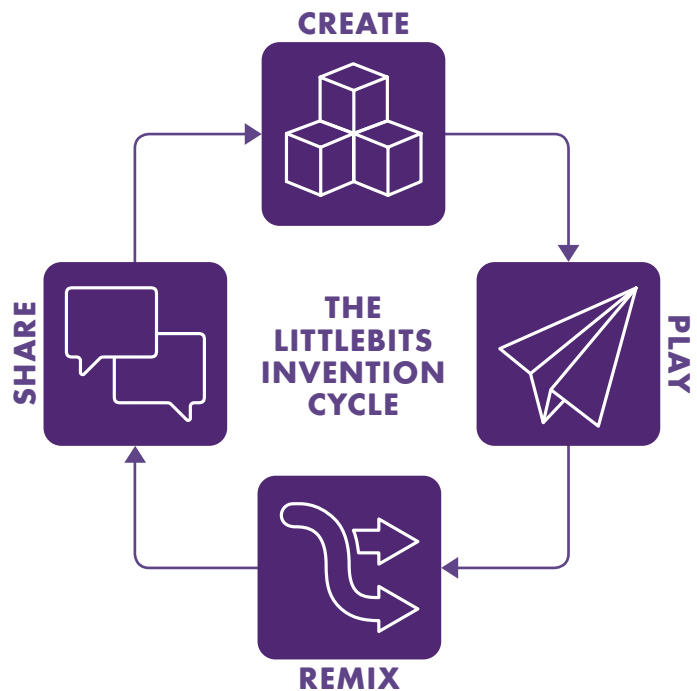

**CREATE**

**PUT SOMETHING TOGETHER.** You can build it from the instructions or make something from your imagination. Don't worry if it doesn't work or if it isn't perfect. The important thing is to create your first model so you have something to experiment with.

**REMIX**

**IMPROVE YOUR INVENTION.** Keep experimenting! Add new Bits, swap parts with other inventions, or take all the pieces apart and put them together in a different way.

**PLAY!**

**USE IT!** Playing with what you've created is fun, but also an important part of inventing. Playing is like a test run. It's a chance to see how well your invention works and look for ways you can make it better.

**SHARE**

**INSPIRE OTHERS.** Show the world what you've created online at littleBits Education. Get inspired by exploring what others have shared. Create, play with, and remix other inventions. This is how awesome new inventions are born.

**ICON INDEX**



**POWER ON/OFF**  
The p4 power Bit™ has an on/off switch. This icon will let you know when it's time to turn it on or off.



**PRO TIPS**  
Keep your eyes open for these bits of littleBits wisdom. These tips will help build your invention skills and level up your inventions.



**USE RUBBER BAND OR MASKING TAPE**  
This icon will tell you when to use rubber bands or some masking tape to keep something in place.



**CHANGE MODE**  
Some Bits have a switch that changes how the Bit works. This icon will tell you which mode your switch should be in.



**TEST YOUR CIRCUIT**  
Before you play with your new invention, you'll turn the power on and make sure all your Bits™ are doing their jobs.



**EXTRA IMPORTANT INFO!**  
This icon will let you know when there is a small, but very important step we don't want you to miss. If you ignore these your invention won't work.



**LITTLEBITS CLASSROOM**  
Discover inventions and easily upload and share your own creations.



# PROTOTYPING TIPS

**WHAT'S A PROTOTYPE, YOU ASK?** A prototype is a model that helps you test an idea. This is the first step in turning your ideas into actual inventions. Building a prototype helps you learn what you like, what works, and what needs more figuring out. You'll be building a lot of prototypes during the challenges in this booklet.

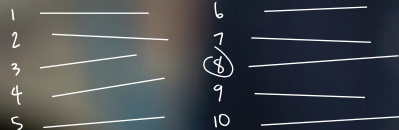

## **DON'T WORRY ABOUT PERFECTION**

or if your invention will work right away – just start making. Do you think the light bulb was invented on the first try? Most inventions take many tries to get right.



## **BUILD MANY DIFFERENT VERSIONS.**

The more you experiment, the more you will learn, and the better your invention will be.



## **TRY SOME WEIRD AND UNEXPECTED STUFF.**

You might be surprised at what you discover when you add random materials, flip your prototype upside down, or try using it for a totally different purpose.



**DOCUMENT EACH STEP.** As your prototype changes, take photos, draw sketches, and jot down notes. The journey from idea to invention is just as exciting and important as the final result. You did a lot of work to bring it to life. Show it proudly!



# HELPFUL TOOLS & MATERIALS

**THE WORLD AROUND YOU IS FULL OF MATERIALS FOR PROTOTYPING AND CREATING INVENTIONS.** At littleBits, we dig through our recycling bins all the time to collect stuff for our projects. In fact, the very first prototype of a Bit was made with cardboard, copper tape, and a few electronic components like LEDs. Here's some of our favorite stuff to work with:

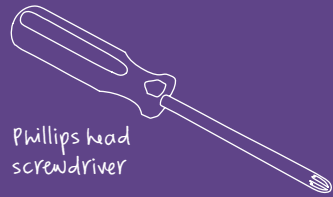

Phillips head screwdriver

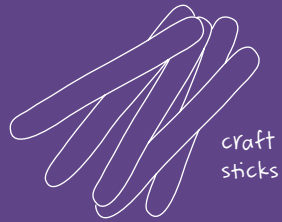

craft sticks



string



paper or plastic cups



scissors

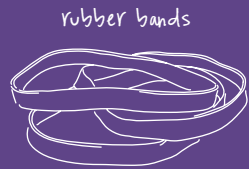

rubber bands

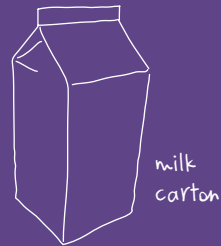

milk carton

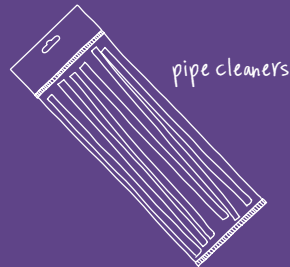

pipe cleaners



markers

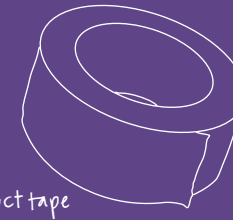

duct tape



cereal box

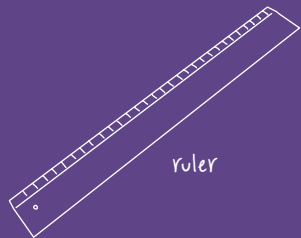

ruler

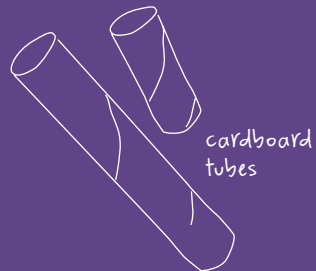

cardboard tubes

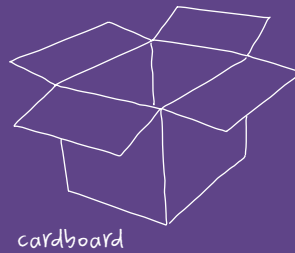

cardboard



plastic bottle

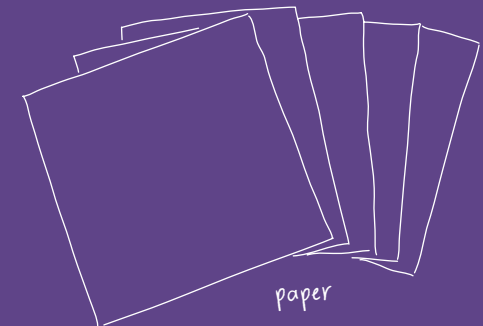

paper





CHALLENGE 01

# INVENT A SELF-DRIVING VEHICLE

**30**  
MINUTES  
(MINIMUM)

TIME

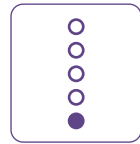

LEVEL

**START BY BUILDING THE CIRCUIT CRUISER, A VEHICLE THAT GETS AROUND ON TWO DC MOTORS.** Add extra features to this lean, mean, mobile machine. Use it to deliver school supplies to your friends, help your teacher pass out papers, or wake up your sleeping classmate.



## BITS™ + MATERIALS

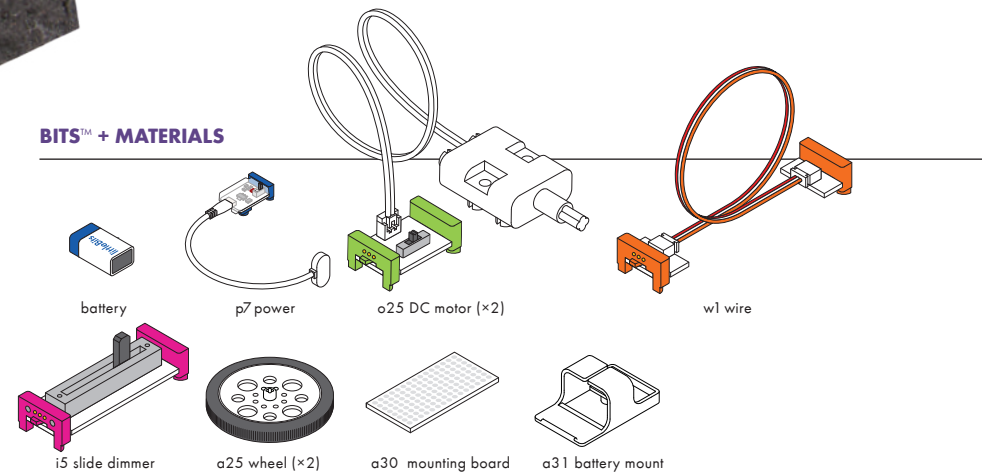



# CREATE

BUILD YOUR CIRCUIT.

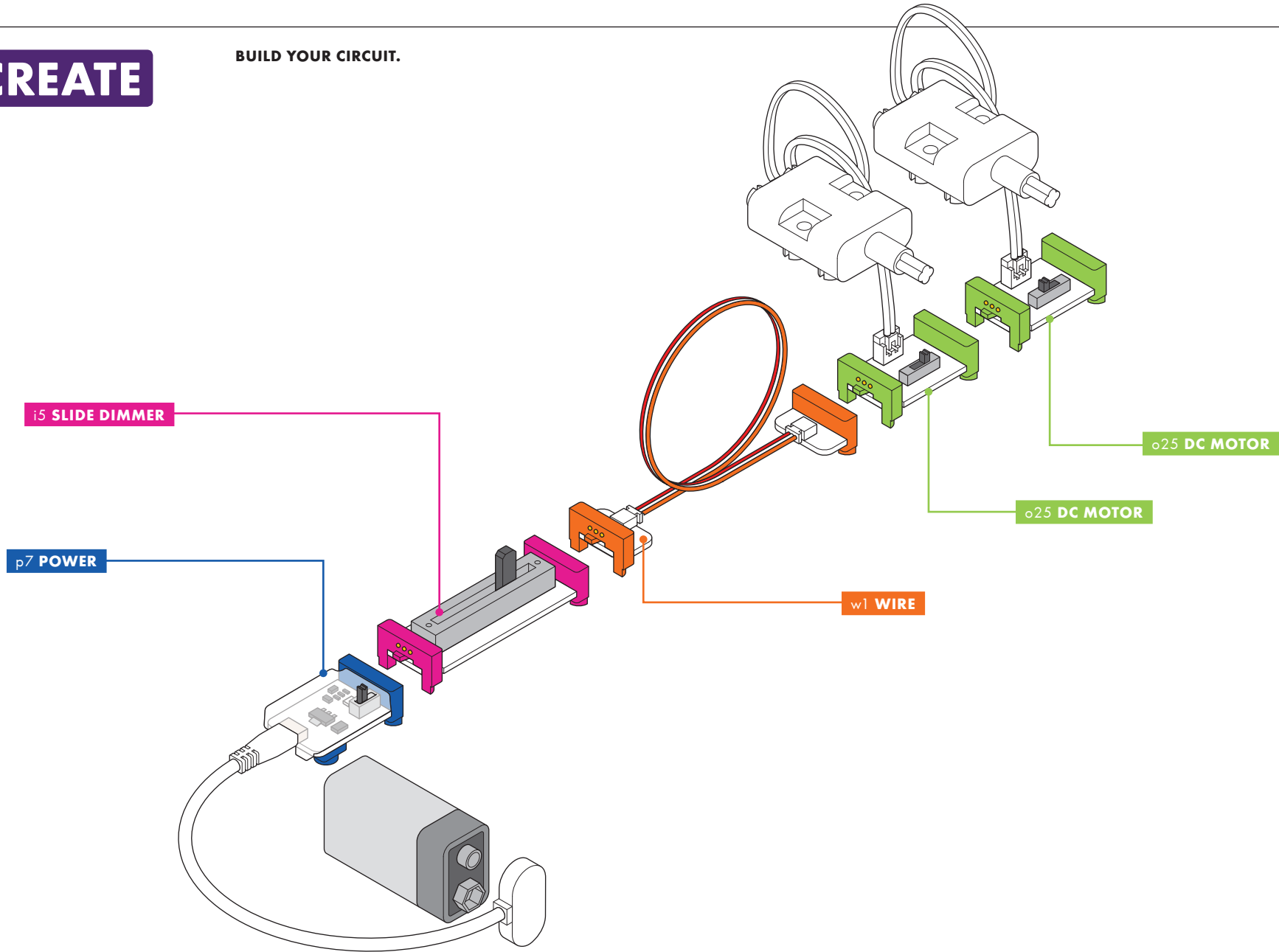



**PRESS THE WHEELS ONTO THE DC MOTORS.**

**PRESS YOUR CIRCUIT ONTO THE MOUNTING BOARD.**

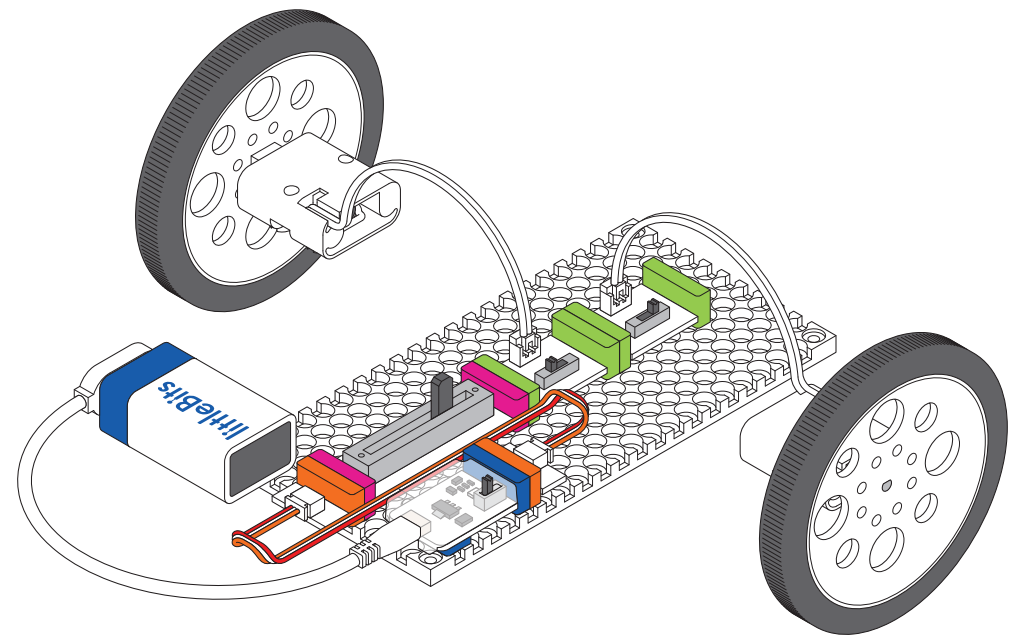
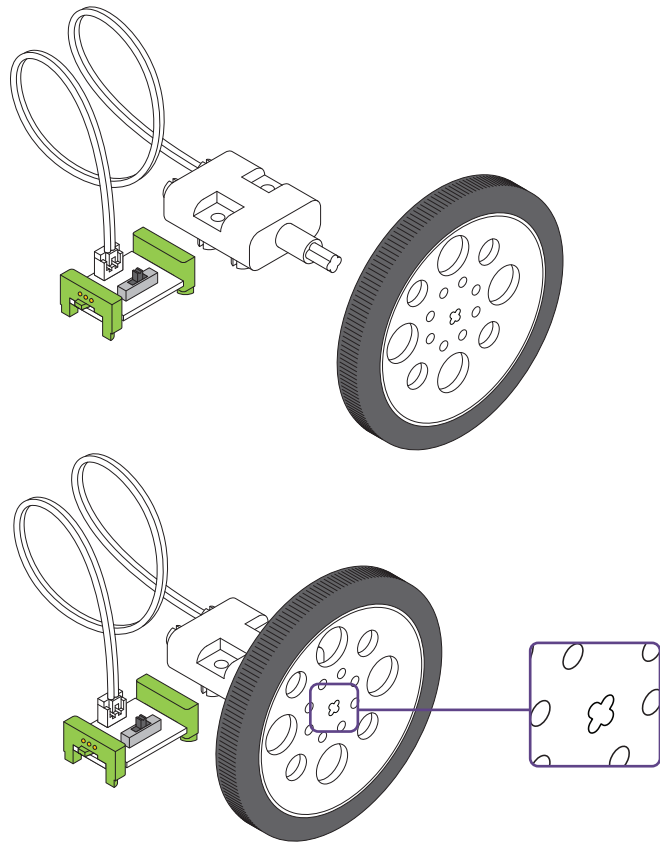



**SLIDE THE BATTERY INTO THE BATTERY MOUNT AND ATTACH IT TO THE MOUNTING BOARD.**

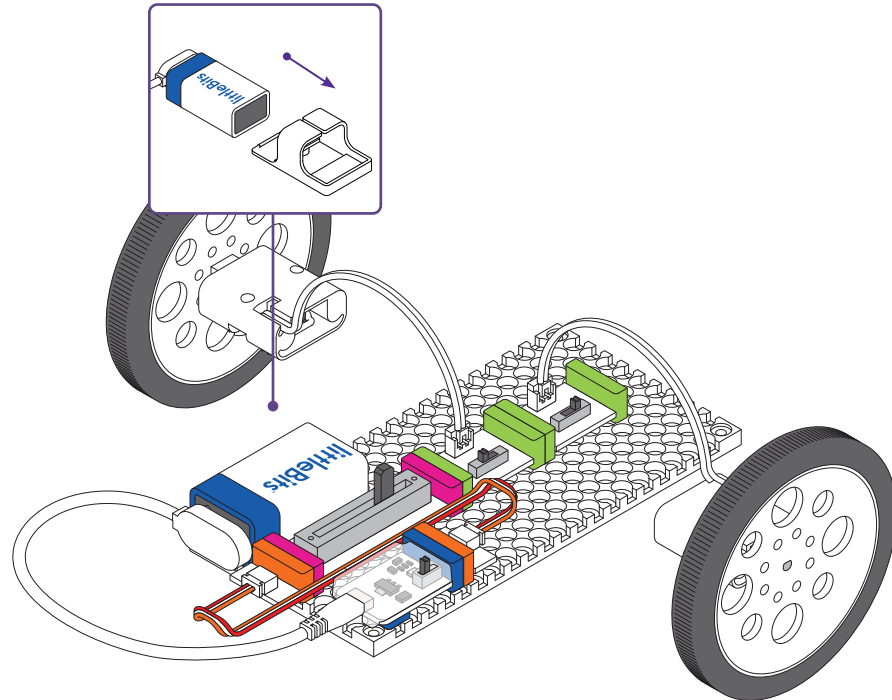

**PRESS THE MOTORS ONTO EITHER SIDE OF THE MOUNTING BOARD.**

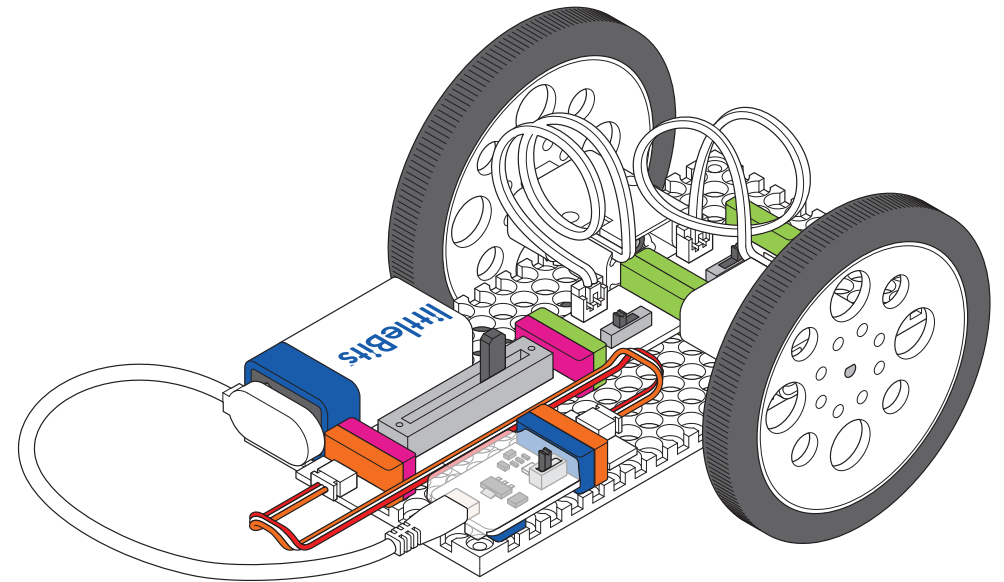





**SET THE FIRST DC MOTOR TO CCW (COUNTERCLOCKWISE) AND THE SECOND DC MOTOR TO CW (CLOCKWISE).**

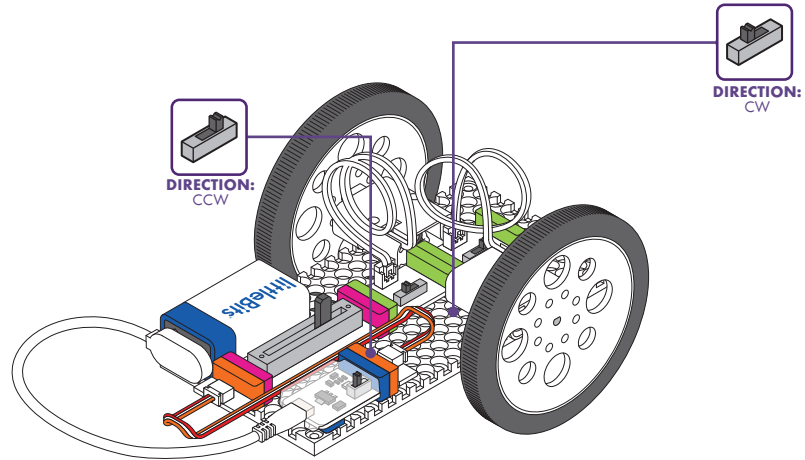

**TEST YOUR CIRCUIT.** With the slide dimmer set all the way up, the car should move forward. Troubleshooting pg 71.

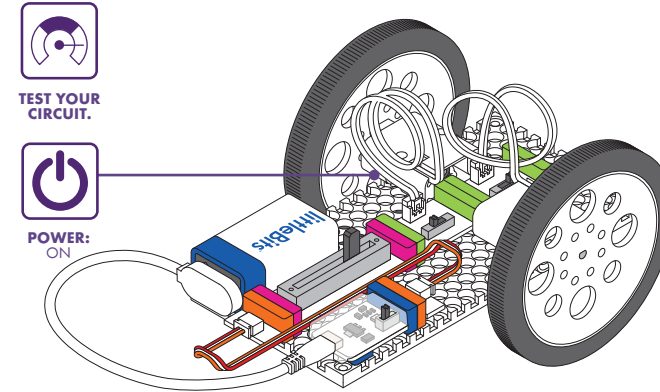

 **PLAY!**

Let's give these wheels a spin!



# HOW IT WORKS

## o25 DC MOTOR



Control the direction your car drives by flipping the mode switches. Because the motors face opposite directions, they need to be set in opposite spin modes to drive in one direction. Setting the motors to the same direction mode will create a car that spins around in circles.

## i5 SLIDE DIMMER

The slide dimmer is like the gas pedal for your car. As you slide it up, more power goes to your motors.

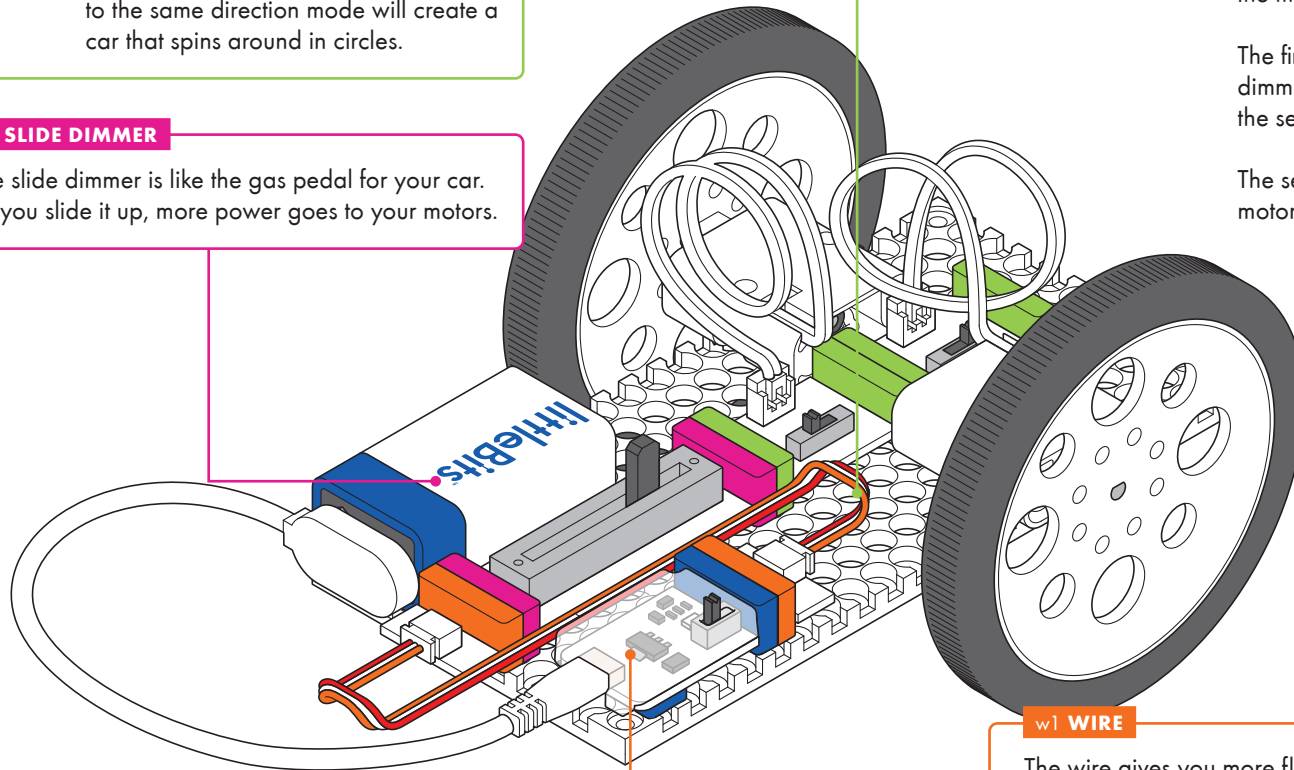

## w1 WIRE

The wire gives you more flexibility in how you position your Bits on the board.

p7 POWER sends a signal through the circuit.

The w1 WIRE receives the signal from the power and sends it along to the slide dimmer.

The i5 SLIDE DIMMER controls how much power goes to the motors.

The first o25 DC MOTOR uses the signal from the slide dimmer to determine its speed. It then passes this signal onto the second motor.

The second o25 DC MOTOR reads the signal from the first motor and also uses it to determine its speed.





## REMIX

HOW CAN YOU LEVEL-UP YOUR CAR? LET'S EXPERIMENT!

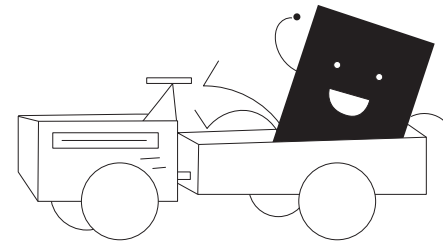
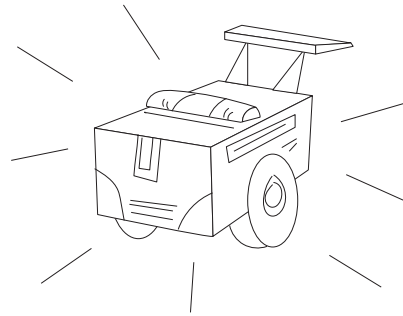
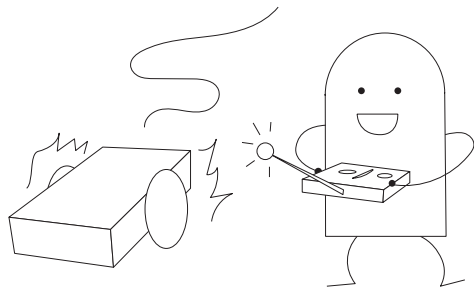

### A CHANGE HOW YOU CONTROL THE CAR.

- Use inputs other than the slide dimmer. Try a light sensor you control with a flashlight, or string two wires together with a button to have a "remote" control.

### B SUPE IT UP!

- Add a siren using lights or the buzzer, or a speedometer using the number Bit™.
- Give your vehicle a body or form. Give it some character!
- Use building blocks like LEGO® bricks to build a bigger car or even a train.

### C BUILD A TRAILER FOR YOUR VEHICLE USING MATERIALS AROUND YOU.

- How much stuff can your vehicle haul?

## SHARE



**HOST A CAR SHOW!** Present the best features of the car you made. Let others test drive it.

**ASK YOUR FRIENDS WHAT THEY WOULD USE YOUR VEHICLE FOR** – sending messages, passing snacks, borrowing pencils – and show them how it could accomplish that function.



SHARE YOUR INVENTIONS ONLINE AT LITTLEBITS CLASSROOM





CHALLENGE 02

# INVENT AN ART MACHINE

**30**  
MINUTES  
(MINIMUM)

TIME



LEVEL

**START BY CREATING A DOODLE WIZARD** – a bot made with DC motors, and a pulse that dances, wiggles, and draws up a storm. Add your own artistic flair by changing up some of the Bits and materials to create unique masterpieces.

## BITS™ + MATERIALS



battery

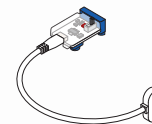

p7 power

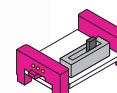

i16 pulse

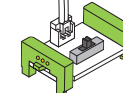

o25 DC motor (x2)

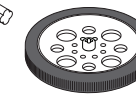

a25 wheel (x2)

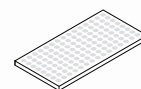

a30 mounting board

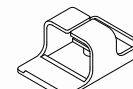

a31 battery mount

• markers  
• drawing surface  
• rubber band/  
masking tape  
(not included)



# CREATE

BUILD YOUR CIRCUIT.

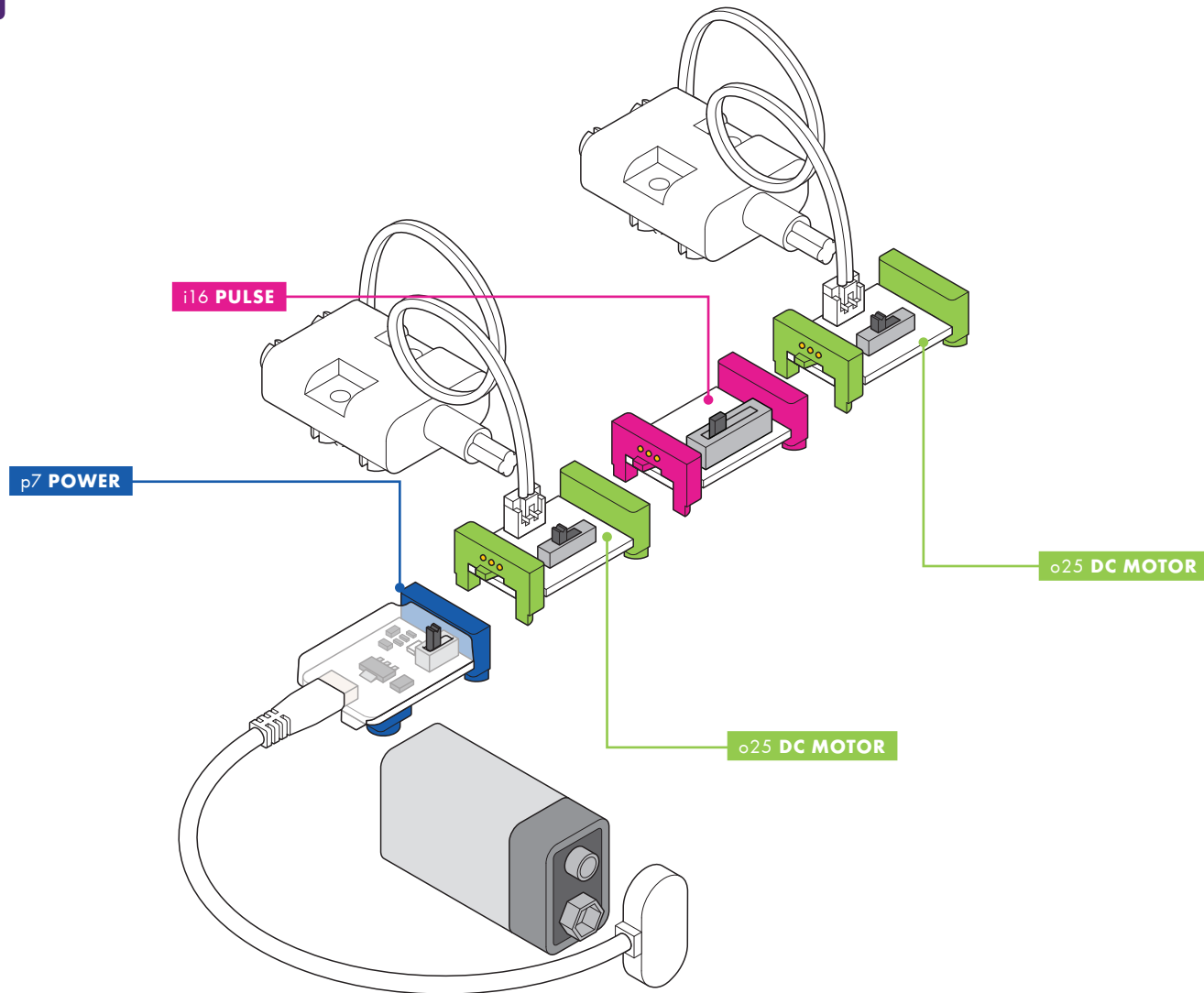



**PRESS THE WHEELS ONTO THE DC MOTORS.**

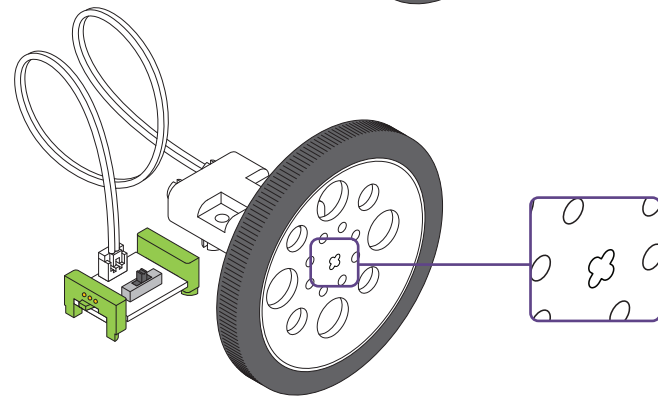
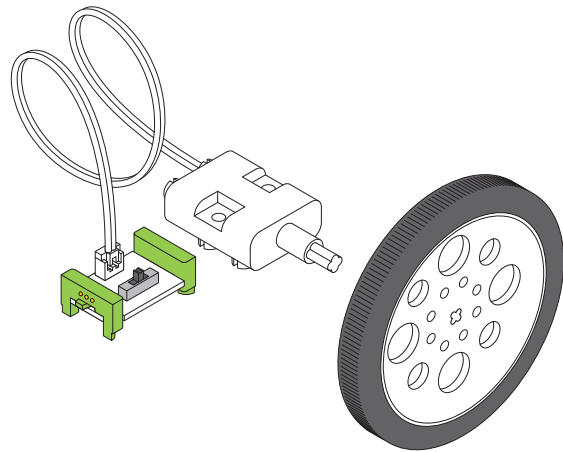

**PRESS YOUR CIRCUIT ONTO THE MOUNTING BOARD.**

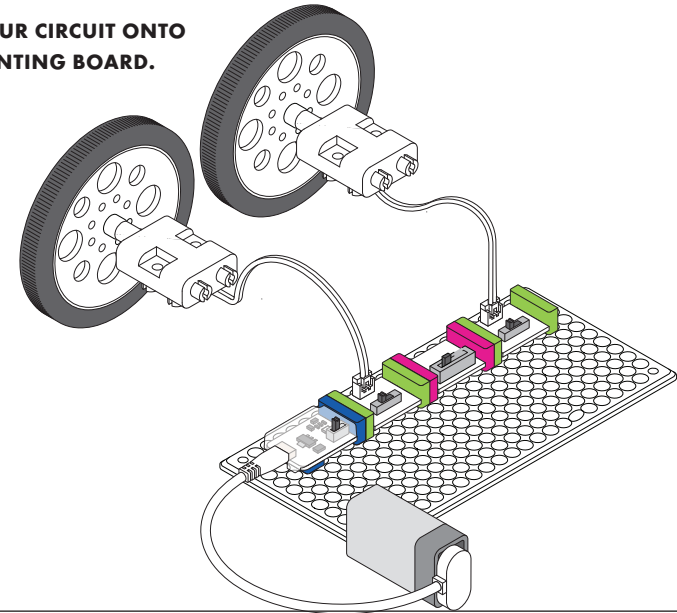

**SLIDE THE BATTERY INTO THE BATTERY MOUNT AND ATTACH IT TO THE BACK OF THE MOUNTING BOARD.**

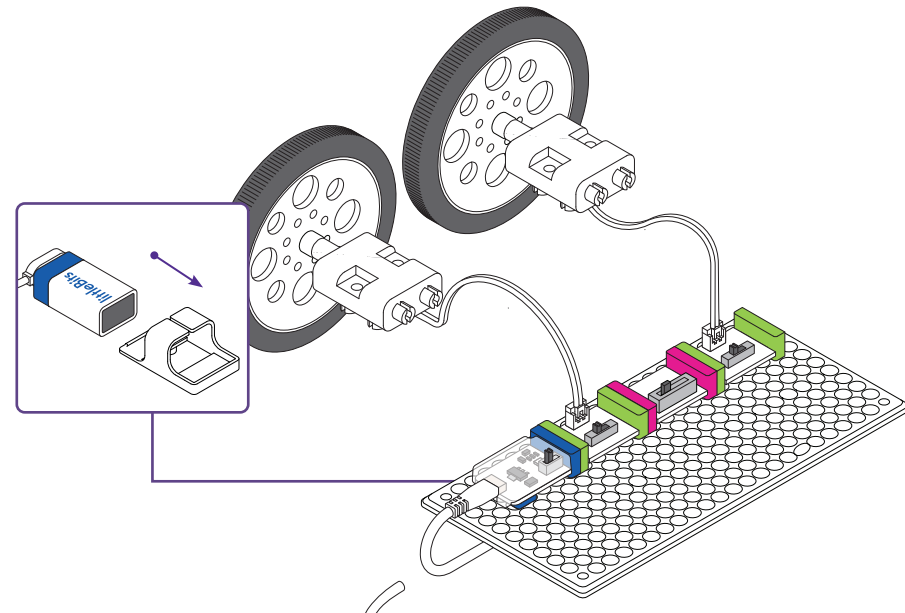



**ATTACH MOTORS TO THE MOUNTING BOARD.**

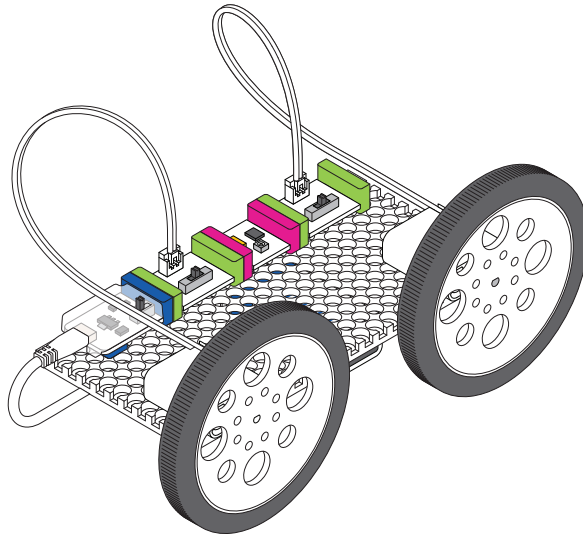

**SET THE PULSE SPEED TO THE SLOWEST SETTING.**

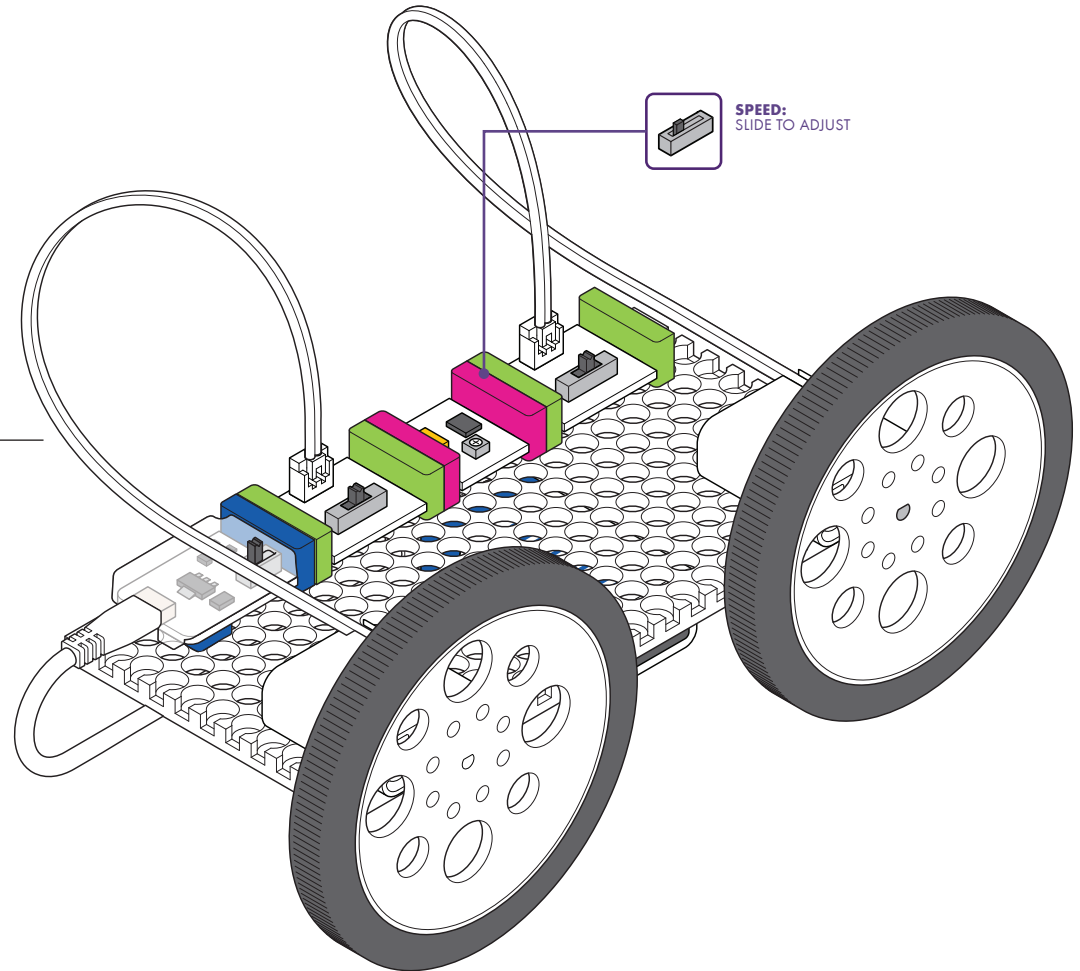

**ADJUST BOTH MOTOR MODES TO CCW (COUNTER CLOCKWISE).**

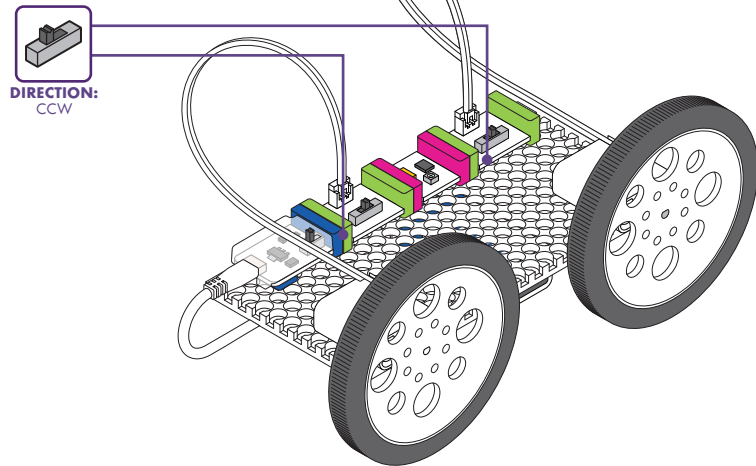





### ATTACH THE MARKER.

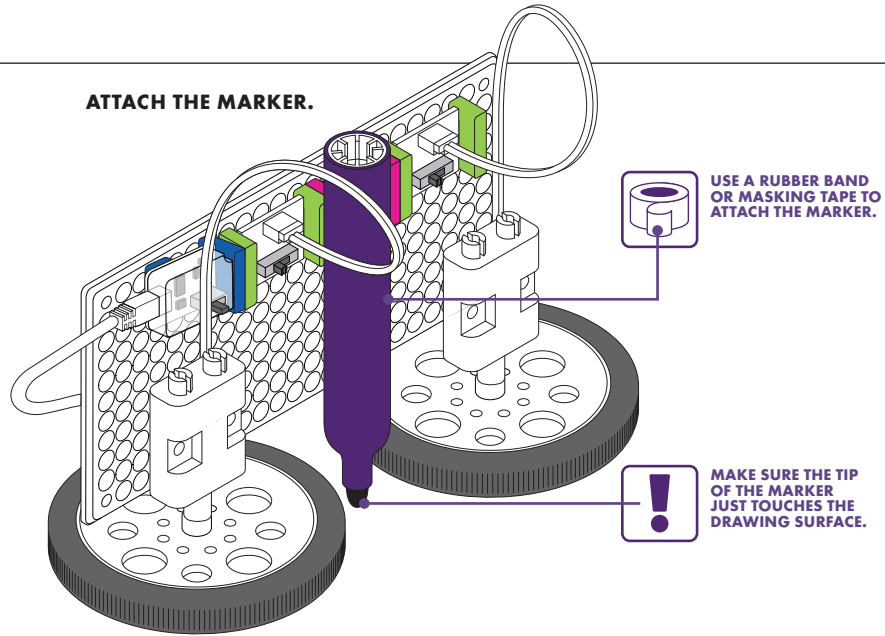

**TEST YOUR CIRCUIT.** When you turn the power on, one wheel should spin all the time while the other one alternates between spinning and stopping. Troubleshooting pg 71.

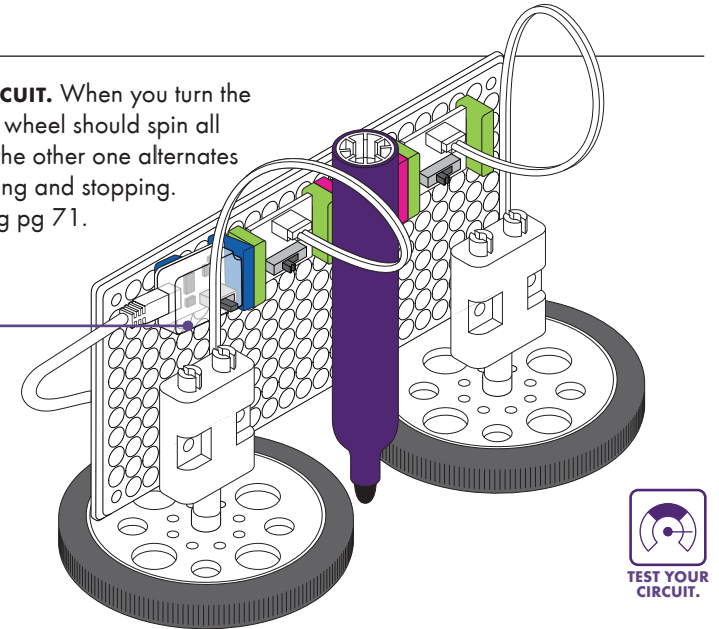

 **PLAY!**

Now let's make some art!  
Make a series of drawings,  
and pick a few of  
your favorites.



# HOW IT WORKS

## i16 PULSE



The speed slider controls how fast the pulse flips on and off. Adjusting it will change how often and how long the second motor spins.

## p7 POWER

sends a signal through the circuit.

The first **o25 DC MOTOR** receives that signal and spins at full speed in one direction.

The signal passes through the motor and on to the **i16 PULSE**. The pulse only lets the signal through in short bursts.

When the second **o25 DC MOTOR** gets a signal from the pulse, it spins, but when the pulse switches off, the motor stops.

## o25 DC MOTOR



This switch controls which direction the motor spins. Changing the direction of the spin will change how the Doodle Wizard moves.

## o25 WHEEL

Your Doodle Wizard's movement is caused by friction between the wheels and the drawing surface. The motion of your Doodle Wizard will change if it is placed on different types of drawing surfaces (e.g. rough paper, glossy paper, or a whiteboard). You could also experiment with adding different materials to the face of the wheels and see how changes in friction change your drawings.



## REMIX

WHAT ELSE CAN YOUR INVENTION DO? LET'S EXPERIMENT!

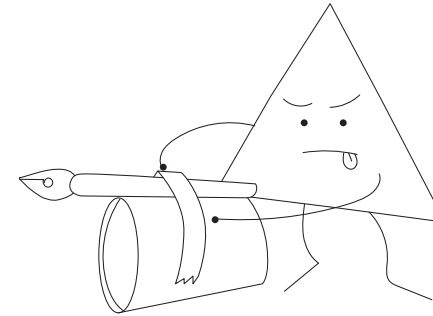
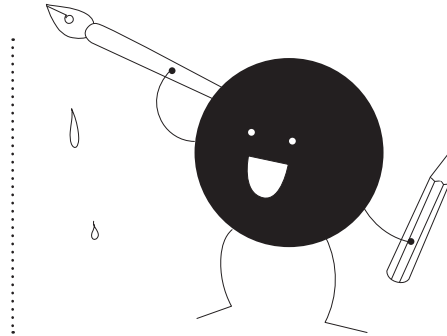
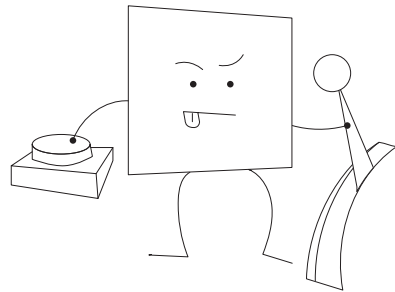

## SHARE



### A ADJUST THE BITS TO CREATE YOUR OWN UNIQUE DRAWING STYLE.

- How does changing the speed of the pulse or the direction that the motors spin make your drawings different?
- Which adjustments make your favorite drawings?

### B WHAT OTHER MATERIALS CAN YOU USE?

- Use different drawing tools, like chalk, crayons, pens, or pencils.
- Attach multiple drawing tools to use at once.
- Try the Doodle Wizard on different drawing surfaces.

### C TRY ADDING NEW BITS.

- What happens when you use a servo to draw?
- What happens when you add or swap an input?

**SET UP A GALLERY SHOW.** Present your art alongside your Doodle Wizard.

**SEE IF YOUR AUDIENCE CAN GUESS WHICH BITS YOU USED, JUST BY LOOKING AT YOUR DRAWINGS.** Challenge them to invent a machine to recreate your masterpiece.



SHARE YOUR INVENTION AT LITTLEBITS CLASSROOM



### CHALLENGE 03

# INVENT A THROWING ARM

**START BY BUILDING A LAUNCHER THAT FLINGS PROJECTILES WITH A SERVO AT THE PRESS OF A BUTTON.**

Set up a tower of cups and try to knock them over. Then modify your launcher to make it even more accurate, powerful, or speedy. Challenge your friends to see who can knock over the most cups.

**1**  
HOUR  
(MINIMUM)

**LEVEL**

○  
○  
○  
●



### BITS™ + MATERIALS



battery

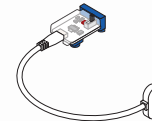

p7 power

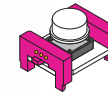

i3 button

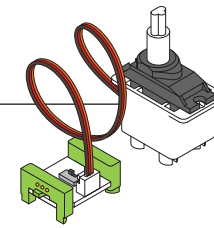

o11 servo

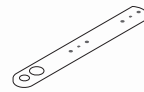

a23 mechanical arm

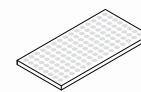

a30 mounting board

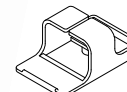

a31 battery mount

- scissors
- rubber band
- paper cups
- masking tape

(not included)





# CREATE

BUILD YOUR CIRCUIT.

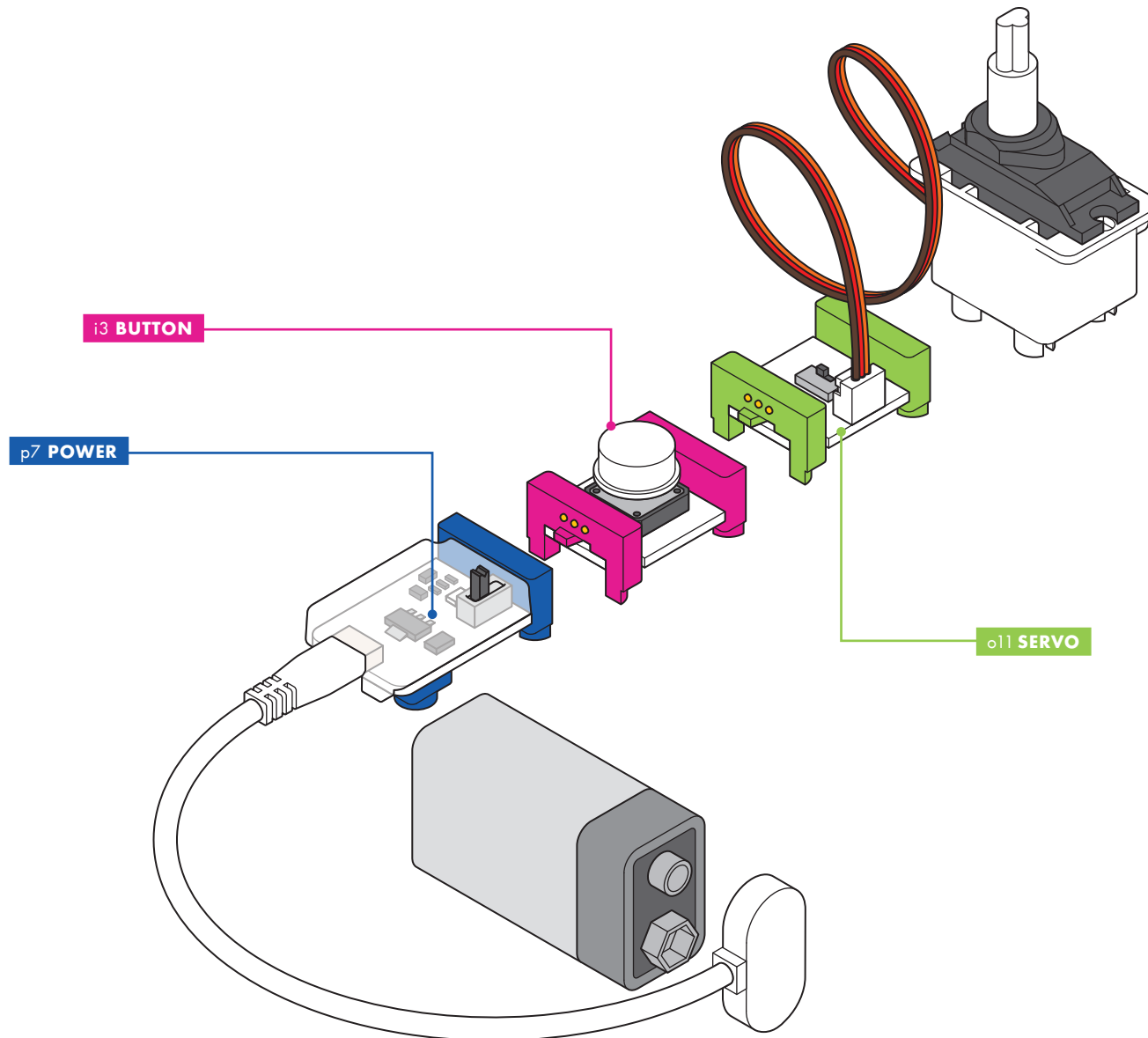



**PRESS YOUR CIRCUIT ONTO THE MOUNTING BOARD.**

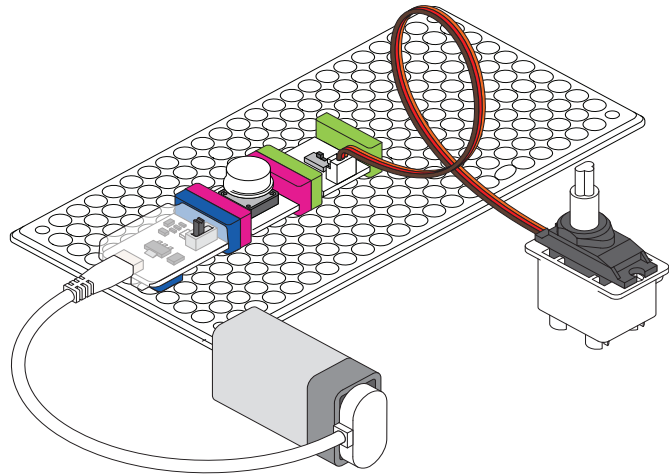

**PRESS THE SERVO MOUNT ONTO THE MOUNTING BOARD AND ADJUST SERVO MODE.**

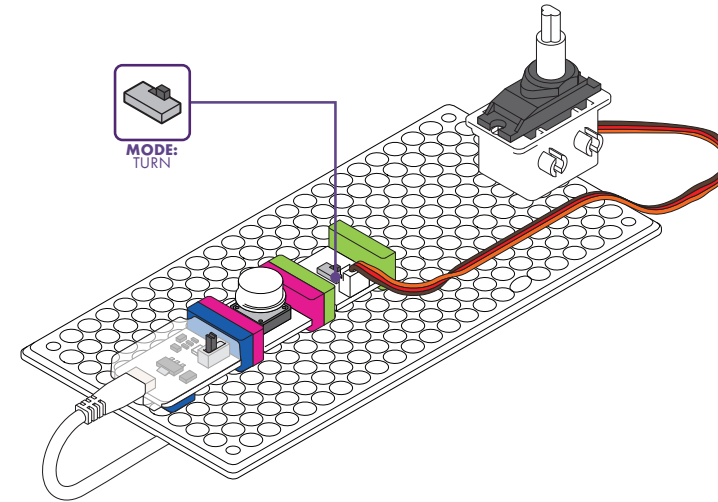

**SLIDE THE BATTERY INTO THE BATTERY MOUNT AND ATTACH IT TO THE BACK OF THE MOUNTING BOARD.**

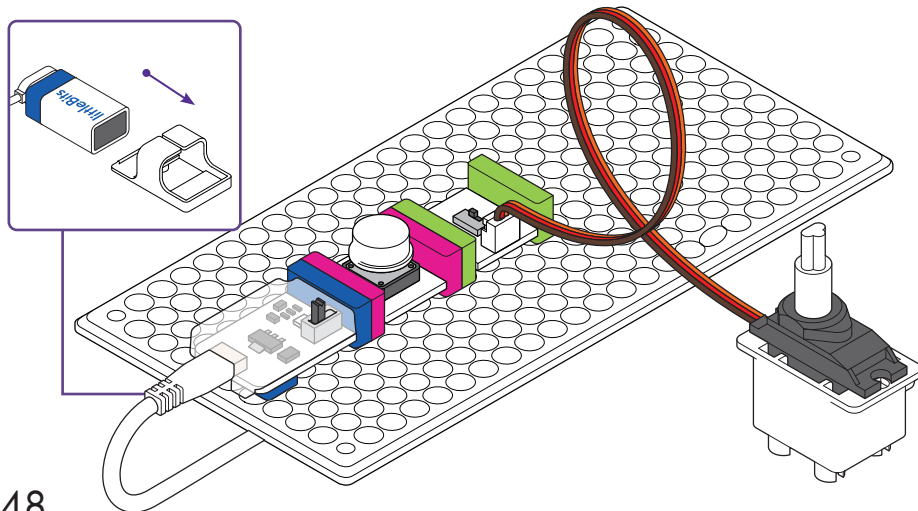

**TURN POWER ON.**

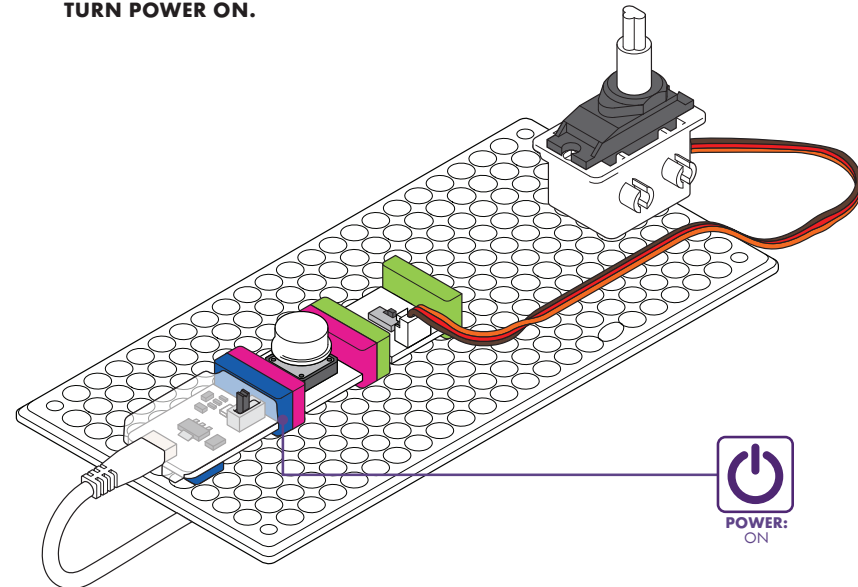





**WITH POWER ON, CONNECT THE MECHANICAL ARM TO THE SERVO AT A 90 DEGREE ANGLE TO THE MOUNTING BOARD, AS SHOWN.**

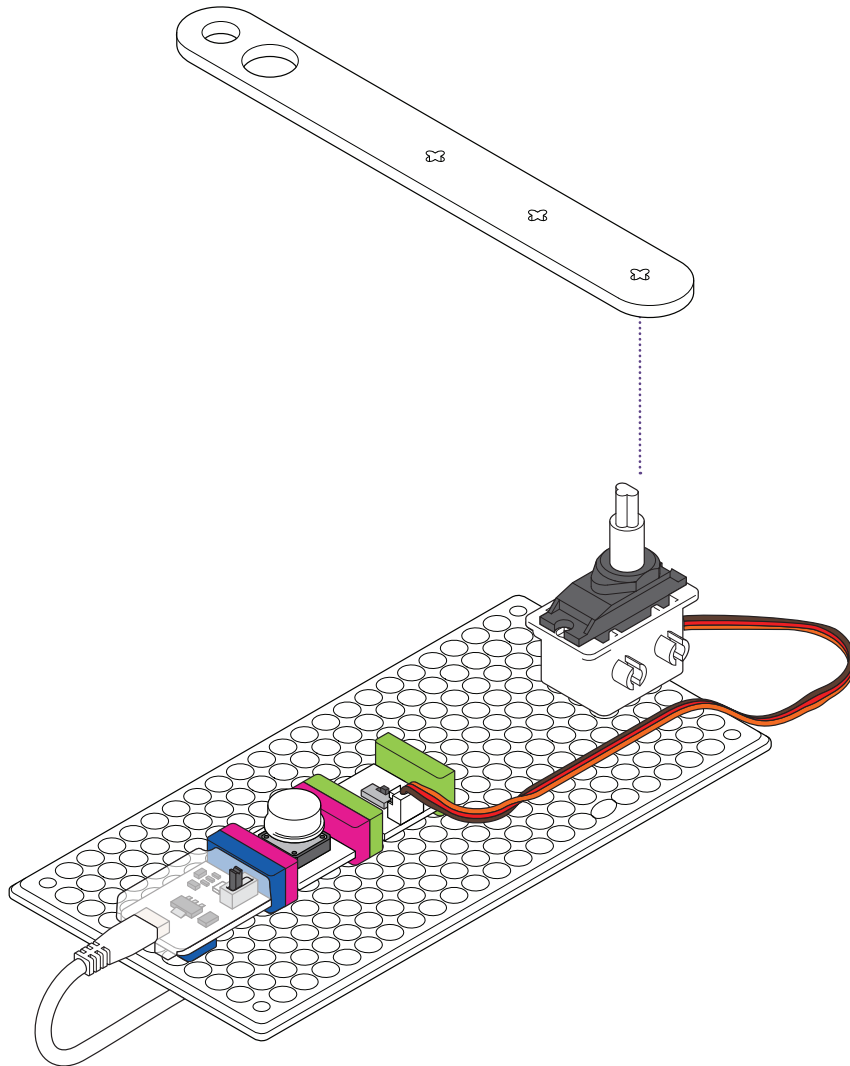

**MAKE A BUCKET FOR THE LAUNCHER.**

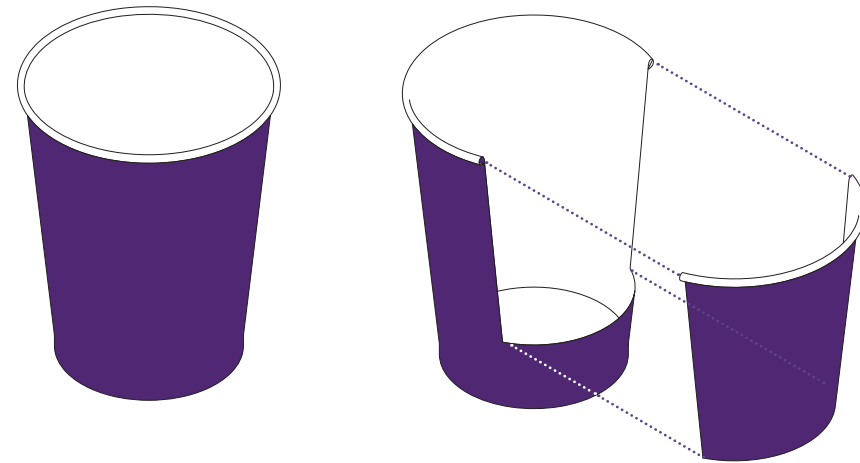

**TAPE THE BUCKET TO THE FREE END OF THE MECHANICAL ARM.**

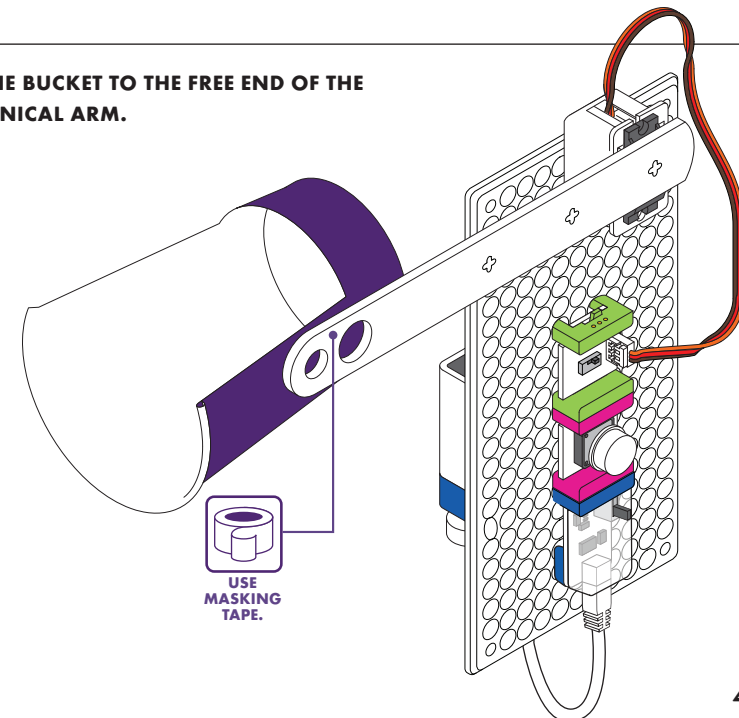





9

CRUMPLE UP A HALF SHEET OF NOTEBOOK PAPER TO LAUNCH.

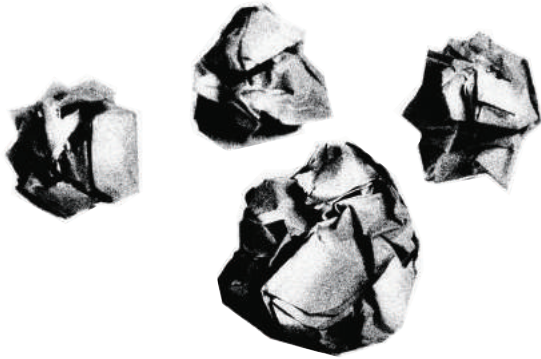

10

TEST YOUR CIRCUIT. Pressing the button should rotate the mechanical arm. Troubleshooting pg 71.



TEST YOUR CIRCUIT.

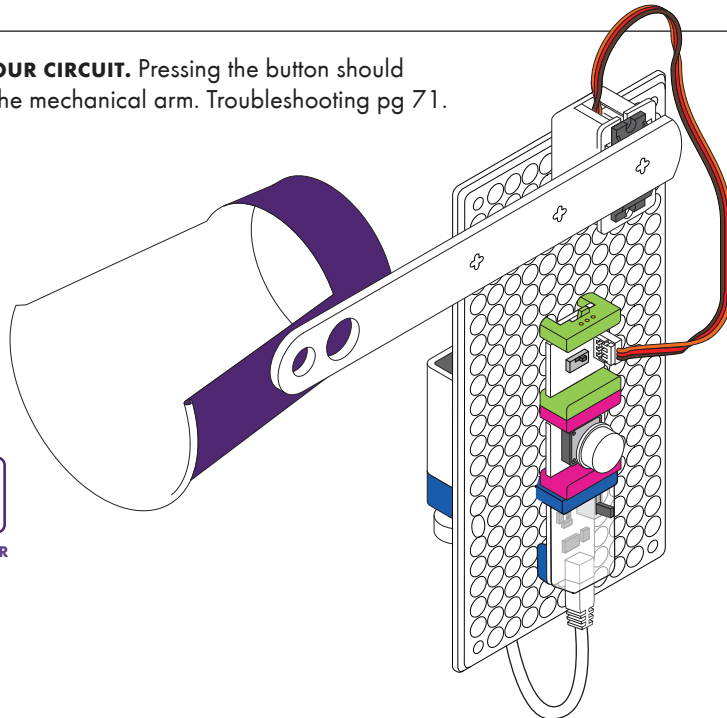

50

 **PLAY!**



Now it's game time!  
Create a target and invent  
a game with your friends.

# HOW IT WORKS

**p7 POWER** sends a signal to the button.

When pressed, the **i3 BUTTON** lets the signal through to the servo.

When the **o11 SERVO** gets the signal, it turns, rotating the arm and throwing the projectile.

## **a23 MECHANICAL ARM**

The farther you place your cup from the servo hub, the faster it will swing. You can experiment with extending the mechanical arm with other materials, but you'll have to pay attention to weight.

As the cup gets farther from the hub, it also takes more force to move it. If your arm gets too long it will overpower the servo motor and will be hard to move. This relationship between distance and force is called torque.

## **o11 SERVO**



When it's in **TURN** mode, the position of the servo is determined by the incoming signal. At 0 volts, the servo is all the way to the left. If the incoming signal is at full power (5 volts), the servo arm is all the way to the right. When the button makes the signal go from 0 to 5 volts quickly, the arm swings quickly. This speed helps your ball fly farther.



## REMIX

WHAT DO YOU WANT TO IMPROVE OR CHANGE? LET'S EXPERIMENT!

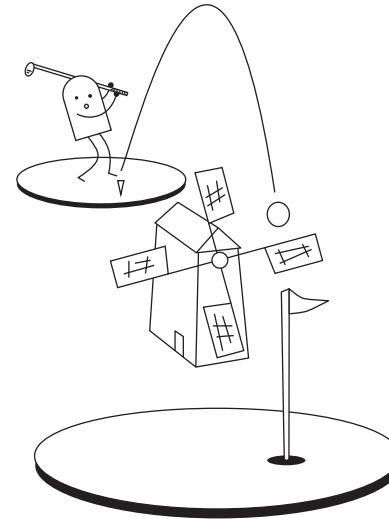
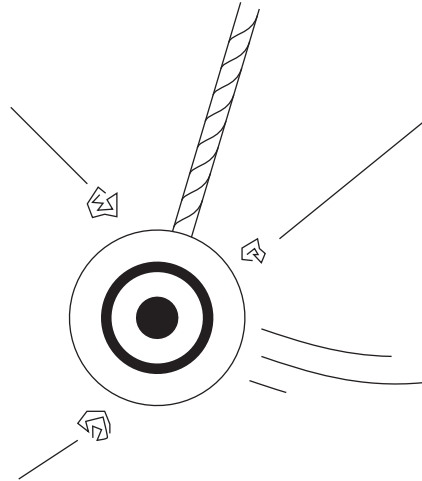
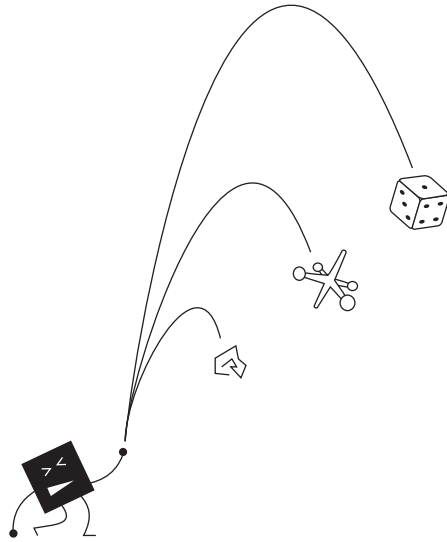

### A TRY EXPERIMENTING WITH THE MECHANICS OF YOUR CATAPULT.

- How does changing the length of the mechanical arm change the throwing distance?
- Try different objects for balls. What gets thrown the farthest? How does the size and shape affect the distance traveled?
- What happens when you change the bucket size or shape? How does it affect the throw?

### B HOW COULD USING OTHER BITS MAKE IT BETTER?

- Switch the button with a pulse Bit for automatic firing.
- Add a number Bit to count the number of shots taken.
- Creating a moving target with one of the motors and the other mechanical arm.

### C WHAT OTHER GAMES CAN YOU PLAY? COULD YOU INVENT YOUR OWN?

- Try miniature golf, baseball, or bowling!

## SHARE



**WHAT NEW GAME DID YOU INVENT?** Make it official. Give it a name. Write the official rules and share what you created.

**GATHER YOUR FRIENDS AND START A TOURNAMENT.** What do they think of the game? Is it too easy? Too hard? Just right?



SHARE YOUR INVENTIONS  
ONLINE AT LITTLEBITS  
CLASSROOM







#### CHALLENGE 04

# INVENT A SECURITY DEVICE



TIME

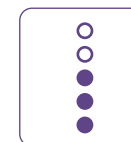

LEVEL

**START BY MAKING THE BACKPACK ALARM WITH THE LIGHT SENSOR, PULSE, AND BUZZER.** This light-sensitive alarm will alert you if someone is snooping around your stuff. Customize your alarm for different places around the school.

#### BITS™ + MATERIALS

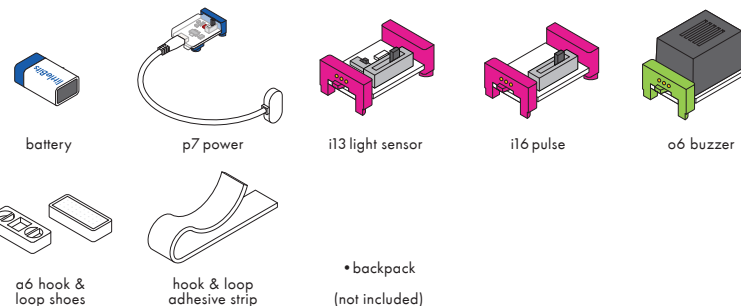



# CREATE

BUILD YOUR CIRCUIT.

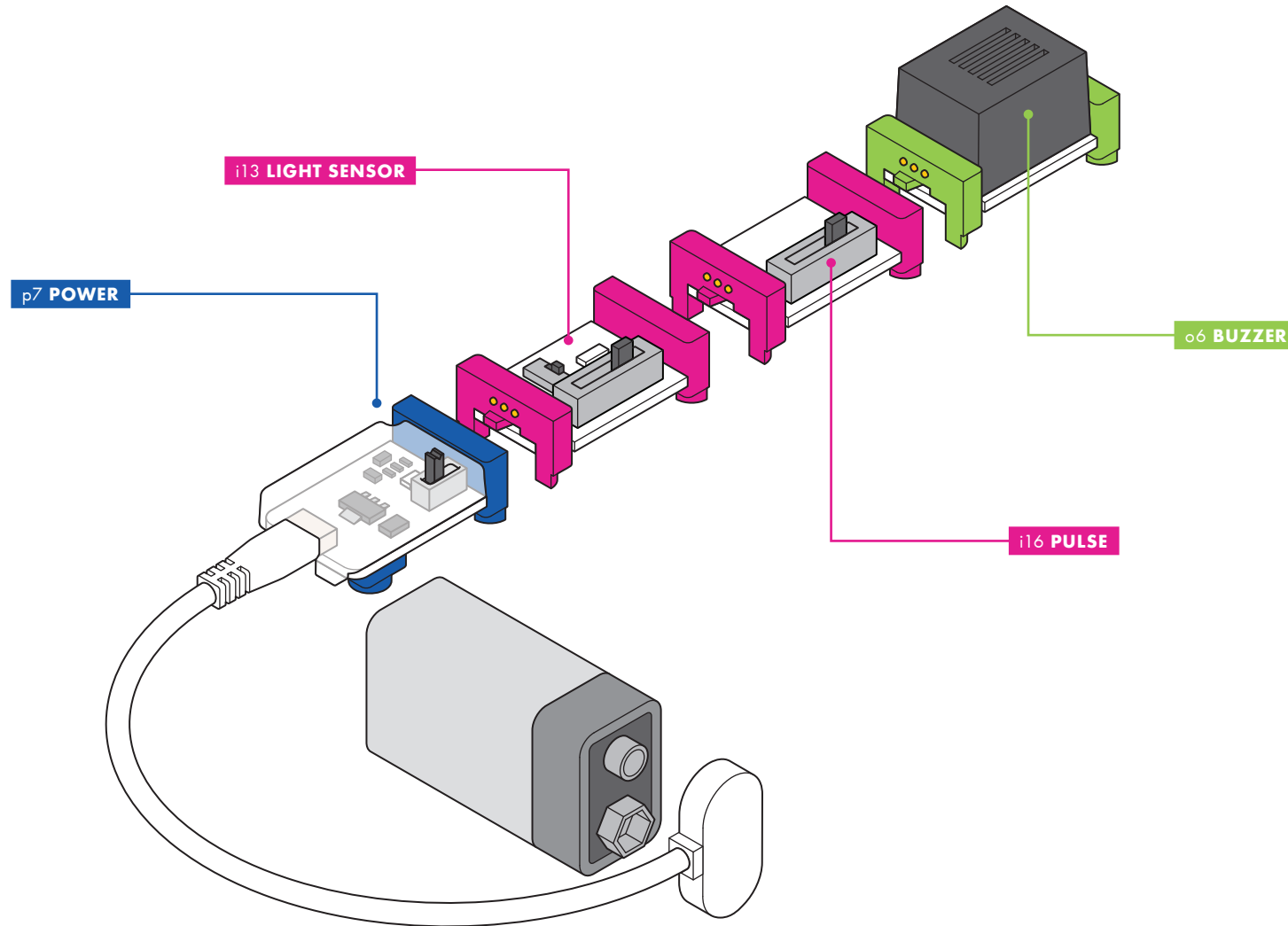





**ADJUST YOUR LIGHT SENSOR.** Switch to "light" mode and move the sensitivity slider all the way to the right.

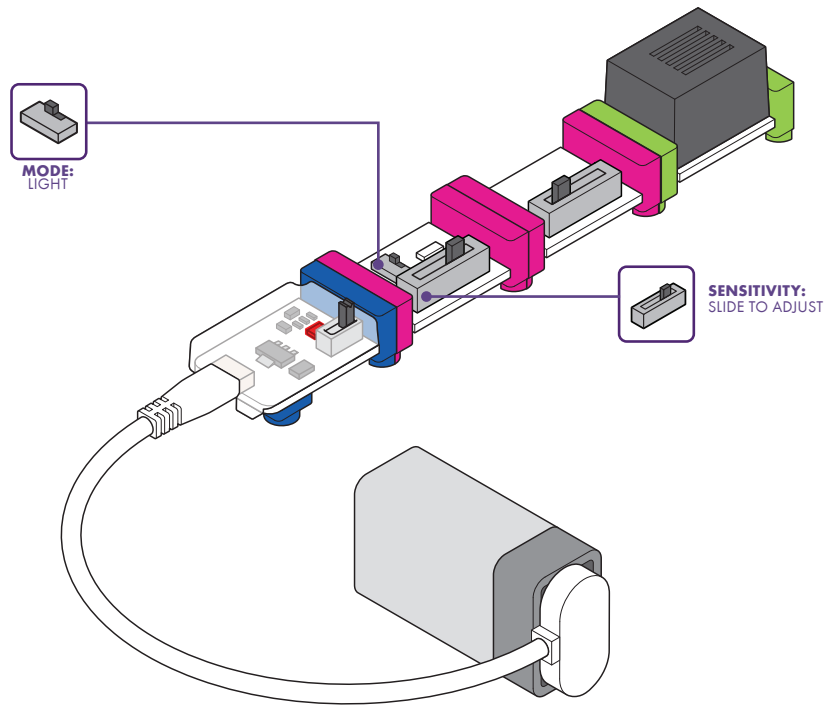

**SET THE PULSE SPEED TO THE SLOWEST SETTING.**

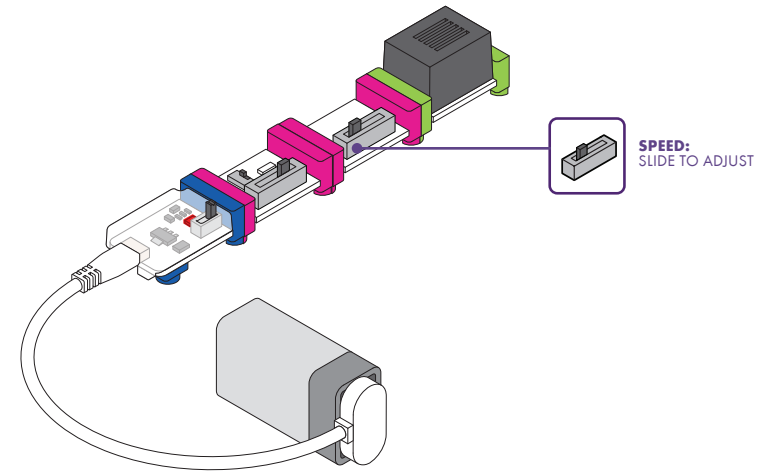

**PRESS HOOK & LOOP SHOES ONTO YOUR CIRCUIT.**

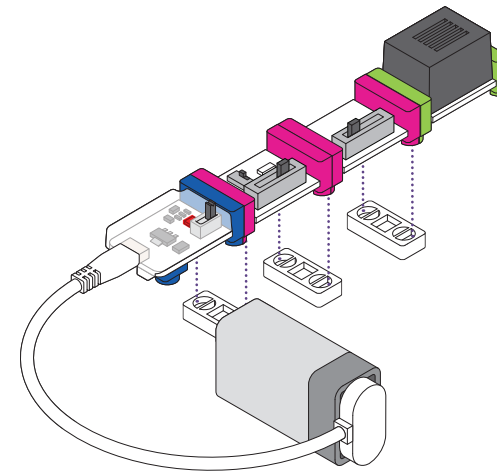



**PLACE THE ALARM INSIDE YOUR BACKPACK.**

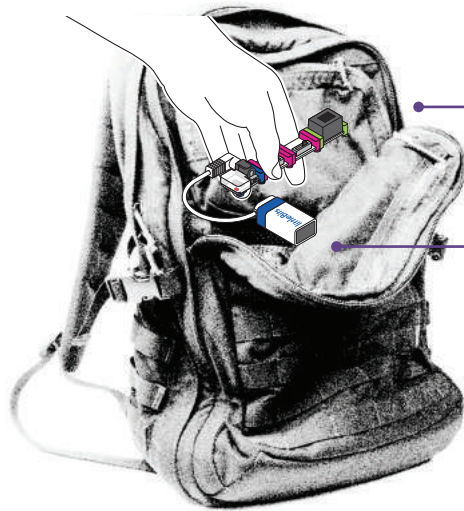

**PRO TIP:**  
TRY USING THE  
HOOK & LOOP  
STRIP TO KEEP YOUR  
CIRCUIT IN PLACE.

**TEST YOUR CIRCUIT.** The buzzer should BUZZ when your circuit is exposed to light, and stop buzzing when it is completely covered up. You may need to adjust the sensitivity of your light sensor to get it just right. Troubleshooting p. 71.

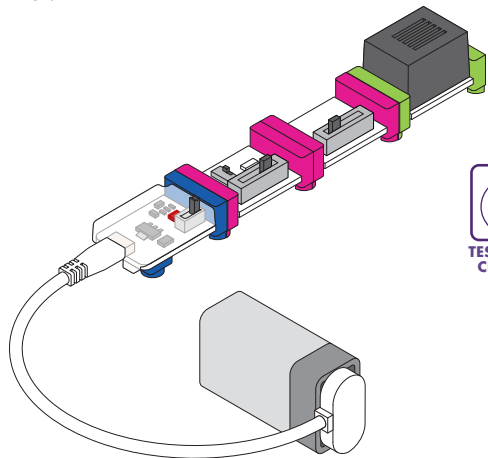

 **PLAY!**





Can anyone open your backpack without setting off the alarm?



# HOW IT WORKS

## i13 LIGHT SENSOR

-  Some bags might not be totally dark inside. If your alarm sounds even in the bag, try sliding the sensitivity slider to the left a little. If your alarm doesn't sound at all, make sure the sensitivity slider is moved all the way to the right.
-  This is the light sensor component. It only senses light that reaches it, so the direction that the circuit faces will affect how much light is sensed.

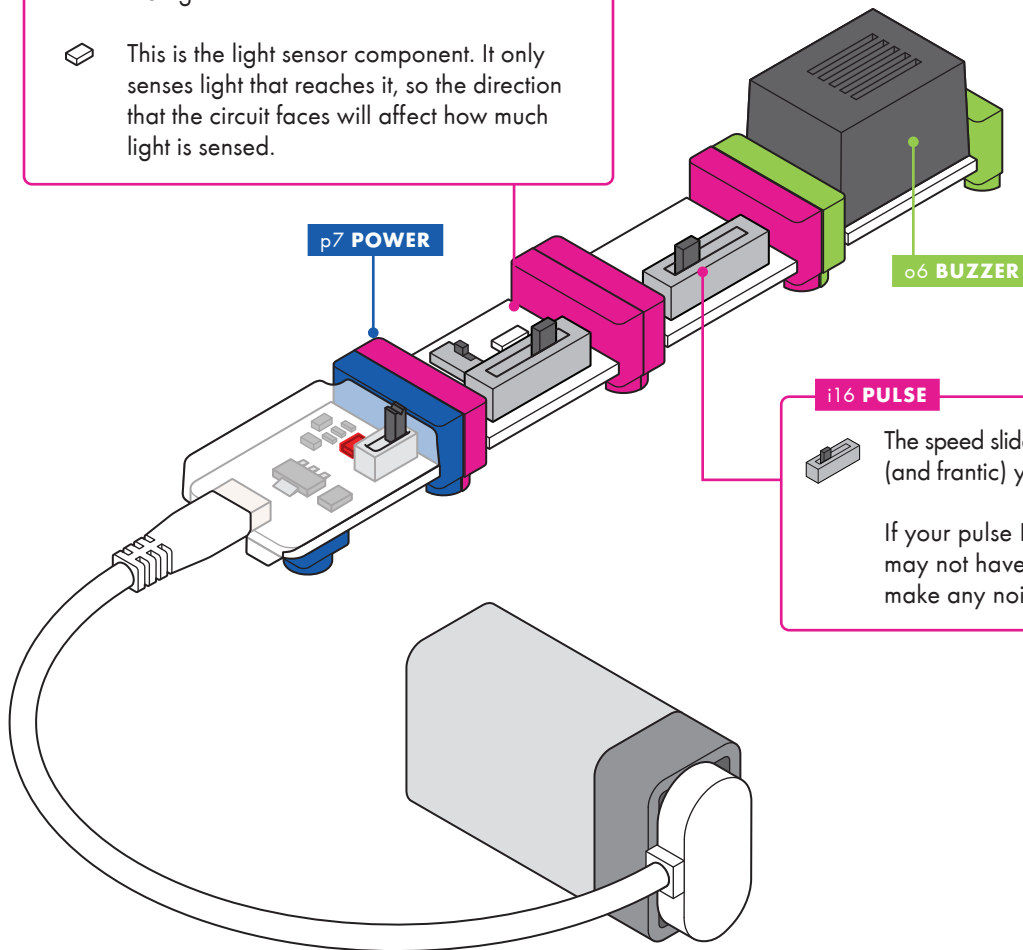

## i16 PULSE

-  The speed slider will let you adjust how fast (and frantic) your alarm sounds.
- If your pulse Bit is set too fast your buzzer may not have time to vibrate and may not make any noise.

The **p7 POWER** sends a signal through the circuit.

The **i13 LIGHT SENSOR** is in light mode. When the alarm is inside your bag, no light hits the sensor, so it doesn't allow a signal to pass through. When you open the bag, light shines in on the sensor, letting the signal through to the pulse. The more light that shines on the sensor, the more signal it lets through and the louder your buzzer will sound.

The **i16 PULSE** Bit is continuously switching on and off. When it gets a signal from the light sensor, it only lets it through in short bursts.

The **o6 BUZZER** sounds when it gets the signal from the pulse, but is quiet when the pulse flips off. This changing between on and off produces the alarm noise to scare off the snooper.



## REMIX

HOW CAN YOU CUSTOMIZE YOUR ALARM?

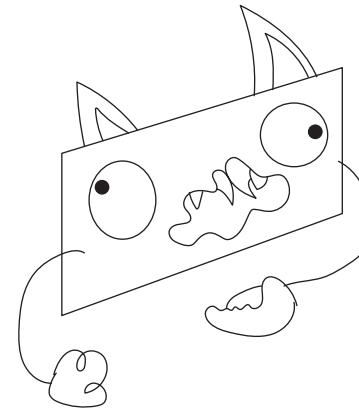
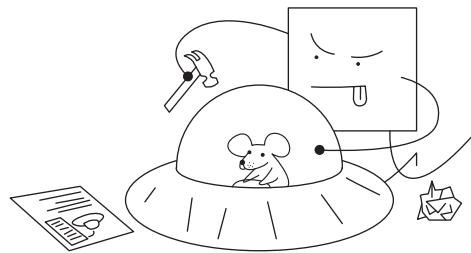

### A CHANGE THE BIT SETTINGS.

- Switch the light sensor mode to **DARK** to create an alarm that sounds when it is dark. Where could an alarm like this be useful?
- If your alarm didn't sound reliably, try adjusting the sensitivity of the light sensor.
- Adjust the speed of the pulse Bit to change how fast the alarm sounds. What setting do you think makes the best alarm?

### B WILL YOUR ALARM WORK IN DIFFERENT PLACES OR SCENARIOS?

- Try it in your desk drawer, locker, or under your backpack.
- Put it on the windowsill as a wake-up alarm.
- Use it to prank someone when they turn out the lights.

### C MAKE YOUR ALARM MORE EFFECTIVE.

- Snap on a DC motor and create a sign with a scary monster on it.
- Amplify the sound (try using a paper cup or cone).
- Add lights.

## SHARE



**PROMOTE YOUR INVENTION!** Create a 30-second commercial explaining how useful it is.

**HOW DO YOUR CLASSMATES' ALARMS COMPARE WITH THE ORIGINAL DESIGN?** Write a product review for your favorite tech publication.



SHARE YOUR INVENTIONS  
ONLINE AT LITTLEBITS  
CLASSROOM





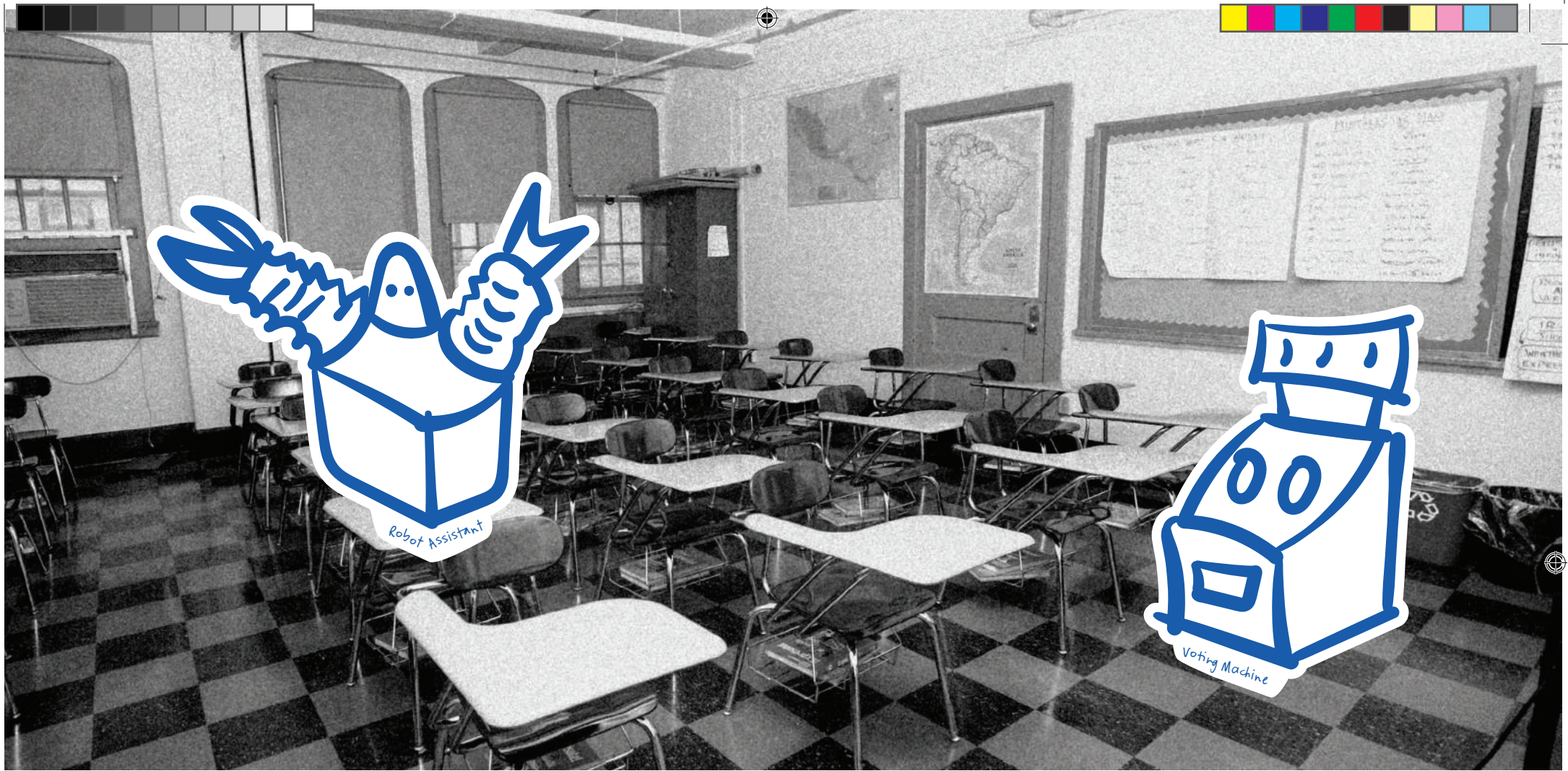

OPEN CHALLENGE 01

# HACK YOUR CLASSROOM

**1**  
HOUR  
(MINIMUM)

TIME

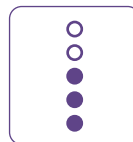

LEVEL

**USE BITS AND YOUR WITS TO MAKE THE CLASSROOM OF THE FUTURE.** You spend a lot of time in your school and classroom. How can you make it even more fun to be there? Pinpoint something that could be easier, especially exciting, or that you wish existed. Use your expertise to design an invention that makes school extra awesome. Perhaps your new invention will become an essential part of the classroom in the future!





# CREATE

**CREATE A LIST OF WAYS YOU COULD MAKE YOUR CLASSROOM BETTER.** Need ideas? Ask your friends or teachers about what bothers them or what they'd like improved. You could even level-up something you already like.

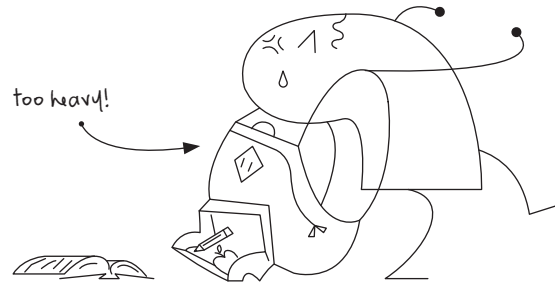

**SELECT THE ISSUE YOU WANT TO WORK ON.** Maybe it's something a lot of people feel strongly about, or that you find particularly interesting.

	fun	useful	
A	X	O	
B	O	X	
C	X	X	✓

**LOOK THROUGH YOUR BITS AND MATERIALS AND THINK ABOUT HOW EACH ONE COULD HELP.** Could motion, light, or sound help you achieve your mission? How about buttons or dimmers? If you're not sure what a Bit does or how it could help, snap it into a circuit and start to play with it. If you're still stumped, read through the "Bit Index" section at the beginning of this booklet.

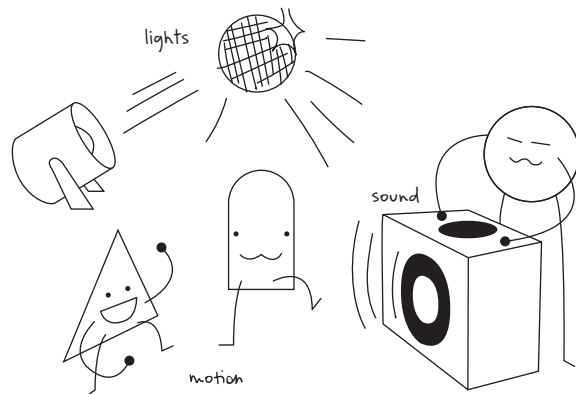

**SKETCH OUT IDEAS, PICK YOUR FAVORITE, AND CREATE A PROTOTYPE.** When you create a physical model of your idea, it is easier to understand how it works. Don't worry about getting everything right on the first try though. The important thing is to just get started and experiment.

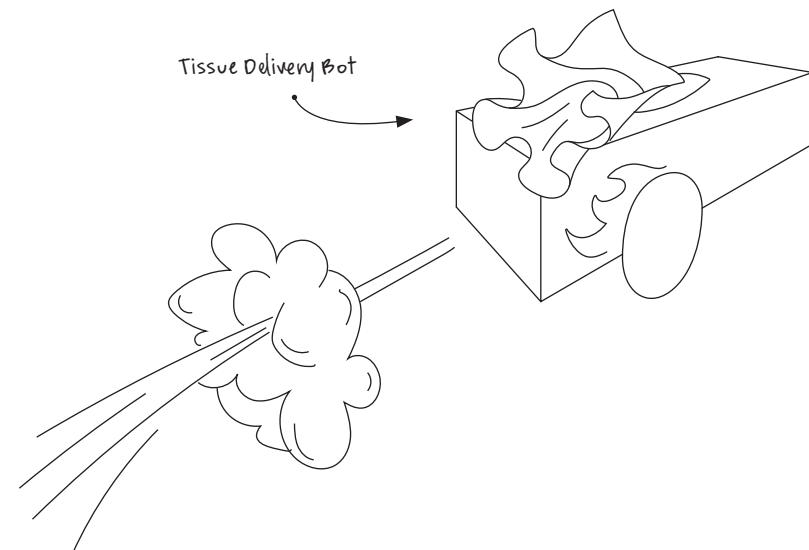

## PLAY!

## REMIX

## SHARE



**PRO TIP:** EVERY TIME YOU TRY SOMETHING NEW, PLAY WITH YOUR INVENTION TO TEST IT OUT.

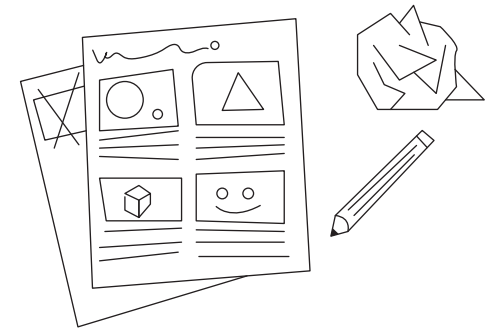
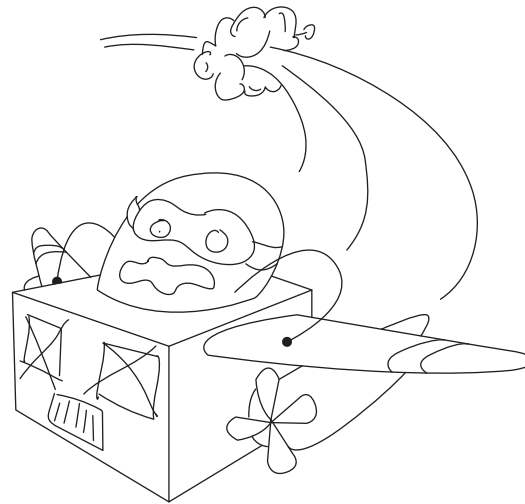
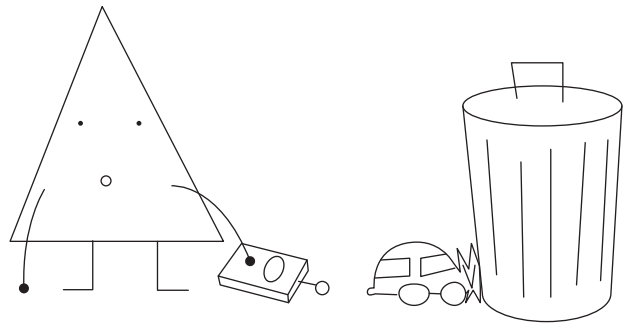

SHARE YOUR INVENTIONS ONLINE AT [LITTLEBITS CLASSROOM](https://www.littlebitsclassroom.com)

**TEST YOUR PROTOTYPE.** Set up your invention in the classroom and see what you can learn about how it works. Your invention might not work the way you thought, but that's ok, it's part of the invention process! Take note of what works and what doesn't so you can improve it.

**DID PLAYING WITH YOUR INVENTION GO THE WAY YOU EXPECTED?** Now's your chance to experiment with fixes and improvements. You might need to make things sturdier, work on the mechanics of moving parts, or try using different Bits to achieve your mission.

**MAKE WACKY AND WEIRD EXPERIMENTS PART OF YOUR INVENTION PROCESS.** Sometimes really great ideas come from unexpected places. Close your eyes and pick a Bit at random. How could this Bit add something cool to your invention? Is it better now or before? Try this with a few different Bits.

**CREATE A SHORT COMIC.** Show what classroom life was like before and after your invention, and how it has improved things. Inventors often draw comics like these called storyboards to describe how their invention works. These stories are a great way to show people what you did and why it's important.

**SET UP AND SHOW OFF YOUR INVENTION TO SOME CLASSMATES OR YOUR TEACHER.** How can their feedback help your invention grow? Do they have ideas for improvements? Can they think of other ways it could be used? Their ideas can be great fuel for another round of remixing, playing, and sharing.



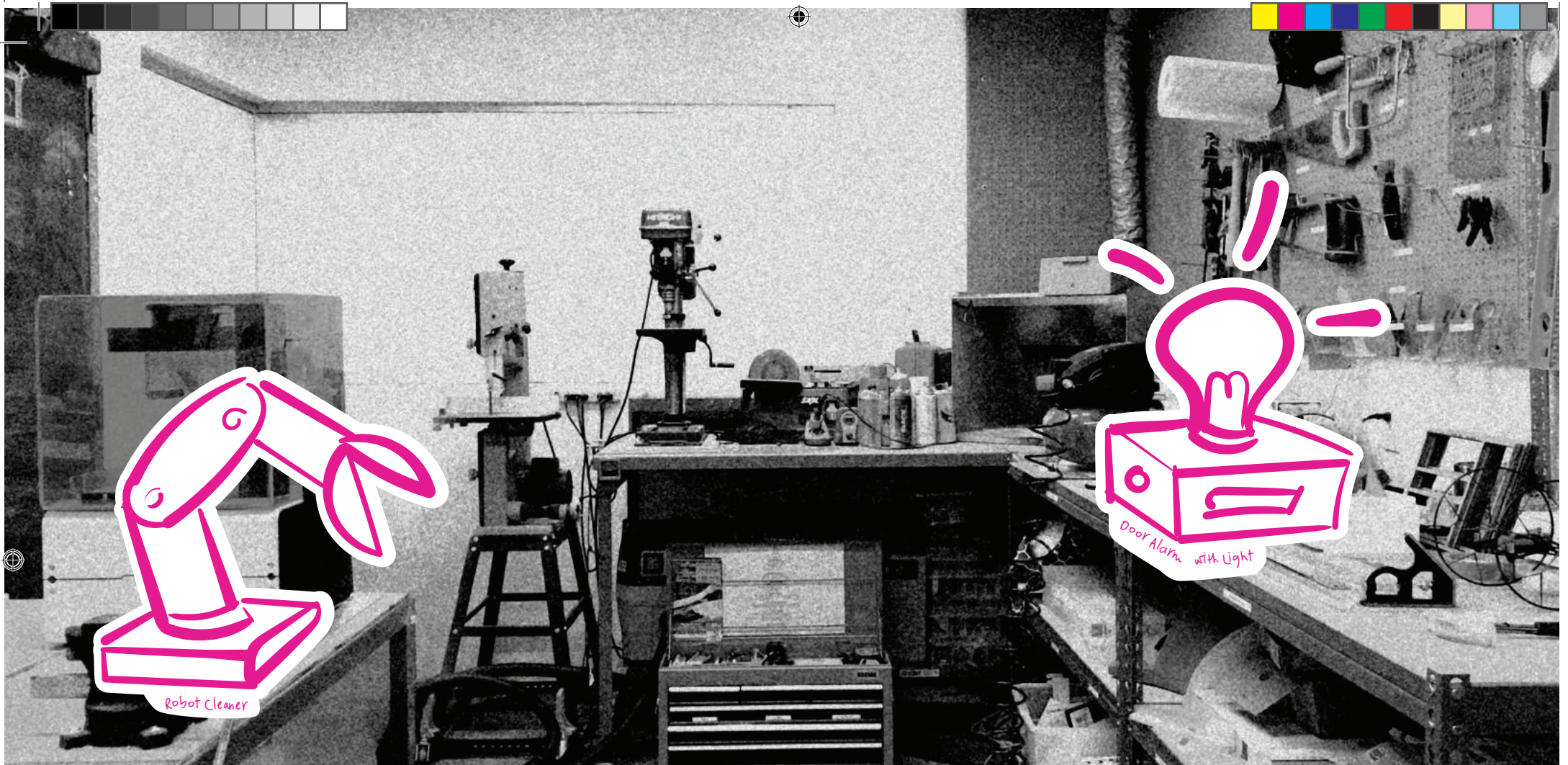

OPEN CHALLENGE 02

# INVENT FOR GOOD

**2**  
HOURS  
(MINIMUM)  
TIME

○  
●  
●  
●  
●  
LEVEL

**INVENT A PRODUCT TO MAKE A DIFFERENCE IN SOMEONE ELSE'S LIFE.** How does a product get invented? Here at littleBits™ we use the Invention Cycle! When it's time to create a new kit we go through the same process that you do. We brainstorm, create prototypes, play with them, let kids around the country play with them, and we remix over and over again until we get things right. When it's all done, we get to share it with the world. In this challenge you're going to think like a product designer and invent something that helps someone else. Who knows, maybe you'll start the next company like littleBits!



## CREATE

**CREATE A LIST OF IDEAS FOR A PRODUCT.** Start by thinking about where there are frustrations or difficulties in someone's life. For example, a person who has trouble hearing might need a way to know if someone is knocking at their door.



**SELECT THE ISSUE YOU WANT TO WORK ON.** It could be the one that sounds the most fun to solve, or creates the biggest difference in someone else's life.

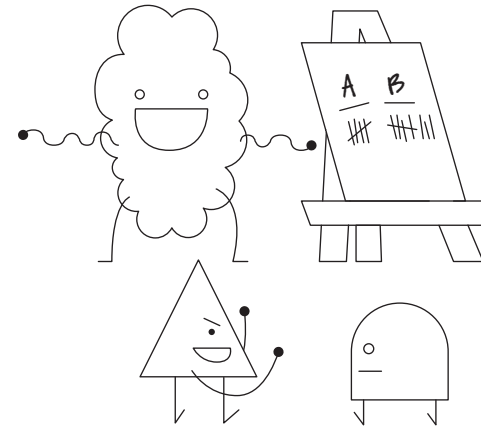

**LOOK THROUGH YOUR BITS™ AND MATERIALS AND THINK ABOUT HOW EACH ONE COULD HELP.** Also take a look at everyday objects you could make better with Bits. For example, if you wanted to design a product that makes doing chores more fun, you could start with a broom.

**SKETCH OUT IDEAS, PICK YOUR FAVORITE, AND CREATE A PROTOTYPE.** Don't worry about getting everything right on the first try. The important thing is to just get started and experiment. Building a physical model of your idea makes it easier to share with others and collect feedback on your design.

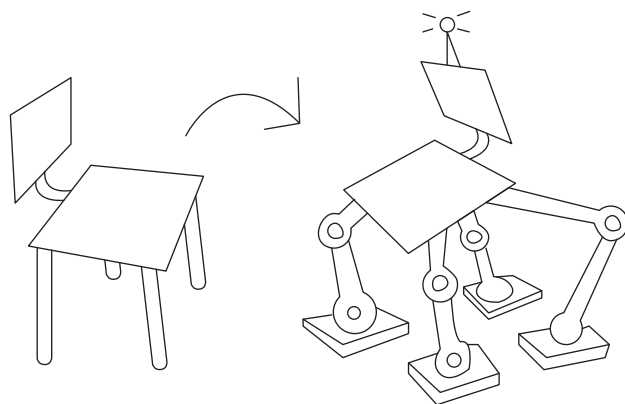



## PLAY!

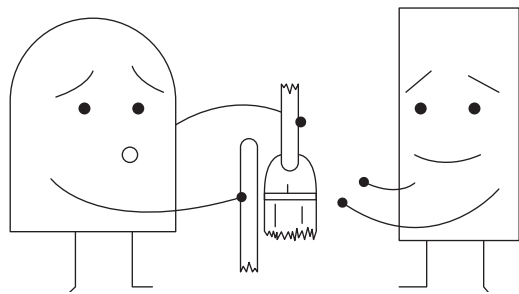

## REMIX

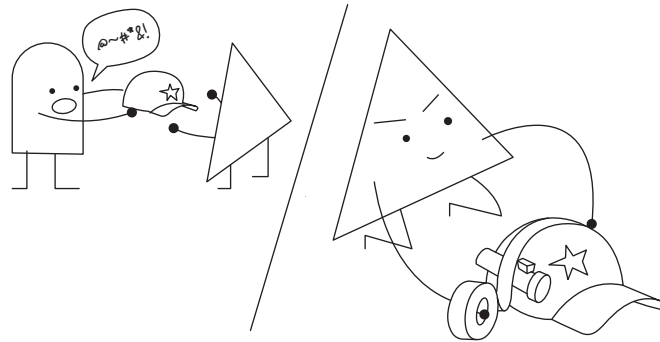

## SHARE

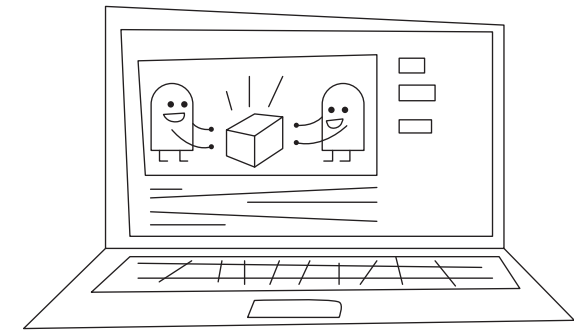

SHARE YOUR INVENTIONS  
ONLINE AT LITTLEBITS  
CLASSROOM

**TEST YOUR PROTOTYPE.** The first product tester will be you. Pretend you are a customer who just purchased your invention. How well does it do its job? Take notes about what works and what doesn't. You can make changes in the next version.

**DID PLAYING WITH YOUR INVENTION GO THE WAY YOU EXPECTED?** Now's your chance to experiment with fixes and improvements. Could adding a new Bit™ add important features? Would craft materials make it stronger or give it a new look?

**HAVE SOMEONE ELSE TEST YOUR INVENTION AFTER YOU'VE MADE A FEW IMPROVEMENTS.** If possible, try to find the type of person you're designing it for. Ask about their favorite parts, and what suggestions they have for making it better. Use their feedback to create an even better version of your invention.

**CREATE A SKIT, A PRINT, OR VIDEO ADVERTISEMENT ABOUT WHAT YOU'VE INVENTED.** It should explain what your invention is and how it can help make life better for the customer. Share it with the world!

**RECRUIT A TEAM.** A lot of product designers work in teams because sharing different ideas and perspectives makes for a better design process. Show your invention to some friends. Could you all work together to create an even better product?



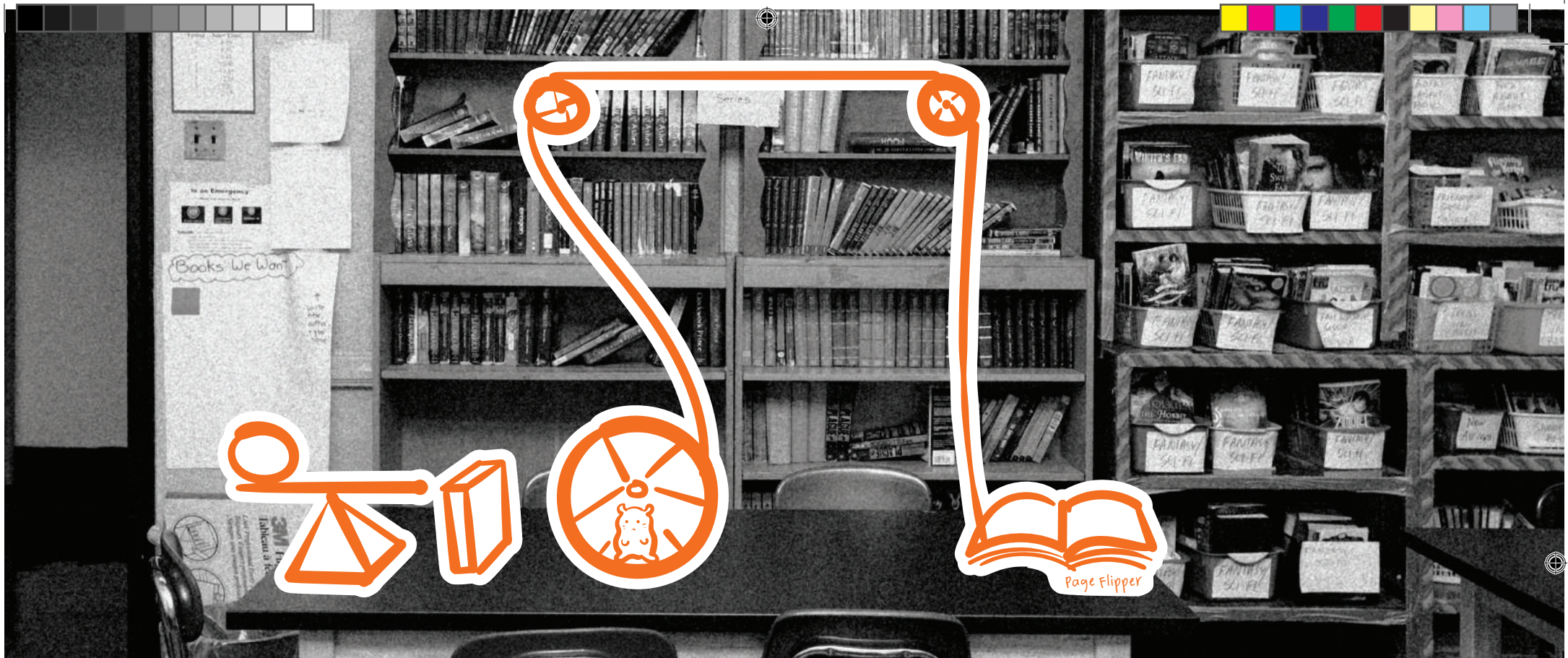

OPEN CHALLENGE 03

# INVENT A CHAIN REACTION CONTRAPTION

**3**  
HOURS  
(MINIMUM)

TIME

●  
●  
●  
●

LEVEL

**PERFORM A VERY SIMPLE TASK IN A NOT-SO-SIMPLE WAY.** Rube Goldberg was a cartoonist who liked to draw really complicated solutions to very simple problems. For example, to turn the page of a book, you might roll a ball down a ramp that hits a box. Then the box falls over and scares a hamster that starts running on its wheel, that winds up a string that turns the page. In this challenge, you're going to design your own multi-step machine. Before you start inventing, there are two important rules:

- 1) Once you start your machine, it needs to be able to run without any help from you. Each step must be triggered automatically by the step before it.
- 2) Your machine should have at least two steps. (Bonus points if you can create more steps!)



# CREATE

**CREATE A LIST OF EVERYDAY ACTIVITIES THAT ONLY TAKE ONE STEP.** For example, dropping a can in the recycling bin, flipping on a light switch, or opening a book.

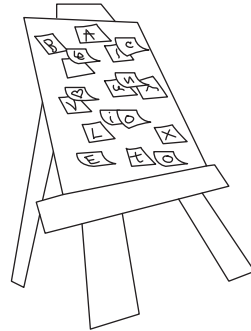

**SELECT THE EVERYDAY ACTIVITY YOU WANT TO ACCOMPLISH.** Which one do you think will be the most fun for this challenge?

- 1 \_\_\_\_\_
- 2 \_\_\_\_\_
- 3 \_\_\_\_\_
- 4 \_\_\_\_\_
- 5 \_\_\_\_\_
- 6 \_\_\_\_\_
- 7 \_\_\_\_\_
- 8 \_\_\_\_\_
- 9 \_\_\_\_\_
- 10 \_\_\_\_\_

**LOOK THROUGH YOUR BITS AND MATERIALS AND THINK ABOUT HOW EACH ONE COULD HELP.** Could motion, light, or sound help you achieve your mission? How about buttons or dimmers? If you're not sure what a Bit™ does or how it could help, snap it into a circuit and start to play with it. If you're still stumped, read through the "Bit Index" section at the beginning of this booklet.

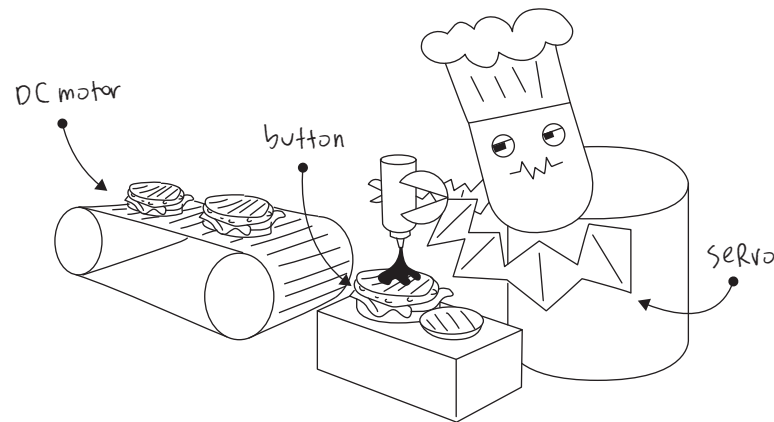

**SKETCH OUT IDEAS, PICK YOUR FAVORITE, AND CREATE A PROTOTYPE OF YOUR CONTRAPTION.** Don't worry about getting everything right on the first try. The important thing is to just get started and experiment.

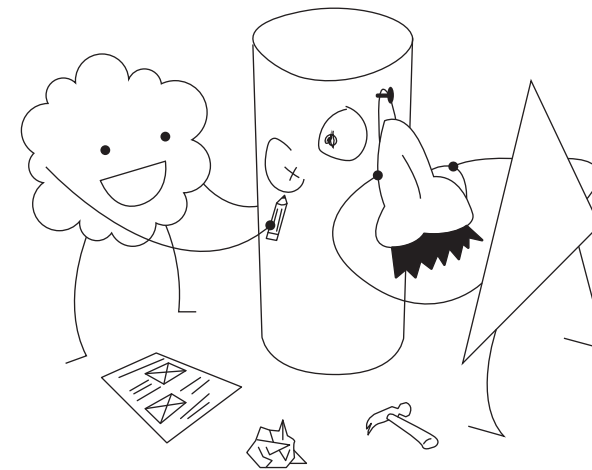

## PLAY!

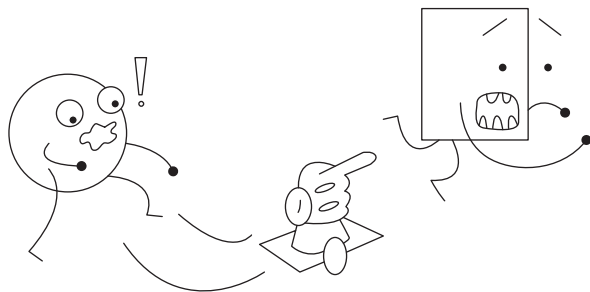

**TEST YOUR PROTOTYPE.** Getting all of these moving pieces to work together is going to be a challenge. Try running your contraption a few times. Record where it works the best and where it isn't so reliable. You can use this information to refine your design.

## REMIX

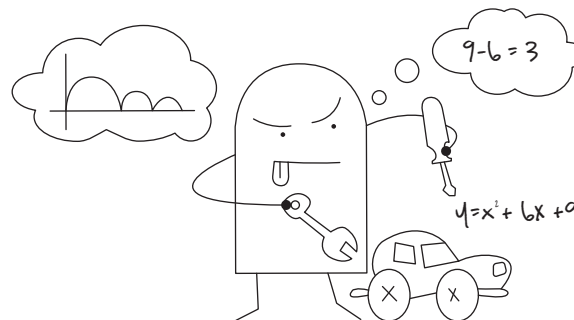

**DID PLAYING WITH YOUR INVENTION GO THE WAY YOU EXPECTED?** Now's your chance to experiment with fixes and improvements. How can you make your machine more reliable? Maybe you need to strengthen some materials, change the angle of a ramp, or try using different Bits™ for one of your steps.

Set your invention aside and look through your remaining Bits and materials. Could you complete a step with them? Try a few options to see how they compare to what you already have.

## SHARE

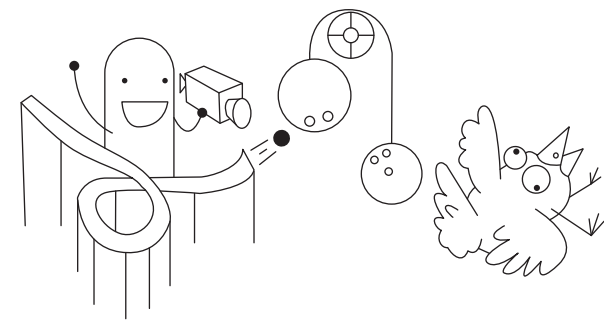

SHARE YOUR INVENTIONS  
ONLINE AT LITTLEBITS  
CLASSROOM

**TAKE A VIDEO OF YOUR INVENTION AND POST IT TO YOUR FAVORITE SOCIAL MEDIA CHANNEL.** People love watching a crazy contraption in action! While you're online, look up some Rube Goldberg cartoons and create your own that describes what your invention is used for and how it works.

Challenge a friend. Show them your invention and see if they can accomplish the same task, but using totally different steps.



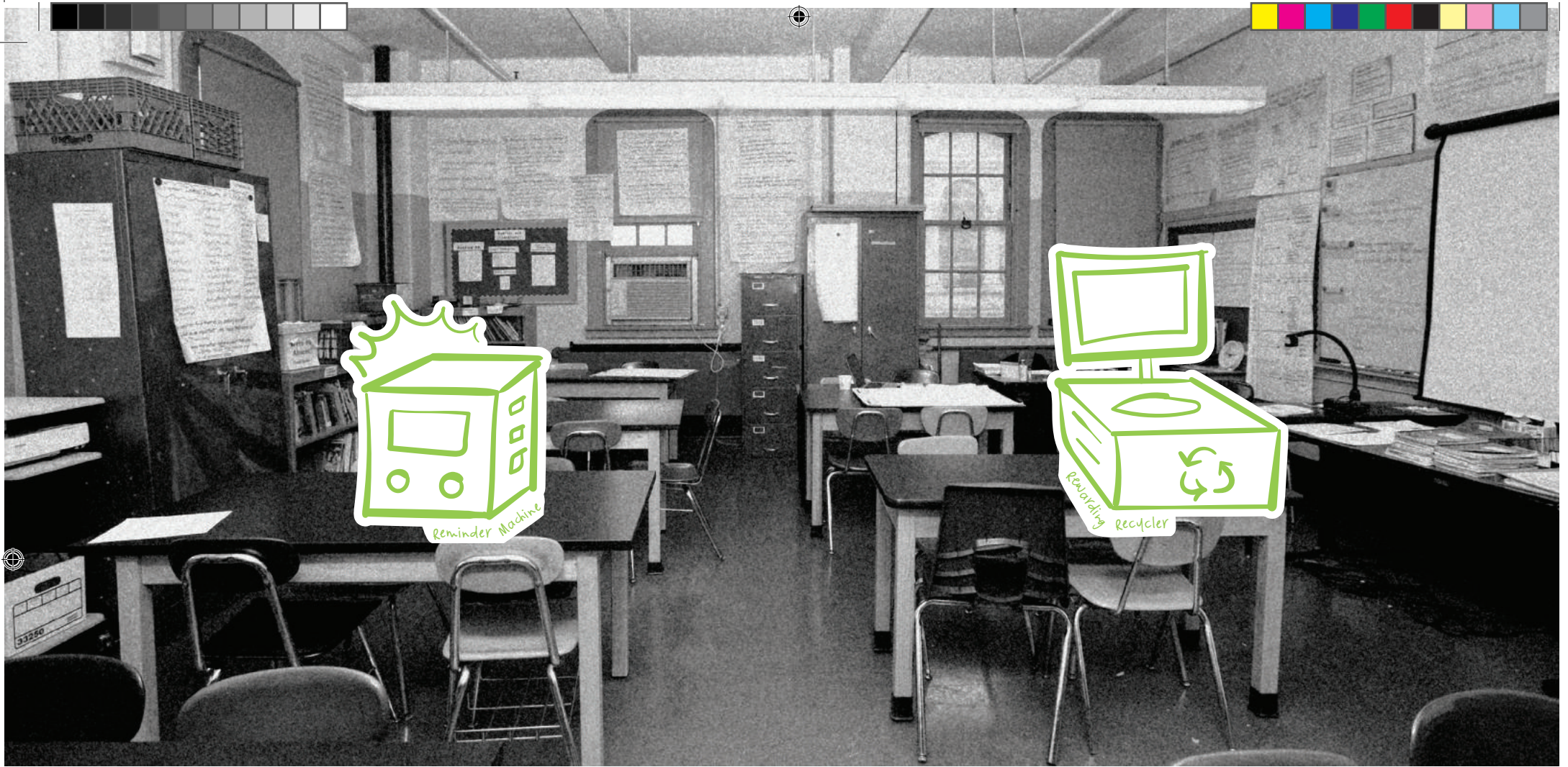

OPEN CHALLENGE 04

# HACK YOUR HABITS

**4**  
HOURS  
(MINIMUM)

TIME

●  
●  
●  
●

LEVEL

**CREATE AN INVENTION TO TRACK YOUR DAILY HABITS, THEN TRANSFORM YOUR INVENTION TO MAKE LIFE BETTER.** How much use does your classroom's recycling bin get? Maybe you could invent something to encourage people to use it more often! How many times a day do you have to go back to your locker because you forgot something? Maybe you could invent something that counts these trips and reminds you to grab what you need! Now's your chance to use your inventing powers to get to the bottom of these types of questions and invent a gadget to make your everyday experience better.



# CREATE

**CREATE A LIST OF THINGS YOU OR YOUR CLASSMATES DO THAT YOU WANT TO KNOW MORE ABOUT.** Maybe it's a habit you'd like to improve on (how can I make fewer trips to my locker?), something you're curious about (how many high fives can I get in a day?), or an issue you'd like to help other people understand (why don't your classmates recycle?). Try to list as many different habits as possible.

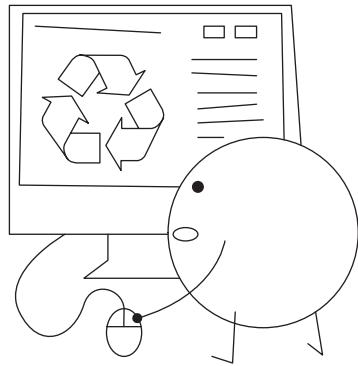

**SELECT THE HABIT YOU WANT TO LEARN MORE ABOUT.** Is there one that makes you the most happy, passionate, or upset? It's always good to work on something that means a lot to you.

option A

Pros	Cons
_____	_____
_____	_____
_____	_____
_____	_____
_____	_____
_____	_____

**LOOK THROUGH YOUR BITS™ AND MATERIALS AND THINK ABOUT HOW EACH ONE COULD MEASURE OR TRACK THAT HABIT.** Could the button help you know when something is moved? Could the light sensor detect when something is opened?

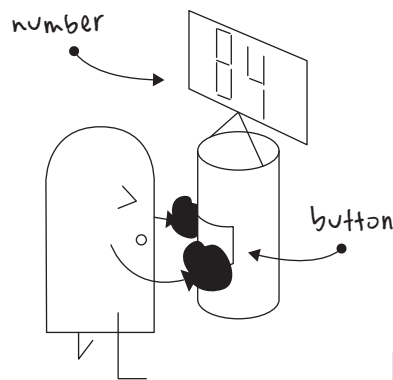

**PRO TIP:** PAIRING AN INPUT BIT™ WITH THE NUMBER (IN COUNT MODE) CAN BE A REALLY HELPFUL COUNTER IN THIS PROJECT.

**SKETCH OUT IDEAS, PICK YOUR FAVORITE, AND CREATE A PROTOTYPE OF A DATA-COLLECTION MACHINE.** Don't worry about getting everything right on the first try. The important thing is to just get started and experiment. Building a physical model of your idea will help you figure out the best way to track habits.

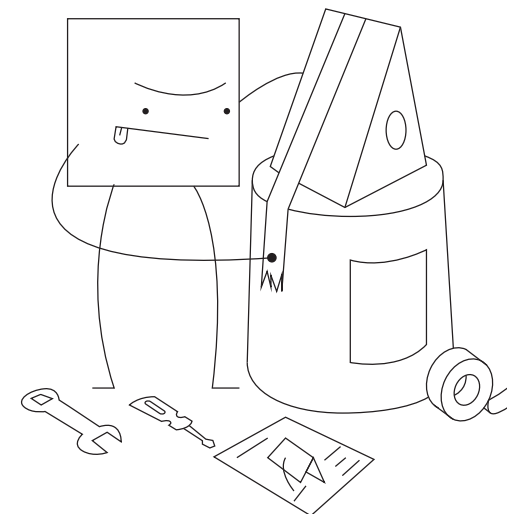



## PLAY!

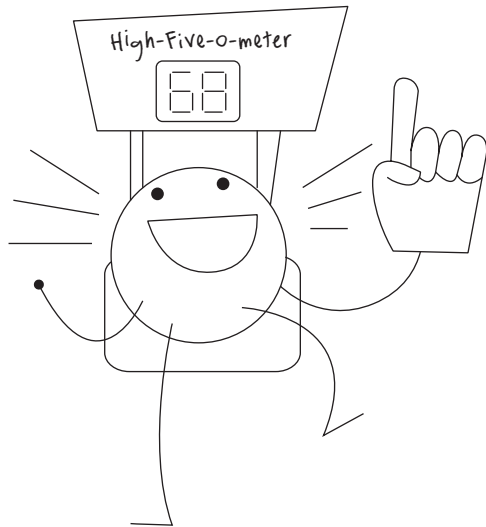

**TEST YOUR PROTOTYPE.** To get it working reliably, it will probably take a bit of adjusting and redesigning. Once you have it down, you can start tracking your life.

**MAKE A HYPOTHESIS ABOUT THE RESULTS YOU WILL GET.** For your first trial, decide how long you want to use the invention for. For example, if you're tracking recycling bin use, how many times do you think it gets used daily? Soon you'll have data to test your theory!

## REMIX

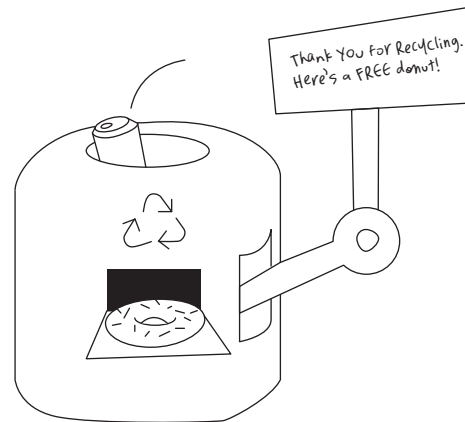

**DID PLAYING WITH YOUR INVENTION GO THE WAY YOU EXPECTED?** Now's your chance to experiment with fixes and improvements. Did it gather data well? Do you think it was accurate? Now that you know a little more about your circuit and the habit you're exploring, you can tinker with the invention to make it work better.

**HOW CAN YOU ADD NEW FEATURES TO CHANGE PEOPLE'S HABITS?** For example, could an invention that tracks use of the recycling bin also reward people for recycling? Would that make them more likely to recycle? Try it out and see if it changes your data.

## SHARE

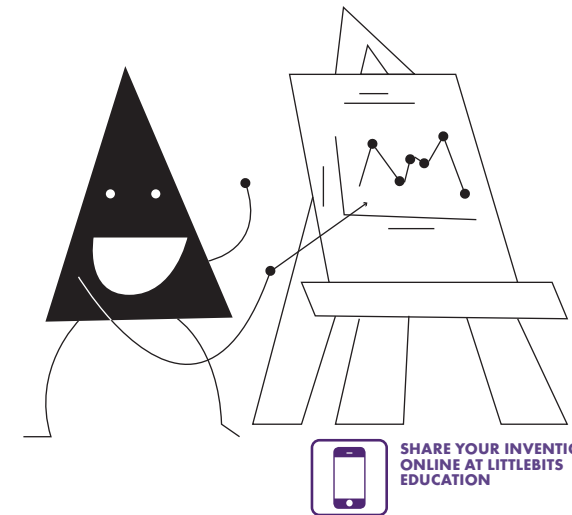

**COMPARE THE TRACKING INFORMATION FROM BEFORE AND AFTER YOU MADE CHANGES.** Now you know more about how people behave and what motivates them. More importantly, you have the data to prove it! Create a poster that describes the habit you were studying and how your invention affected it. Share it with the world!

**HAVE SOMEONE ELSE TRY YOUR INVENTION FOR THE DAY.** Do you think your invention could be useful elsewhere? Maybe another classroom wants to encourage recycling, or a friend wants to know what seats in the cafeteria are the most popular.

# TROUBLESHOOTING

 IN-DEPTH TROUBLESHOOTING  
AVAILABLE AT [SUPPORT.SPHERO.COM](https://support.sphero.com)  
OR ON THE LITTLEBITS INVENT APP.

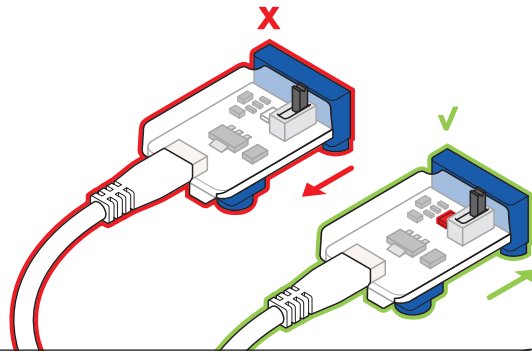

1

**MAKE SURE YOUR POWER BIT™ IS ON.** You should see a red LED illuminated on the board.

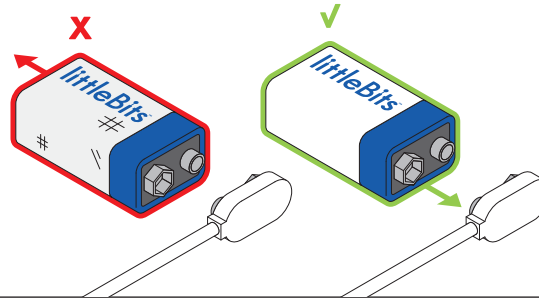

2

**TRY SWAPPING IN A NEW 9 VOLT BATTERY.** Low batteries can cause a circuit to act erratically. Bits™ have different power demands. For example: a DC motor may appear to not be working while a light still shines brightly.

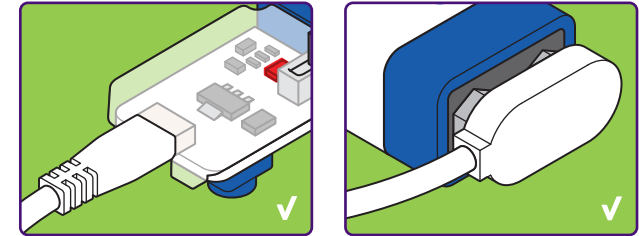

3

**ENSURE THE POWER CABLE IS SECURELY FASTENED TO BOTH THE POWER BIT AND THE BATTERY.**

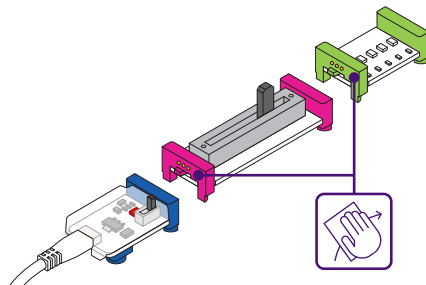

4

**CHECK YOUR CONNECTIONS.** Are all the Bits securely snapped to each other? You can also try gently wiping down the ends of the bitSnaps with a soft cloth (like your sleeve). Sometimes dust gets in the way of a strong connection. Try unsnapping, cleaning the bitSnaps, and snapping it all back

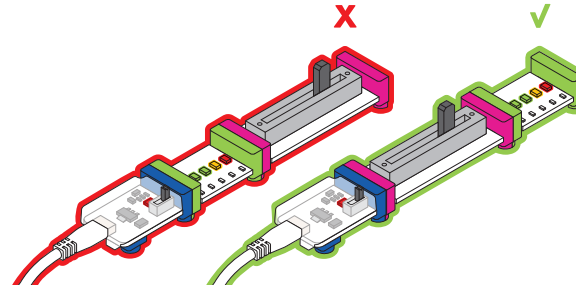

5

**MAKE SURE YOUR BITS ARE ARRANGED IN THE PROPER ORDER.** Remember that you always need a power Bit & power supply at the beginning of each circuit, and an output Bit at the end. If the last Bit in your chain is an input, then it won't do anything to affect your circuit.

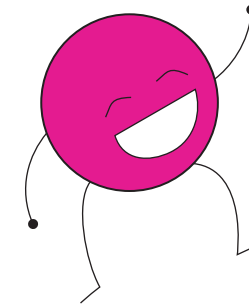

**STILL HAVING TROUBLE?** Visit [littleBits.com/faq](https://littleBits.com/faq) or contact our customer service team at [support@littleBits.com](mailto:support@littleBits.com).



# CONTINUE YOUR INVENTOR JOURNEY

The inventing doesn't stop here! Discover new friends, new challenges, and new invention adventures online at littleBits™ Classroom.

## EXPLORE LITTLEBITS CLASSROOM FOR...

### **MORE INVENTIONS!**

See what other Inventors have made with littleBits.

### **MORE BITS!**

Add Bits and Kits to your collection for bigger and better inventions!

### **MORE CHALLENGES!**

Take on new challenges and submit your solutions.







p3  
**USB  
POWER**

i5  
**SLIDE DIMMER**

i12  
**TEMP-  
ERATURE  
SENSOR**

i3  
**BUTTON**

i16  
**PULSE**

i13  
**LIGHT  
SENSOR**

p7  
**POWER**

o21  
**NUMBER**

o11  
**SERVO**

w1  
**WIRE**

o6  
**BUZZER**

o2  
**LONG  
LED**

w10  
**INVERTER**

o19  
**RGB LED**

w7  
**FORK**

o13  
**FAN**

o25  
**DC  
MOTOR**

**EXTRA STORAGE**

**MOTOR CROSS AXLE  
BITSHOES**

sphero  
**littleBits**  
**STEAM STUDENT SET**

**ACCESSORIES**

USB Plug Adapter  
1.5m USB Cable  
9V Battery and Clip  
Arm Cross Axle  
Plastic Wheel  
Twist Ties  
Small Mounting Board  
Battery Cable  
Hook and Loop Strip