



littleBits

CODE KIT

BIT INDEX

TABLE OF CONTENTS

- 1 INTRODUCTION
- 2 HOW TO USE LITTLEBITS

- BIT INDEX**
- 4 POWER
- 5 INPUT
- 10 WIRE
- 14 OUTPUT
- 21 ACCESSORIES

- 26 BITS NOT IN THIS KIT
- 34 INVENTION CYCLE
- 36 TROUBLESHOOTING

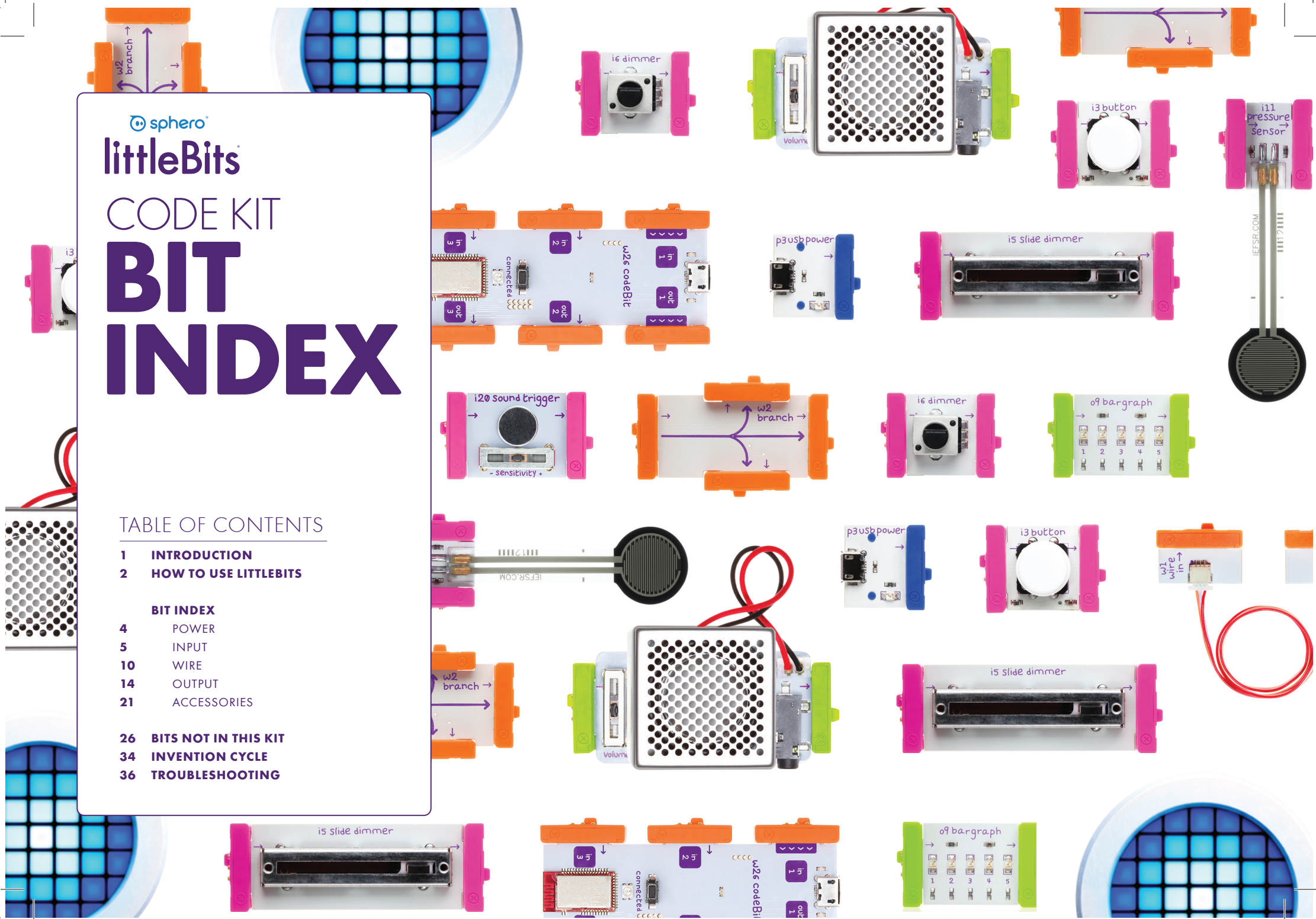

* Occasionally Bits™ and accessories get updated, so the features or appearance of your Bits may differ from those used in this guide.

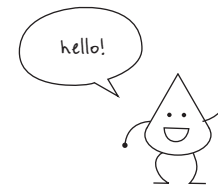

Hi. This is the Bit Index, the place where you can find everything you want to know about the Bits in your kit.

Find resources at:
classroom.littleBits.com

HOW TO USE LITTLEBITS

MAKE THIS CIRCUIT FIRST
And play with it!

What happens when you move this slider?

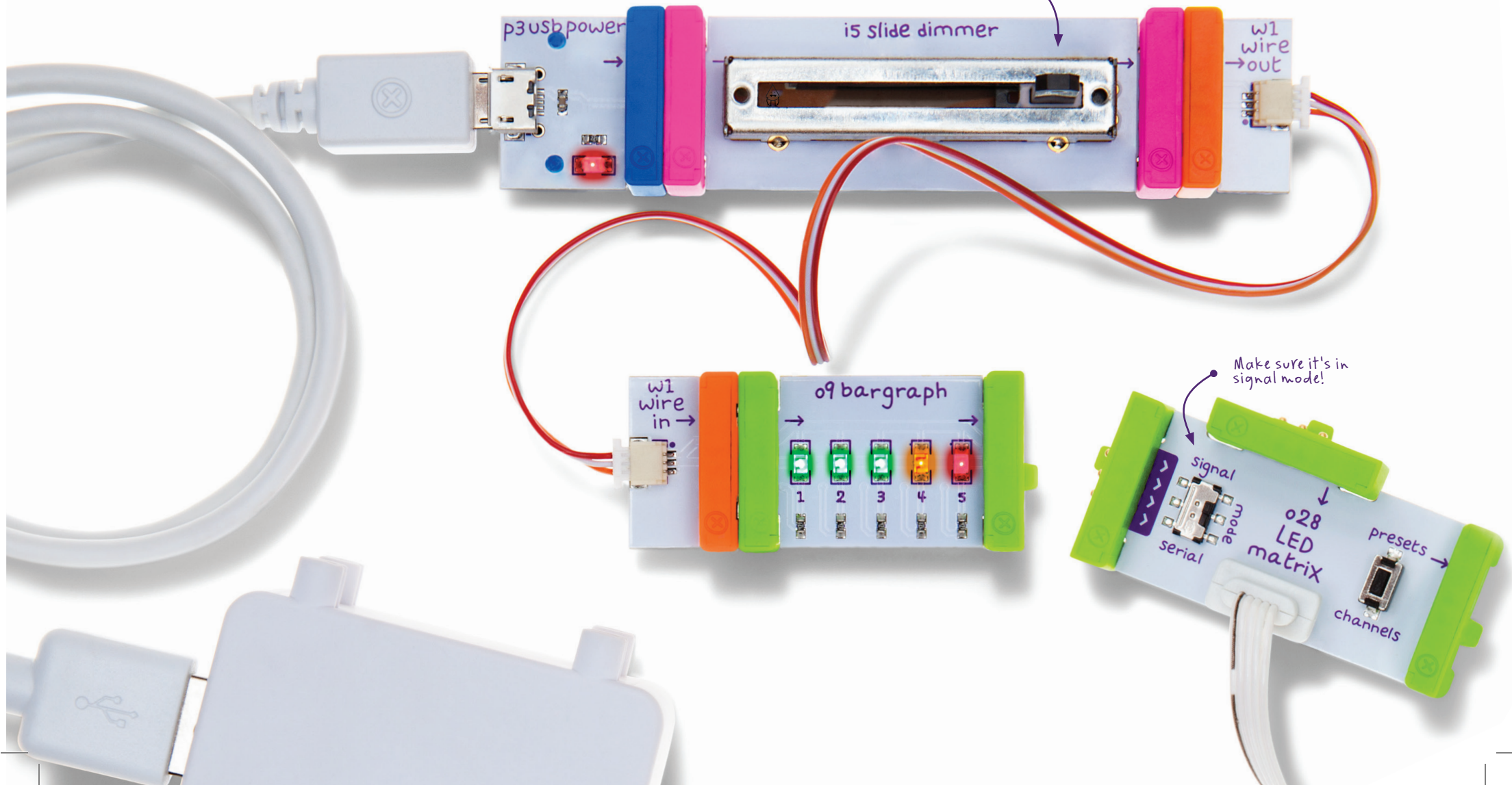

2 ANATOMY OF A BIT™

Learn how you can tell top from bottom.

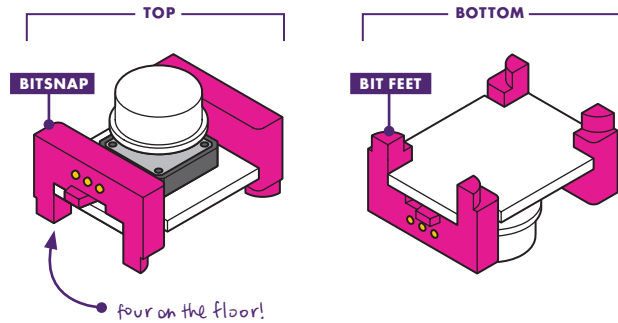

3 COLOR-CODED BY FUNCTION

Bits™ are grouped into four different categories, which are color-coded.

A POWER (BLUE)

Power Bits, plus a power supply, run power through your circuit.

C WIRE (ORANGE)

Wire Bits connect to other systems and let you build circuits in new directions.

B INPUT (PINK)

Input Bits accept input from you or the environment and send signals that affect the Bits that follow.

D OUTPUT (GREEN)

Output Bits do something – light up, buzz, move...

Learn more about your Bits **ON PAGE 04**

4 MAGNET MAGIC!

Bits snap together with magnets. The magnets are always right – you can't snap them together the wrong way.

ARROWS SHOULD POINT IN THE SAME DIRECTION

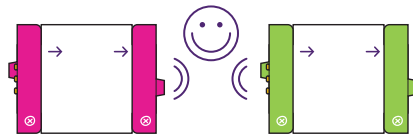

IF THE BITS WON'T SNAP TOGETHER, TRY SPINNING ONE AROUND AND MAKE SURE THE ARROWS POINT IN THE SAME DIRECTION



5 ORDER IS IMPORTANT

POWER BITS always come first and **INPUT BITS** only affect the **OUTPUT BITS** that come after them.

WITH NO OUTPUT BIT AFTER IT, THE INPUT BIT HAS NOWHERE TO SEND ITS SIGNAL



THE INPUT BIT AFFECTS THE OUTPUT BITS THAT FOLLOW

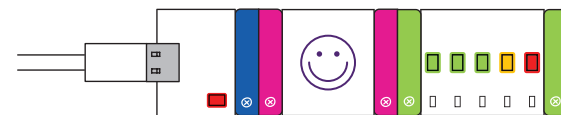

p3 USB POWER

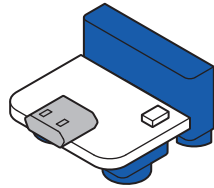

MEET THE BIT

The USB power may be the smallest in the series, but it's big enough to send electricity to all your creations. This Bit lets you power your circuit through a micro USB cable. It can be connected to a computer, the AC power adapter, or the rechargeable battery.

SAMPLE CIRCUIT

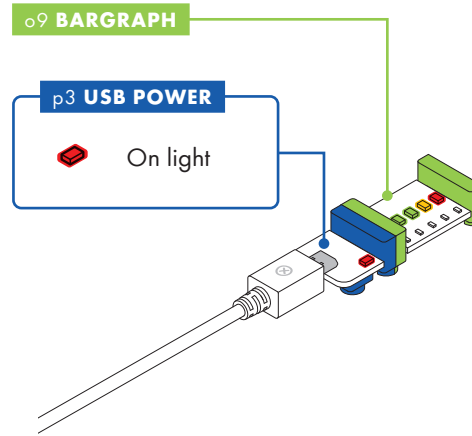

HOW IT WORKS

The USB power Bit sends a 5 volt signal through your circuit, which allows you to power up your Bits.

REAL WORLD ANALOGIES



PHONE CHARGER



LAPTOP CHARGER

i3 BUTTON

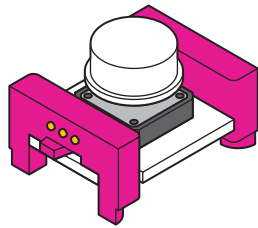

MEET THE BIT

The button Bit is a classic: big, round, and springy for comfortable pressing! Push it to turn something on and release it to turn it off.

MINI-CHALLENGE

Can you invent a chair that makes noise when you sit down?

SAMPLE CIRCUIT

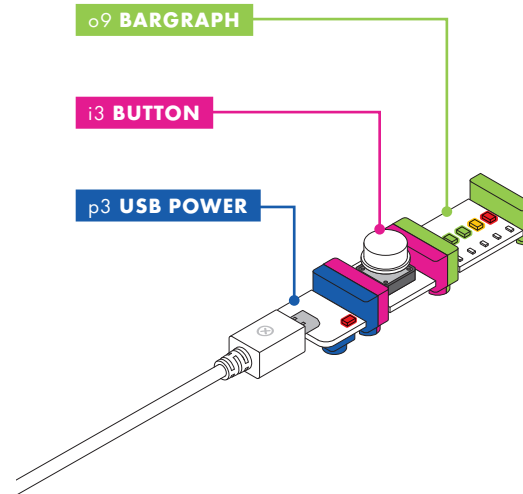

HOW IT WORKS

The button is like a door. When you press it, the door opens, letting the signal pass through the Bit and on to the next Bits in the circuit. The button is a momentary switch, you must continue to press it for the signal to flow. When you release the button, the door closes, stopping the signal from passing on to other Bits.

REAL WORLD ANALOGIES



VIDEO GAME CONTROLLER

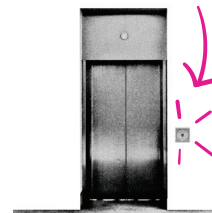

ELEVATOR BUTTON



GAME SHOW BUZZER

i5 SLIDE DIMMER

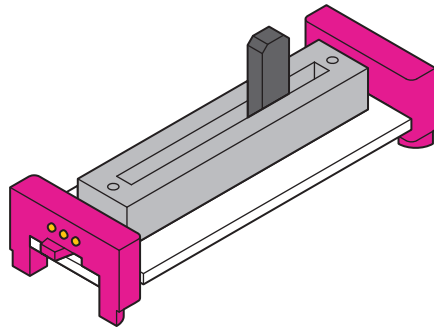

MEET THE BIT

Slide this dimmer back and forth to control your circuit. As you slide it up, more signal goes to the Bits that follow, brightening lights, speeding up motors, and raising the volume on buzzers.

MINI-CHALLENGE

Can you invent something with the slide dimmer that waves a flag back and forth? How could you change the speed it waves?

SAMPLE CIRCUIT

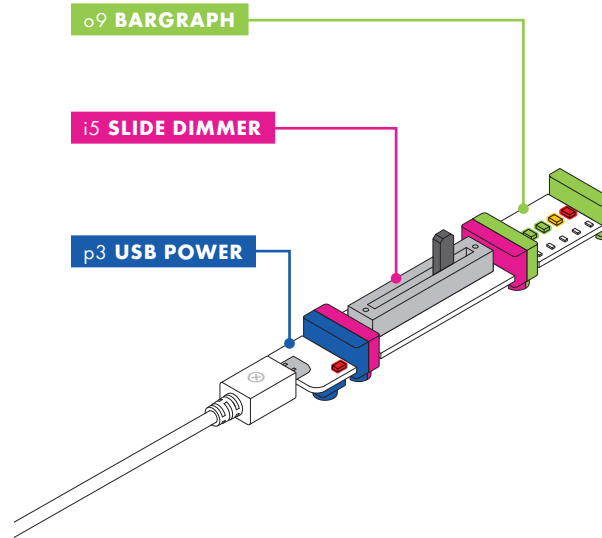

HOW IT WORKS

When the slider is all the way to the left, it's sending an off or 0 volt signal. When the slider is all the way to the right, it's sending a 5 volt signal. The slider can be positioned to send any signal between 0 and 5 volts.

REAL WORLD ANALOGIES



HOUSEHOLD DIMMER SWITCH



CAR PEDAL

i6 DIMMER

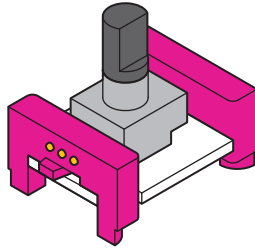

MEET THE BIT

Twist this dimmer back and forth to control your circuit. As you twist the dimmer clockwise, more signal goes to the Bits that follow, brightening lights, speeding up motors, or raising the volume on buzzers.

MINI-CHALLENGE

Can you invent a light that changes color?

SAMPLE CIRCUIT

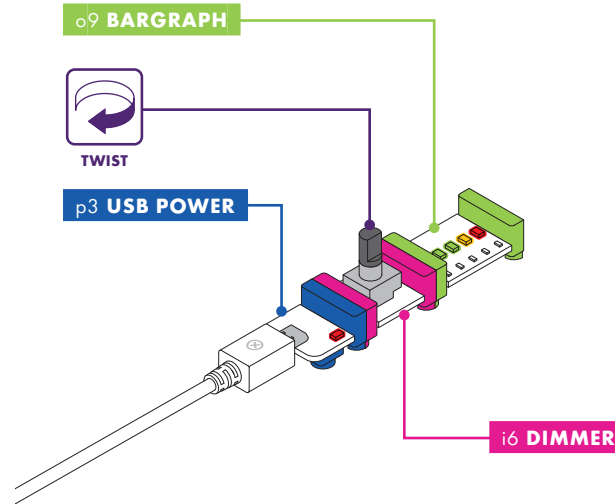

HOW IT WORKS

The dimmer is like the knob on a water faucet. The more you turn the knob, the more the water flows from the faucet. The dimmer is similar – the more you twist it clockwise, the more signal it lets through.

REAL WORLD ANALOGIES



HOUSEHOLD DIMMER SWITCH

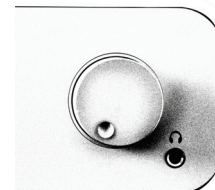

STEREO VOLUME CONTROL



FAUCET



STOVE KNOB

i11 PRESSURE SENSOR

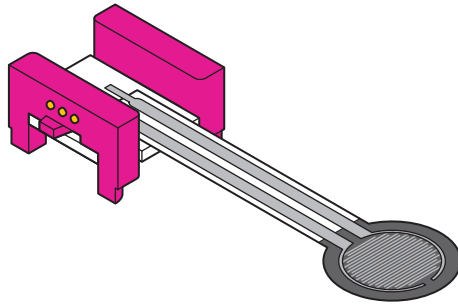

MEET THE BIT

The pressure sensor is a touch-activated Bit that responds to how much pressure you put on it.

MINI-CHALLENGE

Can you invent a light-up sign with the pressure sensor?

SAMPLE CIRCUIT

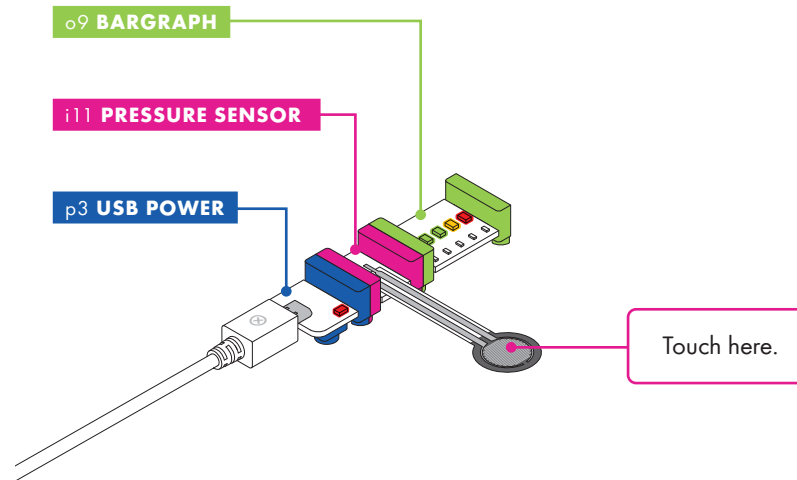

HOW IT WORKS

The pad of the sensor detects how much pressure is being applied. The harder you press down on it, the more signal it lets pass through to the following Bits.

Note: Do not fold or crease the pressure sensor.

REAL WORLD ANALOGIES



SCALE



TOUCH SCREEN



MICROWAVE TOUCH SCREEN



HAMMER CARNIVAL GAME

i20 SOUND TRIGGER

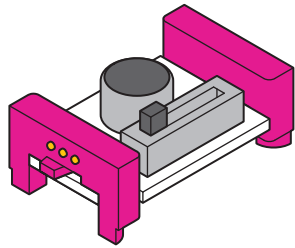

MEET THE BIT

Use this Bit to control your circuits with sound. It's a great way to make your inventions hands-free!

SAMPLE CIRCUIT

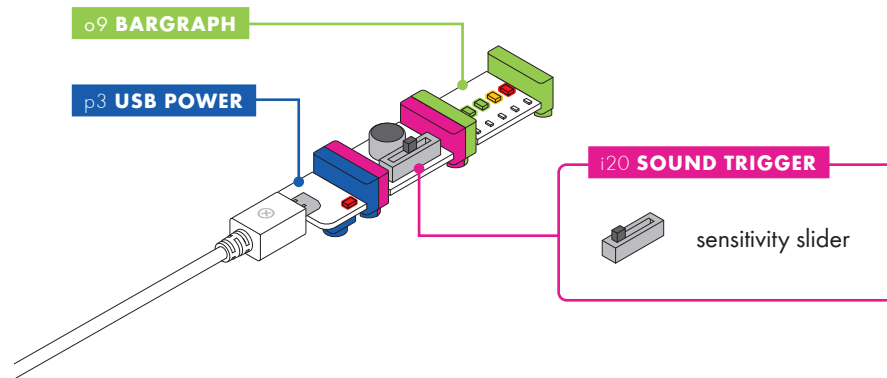

HOW IT WORKS

The sound trigger has a microphone that measures how much noise is around it. When the noise goes above a certain level, the sound trigger will send out a 5 volt signal to the Bits that follow. Use the adjustment slider to set the sensitivity (how much noise is needed to trigger your Bit).

MINI-CHALLENGE

Can you invent something that moves at the snap of your fingers?

REAL WORLD ANALOGIES



CLAP ON LIGHT



HUMAN EAR



BEAR IN HIBERNATION

w1 WIRE

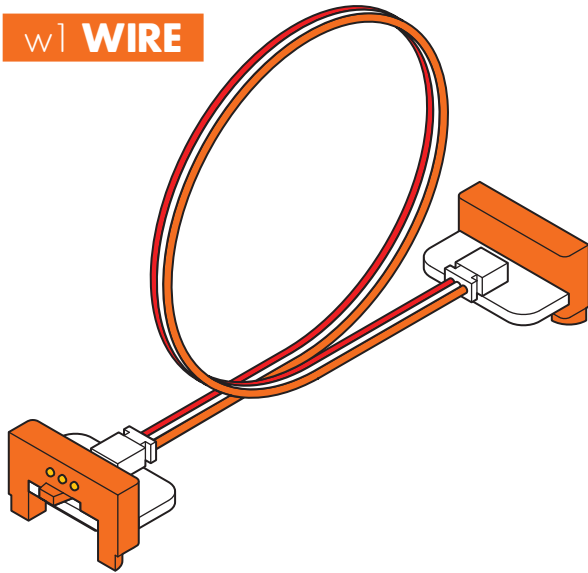

MEET THE BIT

The wire Bit has a flexible wire running between its two bitSnaps. This allows you to place your Bits farther apart, turn corners, and make connections that can twist, turn, and spin.

MINI-CHALLENGE

Can you invent a circuit that you wrap around your arm?

SAMPLE CIRCUIT

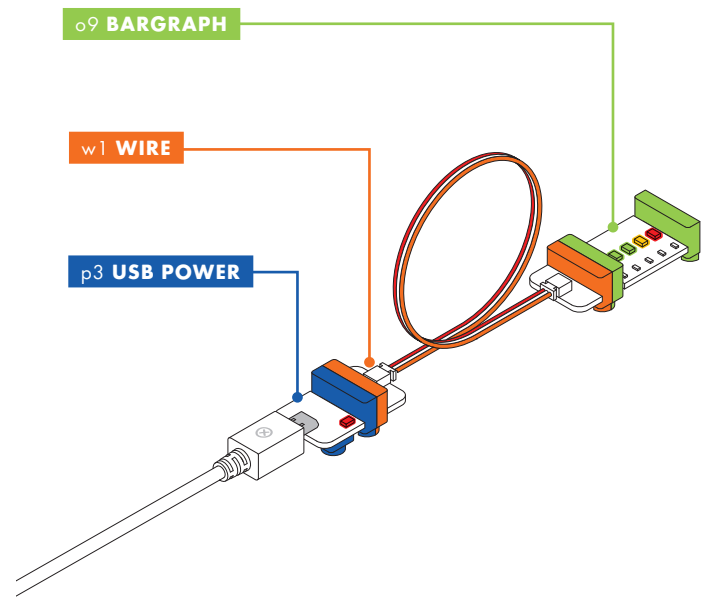

HOW IT WORKS

The wire doesn't change the signal in any way – it just carries it over from one Bit to another. Each wire Bit is 6 inches (15 cm) long.

REAL WORLD ANALOGIES



EXTENSION CORD



POWER LINES



PIPES



JUMPSTART CABLE

w2 BRANCH

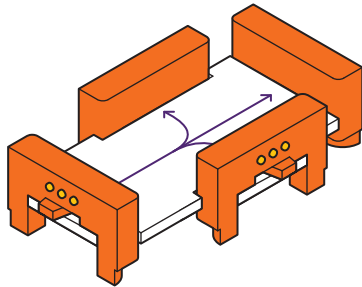

MEET THE BIT

The branch lets you send the same signal to up to 3 other outputs, in 3 different directions.

MINI-CHALLENGE

Can you invent a creature you control with one input Bit?

SAMPLE CIRCUIT

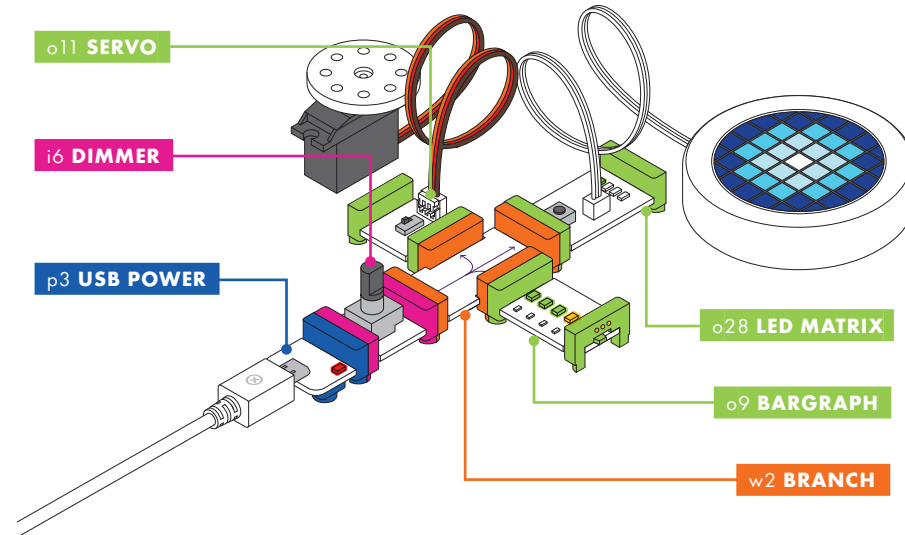

HOW IT WORKS

The branch takes the incoming signal and sends it equally to all 3 output bitSnaps.

REAL WORLD ANALOGIES



POWER STRIP



USB HUB



TREE BRANCH



FORK IN A RIVER

w26 CODEBIT™

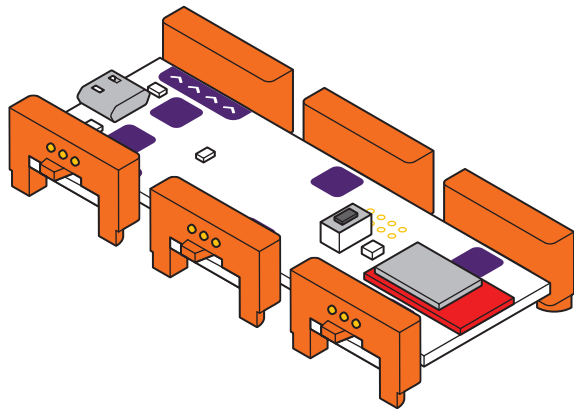

MEET THE BIT

The codeBit levels up your littleBits circuits by allowing you to program how your Bits work. Using the Fuse App, you can program this Bit to create unique sounds, movements, and animations.

MINI-CHALLENGE

Can you code a sound effect that plays at your command?

BIT BREAKDOWN

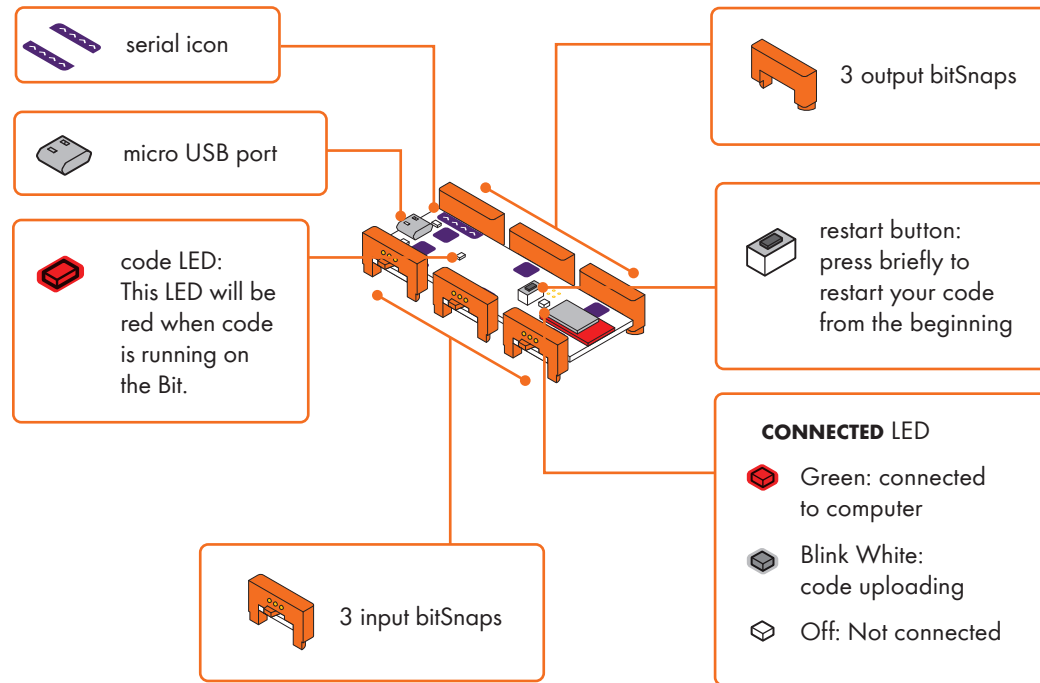

REAL WORLD ANALOGIES



COMPUTER



BRAIN



AIR TRAFFIC CONTROL



BAND CONDUCTOR

SAMPLE CIRCUIT

o26 SPEAKER

w26 CODEBIT

i3 BUTTON

p3 USB POWER

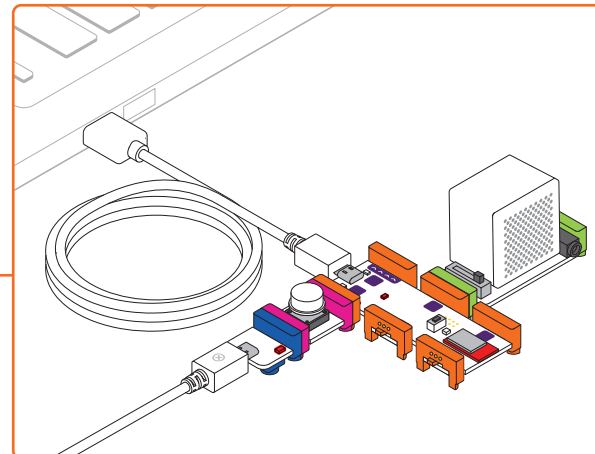

HOW IT WORKS

The codeBit is a miniature computer that you can use to control your circuit's behavior. You can program your codeBit to do different things by writing code in the littleBits Fuse app. When you're ready, you can instantly upload the code to your codeBit to see how it works.

Just like all other Bits, the codeBit needs to be connected to a power Bit in order to work. If you turn the power off, the Bit will stop working, but the code will still be on there and will start running when you turn the power back on.

For more information about the codeBit and an intro to all its features, visit classroom.littlebits.com

WHAT IS SERIAL?



Serial communication is a way to send complex information between computers and other devices. Serial communication is made up of a series of 'on' and 'off' signals.

For example, the codeBit can turn your code into serial data and send it to the LED matrix to tell it what to do.

Note: Only Bits with the serial communication icon are able to send and read serial data. Some Bits without the serial icon may interfere with serial signals if placed between the codeBit and the LED matrix.

09 BARGRAPH

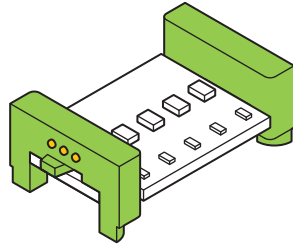

MEET THE BIT

The bargraph shows you how much signal the Bit is receiving with a display of five light-emitting diodes (LEDs) in different colors. Try it with a dimmer to make your own adjustable lamp.

MINI-CHALLENGE

Can you invent a way to show your mood to a friend?

SAMPLE CIRCUIT

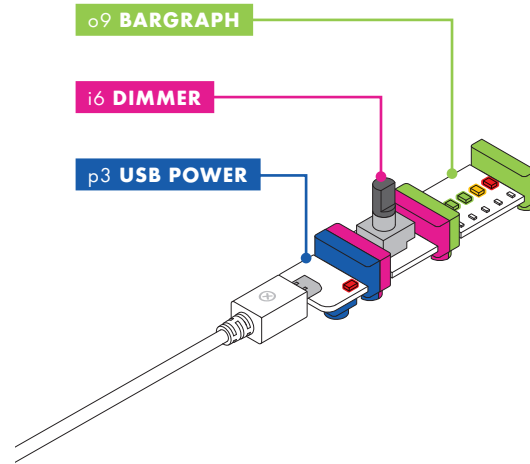

HOW IT WORKS

The bargraph uses five LEDs to turn electricity into light. Each LED on the board needs a certain amount of signal in order to light up. As you increase the signal sent to the bargraph, more LEDs will shine.

REAL WORLD ANALOGIES



MUSIC VISUALIZER



TV VOLUME



PHONE SCREEN BRIGHTNESS

o11 SERVO

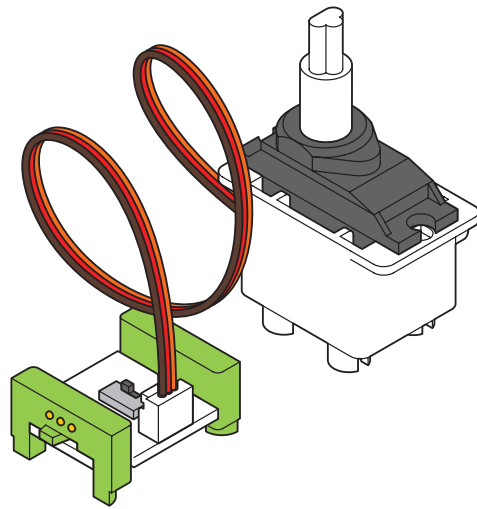

MEET THE BIT

The servo is a motor that can swing back and forth or be turned to a specific position.

There are a few accessories you can use with the servo (like the mechanical arm). You can find out how to use those on pages 24 and 25.

MINI-CHALLENGE

Can you invent something that uses the servo to clean up your desk?

SAMPLE CIRCUIT

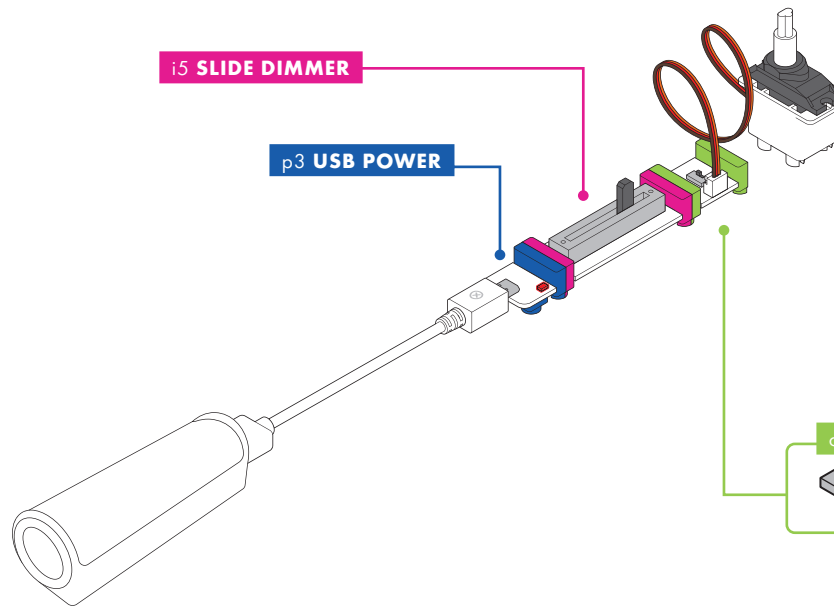

HOW IT WORKS

The servo has two modes. In **TURN** mode, the input from other Bits determines the position of the hub - try using a slide dimmer to set the angle you want. In **SWING** mode, the servo will move back and forth on its own like a pair of windshield wipers - the input signal controls the speed of the swing.

The servo's range of motion is about 110 degrees.

o11 SERVO



MODE: turn or swing

REAL WORLD ANALOGIES



TRUCK CRANE

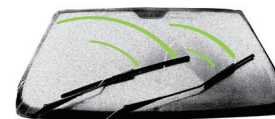

WINDSHIELD WIPERS

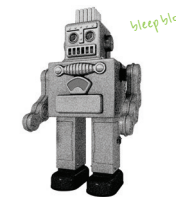

ROBOT

o26 SPEAKER

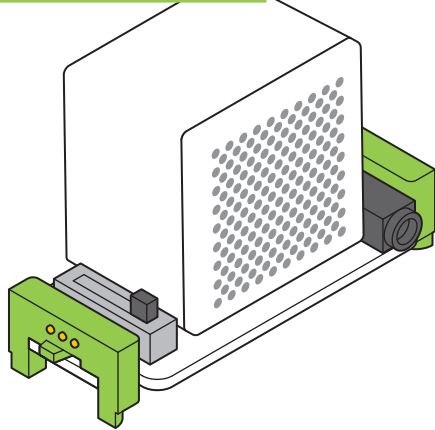

MEET THE BIT

Amplify your sonic explorations! The speaker Bit is a tiny speaker that lets you hear the signals coming from an oscillator, an MP3 player, or a codeBit. Pair it with these Bits to add music or sound effects to your inventions.

MINI-CHALLENGE

What is the strangest sound that you can invent?

SAMPLE CIRCUIT

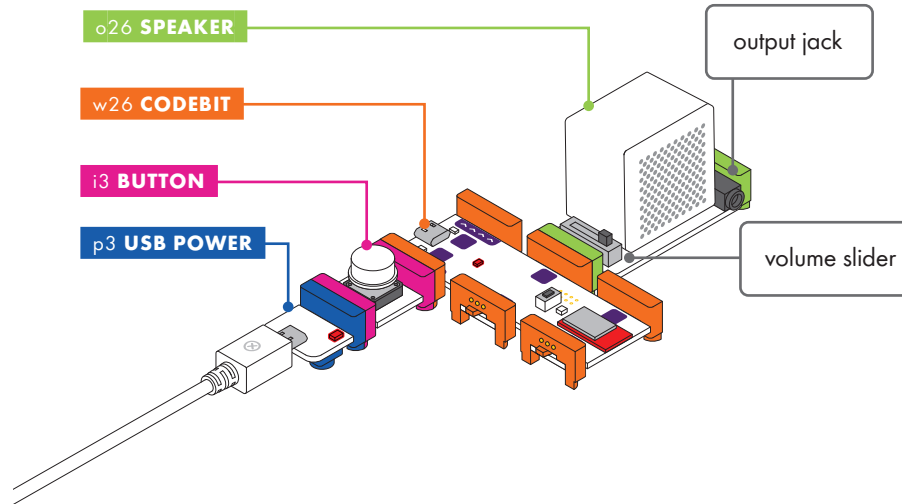

HOW IT WORKS

The speaker turns audio signals into vibrations that make sound. You can control the speaker's volume with a slider on the left side of the Bit. It also features an output jack on the right side of the Bit that you can connect to headphones, an amplifier, or a computer. When you connect to the output jack, sound will come out of the connected device (like your headphones) instead of through the speaker.

The speaker Bit will only make sound with Bits that create audio signals, such as the oscillator, MP3 player, or codeBit.

The speaker can be removed or repositioned on the board. To reattach, simply press together firmly.

REAL WORLD ANALOGIES



o29ROUND LED MATRIX

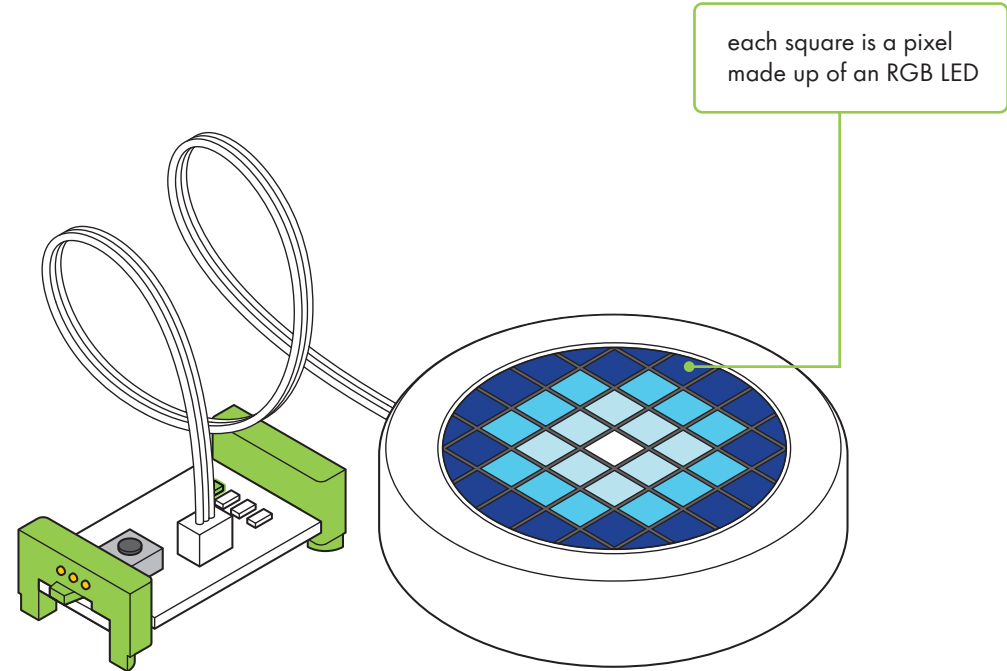
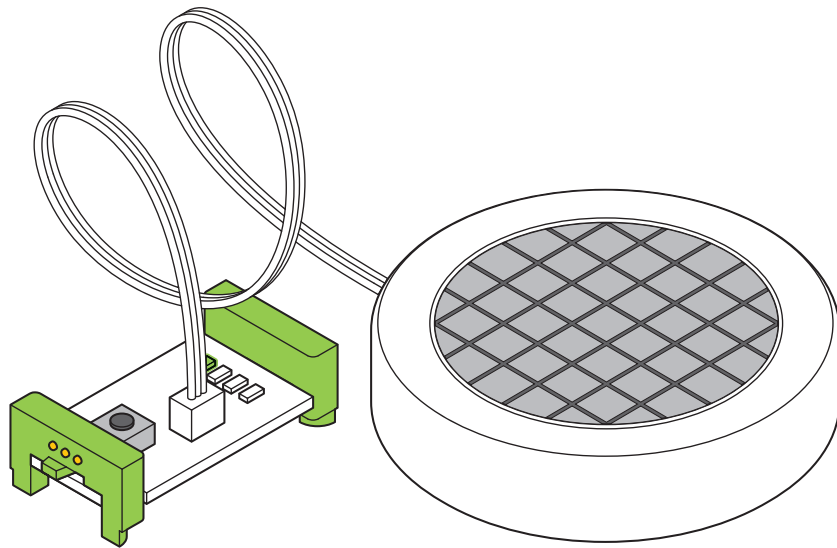

MEET THE BIT

The LED matrix is a colorful display that you can control using code or other Bits.

SAMPLE CIRCUIT #1

SIGNAL MODE

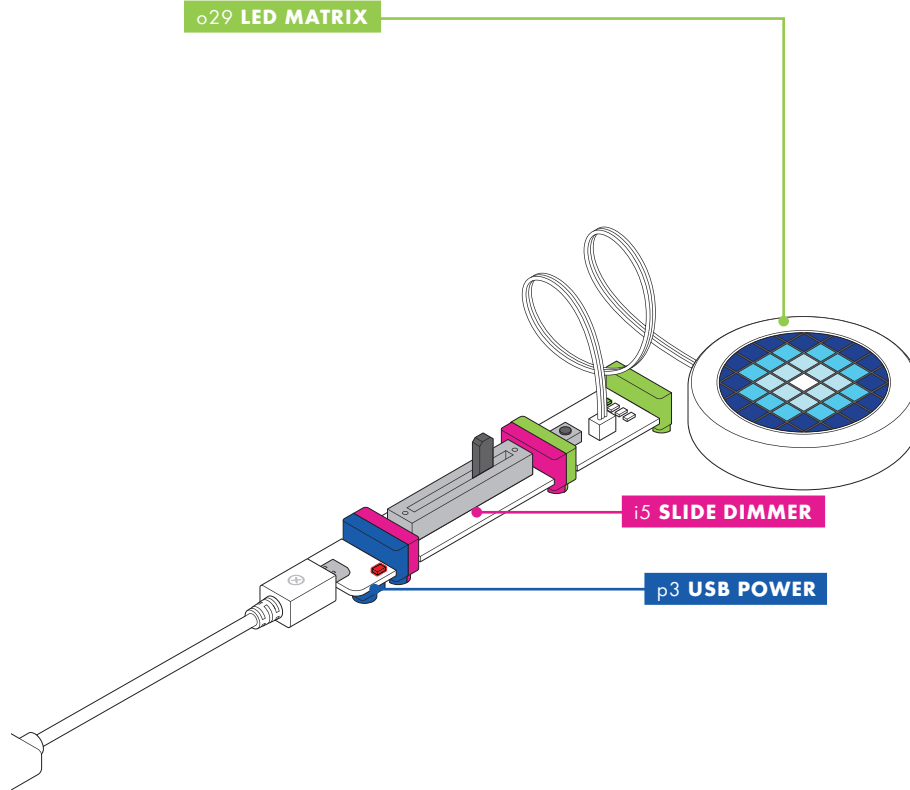

HOW IT WORKS

You can use different input Bits to control the amount of signal sent to the LED matrix. This will change the display depending on what preset you have selected. All presets require two inputs to fully control them.

For more information about **SIGNAL** mode, check out the LED matrix Tips & Tricks at classroom.littleBits.com

MINI-CHALLENGE

How many ways can you display a rainbow?

REAL WORLD ANALOGIES



SCROLLING SIGN BOARDS



SCOREBOARD



TV SCREEN



**WE INVENT THE WORLD
WE WANT TO LIVE IN.**



SAMPLE CIRCUIT #2

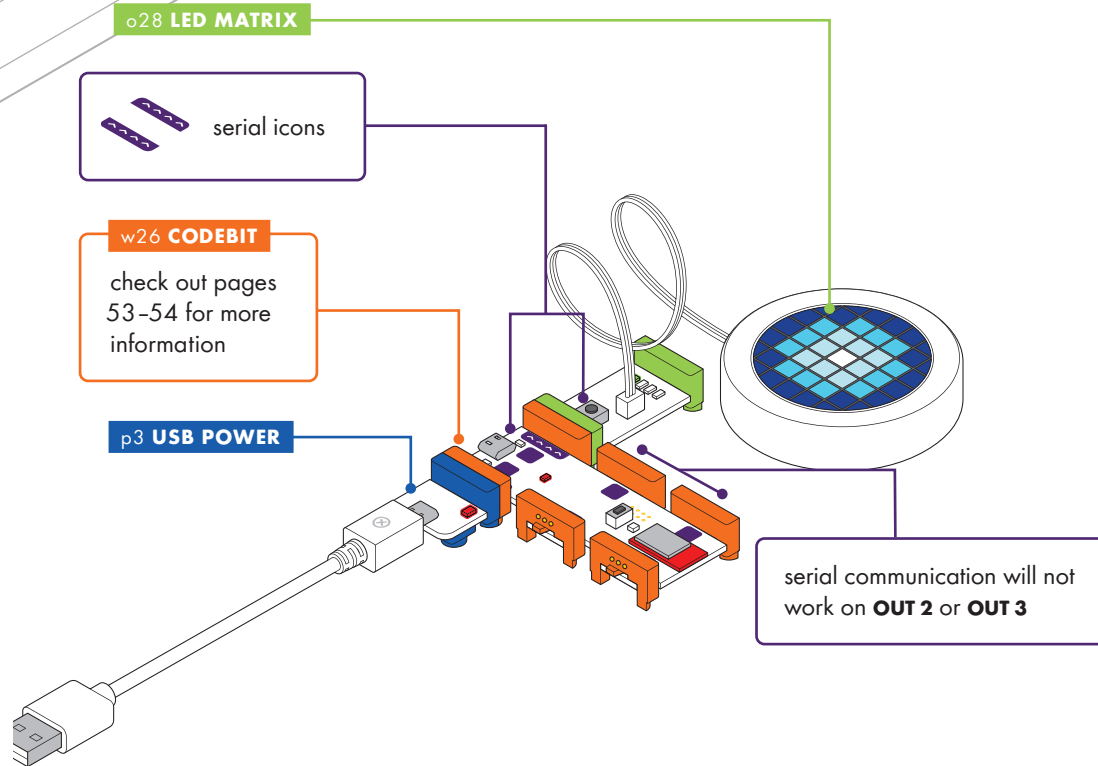

HOW IT WORKS

The LED matrix receives serial data, which it translates into images.

For more information about **SERIAL** mode, check out the LED matrix Tips & Tricks at classroom.itlBits.com

WHAT IS SERIAL?



Serial communication is a way to send complex information between computers and other devices. Serial communication is made up of a series of 'on' and 'off' signals.

For example, the codeBit can turn your code into serial data and send it to the LED matrix to tell it what to do.

Note: Only Bits with the serial communication icon are able to send and read serial data. Some Bits without the serial icon may interfere with serial signals if placed between the codeBit and the LED matrix.

a21 POWERSNAP

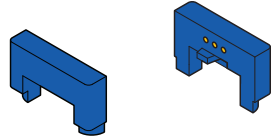

MEET THE ACCESSORY

The powerSnap supplies power to an open input without extra forks, splits, or power supplies.

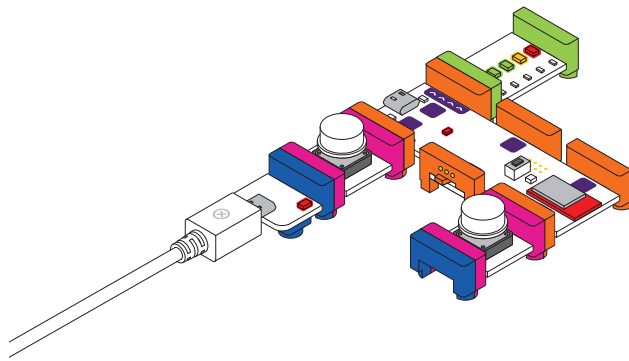

HOW IT WORKS

Every littleBits circuit needs power, and every Bit receives power through its input bitSnap. When using Bits with multiple inputs, like the codeBit, you can use powerSnaps to bring power to inputs not directly connected to the power Bit. The powerSnaps only work if you have a power Bit connected somewhere else in your circuit.

For more info on how power works in the littleBits system, check out littleBits.com/tips-tricks/powersnap

06 HOOK & LOOP SHOES

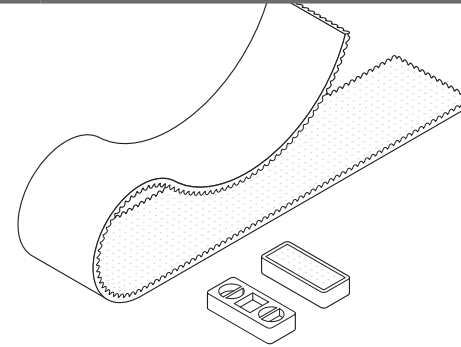

MEET THE ACCESSORY

Shoes slip onto your Bits' feet and hold your circuit together. On the bottom of your shoes you'll find hook & loops, which connect to the hook & loop strip. This is a great way to attach your circuit wherever you want.

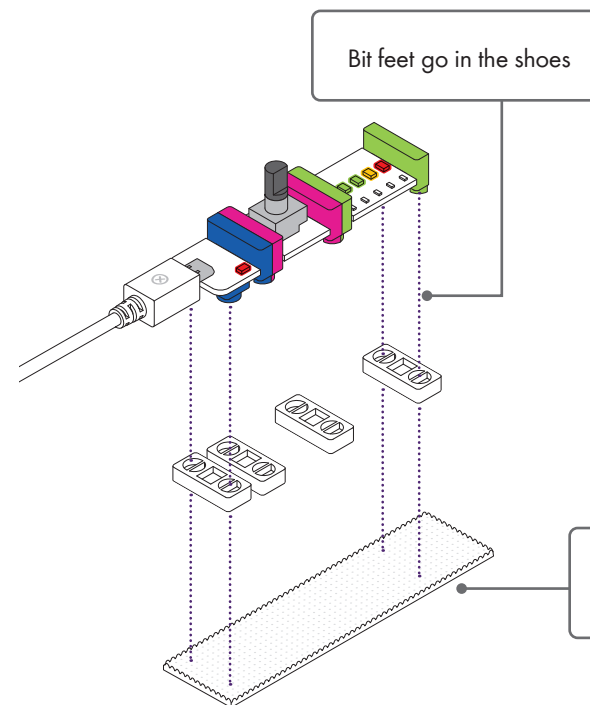

HOW IT WORKS

First, snap together your littleBits circuit. Then press the feet of your Bits into the holes of the shoes.

Hook & loop shoes come with an adhesive-backed hook & loop strip. The strip can be cut to any size you desire and affixed to clothing, fabric, or any other surface.

NOTE: The strip adhesive is for one-time use only.

a2 USB CABLE

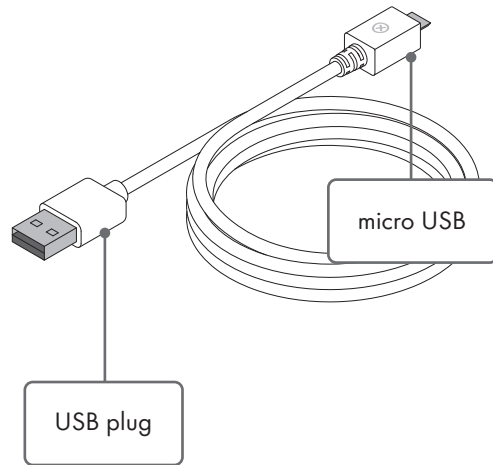

MEET THE ACCESSORY

The USB cable brings power to your USB power Bit and rechargeable battery. It will also send information between certain Bits and your computer. The cable comes in two lengths, 1'7" (0.5m) and 4'11" (1.5m), to fit your needs.

HOW IT WORKS

The cable acts like a bridge between the power source and what you're trying to turn on or charge. If you connect the USB plug to a power source, and the micro USB to the USB power Bit or rechargeable battery; power will flow from the source to the Bit or battery.

Likewise, the cable will also bridge certain Bits and your computer. If you connect the micro USB directly to Bits (like the codeBit), and the USB plug to your laptop, the cable will send information between the two.

Even though they are different lengths, both cables work the same.

a14 AC POWER ADAPTER

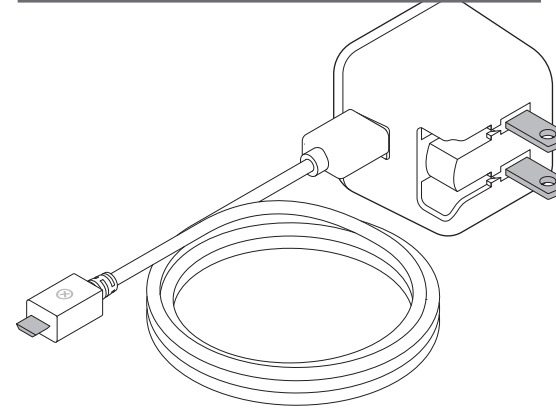

MEET THE ACCESSORY

This power adapter and USB cable combo is the perfect way to provide long-term power to your littleBits creations.

HOW IT WORKS

This power adapter converts your 100-240V AC wall power into the 5 volt power that littleBits circuits and the rechargeable battery run on. Simply connect a USB cable from the power adapter to your littleBits USB power Bit, or rechargeable battery.

NOTE: 100-240V AC 50/60Hz; Output: 5.0V DC 2000mA. Included adapter is for US electrical outlets only.

a27 RECHARGEABLE BATTERY

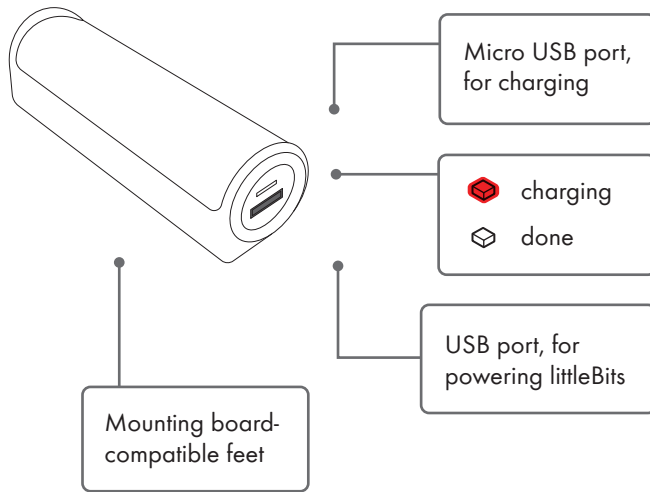

MEET THE ACCESSORY

The rechargeable battery is a portable power source for your inventions, which you can use over and over again.

HOW IT WORKS

To power your circuit, connect the USB plug to the charged battery, and the micro USB to the p3 USB power Bit.

To charge the battery, plug the micro USB of a cable into the battery and connect the USB plug to a computer or power adapter; see page 22 for more about the power adapter. The LED on the battery will shine red while charging, and be off when done.

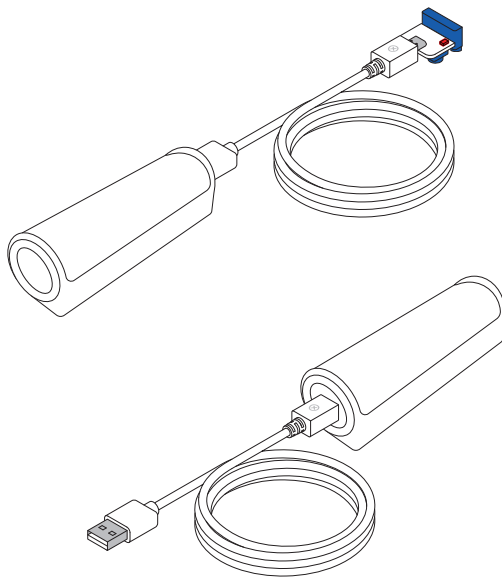

a24 SERVO MOUNT

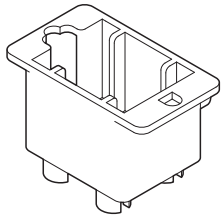

MEET THE ACCESSORY

The servo mount lets you attach your servo to a mounting board or a pair of littleBits shoes. With feet on two sides of the mount, you can orient the servo in all directions. It's a great way to keep the servo steady so the arm can go wild.

HOW IT WORKS

To use the servo mount: Carefully separate the white plug from the circuit board. Slip the plug through the vertical slot in the servo mount. Pull the wire through until the servo sits on top of the servo mount. Press the servo into the mount. Reconnect the white plug to the board.

For extra security, screw the servo to the mount using the included #6 screws.

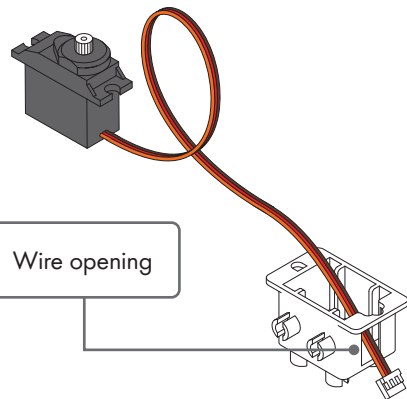

Connect to servo hub with included #6 screws, optional

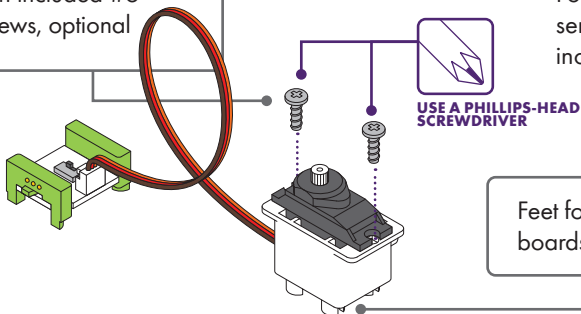

a19 SERVO HUB

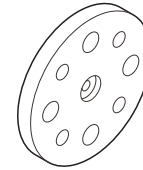

MEET THE ACCESSORY

The servo hub lets you easily attach materials to your servo motor and add more complex movements to your littleBits inventions.

HOW IT WORKS

The servo hub can be attached and removed by gently pushing or pulling it on or off the servo motor. This is helpful if you need to reorient how the holes are positioned for a project. The servo hub can be permanently attached by using the small screw (located in the servo accessory bag) in the center hole.

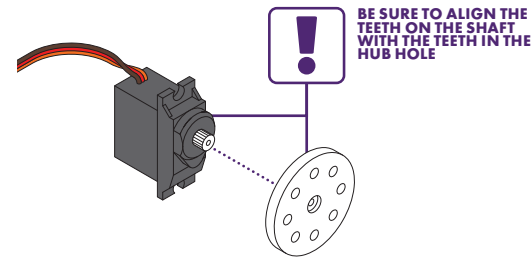

To attach anything to the hub, use the included #6 screws with any of these eight outer holes.

a23 MECHANICAL ARM

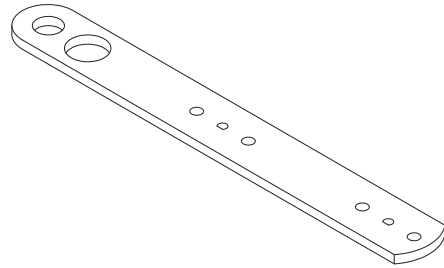

MEET THE ACCESSORY

The mechanical arm attaches to both the servo hub and the DC motor (not included) shaft, and offers lots of leverage for pushing, pulling, and throwing.

HOW IT WORKS

To attach the mechanical arm to the servo hub, use two of the #6 screws (included) and a Phillips-head screwdriver. Be sure to screw through the holes on the servo hub.

The two large holes on the end are perfect for holding pens and markers in place.

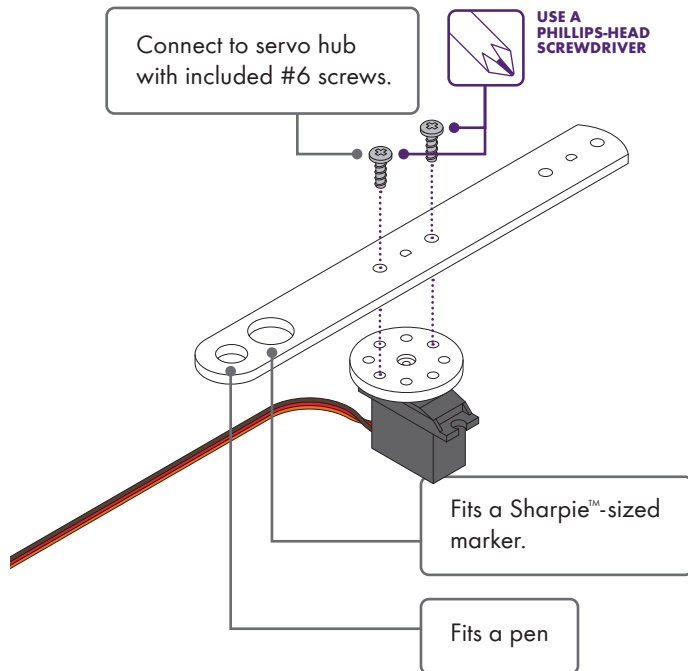

a28 MOUNTING BOARD (8" × 7")

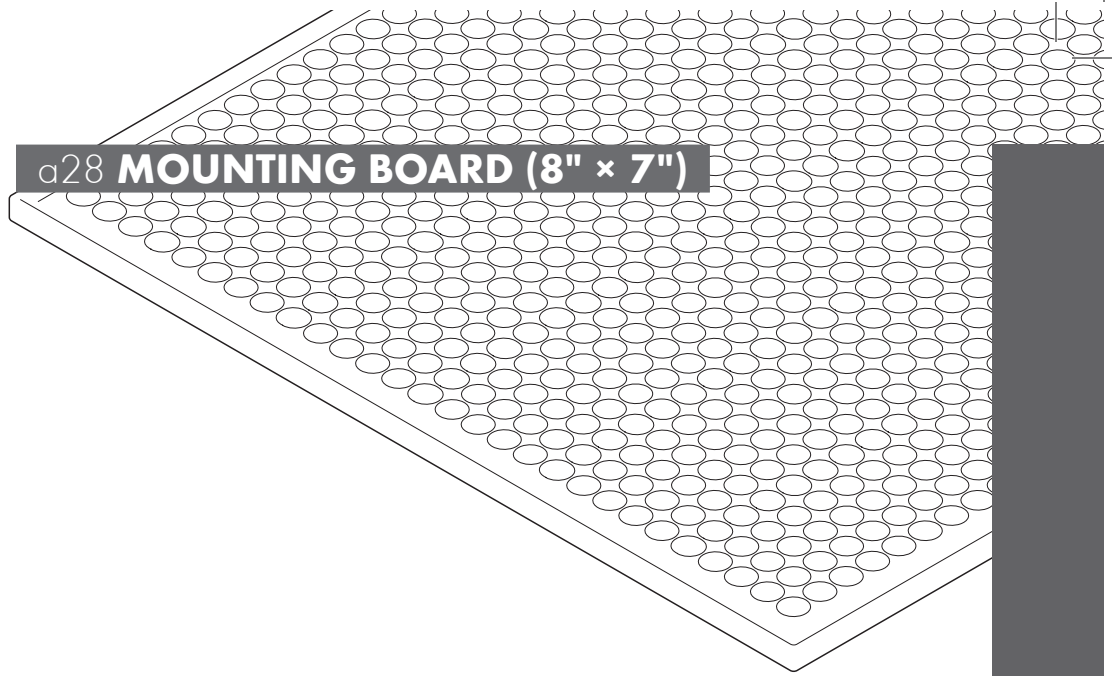

MEET THE ACCESSORY

The mounting board serves as the backbone of your inventions. It provides structure, and allows you to keep your circuit intact and move it around with ease. This mounting board can accommodate large circuits.

HOW IT WORKS

- 1 First, snap your circuit together.

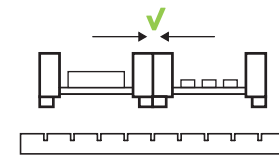

- 2 Next, press the circuit into the mounting board. ONLY press on the bitSnaps.

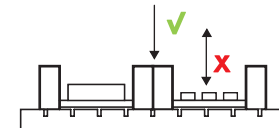

ALWAYS REMOVE BITS BY THE BITSNAP. DO NOT PULL ON CABLES TO REMOVE BITS FROM THE MOUNTING BOARD.

BITS NOT IN THIS KIT

p1 POWER

Every circuit starts with power. It provides electricity that makes Bits spin, buzz, blink, & shine.

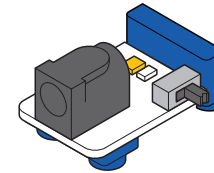

i1 SLIDE SWITCH

The slide switch is a small and convenient way to turn your creations on and off.

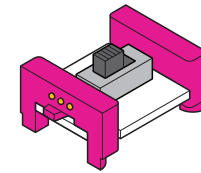

i2 TOGGLE SWITCH

The toggle switch is perfect for those inventions where you want a sturdy on-off switch.

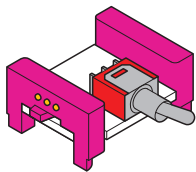

i7 REMOTE TRIGGER

The remote trigger allows you to send a signal to your circuit with a TV remote.

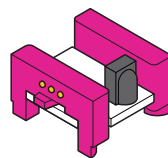

i12 TEMPERATURE SENSOR

The temperature sensor takes a measurement from the environment and translates it into a signal.

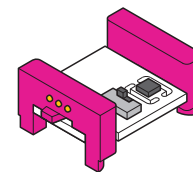

Use the temperature sensor to invent a **SMART FRIDGE.**

Get alerted if the refrigerator door has been left open for too long! Now your fridge will communicate with you when this happens so you can save your food.

i13 LIGHT SENSOR

Use this Bit to control your circuits with light.

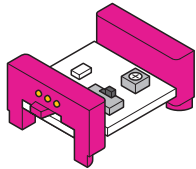

i14 BEND SENSOR

The bend sensor increases its signal the more you flex the long strip.

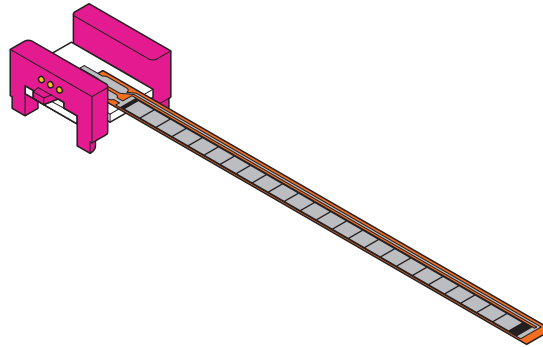

i16 PULSE

The pulse is a switch that opens and closes over and over again.

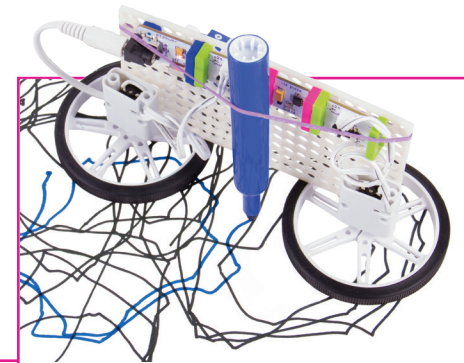
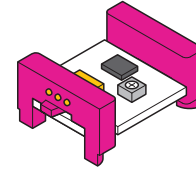

Use the pulse to invent an **ART MACHINE.**

Create a bot made with DC motors and a pulse that dances, wiggles, and draws up a storm. Add your own artistic flair by changing up some of the Bits and materials to create unique masterpieces.

i17 TIMEOUT

The timeout Bit is a settable timer between 0 and 5 minutes.

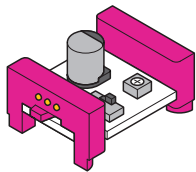

i18 MOTION TRIGGER

The motion trigger is a sensor that detects the slightest movement around it.

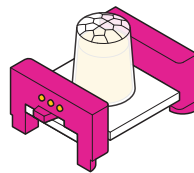

i19 ROLLER SWITCH

This Bit has a little lever with a wheel, and activates when something pushes the lever in or out.

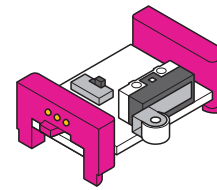

i21 MICROPHONE

Use this Bit to turn sounds into light or motion, or use it with the speaker Bit like a small megaphone.

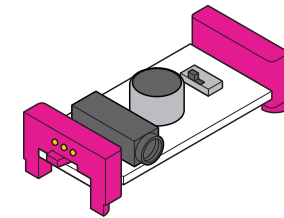

i22 SEQUENCER

This Bit lets you connect up to eight outputs and control them in sequential patterns.

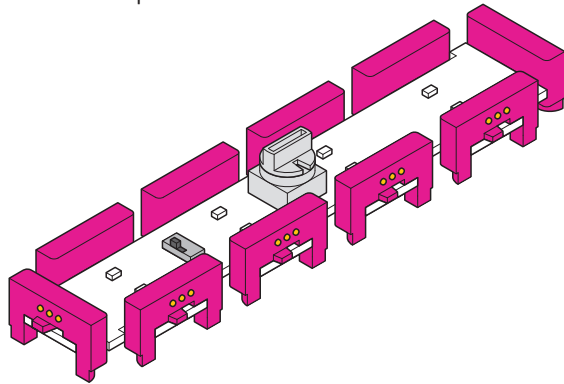

i23 THRESHOLD

Think of the threshold as a toll booth for signal passing through your circuit. You've got to have a certain amount of signal to get through!

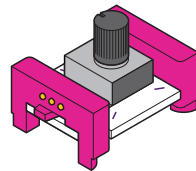

i25 MP3 PLAYER

The mp3 player allows you to play your very own mp3 files using littleBits.

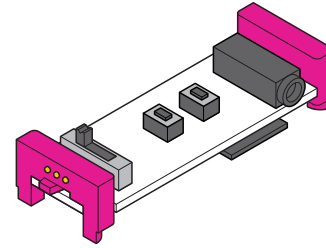

i30 KEYBOARD

The keyboard features 13 buttons that make an octave of notes so you can play melodies.

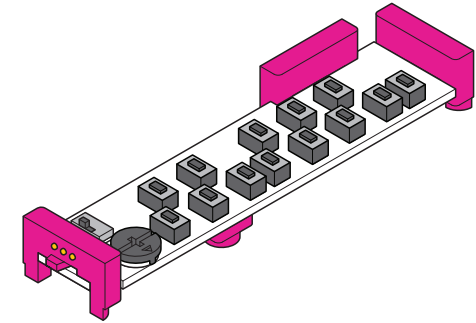

i31 OSCILLATOR

The oscillator creates audio tones that can be manipulated with its pitch knob and tune dial.

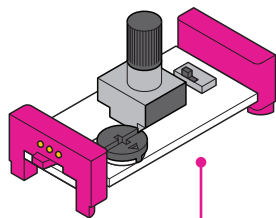

Use the oscillator to invent a **SYNTH KEYTAR.**

This electronic instrument uses a winning combination of Synth Bits starting with a micro sequencer, moving through a wire, an oscillator, a delay, and ending with the speaker!

i32 FILTER

The filter affects a note's timbre by changing the relative volume of certain frequencies.

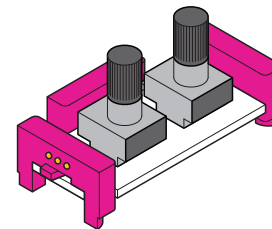

i33 ENVELOPE

The envelope modifies the loudness contour of a sound.

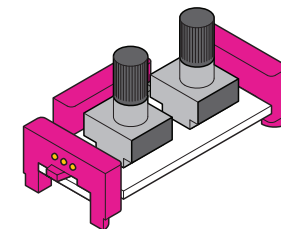

i34 **RANDOM**

This Bit has two modes: **NOISE** (white noise) and **RANDOM VOLTAGE**.

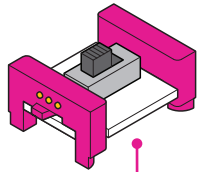

Use the random Bit to invent a **SPEECH PUPPET**.

This robot puppet speaks and moves! When the microphone is placed in front of him, the speaker moves his arms, speaks random sounds, and a light goes off in his head.

INVENTION BY Pantograph

i35 **DELAY**

The delay Bit takes incoming audio and repeats it, like an echo.

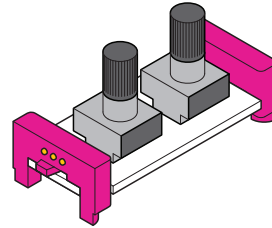

w3 **OR**

The OR Bit is a logic gate. The output is active if either of its two inputs are active.

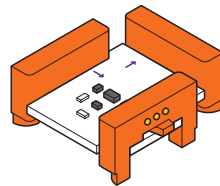

i36 **MICRO SEQUENCER**

The micro sequencer sends out voltages based on the position of each of the four knobs.

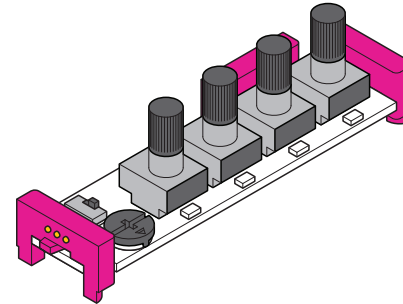

w4 **AND**

The AND Bit is a logic gate. The output is active if both of its two inputs are active.

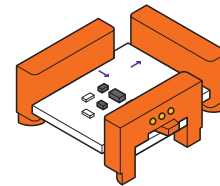

i37 **MIX**

The mix Bit allows you to combine two inputs and send them to a single output.

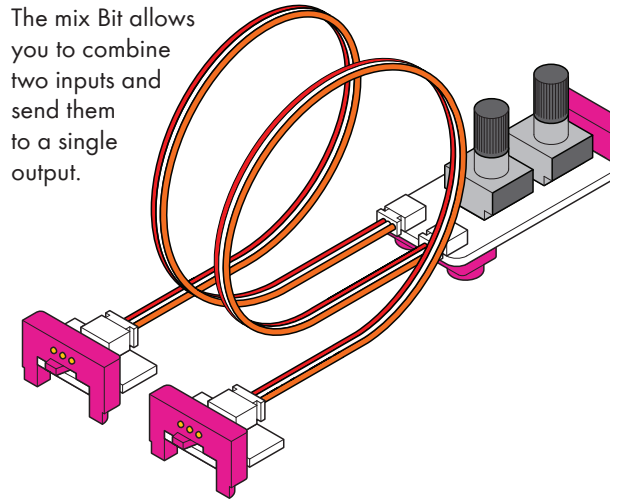

w5 **MIDI**

Send and receive MIDI messages with the MIDI Bit.

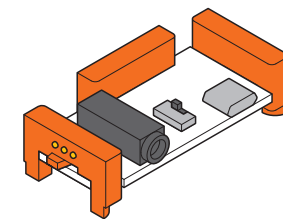

w7 FORK

Use the fork to connect a single Bit to as many as three others.

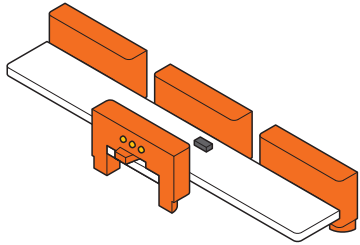

w8 LATCH

Use the latch to turn any momentary input into an ON/OFF switch, like a toggle.

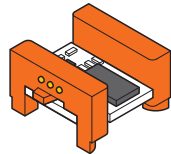

w9 PROTO

Use the proto Bit to build and prototype new Bits.

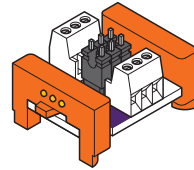

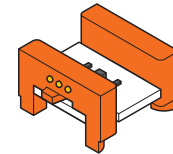

w10 INVERTER

The inverter sends out the opposite of whatever it receives.

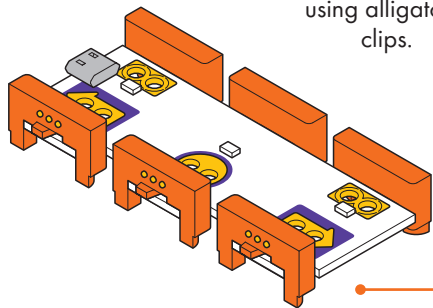

w14 MAKEY MAKEY® BIT

The Makey Makey Bit turns everyday conductive objects (like bananas) into triggers that control your circuit and even your computer. You can connect the Makey Makey Bit to these objects using alligator clips.

Use the Makey Makey Bit to invent a **BURGLAR BUZZER.** Invent your own burglar alarm that catches would-be thieves in the act! Protect your prized possessions with this automatic alerter that sounds and stays on when someone tries to take your stuff.

w15 NOR

NOR is a logic gate. The output is active if either one of its two inputs are inactive.

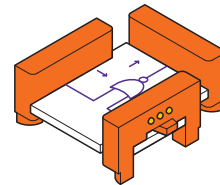

w16 NAND

NAND is a logic gate. The output is active if both of its two inputs are inactive.

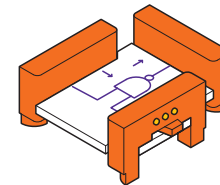

w17 XOR

XOR is a logic gate. The output is active if only one of its two inputs are active.

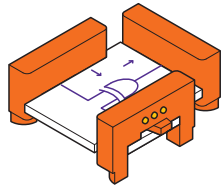

w18 CONTROL VOLTAGE

The control voltage lets you integrate your littleBits circuits with other analog synthesizers.

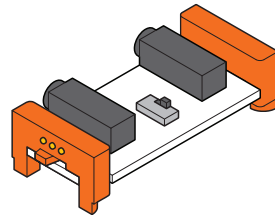

w19 SPLIT

The split lets you connect a single Bit to 2 others.

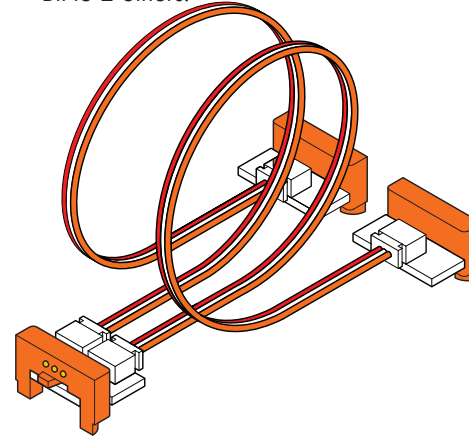

w20 cloudBit

The cloudBit allows you to connect all of your Bits to the internet and control them on the littleBits Invent App.

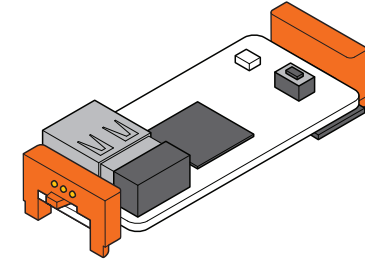

w27 USB I/O

The USB I/O Bit allows you to record digital audio directly into your computer.

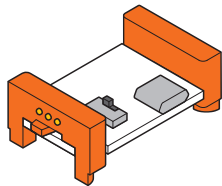

w29 PERF

The perf Bit is an easy way to prototype a new Bit to add to your littleBits collection.

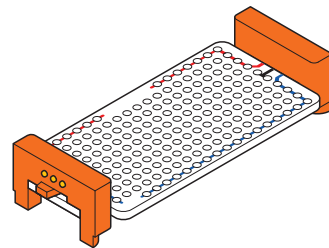

w30 BLUETOOTH® LOW ENERGY BIT

The Bluetooth Low Energy Bit can send and receive a signal from your smart device using Bluetooth Low Energy wireless technology.

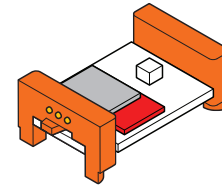

Use the Bluetooth Low Energy Bit to invent a **REMOTE CONTROL CAR.**

This bot was made to do your bidding from your smart device! Use this versatile vehicle to prank your pets, set up a snack delivery system for Mom, or turn your room into a race track!

01 LED

The LED (light-emitting diode) Bit is a small Bit that shines a green light.

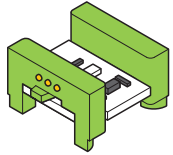

02 LONG LED

This flexible Bit uses an LED (light-emitting diode) to turn electricity into light.

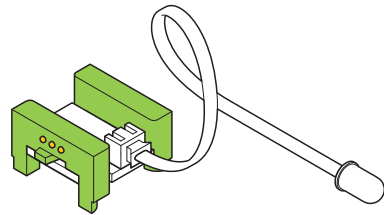

03 RGB LED

The RGB LED is a light with adjustable color. You can create a custom color mix of red, green, and blue.

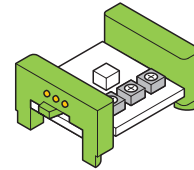

04 VIBRATION MOTOR

With the vibration motor Bit, you can make anything vibrate and buzz.

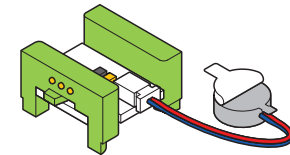

06 BUZZER

The buzzer converts the electrical signal it receives into a vibration, which creates a buzzing sound.

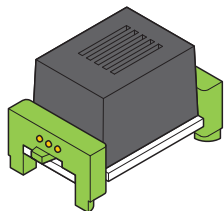

07 IR LED

The IR (infrared) LED Bit sends out light with longer wavelengths than visible light.

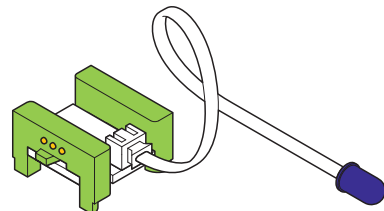

013 FAN

Use the fan to create a gentle breeze, perfect for cooling things off. You can also try taping small things (like stickers or pieces of paper) to the center of the fan for some spinning visuals.

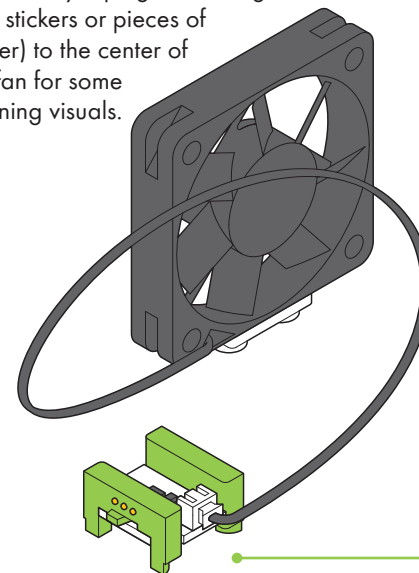

Use the fan to invent a **BUBBLE BLOWING BOT.**

Invent a bot that creates big, beautiful bubbles using only a few Bits and some items from around the house. Slowly move the slide dimmer to control how quickly the bubble grows. Can you make the ultimate bubble?

014 BRIGHT LED

The bright LED (Light-Emitting Diode) is a small Bit that shines out a big light.

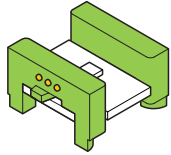

015 UV LED

The UV (ultraviolet) LED sends out a special kind of light. It looks purple to the eye, but it has some special abilities, like making white fabrics and certain inks glow in the dark.

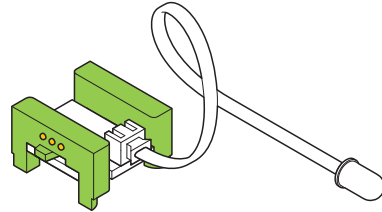

016 LIGHT WIRE

The light wire Bit is almost 4 feet long (1.2 m) and its entire length glows a soft blue.

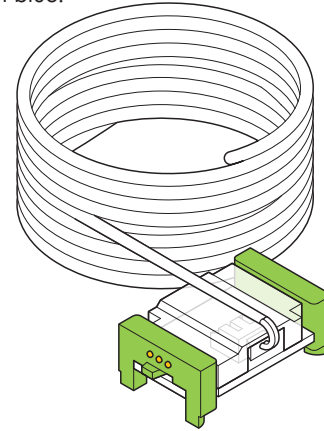

018 IR TRANSMITTER

The IR (infrared) transmitter sends a short pulse of modulated infrared light.

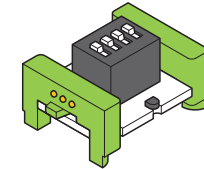

021 NUMBER

The number displays information that it receives from the Bits before it. It's a great way to measure the input from sensors or count things, like the score in a game.

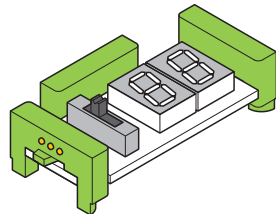

025 DC MOTOR

The DC (direct current) motor rotates a shaft when it receives a signal. The more signal it receives, the faster the motor will spin.

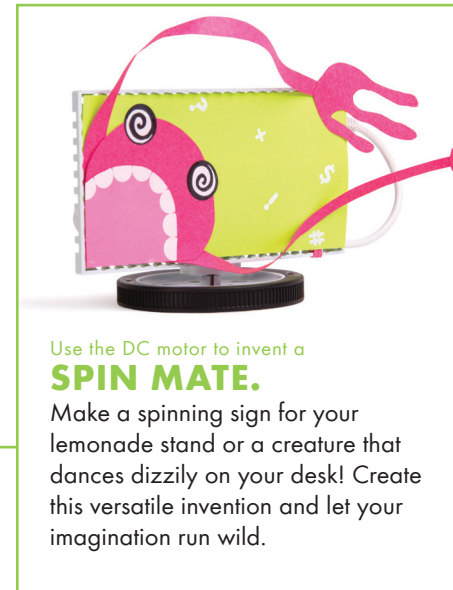
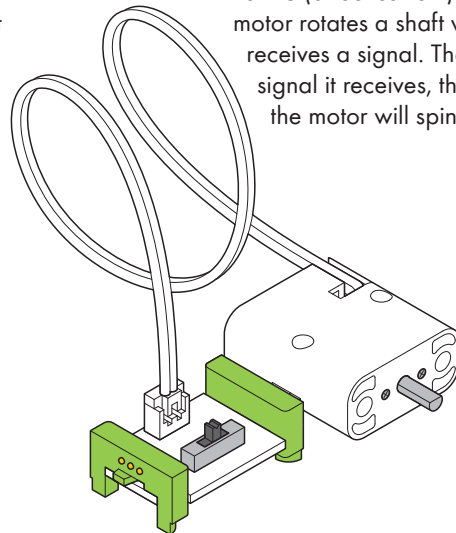

Use the DC motor to invent a **SPIN MATE.**

Make a spinning sign for your lemonade stand or a creature that dances dizzily on your desk! Create this versatile invention and let your imagination run wild.

THE LITTLEBITS™ INVENTION CYCLE

The littleBits Invention Cycle is a roadmap for your invention journey. Each phase is full of activities and questions that help you explore your ideas and develop your invention.

DO I HAVE TO GO THROUGH THE LITTLEBITS INVENTION CYCLE EXACTLY IN ORDER?

Nope! If you want, you can remix while you play or share while you create. Each phase of the invention cycle represents a different way of thinking and making. They work well in order, but a good design process is always a bit messy.



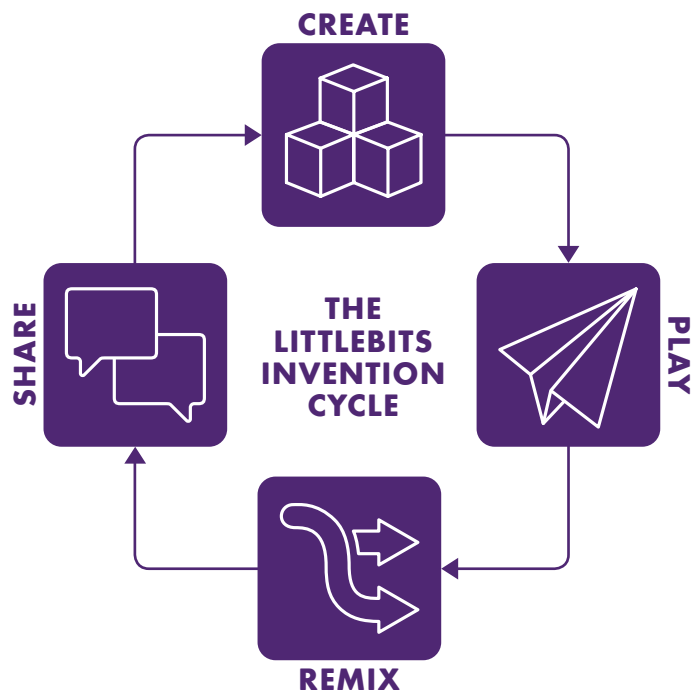

CREATE

PUT SOMETHING TOGETHER. You can build it from the instructions or make something from your imagination. Don't worry if it doesn't work or if it isn't perfect. The important thing is to create your first model so you have something to experiment with.

REMI

IMPROVE YOUR INVENTION. Keep experimenting! Add new Bits, swap parts with other inventions, or take all the pieces apart and put them together in a different way.

PLAY!

USE IT! Playing with what you've created is fun, but also an important part of inventing. Playing is like a test run. It's a chance to see how well your invention works and look for ways you can make it better.

SHARE

INSPIRE OTHERS. Show the world what you've created on the littleBits Invent app or at littleBits.com. Get inspired by exploring what others have shared. Create, play with, and remix other inventions. This is how awesome new inventions are born.

TROUBLESHOOTING



STILL HAVING TROUBLE?

Contact our Customer Success team at support@littleBits.com or check out our FAQ page at littleBits.com/faq.

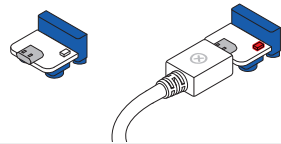

1 MAKE SURE YOUR POWER BIT™ IS PLUGGED INTO THE WALL WITH AN AC ADAPTER. If you're having trouble with your circuit, it's important to make sure your circuit is getting full power. The red LED should be illuminated on the power Bit when plugged in.

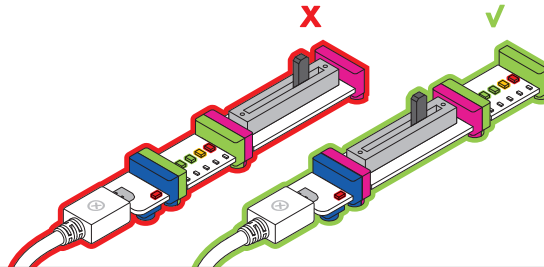

2 MAKE SURE YOUR BITS™ ARE ARRANGED IN THE PROPER ORDER AND ARE IN THE RIGHT MODE. Remember that you always need a power Bit at the start of your circuit and output Bit at the end. Some Bits also have different modes, and switching between them can help your circuit work correctly.

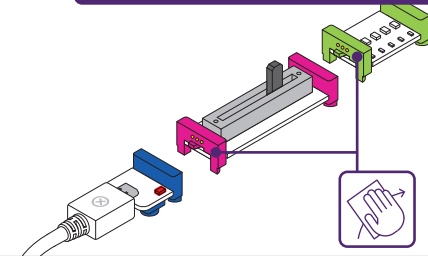

3 CHECK YOUR CONNECTIONS. Try gently wiping the ends of the bitSnaps in your circuit with a soft, clean cloth. Sometimes dust and dirt can get in the way of a strong connection.

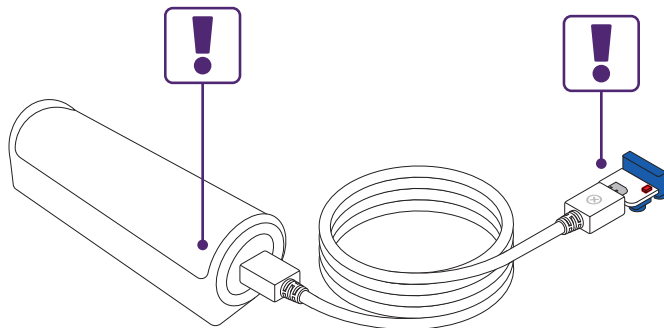

4 ENSURE THE POWER CABLE IS SECURELY FASTENED TO BOTH THE POWER BIT AND THE BATTERY.

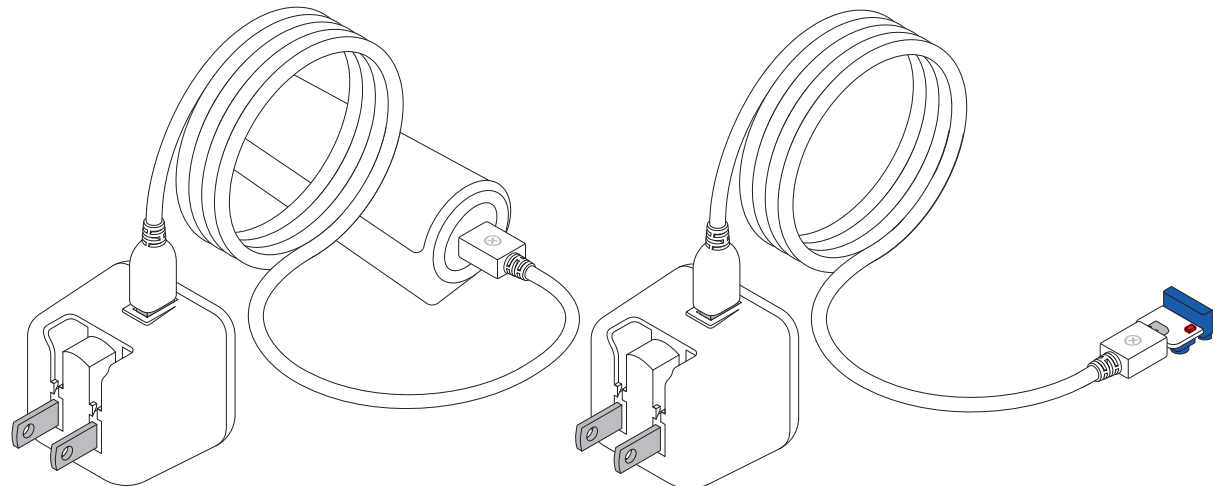

5 TRY CHARGING YOUR RECHARGEABLE BATTERY, OR USING THE AC WALL ADAPTOR. Low batteries can cause a circuit to act erratically. Bits have different power demands. For example: a motor may appear to not be working while a light still shines brightly.







a21
**POWER-
SNAP**

i11
**PRESSURE
SENSOR**

p3
**USB
POWER**

w1
WIRE

w1
WIRE

w1
WIRE

i3
BUTTON

i3
BUTTON

i20
**SOUND
TRIGGER**

i6
DIMMER

o9
**BAR-
GRAPH**

a24
**SERVO
MOUNT**

i5
SLIDE DIMMER

w2
BRANCH

o26
SPEAKER

**USB POWER
ADAPTER
CABLES (X2)**

o29
ROUND LED MATRIX

w26
CODEBIT

o11
SERVO

**HOOK & LOOP
SHOES (X12)**

 **littleBits**
**CODE KIT
CLASS PACK**

ACCESSORIES

Mechanical Arm
Hook & loop strip (x2)
Mounting Board
Rechargeable Battery
Servo Accessories
Servo Hub