



Connective Peripherals Pte Ltd

USB to Serial Converters Manual

Document Reference No.: CP_000032

Version 2.0

Issue Date: 2019-04-29

The ES-U-xxxx-x adapters are a series of USB Serial Converters from Connective Peripherals Pte Ltd. They provide a simple method of adapting legacy RS-232 or RS-422/485 devices to work with modern USB ports using a trusted and reliable FTDI chip set. Available in a variety of enclosures and port numbers, they are ideal for allowing factory automation equipment, multi-drop data collection devices, barcode readers, time clocks, scales, data entry terminals and serial communication equipment to be connected to USB ports in industrial environments.

This manual covers the following USB to Serial Converter products. For older products from the ES-U-xxxx-xx series please refer to the earlier version 1.4 of this manual available from the Connective Peripherals website.

| | | | |
|--------------|--------------|--------------|--------------|
| ES-U-1001-A | ES-U-1032-RM | ES-U-2002-M | ES-U-2101-MB |
| ES-U-1101-MB | ES-U-2001B | ES-U-2102-M | ES-U-3001-MB |
| ES-U-1002-A | ES-U-2101B | ES-U-2104-M | ES-U-3008-RM |
| ES-U-1002-M | ES-U-2001C | ES-U-2008-M | ES-U-3016-RM |
| ES-U-1008B | ES-U-2101C | ES-U-2016-RM | |

Connective Peripherals Pte Ltd
178 Paya Lebar Road, #07-03 Singapore 409030
Tel.: +65 67430980 Fax: +65 68416071

E-Mail (Support): support@connectiveperipherals.com Web: www.connectiveperipherals.com/products

Neither the whole nor any part of the information contained in, or the product described in this manual, may be adapted or reproduced in any material or electronic form without the prior written consent of the copyright holder. This product and its documentation are supplied on an as-is basis and no warranty as to their suitability for any particular purpose is either made or implied. Connective Peripherals Pte Ltd will not accept any claim for damages howsoever arising as a result of use or failure of this product. Your statutory rights are not affected. This product or any variant of it is not intended for use in any medical appliance, device or system in which the failure of the product might reasonably be expected to result in personal injury. This document provides preliminary information that may be subject to change without notice. No freedom to use patents or other intellectual property rights is implied by the publication of this document. Connective Peripherals Pte Ltd, 178 Paya Lebar Road, #07-03 Singapore 409030. Registered Number: 201617872E

Table of Contents

| | | |
|----------|--|-----------|
| 1 | Introduction | 4 |
| 2 | Specifications | 5 |
| 2.1 | Standard Features | 5 |
| 2.2 | Features by Model | 6 |
| 3 | Features of the ES-U-xxxx-x Family | 7 |
| 3.1 | USB and Serial Interface | 7 |
| 3.2 | Case Styles | 8 |
| 3.3 | Power Supply | 9 |
| 3.4 | Optical Isolation & Surge Protection | 10 |
| 3.5 | Configuring for RS-232, RS-422 and RS-485 Modes | 10 |
| 4 | Installing the Converter | 12 |
| 4.1 | Installation Steps | 12 |
| 4.2 | Windows 7 to Windows 10 | 12 |
| 4.3 | Verifying the Installation | 18 |
| 4.4 | Changing COM Port Properties and COM Number | 19 |
| 4.5 | OS Support - Linux, Mac and Older Windows Versions | 21 |
| 5 | Switch and Jumper Settings | 23 |
| 5.1 | General Notes and Warnings | 23 |
| 5.2 | ES-U-2x01B / ES-U-2x01C Adapters (Plastic Enclosure) | 24 |
| 5.3 | ES-U-2xxx-M and ES-U-2xxx-RM with 3 DIP Switches | 26 |
| 5.4 | ES-U-2xxx-M with 4 DIP Switches | 28 |
| 5.5 | ES-U-3xxx-x and ES-U-2101-MB | 29 |
| 6 | Connector Pinout Information | 32 |
| 6.1 | RS-232 Signal Pin-out | 32 |
| 6.2 | RS-422 Signal Pin-out | 35 |
| 6.3 | RS-485 Signal Pin-out (Half Duplex) | 38 |
| 6.4 | RS-485 Signal Pin-out (Full Duplex) | 40 |
| 6.5 | 5V Power Output (ES-U-1002-M only) | 42 |
| 7 | Troubleshooting | 43 |
| 7.1 | Hardware | 43 |

| | | |
|--|---|-----------|
| 7.2 | Removing existing FTDI drivers | 44 |
| 7.3 | Device Driver Options | 46 |
| 7.4 | Further Information on Resolving Driver Issues | 47 |
| 8 | Contact Information..... | 48 |
| Appendix A - List of Figures and Tables | | 49 |
| | List of Figures | 49 |
| | List of Tables..... | 49 |
| Appendix B - Revision History..... | | 51 |

1 Introduction

The ES-U-xxxx-x family of converters provide a quick and simple way to add serial communication ports to your computer. They connect to a single USB port on your computer to instantly provide up to 32 serial ports. They take advantage of the plug-and-play and hot-plug features of the USB bus to make it easier than ever to add communication ports to your system.

Installation is easy. There are no IRQ & COM port conflicts as the port doesn't require any additional IRQ, DMA or memory resources on the system. Each RS-232 or RS-422/RS-485 port functions as a native Windows COM port, and is compatible with Windows serial communication applications.

The ES-U-xxxx-x converters provide instant connectivity to RS-232 or RS-422/RS-485 compatible devices, including factory automation equipment, multi-drop data collection devices, barcode readers, time clocks, scales, data entry terminals and a variety of other devices in industrial environments.

This manual covers the following models:

USB to RS-232 converters

- Single channel (ES-U-1001-A, ES-U-1101-MB)
- Dual channel (ES-U-1002-A, ES-U-1002-M)
- 8-channel (ES-U-1008B)
- 32-channel (ES-U-1032-RM)

USB to RS-422/485 converters

- Single channel (ES-U-2001B, ES-U-2101B, ES-U-2001C, ES-U-2101C)
- Dual channel (ES-U-2002-M, ES-U-2102-M)
- Quad channel (ES-U-2104-M)
- 8-channel (ES-U-2008-M)
- 16-channel (ES-U-2016-RM)

USB to RS-232/422/485 converters

- Single channel (ES-U-3001-MB, ES-U-2101-MB)
- 8-channel (ES-U-3008-RM)
- 16-channel (ES-U-3016-RM)

2 Specifications

2.1

Standard Features

- Internal Transmit and Receive buffers
- Requires no IRQ, DMA, I/O port
- DB-9 male serial connectors (terminal blocks on some models) (see Note 1)
- LEDs for each port indicate TxD and RxD
- Virtual COM port drivers available
 - Windows 7 up to Windows 10
 - MAC OSX 10.9 onwards
 - Linux Kernel 3.0.0-19 (e.g. (Ubuntu version 11.10)
 - Other legacy drivers available from the FTDI website

USB to RS-232 Features (available on ES-U-1xxx and ES-U-30xx)

- Adds RS-232 ports via USB connection
- RS-232 data signals : DCD, RxD, TxD, DTR, GND, DSR, RTS, CTS, RI (See Note 2)

USB to RS-422/RS-485 Features (available on ES-U-20xx and ES-U-30xx) (See Note 3)

- Adds RS-422 / RS-485 ports via USB connection
- Auto transmit buffer control for 2-wire RS-485 half-duplex operation
- Internal termination and bias resistors on some models (enabled by jumper)
- RS-422 data signals : TX-, TX+, RX+, RX-, GND, RTS-, RTS+, CTS+, CTS- (see Note 2)
- RS-485 signals (half duplex) : Data+, Data-, GND
- RS-485 signals (full-duplex) : TX-, TX+, RX-, RX+, GND

Additional Opto-isolation Features (available on ES-U-11xx and ES-U-21xx)

- Each RS-232 or RS-422/RS-485 port is individually isolated with 2000 volt DC optical isolation
- Each RS-232 or RS-422/RS-485 port is individually protected by a surge protector to withstand electrostatic discharge and power surges up to 25KV ESD

Note 1 ES-U-1032-RM has RJ45 ports which can be converted to DB-9 male if required using the supplied cables

*Note 2 Terminal block has subset of these signals only – see section 6 for details
ES-U-2101-MB also features RS232 but only a subset of these signals – see section 6 for details*

Note 3 Support multiple serial protocols - Jumpers or DIP switches are used to select the required serial protocol

2.2 Features by Model

The table below summarises the features for each model in the ES-U-xxxx-x family.

| Model Number | Serial Interfaces | | | | Case | | Power Supply | Opto Isolated | Additional features and Notes |
|--------------|-------------------|-------|-------|-------|-------|------|--------------|---------------|---|
| | Ports | RS232 | RS422 | RS485 | Metal | Rack | | | |
| ES-U-1001-A | 1 | Y | - | - | - | - | USB | - | |
| ES-U-1101-MB | 1 | Y | - | - | Y | - | USB | Y | Revision B of ES-U-1101-M which supports higher data throughput |
| ES-U-1002-A | 2 | Y | - | - | - | - | USB | - | |
| ES-U-1002-M | 2 | Y | - | - | Y | - | USB | - | 5V 150mA output on 2-way screw terminal |
| ES-U-1008B | 8 | Y | - | - | - | - | USB | - | |
| ES-U-1032-RM | 32 | Y | - | - | Y | Y | Int | - | RJ45 serial connectors |
| ES-U-2001B | 1 | - | Y | Y | - | - | USB | - | Rev B of ES-U-2001 |
| ES-U-2001C | 1 | - | Y | Y | - | - | USB | - | Rev C of ES-U-2001 |
| ES-U-2101B | 1 | - | Y | Y | - | - | USB | Y | Rev B of ES-U-2101 |
| ES-U-2101C | 1 | - | Y | Y | - | - | USB | Y | Rev C of ES-U-2101 |
| ES-U-2101-MB | 1 | Y | Y | Y | Y | - | USB | Y | 6-way screw terminal |
| ES-U-2002-M | 2 | - | Y | Y | Y | - | USB | - | 5-way screw terminals |
| ES-U-2102-M | 2 | - | Y | Y | Y | - | USB | Y | ES-U-2002-M with isolation |
| ES-U-2104-M | 4 | - | Y | Y | Y | - | Ext | Y | 5VDC (2A) power adapter (barrel plug) * |
| ES-U-2008-M | 8 | - | Y | Y | Y | - | Ext | - | 12VDC (1.5A) power adapter (3-pin terminal) * |
| ES-U-2016-RM | 16 | - | Y | Y | Y | Y | Int | - | |
| ES-U-3001-MB | 1 | Y | Y | Y | Y | - | USB | - | 6-way screw terminal, 5V output Rev B of ES-U-3001-M which supports higher data throughput |
| ES-U-3008-RM | 8 | Y | Y | Y | Y | Y | Int | - | |
| ES-U-3016-RM | 16 | Y | Y | Y | Y | Y | Int | - | |

Table 1 - Features of the ES-U-xxxx-x converters

Power supply types are USB (USB powered), Ext (external power adapter) or Int (internal power supply)

* Power adapter voltages and currents shown in the comments column are for indication only and are subject to change. To avoid damage, always use the adapter which was provided with your converter to ensure that you are supplying the correct voltage for operation.

3 Features of the ES-U-xxxx-x Family

3.1

USB and Serial Interface

USB Interface

All devices in the ES-U-xxxx-x series feature a standard USB type-B socket. A standard USB A-B cable is supplied to connect to the PC.

Serial Interface

The ES-U-xxxx-x converters have DB-9 male connectors for connection to the RS-232/422/485 interface.

Some models have the following additional features:

- Terminal block connections providing a subset of the signals
- Optional 5V output.

The ES-U-1032-RM unit has RJ45 connectors on the front panel instead of DB-9, but is provided with adapter cables to convert these to DB-9 male connectors if required.



Figure 1 - DB-9 Male serial connectors. Some models also feature terminal blocks.



Figure 2 - ES-U-1032-RM (RJ45 connectors) is supplied with RJ45-to-DB-9 cables

3.2

Case Styles

The ES-U-xxxx-x converters are available in Plastic, Metal and Metal Rackmount enclosure styles. All units can be used on a desktop with the self-adhesive feet provided.

- Plastic case desktop converters are supplied with USB cable and (when required depending on model) power adapter localised to country of sale.
- Metal case converters are supplied with wall mounting hardware, USB cable and power adapter with plug localised to country of sale (when required depending on model).
- Metal rack mount converters are supplied with rack mounting hardware, USB cable and power cable localised to country of sale.

Transmit and receive LEDs for each port are included on the front or top panel of the enclosure, to show when data is being transmitted or received by the associated port. A power LED is also included (on units with metal enclosures) to show that the converter is receiving power.



Figure 3 - Example of the Metal Rack-mount enclosure



Figure 4 - Examples of the Plastic and Metal (wall mountable) enclosures

3.3

Power Supply

Depending on the model, power will either be supplied from the USB port, from an external power adapter or from an internal switching supply. The different types are described below. Table 1 on page 6 shows which type of power supply is required for each converter model.

USB powered

These devices are powered directly from the USB port. No power supply is required for these converters. It is recommended to connect them direct to a PC's USB port. If necessary to use a USB hub, it is strongly recommended to use a self-powered hub (which has its own PSU) as bus-powered hubs may not be able to provide sufficient power.

Power Adapter

These devices are provided with an external power adapter in the package. The adapter supplied has a UK, EU or USA plug depending on the country of sale and so may vary from the one shown below. The low voltage connector is either a 3-pin terminal block connector or a barrel-type jack as shown below, depending on the model. For more details, see Table 1 on page 6.

The low voltage cable should be connected to the power (or DC in) socket on the converter, and the AC input plug should be connected to a power source before using the converter.



Always use the supplied adapter to power your ES-U-xxxx-x converter; damage will occur if an adapter providing the wrong voltage is used and is not covered by the warranty.



Figure 5 - Some models use a power adapter with barrel or terminal connector

Internal Switching Power Supply

The rack mountable (ES-U-xxxx-RM) devices require an AC input (100V ~ 240V, 47 – 63 Hz) for the internal switching power supply. A power cable is supplied with the converter, and connects to the power inlet socket on the rear panel. The cable has a UK, EU or USA plug depending on the country of sale and so may vary from the one shown below.



ES-U-2016-RM

Figure 6 - Rack-mount models have an internal supply with AC input connector

3.4

**Optical
Isolation &
Surge
Protection**

Optical isolation and surge protection are available in the ES-U-11xx and ES-U-21xx converters.

Each serial port is individually optically isolated with 2000 volt DC optical isolation. The optical isolation protects your PC or notebook from spikes and surges on the RS-232 or RS-422/RS-485 network, by converting the electrical data into an optical signal and then changing it back into electrical data. Your computer is well protected, since the surges and spikes cannot cross the optical link.

Each serial port is individually protected by surge protector to withstand electrostatic discharge and power surges up to 25KV ESD.

3.5 Configuring for RS-232, RS-422 and RS-485 Modes

The ES-U-2xxx-x and ES-U-3xxx-x converters can be configured for different interface types. These converters have DIP switches or internal jumpers to select the required interface. They also feature internal jumpers to select options such as termination and biasing of the RS-422 and RS-485 lines.

Please refer to section 5 for more information on the DIP switch and jumper settings available on each model of converter.



ES-U-3008-RM

Figure 7 - ES-U-2xxx and ES-U-3xxx have DIP switches to select the serial mode

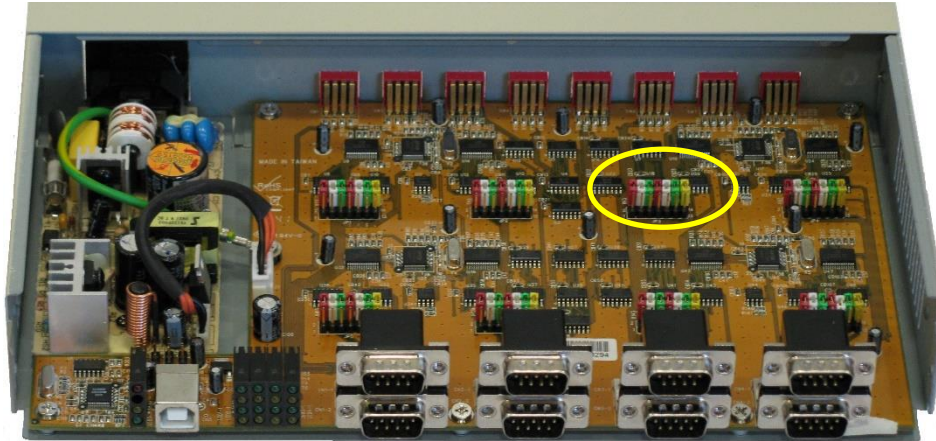

Figure 8 - ES-U-3008-RM has a set of jumpers for each port (one set circled)

4 Installing the Converter

4.1

Installation Steps

The main steps in configuring your converter are as follows:

1. Configure the switches and jumpers on your converter to match your serial bus type. See section 5 for details of the settings for your particular model of converter.

Do not connect the converter to the power supply, the PC USB port or the RS-232/422/485 serial network at this stage. Note that ES-U-1xxx-x converters do not have any DIP switches or jumpers and you can proceed to step 2 immediately.

2. Install the drivers for the converter on your computer. Refer to section 4.2 for Windows 7 up to Windows 10. For other OS please refer to section 4.5.

Note that if older FTDI drivers are already present on your system, see section 7.2 for details on how to remove them before proceeding to install the driver.

3. Verify the installation (see section 4.3)
4. If you encounter issues, see section 7 for troubleshooting information.

4.2

Windows 7 to Windows 10

The driver installation can be done using either the *Driver Executable* or the *Windows Update* method below.



You need to have administrator privileges to install any new drivers in Windows. To install the driver or update the configuration please log onto Windows as "Administrator" or ask your system administrator to install the USB to serial driver.

Option1 - Driver Executable

The driver executable provides a fast and easy installation.

- a. Download the latest version of the driver setup executable file from the following link. **Version 2.12.28 was the latest driver executable available when this manual was published (as circled below), but please check the link to the driver page below before installing your converter and use the latest version.**

<http://www.ftdichip.com/Drivers/VCP.htm>

To download the file, go to the comments column and right-click on the link "Setup Executable"

| Operating System | Release Date | Processor Architecture | | | | | | | Comments |
|-------------------------|--------------|--|--------------|--------|--|----------|----------|----------|---|
| | | x86 (32-bit) | x64 (64-bit) | PPC | ARM | MIPSII | MIPSIV | SH4 | |
| Windows* | 2017-08-30 | 2.12.28 | 2.12.28 | - | - | - | - | - | WHQL Certified. Includes VCP and D2XX. Available as a setup executable. Please read the Release Notes and Installation Guides . |
| Linux | - | - | - | - | - | - | - | - | All FTDI devices now supported in Ubuntu 11.10, kernel 3.0.0-19. Refer to TN-101 if you need a custom VCP VID/PID in Linux. VCP drivers are integrated into the kernel. |
| Mac OS X 10.3 to 10.8 | 2012-08-10 | 2.2.18 | 2.2.18 | 2.2.18 | - | - | - | - | Refer to TN-105 if you need a custom VCP VID/PID in MAC OS |
| Mac OS X 10.9 and above | 2017-05-12 | - | 2.4.2 | - | - | - | - | - | This driver is signed by Apple |
| Windows CE 4.2-5.2** | 2012-01-06 | 1.1.0.20 | - | - | - | 1.1.0.10 | 1.1.0.10 | 1.1.0.10 | |
| Windows CE 6.0/7.0 | 2016-11-03 | 1.1.0.22 CE 6.0 CAT CE 7.0 CAT | - | - | 1.1.0.22 CE 6.0 CAT CE 7.0 CAT | 1.1.0.10 | 1.1.0.10 | 1.1.0.10 | For use of the CAT files supplied for ARM and x86 builds refer to AN_319 |
| Windows CE 2013 | 2015-03-06 | 1.0.0 | | | 1.0.0 | | | | VCP Driver Support for WinCE2013 |

Figure 9 Driver download from FTDI website

Note: If you wish to install the converter on a computer which is never connected to the internet, you can download the file using another computer and use a USB flash drive or similar to copy the file over to the computer which will be used with the converter.

- Un-zip the file to extract the executable installer CDM21228_Setup.exe (for example, this can be done by right-clicking the downloaded CDM21228_Setup.zip file and selecting "Extract All...") and selecting a suitable folder. By default, Windows will create a folder with the extracted files in it. Then browse to the folder which was created during the un-zip process.
- Right-click on the CDM21228_Setup.exe file and select 'Run as Administrator' to ensure that the program is run with administrator privileges.
- Windows may display the warning below. This is just to notify you that you are running a file which was downloaded from the internet. If this appears, click 'Yes'.

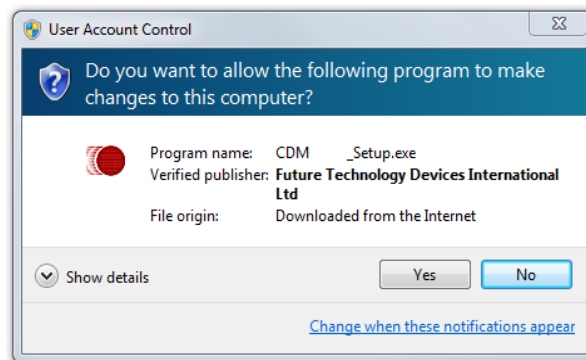

Figure 10 User account control

- The driver install wizard will appear as shown below. Click 'Extract' to proceed.

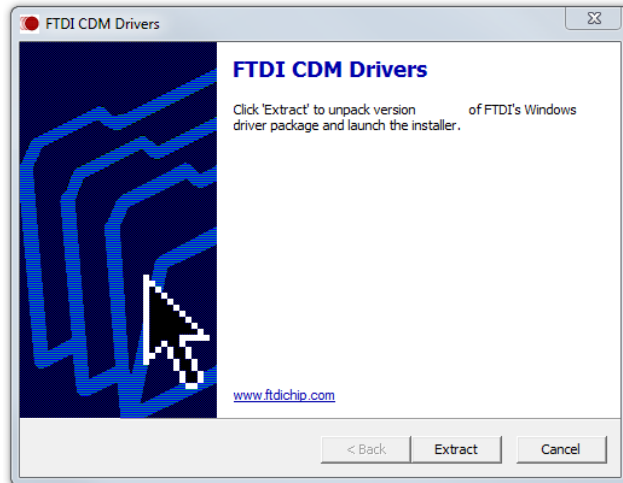

Figure 11 Install Wizard initial window

- e. Windows will now extract the files provided in the setup program.

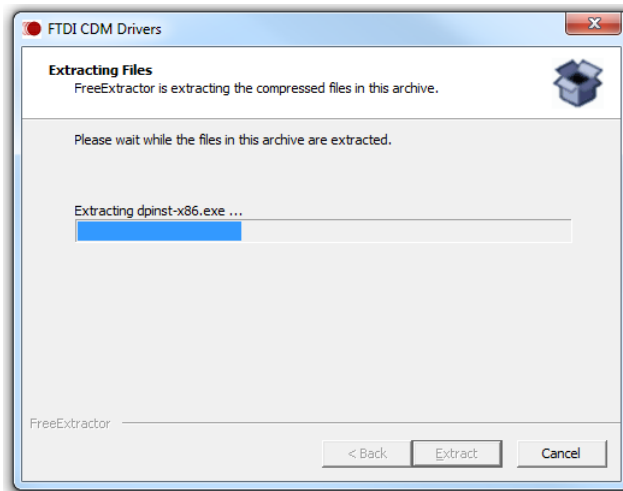

Figure 12 Install Wizard – extracting files

- f. Click 'Next' to begin installing the driver.

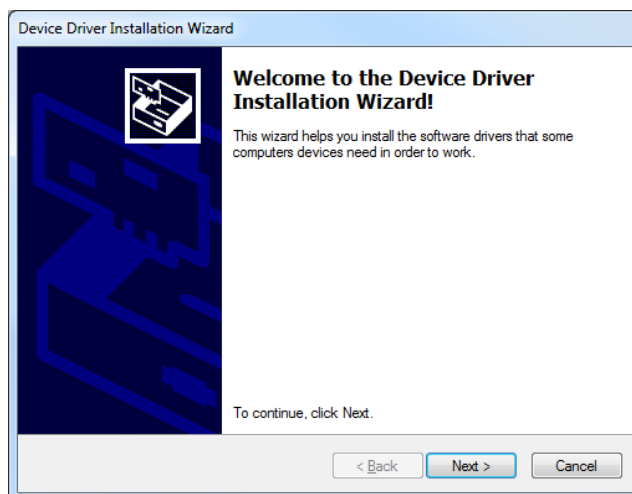

Figure 13 Install Wizard – ready to install

- g. You must review the license terms shown before installing the driver, and then select the appropriate radio button. By proceeding with the installation, you confirm your acceptance of these terms.

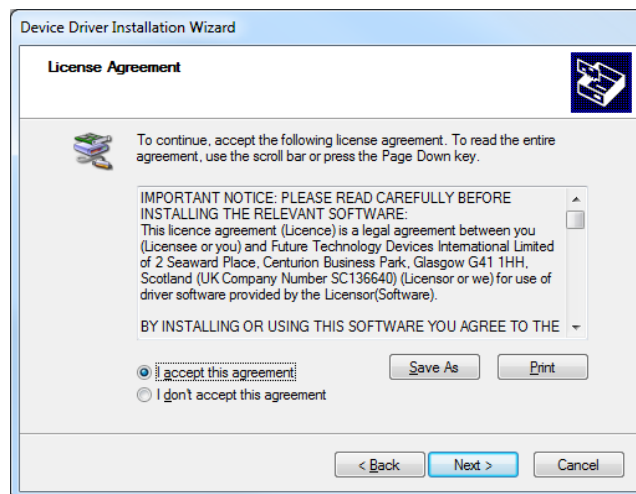

Figure 14 Install Wizard – license agreement

- h. The wizard will then show the drivers being installed.

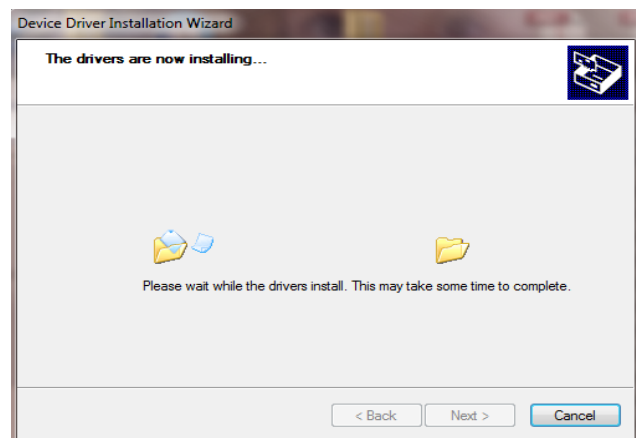

Figure 15 Install Wizard – installing

- i. Finally, the following screen will show that the drivers were installed correctly. Both items have green ticks next to them and have status 'Ready to use'.

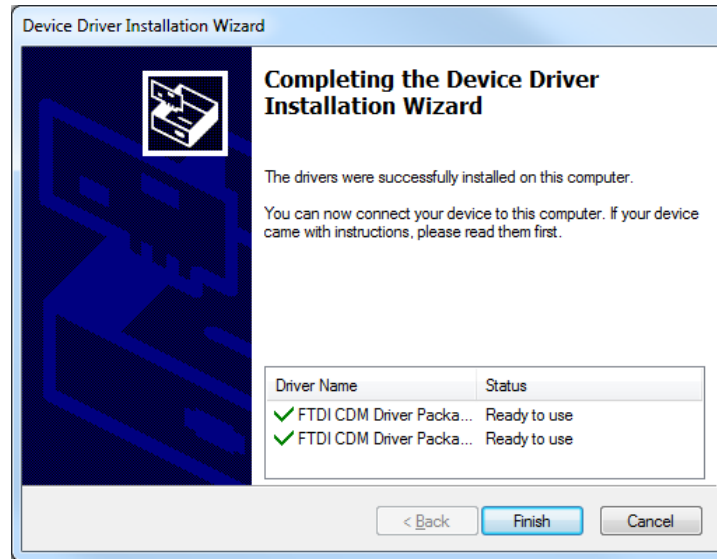

Figure 16 Install Wizard – completion

The driver files are now on your system, and installation of any FTDI products will complete automatically using this latest driver when they are connected.

You can now connect your USB device and wait for Windows to install it as a USB Serial converter and associated USB Serial Port.

You can now proceed to section 4.3 to verify the installation.

Option 2 - Windows Update

If your computer is currently connected to the internet, these steps will help you to install the driver automatically using Windows Update.

If you have already completed the steps in Option 1 above, jump to section 4.3 below as the driver is already installed.

Windows has settings which control whether it will check online for drivers. The actual windows may be subject to change but will be similar to those shown in Figure 17 below. If your computer is not connected to the internet or if you have configured Windows to not allow checking online for drivers, you can use the Driver Executable method above instead (see the start of section 4.2).

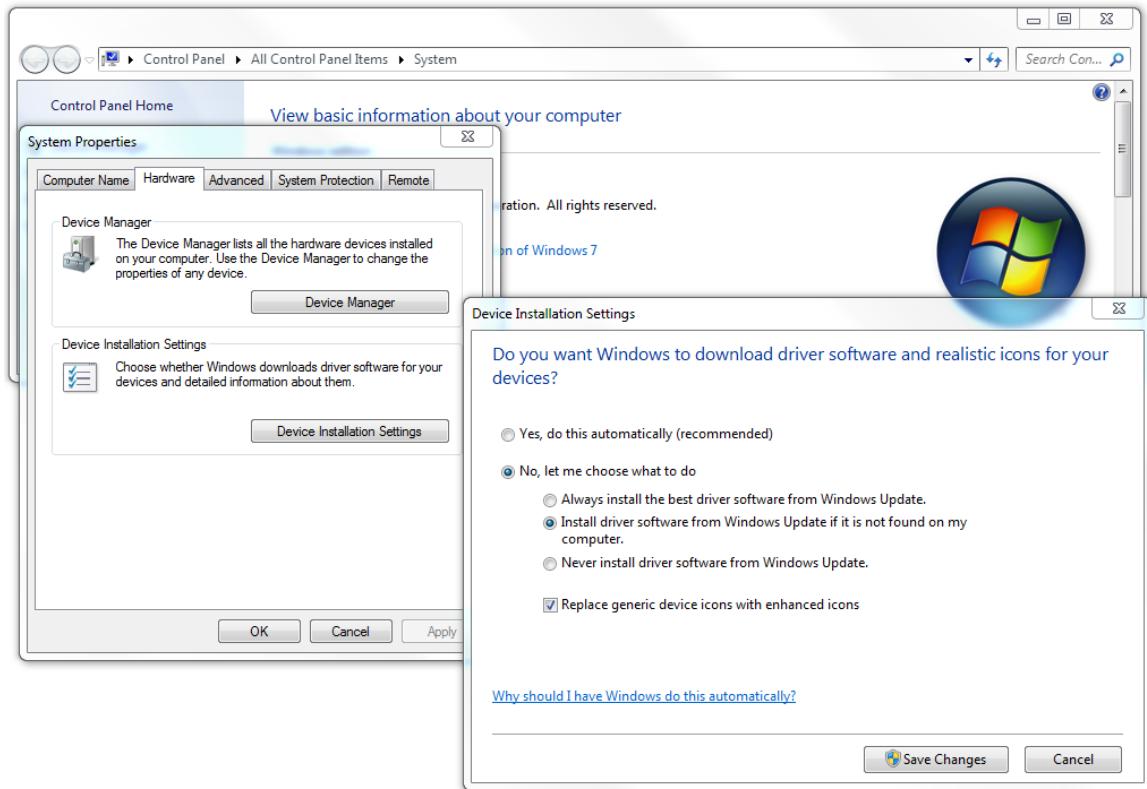

Figure 17 – Windows update settings

- a. Connect the power supply cable to the power inlet socket on the rear panel of the converter, and connect the adapter to a power outlet. (skip this step if your converter is a USB-powered model)
- b. Connect the USB cable to your converter and the other end to an available USB port on your PC.
- c. The computer will recognise the converter and display the Found New Hardware wizard. If this appears, proceed to the next step.

Note that depending on your Windows update and Windows Driver settings, you may not see the New Hardware Wizard. You may instead see a small green animated icon in the task bar which shows that Windows is searching Windows Update in the background. In this case you can click the icon to see the status as shown below. Once it has found the drivers and installed them, you can proceed to step g.



Figure 18 – Windows installing driver in background

- d. Select the option to allow Windows to connect to Windows Update to search for a driver. *Note that you must be connected to the internet to allow this to work. If you are not able to connect to the internet during the install process, use the Driver Executable method. In this case, disconnect the USB cable from the computer and cancel the Found New Hardware wizard before proceeding to step (a) of the Driver Executable section above (see the start of section 4.2).*
- e. Select 'Install the software automatically (recommended)'. Windows will download the driver from Windows Update and install it.
- f. For some converters in the ES-U-xxxx family, Windows will display the Found New Hardware wizard several more times to install all of the serial ports on the converter. Each time the wizard is displayed, repeat steps (c) to (e) above.
- g. Once installation is complete, you will see the following message. Please proceed to section 4.3 below to verify the installation. You do not need to run the steps shown in the Driver Executable section in Option 1 above.

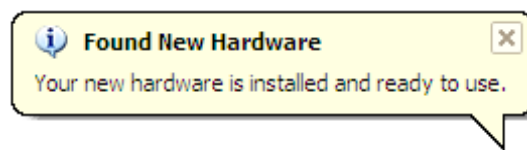

Figure 19 - Hardware installed successfully

4.3

Verifying the Installatio n

Once Windows indicates that the device is installed, you should see the USB Serial Converter in Device manager. An example is shown in Figure 20. Note that for some products, the description may have been customized and so the text descriptions may not match the ones circled below exactly.

The device will show under the Universal Serial Bus Controllers section. In most cases, it will also show under Ports (COM & LPT). This depends on whether the Virtual Com Port (VCP) mode is enabled.

Some application software requires you to enter the COM port number assigned to your serial adapter. This can be found under the Ports (COM & LPT section). In the example in Figure 20, the 4-port converter has COM ports 4 – 7 assigned.

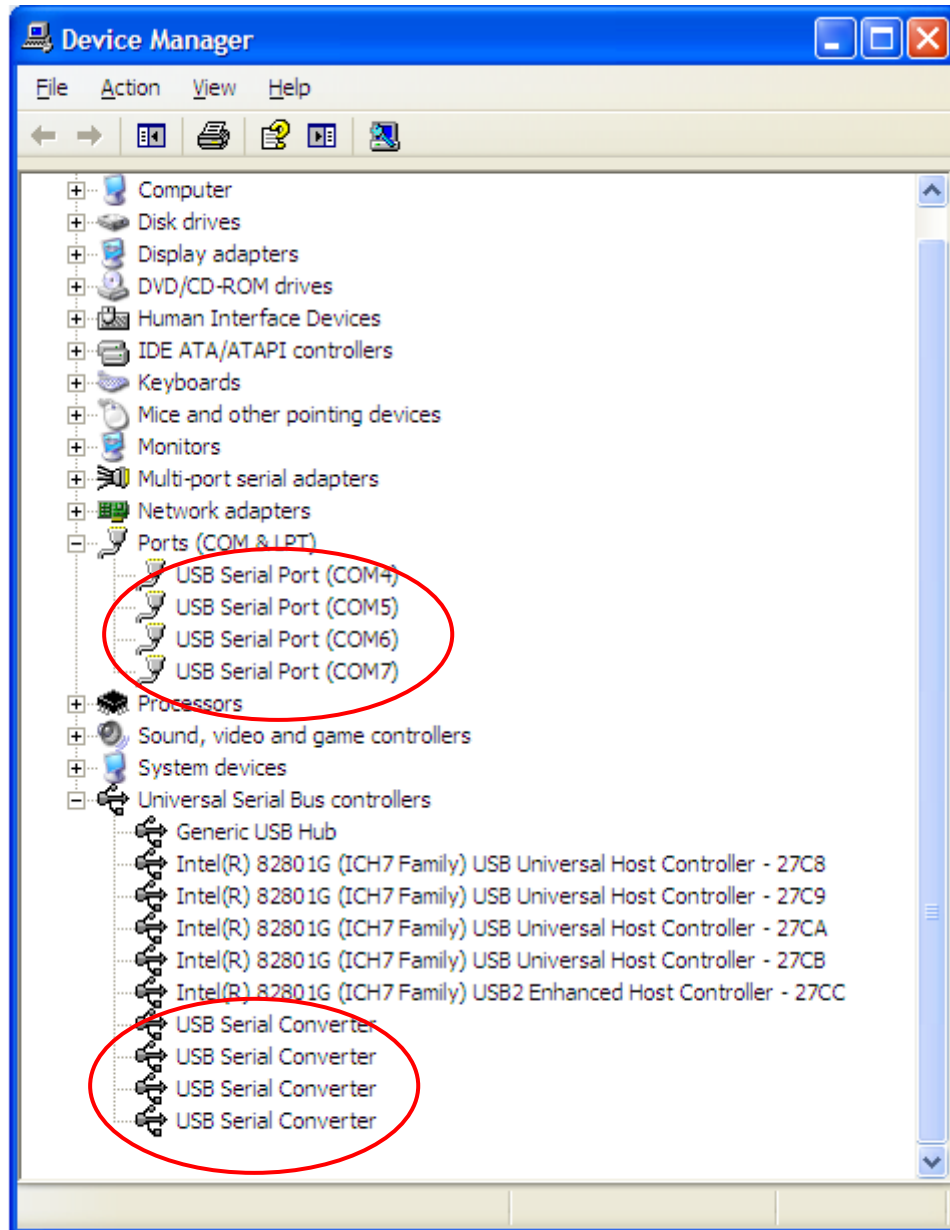

Figure 20 - Device Manager after installing a converter with four ports

4.4

Changing COM Port Properties and COM Number

This feature is particularly useful for programs which only work with COM1 through COM4. Please note that you cannot change to a COM port number which is already in use.

To change the virtual COM port properties:

1. Double-click the "USB Serial Port "in the Device Manager.
2. Select "Port Setting" and "Advanced".
3. Click the drop down arrow on COM Port Number, scroll to the required COM port and Select "OK".
4. Return to the Device Manager Screen. You will see that the USB Serial Port installation has been changed to the new COM Port Number.

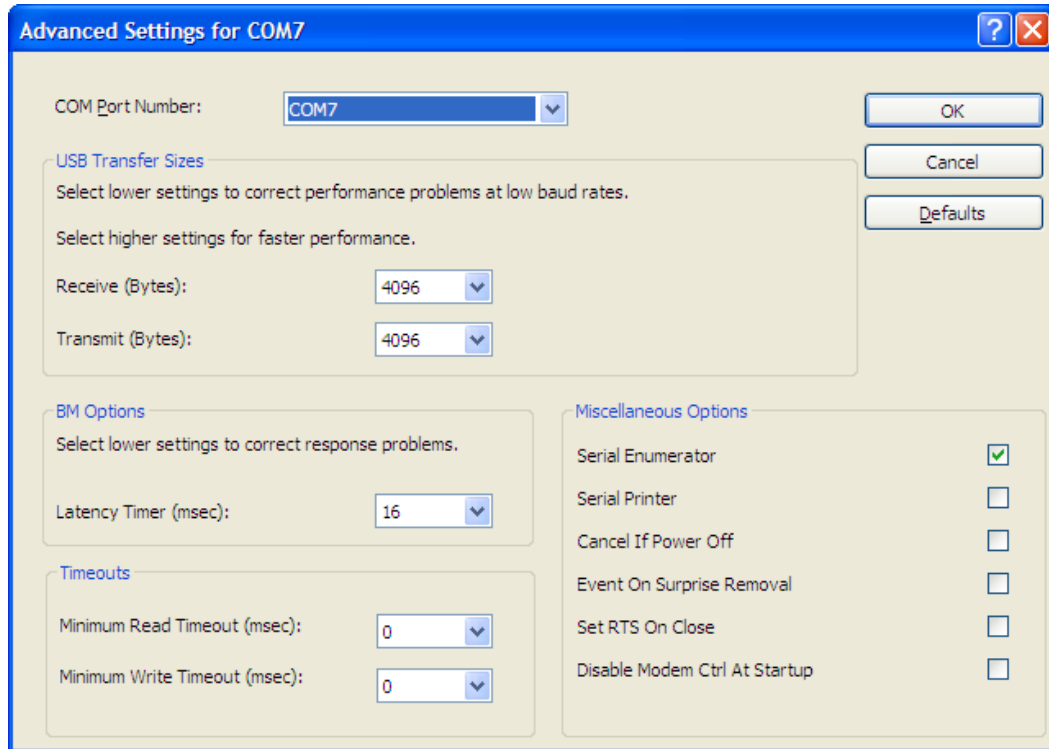

Figure 21 - Advanced port settings dialog

4.5

OS Support - Linux, Mac and Older Windows Versions

This section summarises the OS virtual COM support for the ES-U-xxxx-xx converters. This includes the current version of the OS as well as some older versions of the OS which are discontinued by the OS provider. Please note that whilst guidance is given here, compatibility with legacy OS versions is not guaranteed and any support is at the discretion of Connective Peripherals.

For installation on Windows Vista/XP, Mac OS X, Linux or Windows CE, please refer to the FTDI device drivers and installation guides for your operating system which are available at the following links.

- Installation Guides <http://www.ftdichip.com/Support/Documents/InstallGuides.htm>
- Drivers <http://www.ftdichip.com/Drivers/VCP.htm>

Windows

FTDI provide Windows drivers as an installer executable or via Windows Update

- For current versions (Windows 7 up to Windows 10) use the latest FTDI drivers for both models. Installation can be carried out as shown in section 4.2 by either manual installer or Windows Update.
- For legacy Windows XP/Vista, use driver 2.08.24. This is available from the *No Longer Supported* drivers table at FTDI VCP Drivers

Linux

Many distributions include a sio driver for FTDI chipsets.

- Distributions containing the ftdi_sio and using Kernel 3.0.27 onwards support ES-U-xxxx-xx in the sio driver
- For legacy distributions which include ftdi_sio but have a Kernel older than 3.0.27, the revision B and C versions of ES-U-xxxx-xx may not be supported as the Kernel and sio pre-date the USB-serial chipsets used. Connective Peripherals have a udev rule provided on the Downloads tab of the product page (see the Connective Peripherals website) which adds the Product ID of the FT231X (0x6015) to the sio driver. This allows the updated version of the product to work on some legacy Linux versions.

Mac OS X

OS X versions from Mavericks onwards include an Apple-provided driver for FTDI chipsets.

- For OS X Sierra and OS X High Sierra, the driver included with the OS supports both models
- Some older OS X versions post-Mavericks include an FTDI driver supporting the FT232B and FT232R but not supporting the FT231X chipset which is used in rev B and C of some products. In these cases the FTDI-provided VCP driver can be used with the updated product. These are available from the *Currently Supported Drivers* table at FTDI VCP Drivers page (see link at the top of this page) and can be installed using the procedure explained in the Mac OS X Installation guide (see the Install Guides link at the top of this page)

5 Switch and Jumper Settings

This section applies to ES-U-2xxx-x and ES-U-3xxx-x converters, which can be configured for different interface types. These converters have DIP switches and internal jumpers to select the required interface. The following pages give details of the settings required for each particular model of converter. Ensure that you refer to the correct section for your model of converter. The relevant model numbers are listed at the top of each section. Always read the general notes and warnings on this page before proceeding to configure your device.

5.1

General Notes and Warnings

Safety



For ES-U-xxxx-RM models with internal power supplies, the power cable must be disconnected before removing the cover. Opening the cover will expose connections and boards carrying lethal voltages. Contact with these will cause severe injury or death. In common with all switching power supplies connected to the mains (120/240VAC), the power supply board in these products can remain charged with dangerous voltages for some time after the power input is disconnected and so avoid contact with the power supply board inside the converter even when un-powered.

Serial Bus Configuration

It is important to configure the DIP switches and jumpers to select the correct type of serial bus (RS-232, RS-422 or RS-485) for your application before connecting the ES-U-xxxx-x converter to your serial bus. Otherwise damage can occur to the converter or other equipment on the RS-232/RS-422/RS-485 bus.

To avoid damage, the power supply (or power cable in rack-mount units), serial cables and USB cable should be disconnected from your converter before changing DIP switch settings and before opening the case to change jumper settings.

Termination

For RS-422 or RS-485, it may be necessary to enable termination of the data transmission lines. This depends on the way in which your network is connected and if termination is already provided by other devices on the network. Before applying the termination, check your cable specification for proper impedance matching. Termination is not needed for RS232 and may affect the signals if enabled.

Termination is normally used in the node at each end of the bus, but nodes in the middle of the bus should not have termination enabled. The ES-U-xxxx-x converters have jumpers (or DIP switches) to allow internal termination resistors to be enabled if required. This avoids the need to provide an external resistor at the ES-U-xxxx-x end of the bus.

ES-U-xxxx-x converters have jumpers/switches for both Tx +/- termination and Rx +/- termination. When using RS-485 half-duplex, only the Rx +/- termination should be enabled as indicated by the comments in the jumper / switch setting tables for each product.

Biasing

For RS-485 half-duplex, it may be necessary to enable biasing of the data transmission lines. In some cases, the RS-485 lines may float to undefined levels when no transmitter is active, and this can cause additional unexpected characters to appear at the start or end of a message. Biasing resistors are used to set a defined logic level on the serial lines when no node is transmitting.

Some ES-U-xxxx-x models feature internal 750 ohm resistors with jumpers to enable/disable them. These should be disabled if another device on your serial bus already provides biasing as biasing of data lines must only occur at a single point in the cabling. They are not required in RS-422 or RS-485 full-duplex, since the transmitter is always enabled. Biasing is not required for RS232 and may affect the signals if enabled.

ES-U-xxxx-x converters have four jumpers to select biasing on Tx+, Tx-, Rx+ and Rx-. Section 5 describes these in more detail. For half-duplex RS-485, only the jumpers for Rx biasing (*Pull up of Rx+* and *Pull down of Rx-*) should be fitted. The jumpers for Tx biasing (*Pull up of Tx+* and *Pull down of Tx-*) should not be fitted as this would provide two biasing resistors per line.

5.2 ES-U-2x01B / ES-U-2x01C Adapters (Plastic Enclosure)

This section applies to the following adapters:

- ES-U-2001B (see note below)
- ES-U-2001C (see note below)
- ES-U-2101B (see note below)
- ES-U-2101C (see note below)

Note: This section applies *only* to revision B and C units which have the part numbers listed above. For the original ES-U-2001 and ES-U-2101, please refer to version 1.4 of this guide which is available from the Connective Peripherals website.

This section does not apply to ES-U-2xxx-M (metal case) adapters. Please see sections 5.3 and 5.4 for these products.



See the General Notes and Warnings on page 23 before changing settings or opening the cover. The jumpers should be set to select the correct serial mode before connecting the converter to your RS-422/RS-485 serial bus.

DIP Switch Settings

On the inside of the unit, there are three DIP switches, which are used to select the required serial mode (RS-422 or RS-485).

| | Operation Mode | S1 | S2 | S3 |
|--------|-----------------------------------|-----|-----|-----|
| RS-422 | 4 Wire with handshaking | ON | ON | ON |
| RS-485 | Full Duplex (4 wire) | OFF | ON | ON |
| | Half Duplex (2 wire) with Echo | OFF | OFF | ON |
| | Half Duplex (2 wire) without Echo | OFF | OFF | OFF |

Table 2 - RS-422 & RS-485 Mode Configuration

Jumper Settings

Inside the unit, there is a 7x3 (21 pin) header block. Jumpers are used to select features such as 120 Ohm termination on Tx, Rx and CTS, and 750 Ohm biasing resistors on Tx and Rx. You will need to open up the cover and set the jumpers as per the requirements of your application.

| Jumper | Function |
|---------|---|
| 1 - 2 | Enable Tx+/- Termination with 120 Ohm. This jumper should be populated for RS-485 half-Duplex mode |
| 2 - 3 | Disable Tx+/- Termination |
| 4 - 5 | Pull-up Tx+ to VCC by 750 Ohm Bias resistor. This jumper should be populated to enable pull-up of Tx+ |
| 5 - 6 | Disable Pull-up of Tx+ to VCC |
| 7 - 8 | Pull-down Tx- to GND by 750 Ohm Bias resistor This jumper should be populated to enable pull-down of Tx- |
| 8 - 9 | Disable Pull-down of Tx- to GND |
| 10 - 11 | Enable Rx+/- Termination with 120 Ohm. This jumper should be populated for RS-422 and RS-485 Full-Duplex mode |
| 11 - 12 | Disable Rx+/- Termination |
| 13 - 14 | Pull-up Rx+ to VCC by 750 Ohm Bias resistor. This jumper should be populated to enable pull-up of Rx+ |
| 14 - 15 | Disable Pull-up of Rx+ to VCC |
| 16 - 17 | Pull-down Rx- to GND by 750 Ohm Bias resistor. This jumper should be populated to enable pull-down of Rx- |
| 17 - 18 | Disable Pull-down of Rx- to GND |
| 19 - 20 | Enable CTS Termination with 120 Ohm. This jumper should be populated for RS-422 mode |
| 20 - 21 | Disable CTS Termination |

Table 3 - Jumpers to select Termination and Biasing

Note: If biasing of an RS-485 half-duplex bus is required, enable Rx biasing only (Pull-up Rx+ to VCC by 750 Ohm Bias resistor and Pull-down Rx- to GND by 750 Ohm Bias resistor). Tx biasing should not be used as this would provide two sets of biasing resistors on the bus.

See the notes in section 5.1 before setting Termination and Biasing

5.3

ES-U-2xxx-M and ES-U-2xxx-RM with 3 DIP Switches

This section applies to the following adapters:

- ES-U-2002-M
- ES-U-2102-M
- ES-U-2008-M
- ES-U-2016-RM



See the General Notes and Warnings on page 23 before changing settings or opening the cover. The DIP switches should be set to select the correct serial mode before connecting the converter to your RS-422/RS-485 serial bus.

DIP Switch Settings

On the outside of the unit, there are three DIP switches, which are used to select the required serial mode (RS-422 or RS-485).

| | Operation Mode | S1 | S2 | S3 |
|--------|-----------------------------------|-----|-----|-----|
| RS-422 | 4 Wire with handshaking | ON | ON | ON |
| RS-485 | Full Duplex (4 wire) | OFF | ON | ON |
| | Half Duplex (2 wire) with Echo | OFF | OFF | ON |
| | Half Duplex (2 wire) without Echo | OFF | OFF | OFF |

Table 4 - RS-422 & RS-485 Mode Configuration

Jumper Settings

Inside the unit, there is a 7x2 (14 pin) header block for each serial port. Jumpers are used to select features such as 120 Ohm termination on Tx, Rx and CTS, and 750 Ohm biasing resistors on Tx and Rx. You will need to open up the cover and set the jumpers as per the requirements of your application.

| Jumper | Function |
|--------|---|
| 1 - 2 | Enable Tx+/- Termination with 120 Ohm. This jumper should be populated for RS-485 half-Duplex mode |
| 3 - 4 | Pull-up Tx+ to VCC by 750 Ohm Bias resistor. This jumper should be populated to enable pull-up of Tx+ |
| 5 - 6 | Pull-down Tx- to GND by 750 Ohm Bias resistor This jumper should be populated to enable pull-down of Tx- |
| 7 - 8 | Enable Rx+/- Termination with 120 Ohm. This jumper should be populated for RS-422 and RS-485 Full-Duplex mode |

| | |
|---------|---|
| 9 - 10 | Pull-up Rx+ to VCC by 750 Ohm Bias resistor. This jumper should be populated to enable pull-up of Rx+ |
| 11 - 12 | Pull-down Rx- to GND by 750 Ohm Bias resistor. This jumper should be populated to enable pull-down of Rx- |
| 13 - 14 | Enable CTS Termination with 120 Ohm. This jumper should be populated for RS-422 mode |

Table 5 - Jumpers to select Termination and Biasing

Note: *If biasing of an RS-485 half-duplex bus is required, enable Rx biasing only (Pull-up Rx+ to VCC by 750 Ohm Bias resistor and Pull-down Rx- to GND by 750 Ohm Bias resistor). Tx biasing should not be used as this would provide two sets of biasing resistors on the bus. See the notes in section 5.1 before setting Termination and Biasing*

5.4

ES-U-2xxx-M with 4 DIP Switches

This section applies to the following adapters:

- ES-U-2104-M



See the General Notes and Warnings on page 23 before changing settings or opening the cover. The DIP switches should be set to select the correct serial mode before connecting the converter to your RS-422/RS-485 serial bus.

DIP Switch Settings

On the outside of the unit, there are four DIP switches, which are used to select the required serial mode (RS-422 or RS-485).

| | Operation Mode | S1 | S2 | S3 | S4 |
|--------|-----------------------------------|-----|-----|-----|-----|
| RS-422 | 4 Wire with handshaking | ON | ON | OFF | OFF |
| RS-485 | Full Duplex (4 wire) | ON | OFF | OFF | OFF |
| | Half Duplex (2 wire) with Echo | OFF | OFF | OFF | ON |
| | Half Duplex (2 wire) without Echo | OFF | OFF | ON | ON |

Table 6 - RS-422 & RS-485 Mode Configuration

Switch S4 selects 120R termination of TxD. It is normally enabled for half-duplex RS-485 modes but may not be required if both ends of your network are already terminated.

Jumper Settings

Inside the unit, there is a 6x2 (12 pin) header block for each serial port. Jumpers are used to select features such as 120 Ohm termination on Rx and CTS, and 750 Ohm biasing resistors on Tx and Rx. You will need to open up the cover and set the jumpers as per the requirements of your application.

| Jumper | Function |
|--------|---|
| 1 - 2 | Pull-up Tx+ to VCC by 750 Ohm Bias resistor. This jumper should be populated to enable pull-up of Tx+ |
| 3 - 4 | Pull-down Tx- to GND by 750 Ohm Bias resistor This jumper should be populate to enable pull-down of Tx- |

| | |
|---------|---|
| 5 - 6 | Enable Rx+/- Termination with 120 Ohm. This jumper should be populated for RS-422 and RS-485 Full-Duplex mode |
| 7 - 8 | Pull-up Rx+ to VCC by 750 Ohm Bias resistor. This jumper should be populated to enable pull-up of Rx+ |
| 9 - 10 | Pull-down Rx- to GND by 750 Ohm Bias resistor. This jumper should be populated to enable pull-down of Rx- |
| 11 - 12 | Enable CTS Termination with 120 Ohm. This jumper should be populated for RS-422 mode |

Table 7 - Jumpers to select Termination and Biasing

Note: If biasing of an RS-485 half-duplex bus is required, enable Rx biasing only (Pull-up Rx+ to VCC by 750 Ohm Bias resistor and Pull-down Rx- to GND by 750 Ohm Bias resistor). Tx biasing should not be used as this would provide two sets of biasing resistors on the bus. See the notes in section 5.1 before setting Termination and Biasing

5.5

ES-U-3xxx- x and ES-U- 2101-MB

This section applies to the following adapters:

- ES-U-3001-MB
- ES-U-3008-RM
- ES-U-3016-RM
- ES-U-2101-MB



See the General Notes and Warnings on page 23 before changing settings or opening the cover. The DIP switches should be set to select the correct serial mode before connecting the converter to your RS-232/RS-422/RS-485 serial bus.

DIP Switch Settings

On the outside of the unit, there are four DIP switches, which are used to select the required serial mode (RS-232, RS-422 or RS-485).

| | Operation Mode | S1 | S2 | S3 | S4 |
|--------|-----------------------------------|-----|-----|-----|-----|
| RS-232 | | OFF | ON | ON | ON |
| RS-422 | 4 Wire with handshaking | ON | ON | ON | ON |
| RS-485 | Full Duplex (4 wire) | ON | OFF | ON | ON |
| | Half Duplex (2 wire) with Echo | ON | OFF | OFF | ON |
| | Half Duplex (2 wire) without Echo | ON | OFF | OFF | OFF |

Table 8 - RS-232, RS-422 & RS-485 Mode Configuration

Jumper Settings

Inside the unit, there is a 7x2 (14 pin) header block for each serial port. Jumpers are used to select features such as 120 Ohm termination on Tx, Rx and CTS, and 750 Ohm biasing resistors on Tx and Rx. You will need to open up the cover and set the jumpers as per the requirements of your application.

| Jumper | Function |
|---------|---|
| 1 - 2 | Enable Tx+/- Termination with 120 Ohm. This jumper should be populated for RS-485 half-Duplex mode |
| 3 - 4 | Pull-up Tx+ to VCC by 750 Ohm Bias resistor. This jumper should be populated to enable pull-up of Tx+ |
| 5 - 6 | Pull-down Tx- to GND by 750 Ohm Bias resistor This jumper should be populated to enable pull-down of Tx- |
| 7 - 8 | Enable Rx+/- Termination with 120 Ohm. This jumper should be populated for RS-422 and RS-485 Full-Duplex mode |
| 9 - 10 | Pull-up Rx+ to VCC by 750 Ohm Bias resistor. This jumper should be populated to enable pull-up of Rx+ |
| 11 - 12 | Pull-down Rx- to GND by 750 Ohm Bias resistor. This jumper should be populated to enable pull-down of Rx- |
| 13 - 14 | Enable CTS Termination with 120 Ohm. This jumper should be populated for RS-422 mode. |

Table 9 - Jumpers to select Termination and Biasing

Note: If biasing of an RS-485 half-duplex bus is required, enable Rx biasing only (Pull-up Rx+ to VCC by 750 Ohm Bias resistor and Pull-down Rx- to GND by 750 Ohm Bias resistor). Tx biasing should not be used as this would provide two sets of biasing resistors on the bus. See the notes in section 5.1 before setting Termination and Biasing

5V Power Enable Jumper (ES-U-3001-MB and ES-U-2101-MB)

The ES-U-3001-MB and ES-U-2101-MB can supply 5V (at up to 150mA) through Pin 5 of the terminal block to allow external devices to be powered. To enable the power, you need to open the metal case and set the jumper (JP2) to the position of "ON".

| Jumper | Function |
|--------|---|
| ON | Enable the 5V 150mA output on pin 5 of the Terminal Block to provide power for external devices |
| OFF | Disable the 5V 150mA power (Default) |

Table 10 - Jumper to select 5V output

RS232 Pin-Out (ES-U-2101-MB)

The ES-U-2101-MB has only a subset of the signals on the DB-9 connector to provide TxD, RxD, RTS, CTS and GND. The pinout can be found in Table 12.

6 Connector Pinout Information

This section shows the connector pinouts used on the ES-U-xxxx-x converters.

6.1

RS-232

Signal Pin-out

DB-9 Male connector

The RS232 ports are configured as Data Terminal Equipment (DTE), with a 9-contact D-Sub Pin connector. Pin assignments are according to TIA/EIA-574 which formally defines the assignments for a COM port found on many personal computers.

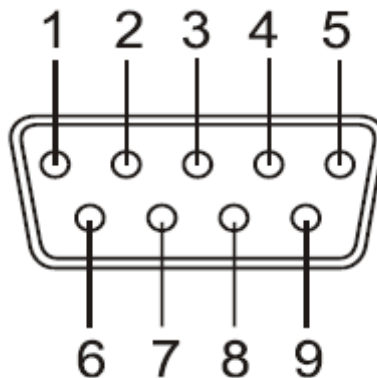

Figure 22 - DB-9 Male Connector Pin Numbers

| Pin Number | Pin Type | Description |
|------------|-------------|---|
| 1 | Input | DCD = Data Carrier Detect |
| 2 | Input | RXD = Receive Data |
| 3 | Output | TXD = Transmit Data |
| 4 | Output | DTR = Data Terminal Ready |
| 5 | Ground | GND = RS232 signal ground |
| 6 | Input | DSR = Data Set Ready |
| 7 | Output | RTS = Request To Send |
| 8 | Input | CTS = Clear To Send |
| 9 | Input | RI = Ring Indicator |
| Shield | Case Ground | Drain = typically connected to the host PC case |

Table 11 - RS-232 Pin-Out for DB-9 connector

RS232 Pin-Out (ES-U-2101-MB)

The ES-U-2101-MB has a reduced set of signals which are shown in the table below. It includes the most commonly used signals TxD/RxD/RTS/CTS/Gnd.

Note that the other pins of the connector must be left unconnected as indicated below.

| Pin Number | Pin Type | Description |
|------------|----------|---------------------------|
| 1 | | Leave un-connected |
| 2 | Input | RXD = Receive Data |
| 3 | Output | TXD = Transmit Data |
| 4 | | Leave un-connected |
| 5 | Ground | GND = RS232 signal ground |
| 6 | | Leave un-connected |
| 7 | Output | RTS = Request To Send |
| 8 | Input | CTS = Clear To Send |
| 9 | | Leave un-connected |

Table 12 - RS-232 Pin-Out for DB-9 connector on ES-U-2101-MB

RJ45 connector

The table below shows the pin-out of the RJ45 connectors used on the ES-U-1032-RM converter.

This converter is also provided with adapter cables which convert the RJ45 into a DB-9 connector. This connector uses the same pin-out as in Table 11 above but the Ring Indicator signal is not available as it is not brought out on the RJ45 connector.

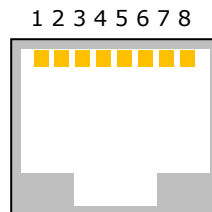

Figure 23 -RJ45 Connector Pin Numbers

| Pin Number | Pin Type | Description |
|------------|----------|---------------------------|
| 1 | Output | RTS = Request To Send |
| 2 | Output | DTR = Data Terminal Ready |
| 3 | Ground | GND = RS232 signal ground |

| | | |
|---|--------|---------------------------|
| 4 | Output | TXD = Transmit Data |
| 5 | Input | RXD = Receive Data |
| 6 | Input | DCD = Data Carrier Detect |
| 7 | Input | DSR = Data Set Ready |
| 8 | Input | CTS = Clear To Send |

Table 13 - RS-232 Pin-Out for RJ45 Connector

6.2

RS-422

Signal Pin-out

DB-9 Male connector

The table below shows the RS-422 pin-out of the DB-9 Male connector

| Pin Number | Pin Type | Description |
|------------|-------------|---|
| 1 | Output | TxD- = Transmit data, negative polarity |
| 2 | Output | TxD+ = Transmit data, positive polarity |
| 3 | Input | RxD+ = Receive data, positive polarity |
| 4 | Input | RxD- = Receive data, negative polarity |
| 5 | Ground | GND = Signal ground |
| 6 | Output | RTS- = Request to send, negative polarity |
| 7 | Output | RTS+ = Request to send, positive polarity |
| 8 | Input | CTS+ = Clear to send , positive polarity |
| 9 | Input | CTS- = Clear to send, negative polarity |
| Shield | Case Ground | Drain = typically connected to the host PC case |

Table 14 - RS-422 Pin-Out for DB-9 Connector

5-way Terminal Block

The table below shows the RS-422 pin-out of the 5 way terminal block (only available on some models).

| Pin Number | Pin Type | Description |
|------------|----------|---|
| 1 | Output | TxD- = Transmit data, negative polarity |
| 2 | Output | TxD+ = Transmit data, positive polarity |
| 3 | Input | RxD+ = Receive data, positive polarity |
| 4 | Input | RxD- = Receive data, negative polarity |
| 5 | Ground | GND = Signal ground |

Table 15 - RS-422 Pin-Out for 5-way Terminal Block

6-way Terminal Block

The table below shows the RS-422 pin-out of the 6 way terminal block (only available on some models).

| Pin Number | Pin Type | Description |
|------------|-----------------|---|
| 1 | Output | TxD- = Transmit data, negative polarity |
| 2 | Output | TxD+ = Transmit data, positive polarity |
| 3 | Input | RxD+ = Receive data, positive polarity |
| 4 | Input | RxD- = Receive data, negative polarity |
| 5 | See Description | For ES-U-2101-M, pin 5 is GND For ES-U-3001-MB, pin 5 is optional 5VDC output For ES-U-2101-MB, pin 5 is optional 5VDC output |
| 6 | Ground | GND = Signal ground |

Table 16 - RS-422 Pin-Out for 6-way Terminal Block

Wiring Diagrams

The following diagram shows an RS-422 full-duplex bus. The ES-U-xxxx-x has a built-in resistor for terminating its RxD +/- input, which can be enabled using a jumper. The Tx +/- lines which are outputs from the ES-U-xxxx-x are terminated at the receiver at the other end of the bus as shown. Twisted pair wires are required for each signal pair.

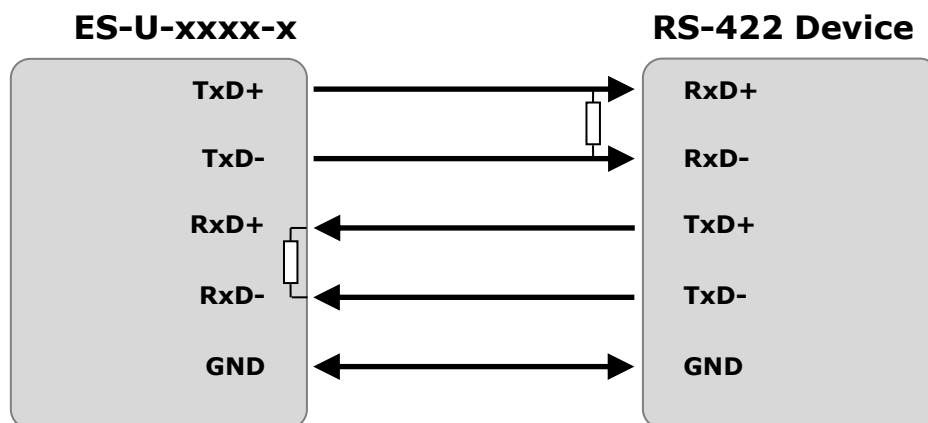

Figure 24 - RS-422 4 Wire Full Duplex

The following diagram shows an RS-422 full-duplex bus with handshaking signals connected. The ES-U-xxxx-x has built-in resistors for terminating its RxD +/- and CTS +/- inputs, which can be enabled using jumpers. The TxD +/- and RTS +/- lines which are outputs from the ES-U-xxxx-x are terminated at the receiver at the other end of the bus as shown. Twisted pair wires are required for each signal pair.

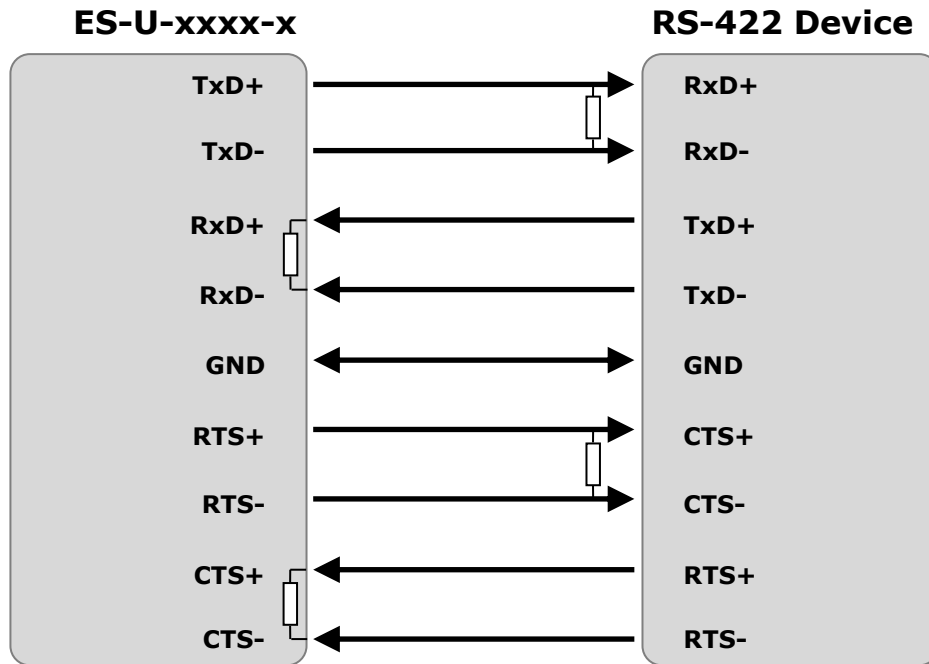

Figure 25 - RS-422 with Handshaking Signals Connected

6.3

RS-485 Signal Pin- out (Half Duplex)

DB-9 Male connector

The table below shows the RS-485 (half duplex) pinout of the DB-9 male connector.

| Pin Number | Pin Type | Description |
|------------|-------------|--|
| 1 | Out / In | Data- = Transmit / Receive Data, negative polarity |
| 2 | Out / In | Data+ = Transmit / Receive Data, positive polarity |
| 5 | Ground | GND = Signal ground |
| Shield | Case Ground | Drain = typically connected to the host PC case |

Table 17 - RS-485 Half-Duplex Pin-out for DB-9 Connector

Note: Other pins have no function in this mode and should be left un-connected.

5-way Terminal Block

The table below shows the RS-485 (half duplex) pinout of the 5 way terminal block (only available on some models).

| Pin Number | Pin Type | Description |
|------------|----------|--|
| 1 | Out / In | Data- = Transmit / Receive Data, negative polarity |
| 2 | Out / In | Data+ = Transmit / Receive Data, positive polarity |
| 5 | Ground | GND = Signal ground |

Table 18 - RS-485 Half-Duplex Pin-Out for 5-way Terminal Block

Note: Other terminals have no function in this mode and should be left un-connected.

6-way Terminal Block

The table below shows the RS-485 (half duplex) pinout of the 6 way terminal block (only available on some models).

| Pin Number | Pin Type | Description |
|------------|----------|--|
| 1 | Out / In | Data- = Transmit / Receive Data, negative polarity |

| | | |
|---|-----------------|---|
| 2 | Out / In | Data+ = Transmit / Receive Data, positive polarity |
| 5 | See Description | For ES-U-2101-M, pin 5 is GND For ES-U-3001-MB, pin 5 is optional 5VDC output For ES-U-2101-MB, pin 5 is optional 5VDC output |
| 6 | Ground | GND = Signal ground |

Table 19 - RS-485 Half-Duplex Pin-out for 6-way Terminal Block

Note: Other terminals have no function in this mode and should be left un-connected.

Wiring Diagrams

The diagram shows an ES-U-xxxx-x converter connected to an RS-485 half-duplex bus. If the ES-U-xxxx-x is at one end of the bus (as shown), the built-in resistor can be enabled to terminate the Data +/- lines. The Tx +/- termination jumper or DIP switch is used to enable this resistor. A second termination resistor is fitted at the other end of the bus as shown.

If additional unexpected zero bytes are being received, some models of ES-U-xxxx-x converter also features bias resistors (not shown below) which can be enabled by fitting the *Pull up Tx+ to VCC* and *Pull down Tx- to GND* jumpers. These should not be enabled if another device on the bus is already providing biasing. Twisted pair wires are required for each signal pair.

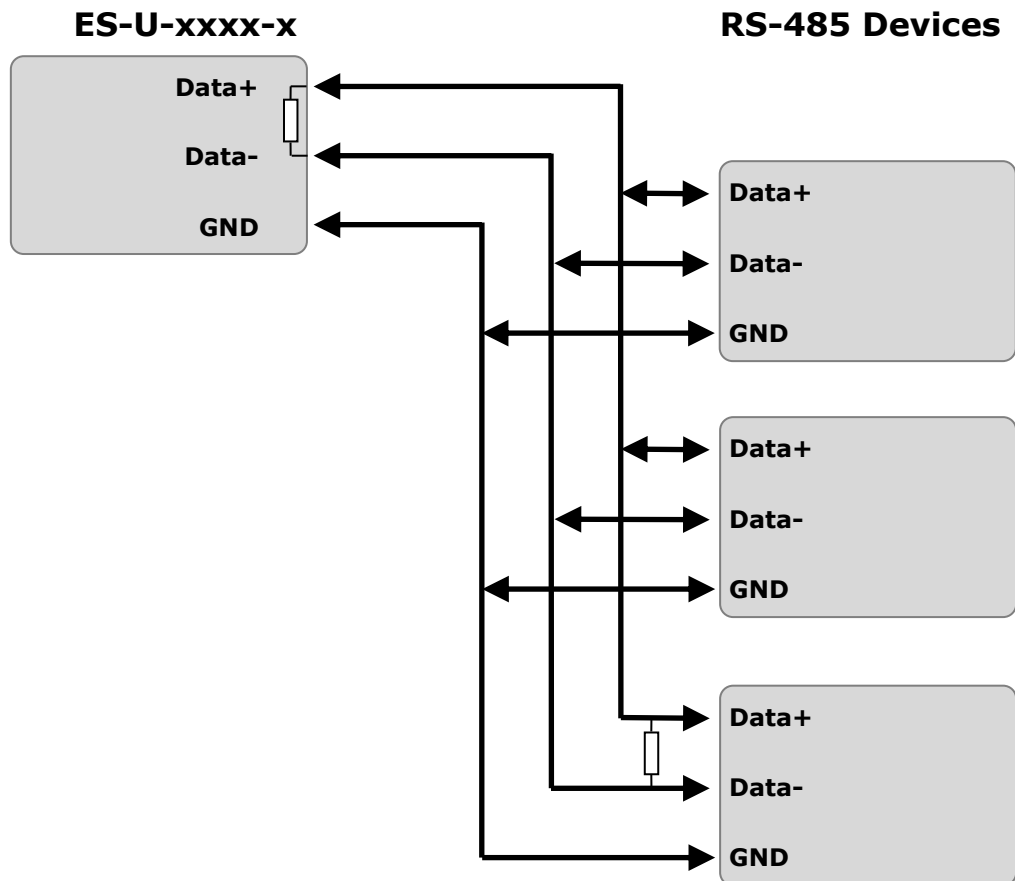

Figure 26 - RS-485 Half Duplex Wiring

6.4

RS-485 Signal Pin- out (Full Duplex)

DB-9 Male connector

The table below shows the RS-485 (full duplex) pinout of the DB-9 male connector.

| Pin Number | Pin Type | Description |
|------------|-------------|---|
| 1 | Output | TxD- = Transmit data, negative polarity |
| 2 | Output | TxD+ = Transmit data, positive polarity |
| 3 | Input | RxD+ = Receive data, positive polarity |
| 4 | Input | RxD- = Receive data, negative polarity |
| 5 | Ground | GND = Signal ground |
| Shield | Case Ground | Drain = typically connected to the host PC case |

Table 20 - RS-485 Full Duplex Pin-out for DB-9 Connector

Note: Other pins have no function in this mode and should be left un-connected.

5-way Terminal Block

The table below shows the RS-485 (full duplex) pinout of the 5 way terminal block (only available on some models).

| Pin Number | Pin Type | Description |
|------------|----------|---|
| 1 | Output | TxD- = Transmit data, negative polarity |
| 2 | Output | TxD+ = Transmit data, positive polarity |
| 3 | Input | RxD+ = Receive data, positive polarity |
| 4 | Input | RxD- = Receive data, negative polarity |

| | | |
|---|--------|---------------------|
| 5 | Ground | GND = Signal ground |
|---|--------|---------------------|

Table 21 - RS-485 Full Duplex Pin-out for Terminal Block

6-way Terminal Block

The table below shows the RS-485 (full duplex) pin-out of the 6 way terminal block (only available on some models).

| Pin Number | Pin Type | Description |
|------------|-----------------|---|
| 1 | Output | TxD- = Transmit data, negative polarity |
| 2 | Output | TxD+ = Transmit data, positive polarity |
| 3 | Input | RxD+ = Receive data, positive polarity |
| 4 | Input | RxD- = Receive data, negative polarity |
| 5 | See Description | For ES-U-2101-M, pin 5 is GND For ES-U-3001-MB, pin 5 is optional 5VDC output For ES-U-2101-MB, pin 5 is optional 5VDC output |
| 6 | Ground | GND = Signal ground |

Table 22 - RS-485 Full Duplex Pin-out for Terminal Block

Wiring Diagrams

The following diagram shows an RS-485 full-duplex bus. The ES-U-xxxx-x has a built-in resistor for terminating its RxD +/- input, which can be enabled using a jumper. The Tx +/- lines which are outputs from the ES-U-xxxx-x would be terminated at the receiver at the other end of the bus as shown. Twisted pair wires are required for each signal pair.

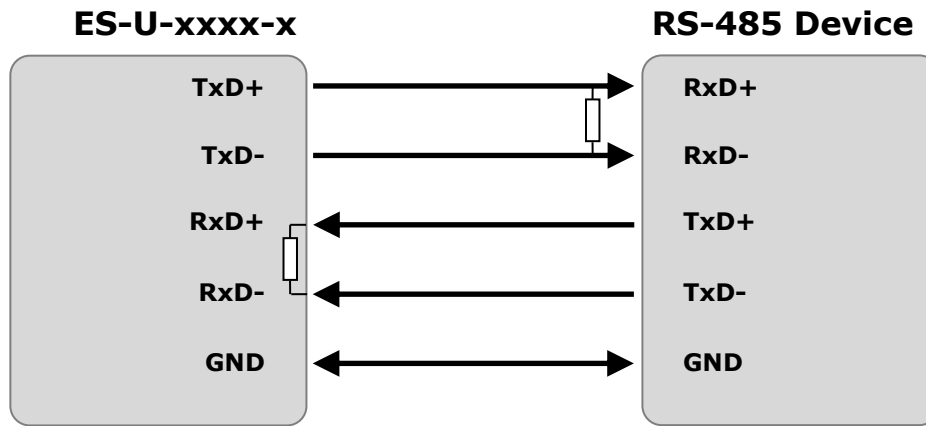

Figure 27 - RS-485 Full Duplex Wiring

6.5 5V Power Output (ES-U-1002-M only)

2-way Terminal Block

The table below shows the pin-out of the 2-way terminal block on the ES-U-1002-M converter. This provides 5V at up to 150mA for external devices. This power is supplied by the USB port of the computer.

| Pin Number | Pin Type | Description |
|------------|----------|--------------------------|
| 1 | Output | 5V output at up to 150mA |
| 2 | Ground | Ground |

Table 23- 5V Power Output

7 Troubleshooting

This section provides some advice to help if you encounter problems during installation or use of your converter. Please check these items before contacting Connective Peripherals technical support. If you still have problems, you can contact technical support using the contact details in section 8 on page 48.

7.1 Hardware

Cables are the most common source of problems with external devices. Please check the following:

USB Connections:

- USB cable is properly connected at both the Computer and the Converter ends
- Use the USB cable provided with the unit
- Computer power is ON and computer is not in Sleep or Standby

USB Hubs:

- If a USB Hub is used, be sure all cables are securely connected
- It is strongly recommended to either connect the USB cable from the converter directly to a port on the PC or via a self-powered hub (which has its own PSU). This is recommended for all converters but may be essential for the converters within the ES-U-xxxx-x series which are powered by the USB port as bus-powered USB hubs can't provide as much power.
- If using a hub which can be either self- or bus-powered, use in self-powered mode and try powering up the hub's power supply before connecting it to the PC's USB port so that it recognises that it is self-powered.
- Hubs certified by the USB-IF are recommended.

Power Connections:

- Check that the power LED on the converter is on.
- If your converter requires an external power supply, ensure that the power supply is securely connected to both the power input socket on the converter and the AC power outlet.
- If your converter has an internal power supply, ensure that the power cable is securely connected to both the power inlet socket on the rear panel of the converter and the AC power outlet.

RS-232 Connections:

- On converters supporting multiple protocols, check that the DIP switches are set for RS-232 mode.
- Output signals (TXD, RTS, DTR) are connected to the respective inputs (RXD, CTS, DSR) in each direction.
- Signal naming conventions can vary between different manufacturers. This manual indicates whether each signal is an input or output on the ES-U-xxxx-xx device. Check the user guide of your RS232 device for the corresponding table and ensure that outputs from the ES-U-xxxx-xx converter go to inputs on the attached device and vice versa.
- Check for specific handshake requirements of your RS232 peripheral. If handshake signals are not used, ensure the application is set to "No Hardware Handshake", or equivalent. Handshaking is recommended however if supported by the attached serial device.
- Ensure that the converter's baud rate and parity settings match the equipment on the other end of the cable.
- Test the port with a loop-back connector. Connect TXD to RXD, RTS to CTS and DTR to DSR. Use a simple terminal program to check that data is transmitted and received.

RS-485/RS-422 Connections:

- Check that the DIP switches or jumpers are set for the serial correct mode (see section 5 starting on page 23). The DIP switch and jumper settings are slightly different for some models of converter, please ensure that you use the instructions in section 5 which correspond to your model of converter.
- Ensure that you have connected the correct pins/terminals according to the wiring diagrams in section 6 (starting on page 32).
- Signal naming conventions vary between manufacturers. This includes notations A and B for RS485. Connective peripherals therefore indicate Data + and Data - instead. Check the manual for your serial device to determine which terminal is Data + and which is Data -.
- Confirm if the jumper settings, such as termination and biasing, are correct for your particular application. This will depend on the other devices on your RS-422/RS-485 network and how they are connected.
- If your application is receiving additional unexpected zero bytes, the biasing resistors can be enabled to resolve this. Section 5 gives details of how to enable the biasing resistors for each model of converter. Note that some ES-U-xxxx do not have internal biasing resistors and so these would need to be fitted externally.
- Some application programs cannot work with the Echo enabled. This can be resolved by disabling the Echo option using the DIP switches or jumpers (depending on model of converter). Section 5 gives details of how to select RS-485 mode without Echo.

7.2

Removing existing FTDI drivers

This procedure for Windows shows how to remove the currently-installed FTDI drivers thereby helping to ensure a clean install.

If the computer has had any earlier versions of the FTDI driver installed, it is recommended to remove the old one first. Also, in the event of issues installing the driver or issues in opening and using the COM port provided by the unit, it is recommended to remove and re-install the drivers.



This procedure is provided for information only. FTDI / Connective Peripherals accept no responsibility whatsoever for any problems or consequences resulting from its use. Users requiring further information should consult the CDM Uninstaller user guide and the installation guides provided for each OS on the FTDI website.

1. Disconnect the USB cable of your FTDI converter(s) from the PC before running the uninstaller.
2. Create a folder on your desktop called CDMuninstaller. Then download the driver uninstaller from the link below and save it into the folder you created.

http://www.ftdichip.com/Support/Utilities/CDMUninstaller_v1.4.zip

Note: If you wish to run this uninstaller tool on a computer which is never connected to the internet, you can download the file using another computer and use a USB flash drive or similar to copy the file over to the computer which will be used with the converter.

3. Unzip the CDMUninstaller program.

- Right-click on the file CDMuninstallerGUI.exe and select 'Run as Administrator' to ensure that the program is run with administrator privileges. You should see the window shown in Figure 28 below.

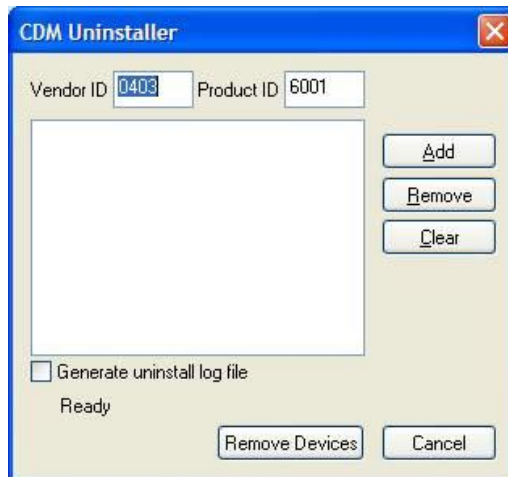

Figure 28 – CDM Uninstaller – Initial window

- Leave the Vendor ID as 0403 and delete the entry 6001 in the Product ID box to leave it blank as shown in Figure 29.

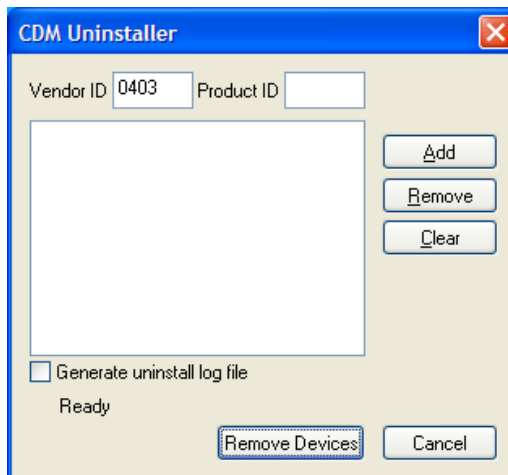

Figure 29 – Changing Product ID window

- Then click the 'Add' button and the window will look like Figure 30 below.

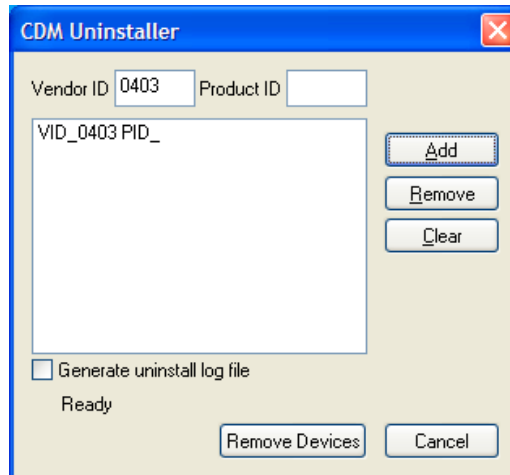

Figure 30 - CDM Uninstaller – Adding to list

7. Finally, click 'Remove Devices' at the bottom of the Window and the drivers for all FTDI converters will be removed. You will get one or more message boxes popping up (see Figure 31) to confirm this.



Figure 31 - CDM Uninstaller – Device removed

8. Once the drivers have all been uninstalled (the large text box will be blank again like Figure 28 above and the status message will be back to 'ready') you can close the program.
9. It is recommended to re-start the PC at this stage.
10. You can now proceed to install the latest driver using the instructions in section 4

7.3

Device Driver Options

Some common Windows Device Driver issues can be resolved by changing the advanced driver options.

- Device Times Out

The default settings of the device driver assume typical data transfers of hundreds to thousands or more bytes at a given time. Some applications, such as a GPS device, only send data in short packets, often only a few bytes. If this is the case, it may be necessary to adjust the driver buffer size and/or latency timer to smaller values. These values can be adjusted through the Advanced Driver Options as noted in Figure 21 on page 20. The buffer size can be reduced to 64 bytes. The latency timer can be set as low as 2ms. A setting of 1ms will cause unnecessary USB traffic and could adversely affect data transmission.

- Erratic mouse pointer (or my adapter appears as a mouse)

The device driver defaults to query an attached device to find out whether it is a mouse or modem, consistent with native COM port operation. Some RS232 peripherals constantly send short packets of data, causing the host system to “think” a mouse or modem has been attached. These short packets will interfere with normal mouse operation causing the pointer to jump around the screen. If this happens, disconnect the RS232 device and uncheck the Serial Enumerator option, also found on the advanced driver options screen (see Figure 21 on page 20).

- COM port number in use

Windows keeps track of all COM port assignments. If multiple products have been connected to a single system, the COM port number will increase, even if the other devices are not attached. If the higher COM port assignments are not acceptable for the application, known unused COM port numbers should be uninstalled according to the FTDI installation guide: <http://www.ftdichip.com/Documents/InstallGuides.htm>.

7.4 Further Information on Resolving Driver Issues

The following resources may be helpful:

- Look at the Installation guide for your operating system at the link below
<http://www.ftdichip.com/Support/Documents/InstallGuides.htm>
- Look at the troubleshooting app note
http://www.ftdichip.com/Support/Documents/TechnicalNotes/TN_104_Guide%20to%20Debugging_Customers_Failed_Driver_%20Installation_%20on_%20Windows.pdf
- If other devices with FTDI chips are installed in the system, check with all manufacturers of these devices for the latest device drivers.

If you have tried the steps shown in section 7 and are still having problems with your ES-U-xxxx-x converter, you can contact Connective Peripherals support using the contact information on the following page.

8 Contact Information

Global Headquarters – Singapore

Connective Peripherals Pte Ltd
178 Paya Lebar Road
#07-03
Singapore 409030

Tel: +65 67430980
Fax: +65 68416071

| | |
|------------------|--|
| E-Mail (Sales) | sales@connectiveperipherals.com |
| E-Mail (Support) | support@connectiveperipherals.com |
| Web Site URL | http://www.connectiveperipherals.com |
| Web Shop URL | http://www.connectiveperipherals.com |

Appendix A - List of Figures and Tables

List of Figures

| | |
|---|----|
| Figure 1 - DB-9 Male serial connectors. Some models also feature terminal blocks..... | 7 |
| Figure 2 - ES-U-1032-RM (RJ45 connectors) is supplied with RJ45-to-DB-9 cables..... | 8 |
| Figure 3 - Example of the Metal Rack-mount enclosure..... | 8 |
| Figure 4 - Examples of the Plastic and Metal (wall mountable) enclosures..... | 8 |
| Figure 5 - Some models use a power adapter with barrel or terminal connector..... | 9 |
| Figure 6 - Rack-mount models have an internal supply with AC input connector..... | 10 |
| Figure 7 - ES-U-2xxx and ES-U-3xxx have DIP switches to select the serial mode..... | 10 |
| Figure 8 - ES-U-3008-RM has a set of jumpers for each port (one set circled)..... | 11 |
| Figure 9 Driver download from FTDI website..... | 13 |
| Figure 10 User account control..... | 13 |
| Figure 11 Install Wizard initial window..... | 14 |
| Figure 12 Install Wizard – extracting files..... | 14 |
| Figure 13 Install Wizard – ready to install..... | 14 |
| Figure 14 Install Wizard – license agreement..... | 15 |
| Figure 15 Install Wizard – installing..... | 15 |
| Figure 16 Install Wizard – completion..... | 16 |
| Figure 17 – Windows update settings..... | 17 |
| Figure 18 – Windows installing driver in background..... | 18 |
| Figure 19 - Hardware installed successfully..... | 18 |
| Figure 20 - Device Manager after installing a converter with four ports..... | 19 |
| Figure 21 - Advanced port settings dialog..... | 20 |
| Figure 22 - DB-9 Male Connector Pin Numbers..... | 32 |
| Figure 23 -RJ45 Connector Pin Numbers..... | 33 |
| Figure 24 - RS-422 4 Wire Full Duplex..... | 36 |
| Figure 25 - RS-422 with Handshaking Signals Connected..... | 37 |
| Figure 26 - RS-485 Half Duplex Wiring..... | 39 |
| Figure 27 - RS-485 Full Duplex Wiring..... | 42 |
| Figure 28 – CDM Uninstaller – Initial window..... | 45 |
| Figure 29 – Changing Product ID window..... | 45 |
| Figure 30 - CDM Uninstaller – Adding to list..... | 46 |
| Figure 31 - CDM Uninstaller – Device removed..... | 46 |

List of Tables

| | |
|---|----|
| Table 1 - Features of the ES-U-xxxx-x converters..... | 6 |
| Table 2 - RS-422 & RS-485 Mode Configuration..... | 24 |

| | |
|--|----|
| Table 3 - Jumpers to select Termination and Biasing | 25 |
| Table 4 - RS-422 & RS-485 Mode Configuration..... | 26 |
| Table 5 - Jumpers to select Termination and <i>Biasing</i> | 27 |
| Table 6 - RS-422 & RS-485 Mode Configuration..... | 28 |
| Table 7 - Jumpers to select Termination and Biasing | 29 |
| Table 8 - RS-232, RS-422 & RS-485 Mode Configuration | 29 |
| Table 9 - Jumpers to select Termination and Biasing | 30 |
| Table 10 - Jumper to select 5V output..... | 30 |
| Table 11 - RS-232 Pin-Out for DB-9 connector | 32 |
| Table 12 - RS-232 Pin-Out for DB-9 connector on ES-U-2101-MB | 33 |
| Table 13 - RS-232 Pin-Out for RJ45 Connector | 34 |
| Table 14 - RS-422 Pin-Out for DB-9 Connector..... | 35 |
| Table 15 - RS-422 Pin-Out for 5-way Terminal Block..... | 35 |
| Table 16 - RS-422 Pin-Out for 6-way Terminal Block..... | 36 |
| Table 17 - RS-485 Half-Duplex Pin-out for DB-9 Connector..... | 38 |
| Table 18 - RS-485 Half-Duplex Pin-Out for 5-way Terminal Block | 38 |
| Table 19 - RS-485 Half-Duplex Pin-out for 6-way Terminal Block..... | 39 |
| Table 20 - RS-485 Full Duplex Pin-out for DB-9 Connector..... | 40 |
| Table 21 - RS-485 Full Duplex Pin-out for Terminal Block | 41 |
| Table 22 - RS-485 Full Duplex Pin-out for Terminal Block | 41 |
| Table 23- 5V Power Output | 42 |

Appendix B - Revision History

| Revision | Changes | Date |
|----------|--|------------|
| 1.0 | Initial release | 2010-12-06 |
| 1.1 | Added operating temperature specification to section 2.1 | 2011-01-26 |
| 1.2 | Added section 5.3 for ES-U-2001B and ES-U-2101C Updated driver screenshots to show latest version (2.08.14) Recommend setting Rx biasing only when using RS-485 half-duplex | 2011-08-23 |
| 1.3 | Re-branding to reflect the migration of the product from EasySync to Connective Peripherals name – logo change, copyright changed, contact information Changed, all internal hyperlinks changed. | 2019-03-20 |
| 1.4 | The following part number have been updated - ES-U-2101B to ES-U-2101C ES-U-3001-M to ES-U-3001-MB ES-U-1101-M to ES-U-1101-MB Updated Figure 10 – Driver Download from FTDI Website | 2019-04-29 |
| | | |

Revision History

Revision history (internal use only, please clearly state all changes here before saving the file)

| Revision | Date YYYY-MM-DD | Changes | Editor |
|----------|--------------------|--|--------------|
| Draft | 2010-09-20 | Initial Draft | Graham Brown |
| Draft | 2010-10-01 | Comments and a few edits throughout | Bob Recny |
| Draft | 2010-10-06 | Reviewed and comments added | Ian Dunn |
| Draft | 2010-11-5 | <p>Updates based on review comments completed</p> <p>Clearer screenshots from new website layout</p> <p>Note that installation instructions/screens show Windows XP and refer to install guides for other versions of Windows/MAC/Linux/CE</p> <p>Changed "mains" to power outlet or AC outlet</p> <p>Corrected wording in some jumper tables</p> <p>Updated wiring diagrams to show termination</p> <p>More detail on how to set jumpers for termination/biasing etc.</p> <p>Added FCC/CE approval section</p> <p>Corrected formatting/font on cover page</p> <p>Corrected formatting of table 1.</p> | Graham Brown |
| Draft | 2010-11-25 | <p>Updated legal disclaimer on front page and added full text of disclaimer after contacts page</p> <p>Updated driver page screenshots</p> <p>Updated RS232 bullet points to show speeds up to 921.6 Kbps depending on model instead of 460Kbps as some units can do up to 921.6Kbps</p> <p>Replaced EasySync with EasySYNC</p> <p>Removed the FCC and CE approvals until we have certificates for each product available</p> <p>Added table on front page showing products covered, and changed title to USB to Serial Converters Manual</p> | Graham Brown |
| draft | 2010-11-26 | Final review | Ian Dunn |
| draft | 2010-12-1 | <p>Updated images of driver page to make clearer</p> <p>Updated Scotland Registered Company Number to SC224924</p> | Graham Brown |
| 1.0 | 2010-12-06 | released as Rev 1.0 | Ian Dunn |
| 1.0 | 2011-13-01 | Added temperature spec to the features section. | Graham Brown |
| 1.0 | 2011-01-14 | Reviewed changes – noticed that the links need updated prior to release. | Bob Recny |

| | | | |
|-----|------------|---|---------------|
| 1.1 | 2011-01-24 | Fixed issue with some links and updated all links in document. Set to revision 1.1 as this is a minor change compared to 1.0. | Graham Brown |
| 1.1 | 2011-01-25 | Added "Twisted pair wires are required for each signal pair." in paragraph above each RS422 and RS485 wiring diagram. Leave at v1.1, updated copyright date | Bob Recny |
| 1.1 | 2011-01-26 | released as Rev 1.1 | Ian Dunn |
| 1.2 | 2011-07-20 | Added section for ES-U-2001-A and ES-U-2101-A. Updated driver screenshots to 2.08.14 Added ES-U-2001-A and ES-U-2101-A to the lists of products throughout the document | Graham Brown |
| 1.2 | 2011-08-11 | Updated part numbers to ES-U-2001B and ES-U-2101C as new units will be known as revision B. | Graham Brown |
| 1.2 | 2011-08-16 | Standardised for all sections that only Rx biasing should be used when an RS-485 half-duplex network required biasing. Previously, some sections recommended Tx only and others recommended Rx only. Either would be OK but updated this to keep it consistent across all models. | Graham Brown |
| | 2011-08-16 | Reviewed | Bob Recny |
| 1.2 | 2011-08-23 | Reviewed and minor mods made. Released as Rev 1.2 | Ian Dunn |
| 1.3 | 2016-12-29 | Re-branding to reflect the migration of the product from EasySync to Connective Peripherals name – logo change, disclaimer changed, copyright changed, contact information changed, all internal hyperlinks changed. | L Subramanian |
| 1.3 | 2019-03-20 | Approved LCE Assigned Clearance number | L Subramanian |
| 1.4 | 2019-04-29 | As advised by Alvin, updated the following part numbers – ES-U-2101B to ES-U-2101C ES-U-3001-M to ES-U-3001-MB ES-U-1101-M to ES-U-1101-MB Updated Figure 10 – Driver Download from FTDI Website | L Subramanian |
| 1.4 | 2019-05-02 | Reviewed – added comments | G Moore |
| 2.0 | 2019-05-02 | Created new version 2.0 for latest range of converters for CP | G Brown |