



SERIES G2 PRODUCT DATA SHEET

MODEL	PART NUMBER	MOTOR TYPE
SG2 18-A-E24V-10DL-WR00-MC	104640	Electric 24V
SG2 18-C-E24V-10DL-WR00-MC	104645	Electric 24V
SERIAL NUMBER	INSPECTED BY	DATE

ENGINEERING DATA		
Rated Pulling Force:	18000 lbf	8165 kgf
Drum Barrel Diameter:	4 in	101.6 mm
Drum Flange Diameter:	8.24 in	209.3 mm
Drum Width:	9.95 in	252.7 mm
Evaluated Rope Diameter:	1/2 in	12.7 mm
Maximum Wire Rope Diameter:	1/2 in	12.7 mm
Minimum Wire Rope Breaking Strength:	26600 lbf	12065 kgf
Maximum Layers of Wire Rope:	3 with 1/2in rope	
Gear Train:	Planetary	
Gear Reduction:	321:1	
Mounting Bolt Size:	M12 X 1.75 Class 8.8	
Mounting Bolt Torque:	46-51 lbf-ft	63-69 Nm
Duty Cycle (per SAE J706 section 6.2):	10.1 ft	3.1 m
Approximate Shipping Weight:	100.5 lbf	45.6
Brake Type:	Automatic Disk Brake per SAE J706 Sec. 4.2	
Sealing:	IP68/IP69K	
UV Rating:	1200 kJ/m ² per ASTM G154	
Corrosion Resistance:	408 hrs per ASTM B117	
Operating Temperature:	-40°F to 158°F (-40°C to 70°C)	
Decibels:	85.5 dB	
EMC Emissions:	CISPR 25:2008	
EMC Immunity:	ISO 7637-2:2004	

PERFORMANCE BY LAYER					
DRUM LAYER	LINE LOAD*			LINE SPEED	
	lbf	kgf	kN	ft/min	m/min
1	18000	8165	80.1	20.3	6.2
2	14727	6680	65.5	23.9	7.3
3	12462	5652	55.4	26.3	8.0

*Never exceed the Rated Pulling Force. Installation of a Rated Capacity Limiter is recommended

FIRST LAYER PERFORMANCE					
LINE LOAD		CURRENT DRAW	LINE SPEED (AT LOAD)		DUTY CYCLE
lbf	kgf	AMPS	ft/min	m/min	min/10min
0	0	45.7	20.3	6.2	2:30
3000	1361	96.9	10.7	3.3	1:30
6000	2722	137.4	7.5	2.3	0:50
9000	4082	177.3	6.3	1.9	0:30
12000	5443	219.6	5.0	1.5	0:15
15000	6804	260.7	3.5	1.1	0:10
18000	8165	290.4	3.9	1.2	0:05



DESCRIPTION

SeriesG2 Electric winches provide new levels of performance, durability, and efficiency to help get jobs done quickly and reliably time after time.

ACCESSORIES

SeriesG2 winches represents an all-new level of modular design, customization, and versatility, no matter the application. Please visit www.warn.com/industrial for all available accessories and options.

STANDARDS COMPLIANCE

2006/42/EC - EN ISO 12100:2010, EN 60529:1992+A2:2013, EN 14492-1:2006*
 2014/30/EU - EN 50498:2010, ISO 7637-2:2011, CISPR 25
 2011/65/EU - EN 63000:2018

Also complies with:
 SAE J706

*Conforms with exceptions

DRUM ROTATION

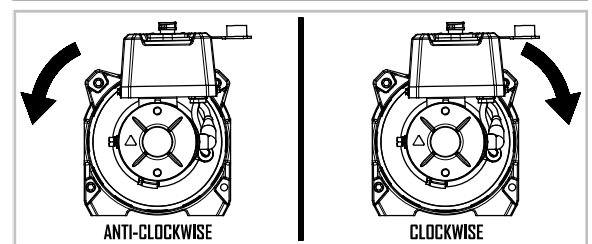

As viewed from motor end

FIRST LAYER PERFORMANCE

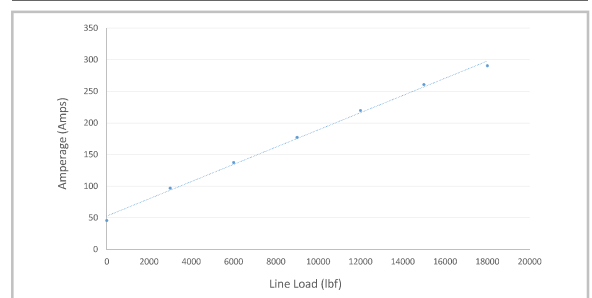



SERIES G2 PRODUCT DATA SHEET

MODEL	PART NUMBER	MOTOR TYPE
-------	-------------	------------

SG2 18-A-E24V-10DL-WR00-MC	104640	Electric 24V
SG2 18-C-E24V-10DL-WR00-MC	104645	Electric 24V

DRUM CAPACITY BY LAYER

DRUM LAYER	DRUM LENGTH							
	6.5"		8"		10"		12.5"	
	ft	m	ft	m	ft	m	ft	m
1	16	4.9	16	4.9	20	6.1	27	8.2
2	36	11.0	36	11.0	45	13.7	61	18.6
3	60	18.3	60	18.3	75	22.9	100	30.5

TOTAL DRUM CAPACITY

ROPE DIAMETER	DRUM LENGTH							
	6.5"		8"		10"		12.5"	
	ft	m	ft	m	ft	m	ft	m
1/2	60	18.3	60	18.3	75	22.9	100	30.5

ELECTRICAL SYSTEM SPECIFICATIONS

Battery Voltage:	24V
Minimum Battery Rating:	650 CCA
Maximum Rated Input Speed:	5531 RPM

WIRING SCHEMATIC

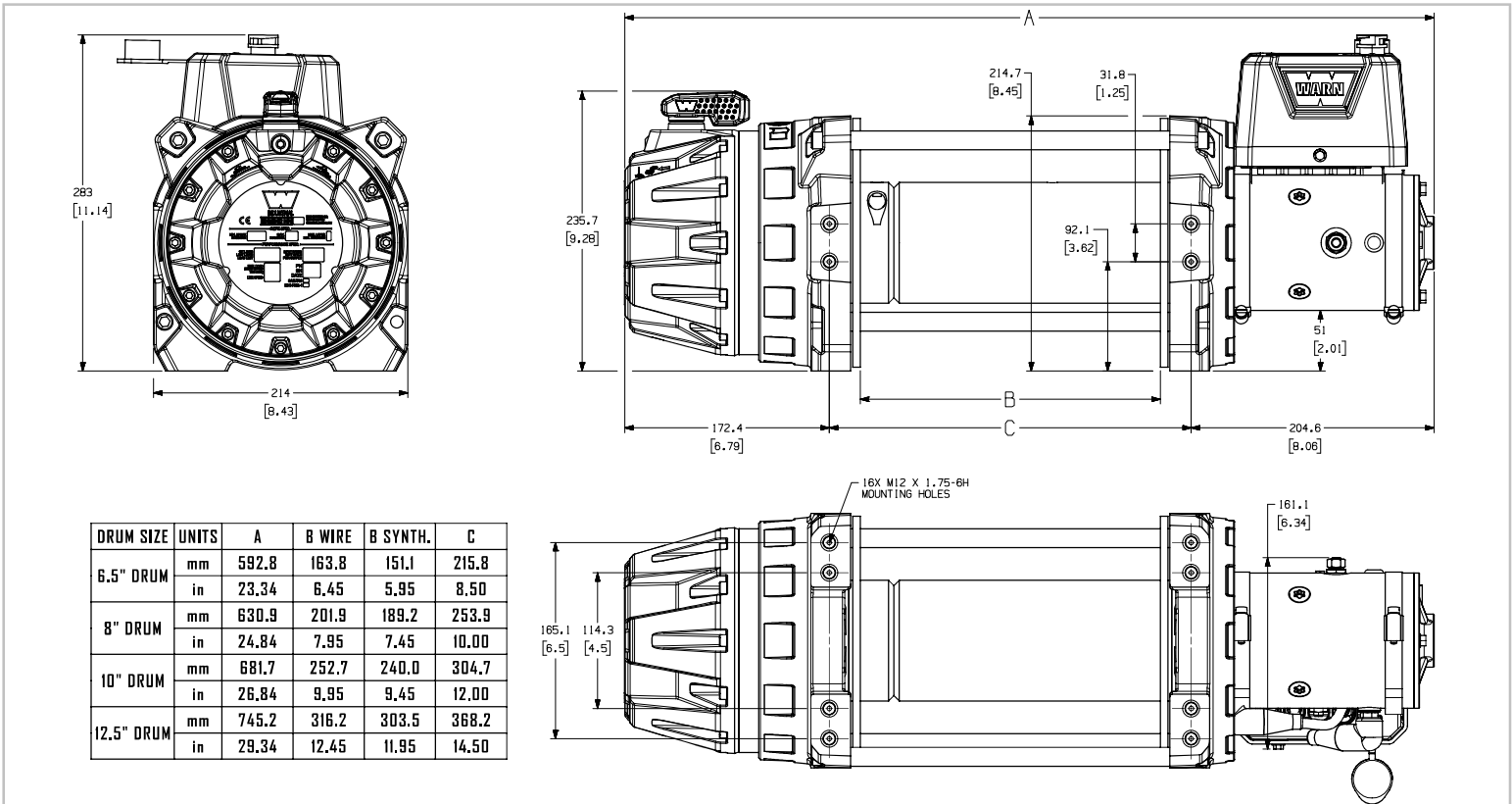
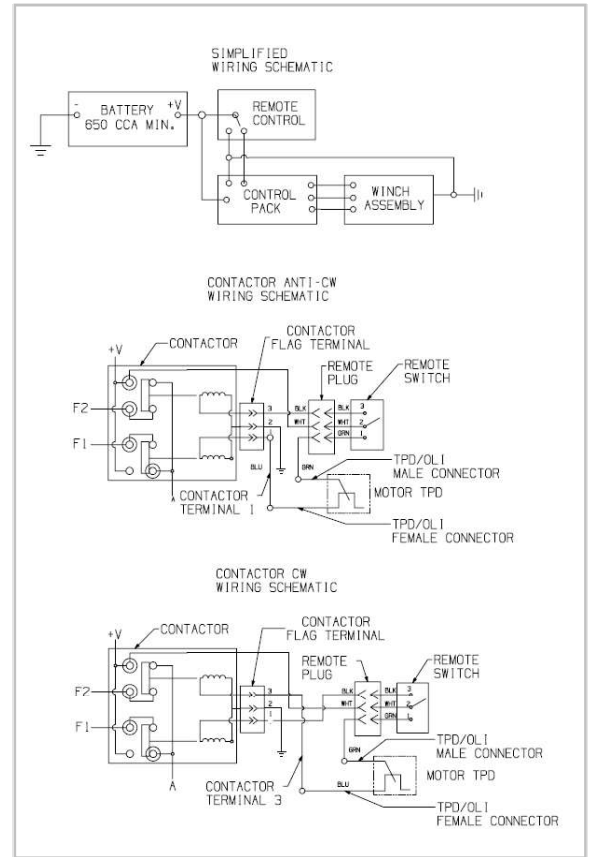

DRUM SIZE	UNITS	A	B WIRE	B SYNTH.	C
6.5" DRUM	mm	592.8	163.8	151.1	215.8
	in	23.34	6.45	5.95	8.50
8" DRUM	mm	630.9	201.9	189.2	253.9
	in	24.84	7.95	7.45	10.00
10" DRUM	mm	681.7	252.7	240.0	304.7
	in	26.84	9.95	9.45	12.00
12.5" DRUM	mm	745.2	316.2	303.5	368.2
	in	29.34	12.45	11.95	14.50



MOUNTING CONFIGURATIONS

MODEL	PART NUMBER	MOTOR TYPE
SG2 18-A-E24V-10DL-WR00-MC	104640	Electric 24V
SG2 18-C-E24V-10DL-WR00-MC	104645	Electric 24V

ALL MOUNTING MUST BE OBSERVED FROM MOTOR END

FEET DOWN, ROPE UNDER DRUM, COMING IN FROM THE LEFT (DUL) - ANTI-CLOCKWISE ROTATION

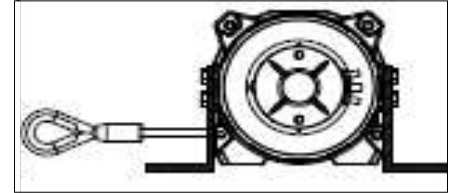
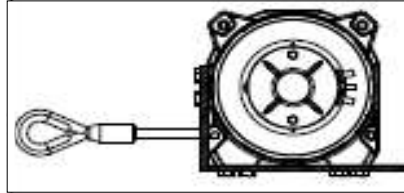
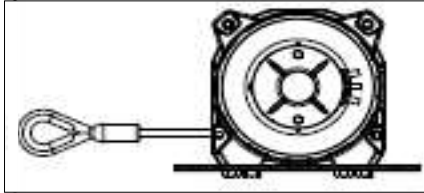

FEET DOWN, ROPE UNDER DRUM, COMING IN FROM THE RIGHT (DUR) - CLOCKWISE ROTATION

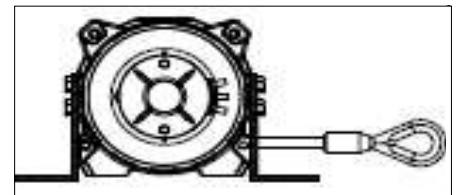
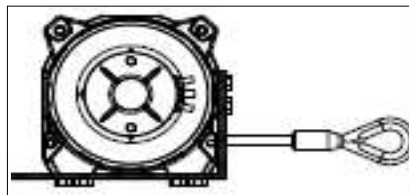
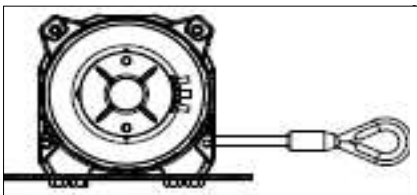

FEET DOWN, ROPE OVER DRUM, COMING IN FROM THE LEFT (DOL) - CLOCKWISE ROTATION

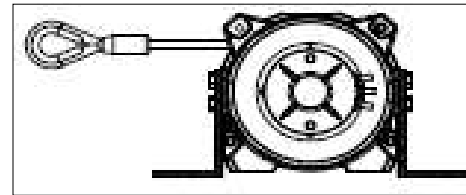
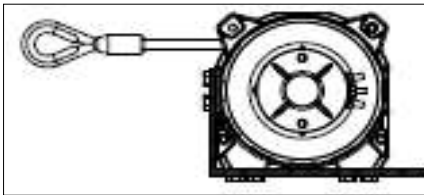

FEET DOWN, ROPE OVER DRUM, COMING IN FROM THE RIGHT (DDR) - ANTI-CLOCKWISE ROTATION

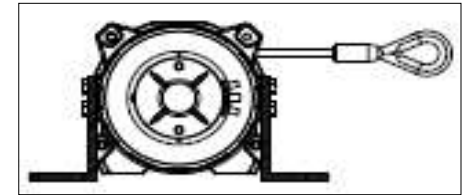
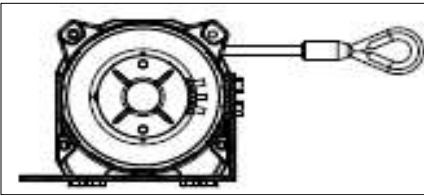

FEET FORWARD, ROPE OVER DRUM, COMING IN FROM THE LEFT (FOL) - CLOCKWISE

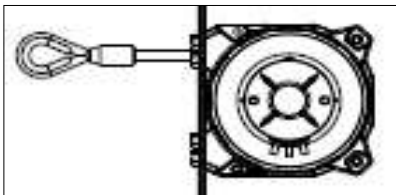

FEET FORWARD, ROPE UNDER DRUM, COMING IN FROM THE LEFT (FUL) - ANTI-CLOCKWISE

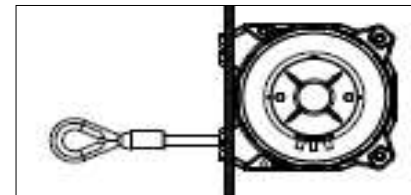

FEET FORWARD, ROPE OVER DRUM, COMING IN FROM THE RIGHT (FOR) - ANTI-CLOCKWISE

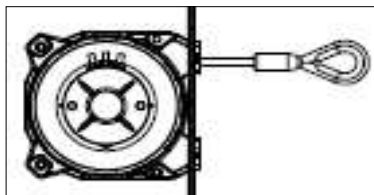

FEET FORWARD, ROPE UNDER DRUM, COMING IN FROM THE RIGHT (FUR) - CLOCKWISE

