



# TRANSLATION OF THE ORIGINAL INSTRUCTIONS

- Keep handy at the place of use -

Wind turbine system  
i-1500, i-2000

SAVE  
ENERGY  
SAVE  
PLANET



# 1 - Contents -

<b>1</b>	<b>Contents .....</b>	<b>2</b>
<b>2</b>	<b>General.....</b>	<b>4</b>
2.1	About this translation of the original instructions .....	4
2.1.1	Revision status of the original instructions .....	4
2.1.2	Conditions for installing and operating the wind turbine system .....	4
2.1.3	Availability of the instructions.....	4
2.2	Conventions used in this translation of the original instructions.....	4
2.2.1	Other symbols used .....	5
2.2.2	Information .....	5
2.3	Name and address of the manufacturer and his authorised representative	5
2.4	Warranty and liability .....	6
2.5	Product feedback .....	6
<b>3</b>	<b>Technical Description.....</b>	<b>6</b>
3.1	Intended use .....	6
3.2	Reasonably foreseeable misuse.....	6
3.3	Main components.....	7
3.4	Main components of the wind turbine .....	8
<b>4</b>	<b>Technical Data.....</b>	<b>9</b>
<b>5</b>	<b>Charge Controller and Specifications.....</b>	<b>10</b>
5.1	Permissible operating and storage conditions.....	12
5.1.1	Storage .....	12
5.1.2	Operation .....	12
<b>6</b>	<b>Safety Information .....</b>	<b>12</b>
6.1	Modifications or changes by the user .....	12
6.2	Residual risks.....	12
6.3	Personnel requirements.....	12
<b>7</b>	<b>Preparing to use the System.....</b>	<b>13</b>
7.1	Shipping .....	13
7.1.1	As-delivered condition .....	13
7.1.2	Scope of supply .....	13

7.2	Requirements at the place of use .....	13
7.2.1	Permissible wind class, footprint and minimum clearances .....	13
7.2.2	Tower foundation .....	14
7.3	Unpacking the components .....	15
7.4	Assembling the wind turbine.....	15
7.5	Electrical connections .....	16
7.6	Erecting the wind turbine .....	17
<b>8</b>	<b>Normal Operation .....</b>	<b>18</b>
8.1	Switching on the wind turbine system.....	18
8.2	Restart after an emergency .....	18
<b>9</b>	<b>Shutting down the Wind Turbine System .....</b>	<b>18</b>
9.1	Emergency shut-down .....	18
9.2	Temporary shut-down.....	18
9.3	Prolonged shut-down.....	18
<b>10</b>	<b>Maintenance .....</b>	<b>19</b>
10.1	Safety precautions during maintenance work.....	19
10.2	Inspection and maintenance schedule .....	19
10.3	Maintenance and cleaning by the user .....	19
<b>11</b>	<b>Troubleshooting and Diagnostics and Suitable Battery Capacities .....</b>	<b>20</b>
11.1	Errors with LED.....	20
11.2	Errors without LED.....	20
<b>12</b>	<b>Removal from Service and Disposal .....</b>	<b>22</b>
12.1	Final decommissioning of the wind turbine system .....	22
12.2	Disposal of the wind turbine system and components .....	22
<b>13</b>	<b>Declaration of Conformity .....</b>	<b>23</b>
<b>14</b>	<b>Index.....</b>	<b>24</b>
<b>15</b>	<b>Notes .....</b>	<b>25</b>
<b>16</b>	<b>Performance Charts.....</b>	<b>26</b>
<b>17</b>	<b>Certificates.....</b>	<b>27</b>

## 2 - General -

### 2.1 About this translation of the original instructions

#### 2.1.1 Revision status of the original instructions

Revision date: ..... 24.07.2018  
 Revision index: ..... 00

#### 2.1.2 Conditions for installing and operating the wind turbine system

Please make sure that

- The wind turbine system has been erected correctly by a suitably trained person.
- All operating personnel have read and fully understood this translation of the original instructions
- The wind turbine system is properly maintained and repaired.

#### 2.1.3 Availability of the instructions

Keep this translation of the original instructions handy at all times, so that it can be referred to by all persons working on or with the wind turbine system.

### 2.2 Conventions used in this translation of the original instructions

Safety information is always identified by a signal word and in some cases also by a hazard-specific symbol.

<b>⚠ DANGER!</b>
<b>Immediate danger!</b> Non-observance of the safety instructions will result in serious or fatal injury!
<b>⚠ WARNING!</b>
<b>Potentially dangerous situation!</b> Non-observance of the safety instructions can result in serious or fatal injury!
<b>⚠ CAUTION!</b>
<b>Potentially dangerous situation!</b> Non-observance of the safety instructions can result in minor or moderate injuries!
<b>IMPORTANT!</b>
<b>Potentially dangerous situation!</b> Non-observance of the safety instructions can result in damage to property or pollution of the environment!

**2.2.1 Other symbols used**

The following symbols are used in this translation of the original instructions as well as on the wind turbine system itself:

**Warning signs**





	General warning!
	Danger: High voltage!
	May start without warning!
	Environmental hazard!

Table 1 Warning signs

**Mandatory signs**



	Read manual before operating!
	Isolate before opening!

Table 2 Mandatory signs

**2.2.2 Information**

	Note Indicates general information and recommendations.
---	--

**2.3 Name and address of the manufacturer and his authorised representative**

Name	ALTINEL ENERJI DIS TIC. ELEK. ELEKTRONIK SAN.VE TIC. LTD. STI
Address	Mermerciler Sanayi Sitesi Merkezi 7 Cadde No:8/2 34524 - Beylikdüzü / Istanbul / TURKEY
Phone	0090-212-8812235
Internet	www.altinelenerji.net

Table 3 Manufacturer

Name	IstaBreeze® Germany GmbH
Address	Riemenstr. 31, DE - 74906 Bad Rappenau
Phone	+49 (0) 7264 - 7024134
Internet	www.istabreeze.com

Table 4 Authorised representative

## 2.4 Warranty and liability

The “General Terms of Sale and Delivery” of the manufacturer or his authorised representative apply.

## 2.5 Product feedback

Please notify the manufacturer or his authorised representative about any of the following

- Accidents
- Potential safety hazards associated with the wind turbine system
- Ambiguities in this translation of the original instructions
- Description of the wind turbine system

# 3 - Technical Description -

## 3.1 Intended use

- The wind turbine system may only be used as a “small wind turbine system” (SWTS) to generate power in accordance with EN 61400-2.
- The wind turbine system may only be operated in accordance with the ratings and in the approved wind class (refer to the technical data).
- Observance of the original instructions and compliance with the maintenance and repair instructions are essential preconditions of use for the intended purpose.

## 3.2 Reasonably foreseeable misuse

All forms of use which deviate from or exceed the limits of use described above are considered to be contrary to the intended purpose. The manufacturer is not liable for any damage resulting from such use.

No liability will be accepted by the manufacturer if the equipment has been altered as well as in the event of improper assembly, installation, start-up, operation, maintenance or repair.

Only original parts supplied by the manufacturer are approved as spare parts or accessories. Any spare parts or accessories not supplied by the manufacturer have not been tested for operation and could be detrimental to reliability. No liability will be accepted by the manufacturer for any damages which result from the use of non-approved spare parts or accessories.

Reasonably foreseeable misuse includes:

- Operation outside the manufacturer’s specification
- All modifications or changes to the wind turbine system without the manufacturer’s written approval!
- Use of parts other than iSTA Breeze original parts.
- Operation in non-approved SWTS classes.
- Operation in strong winds or hurricanes.

### 3.3 Main components

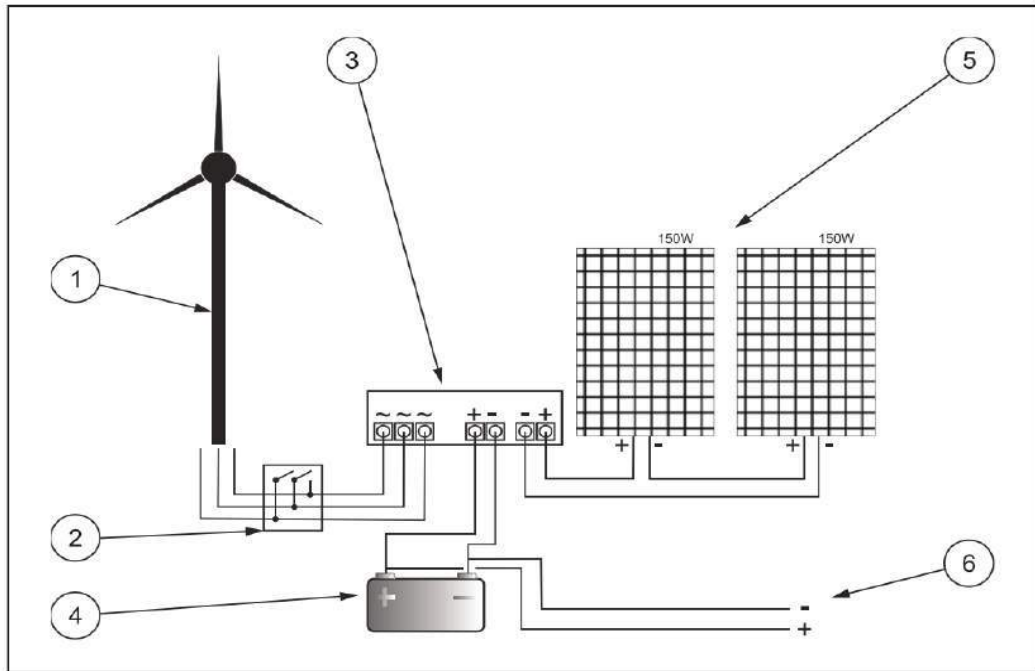

Fig. 1: Main components of the wind turbine system

No.	Component	Function
1	Wind turbine	Converts wind energy into electrical energy
2	Switch switch AC Emergency Stop Button (optional)	Emergency shut-down. When pressed, the wind turbine must be short-circuited.
3	Charge controller (optional) Type : i/HCC 2000	Generates electrical voltage (24 / 48 VDC Optionally). The iSTA Breeze charge controller.
4	Battery (optional)	Stores electrical energy (Acid, Gel)
5	Solar panels (optional)	Convert solar energy into electrical energy
6	To converter (optional)	Converts 24/48 VDC into 110/220 VAC

Table 5 Main components and their functions

	<p>Recommendation: Several batteries can be connected in series or series. Depending on which system voltage is used.</p>
--	---

### 3.4 Main components of the wind turbine

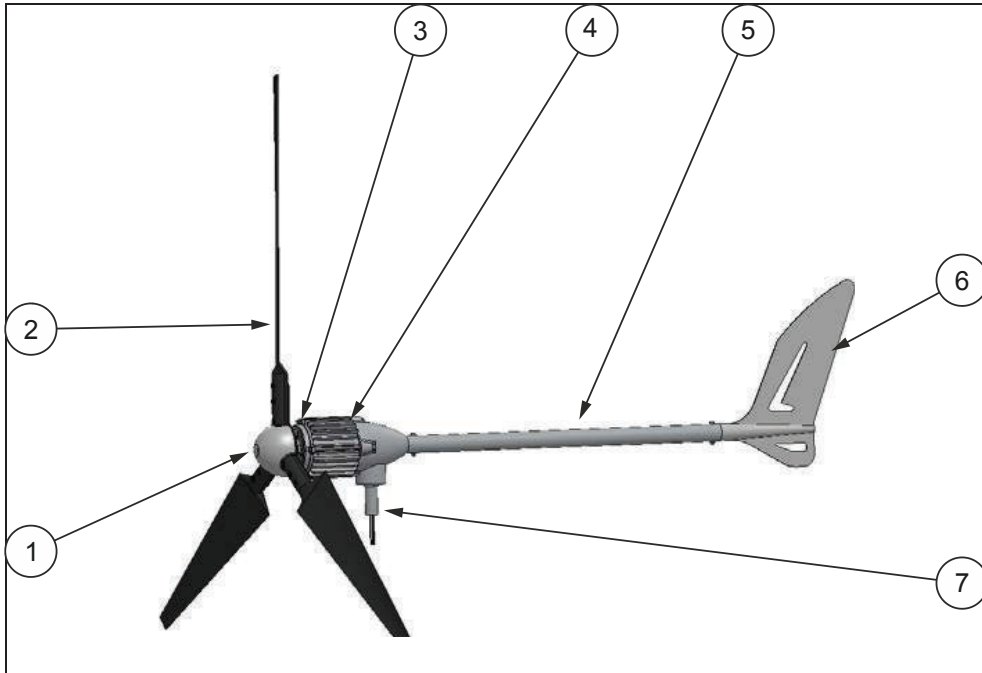

Fig. 2: Main components of the wind turbine

No.	Component	Quantity
1	Nose	1
2	Rotor blade	3
3	Hub for holding the blades	1
4	Generator for producing electricity	1
5	Boom for wind direction flag	1
6	Tail vane for turning the blades into the wind	1
7	Adapter stud $\varnothing$ 37 mm for attaching the wind turbine to the tower	1

Table 6 Main components of the wind turbine and their functions



4

- Technical Data -

Designation	i-1500	i-2000
<b>Generator</b>		
Type	Permanent magnet rotor, brushless, gearless, maintenance-free	
Weight [kg]	25	28
Max. power	24V 55A 48V 25A	48V 40A
Open circuit voltage [VAC]	[24V] 0 - 80 [48V] 0 - 148	[48V] 0 - 143
Current	3-phase-AC	
Start of charging	Approx. 3 m/s (wind speed)	
Housing material	Aluminium	
Direction of rotation	Any	
Test standard	EN 61000-6-1 (electromagnetic compatibility – susceptibility)	
	EN 61000-6-3 (electromagnetic compatibility – emissions)	
<b>Rotor blades</b>		
Hub flange	Cast Steel	
Diameter, approx. [m]	2.10	2.25
Rotor Blades	3 pieces of plastic with glass fiber mixture	
Approx. weight per rotor blade [g]	690	720
Blade Color	Black or White	
Direction of Rotation	from the front in a clockwise direction	
Max. Speed [rpm]	1000	
Noise emissions [dB(A)]	60	

Table 7 Technical data

## 5 - Charge Controller -

The Wind / Solar Hybrid Charge Controller from IstaBreeze<sup>®</sup> is an intelligent controller of the wind turbine and solar cells that controls you at the same time. The high-end device can also be used as a monitoring system. It is used to safely and efficiently charge and control your battery with the Wind Generator / Solar Module combination.

With its discreet appearance, simple operation, with integrated protection functions, this device has high efficiency and low no-load losses. This version of the controller will significantly increase the life and stability of the whole system, especially the batteries.

In addition, the control electronics in the control cabinet monitors the system voltage and brakes the wind turbine when a max. Overvoltage.

The special features and product information are listed below:

Use of external and high quality (Triacs & Hyper Mosfet), solid state components. Increasing the life of the controller.

Microprocessor controlled charge with integrated voltage and current limiting. Electromagnetic brake control. Integrated 3-phase short circuit breakers (brake switch)

Protection against lightning strikes. Protection against overcharging, deep discharge, short circuit, overload and against incorrect reverse polarity.

Integrated display.

The generator is automatically braked gently when the battery is full, modern braking system with external load resistance (Dump Load) to avoid the immediate blocking of the turbine. Increasing the life of the stator.

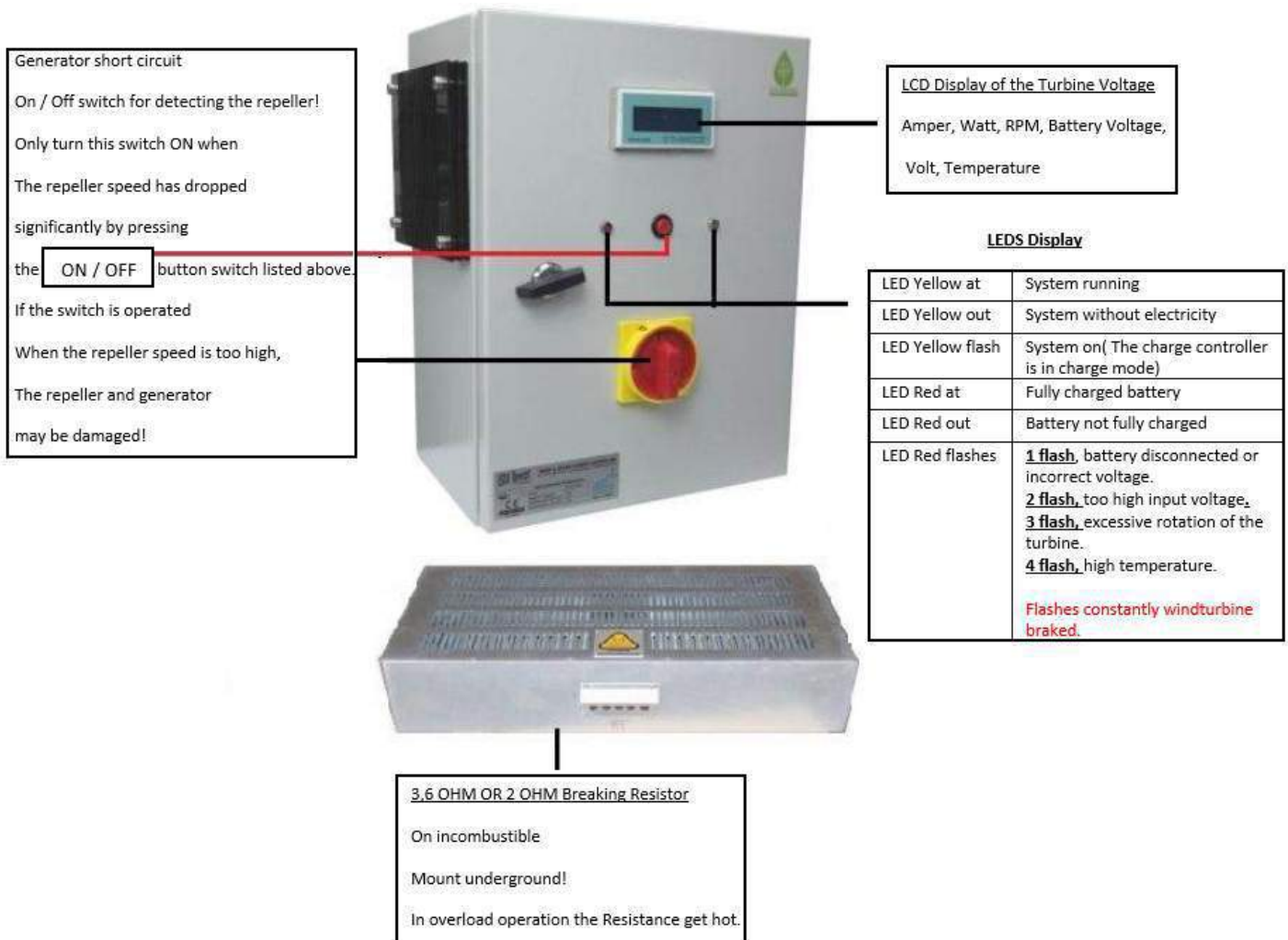

## 5 - Specifications of Charge Controller -

Charge Controller I/HCC-1500/2000		
Nominal battery voltage	48 VDC	24VDC
Maximum input power wind turbine	2,0 KW	1,5 KW
Maximum input power PV module	300 WATT	300 WATT
LCD with 6 displays	Amper, Watt, RPM, Battery Voltage, Volt, Temperature	Amper, Watt, RPM, Battery Voltage, Volt, Temperature
Charging Voltage	52,8V	25,2V
Charging current wind amperes max	33A	55A
Charging current PV Ampere max	10A	10A
Integrated manual stop switch	Maintenance	Maintenance
Battery voltage minimum	42V	17,5V
Brake function( electromagnetic short circuit, Wind Turbine	From 59,4V	From 29,6V
Cooling	External aluminum cooling fins	External aluminum cooling fins
Cable termination	10qmm screw terminals	10qmm screw terminals
Protection class	IP 20 (inside area)	IP 20 (inside area)
Dump Load	2 KW Braking resistor ( 4 Ohms) The load resistance can deviate from the picture	1,5 KW Braking resistor ( 2 Ohms) The load resistance can deviate from the picture
Operating temperature	Normal:20~+55°C/35~85%RH Industrial: 30~+55°C/35~85%RH	Normal:20~+55°C/35~85%RH Industrial: 30~+55°C/35~85%RH
Temperature compensation	-4mV°C/2V, -35 °C-- +80°C, Accuracy +- 1°C	-4mV°C/2V, -35 °C-- +80°C, Accuracy +- 1°C
Size	300x400x200 mm	300x400x200 mm
Weight	6,5 kg	7 kg
Recommended Battery Min.	Acid & Gel	Acid & Gel

**5.1 Permissible operating and storage conditions**

**5.1.1 Storage**

- Ambient temperature: -15 to +40°C
- Storage location: Dry, frost-free

**5.1.2 Operation**

- Ambient temperature: -25 to +40°C
- Place of use: Max. SWTS Class III acc. to EN 61400-2

**6 - Safety Information -**

**6.1 Modifications or changes by the user**

The wind turbine system is in conformity with the European Machinery Directive 2006/42/EC provided only original iSTA Breeze components are used and subject to proper erection. The use of components from other manufacturers as well as modifications or changes to the wind turbine system by the user are prohibited and could render the declaration of conformity invalid!

**6.2 Residual risks**

Any residual risks which arise as a result of operation or maintenance are described in the relevant sections of these instructions.

**6.3 Personnel requirements**

All work on the wind turbine system must be carried out by authorised persons! Such persons must be familiar with the safety devices and regulations prior to carrying out the work.

Authorised persons are defined as follows:

Operating mode	Necessary qualifications
Erection	Suitably trained persons
Normal operation	Trained personnel
Cleaning	Trained personnel
Maintenance	Suitably trained persons
Repair	Manufacturer

Table 8 Personnel requirements

## 7 - Preparing to use the System -

### 7.1 Shipping

#### 7.1.1 As-delivered condition

The wind turbine system is shipped disassembled.

#### 7.1.2 Scope of supply

Refer to the contract documentation for the scope of supply.

### 7.2 Requirements at the place of use

#### 7.2.1 Permissible wind class, footprint and minimum clearances

<b>⚠ WARNING!</b>
<b>Danger to life due to operation in non-approved wind classes!</b>
▶ The wind turbine system may only be operated at Class III wind sites.

For information on local wind classes, please contact the responsible authorities or your nearest meteorological office.

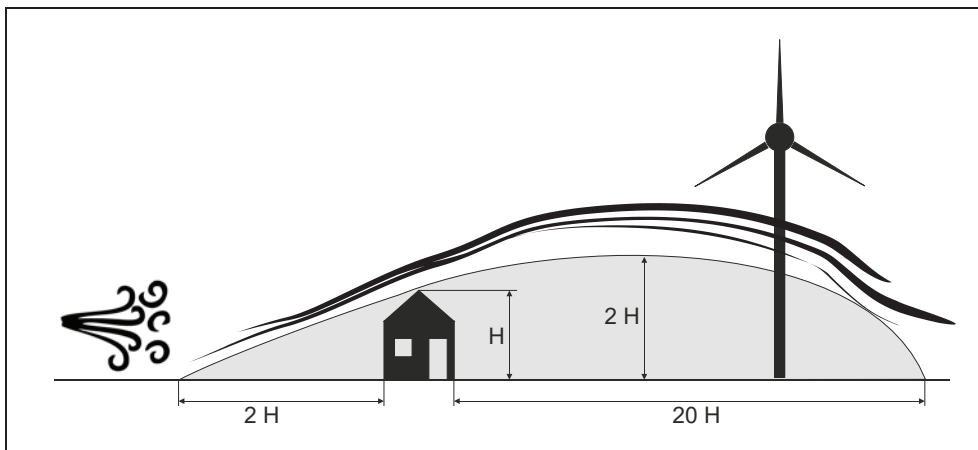

Fig. 3: Footprint and minimum clearances

The place of use must be free of obstacles; alternatively, the wind turbine must be erected with a sufficient height (refer to Fig. 3:). Obstacles are defined as houses, hedges, trees, hills, etc.

<b>☞</b>	When choosing the place of use, make sure adequate room is available to tilt the tower and blades if necessary.
----------	---

7.2.2 Tower foundation

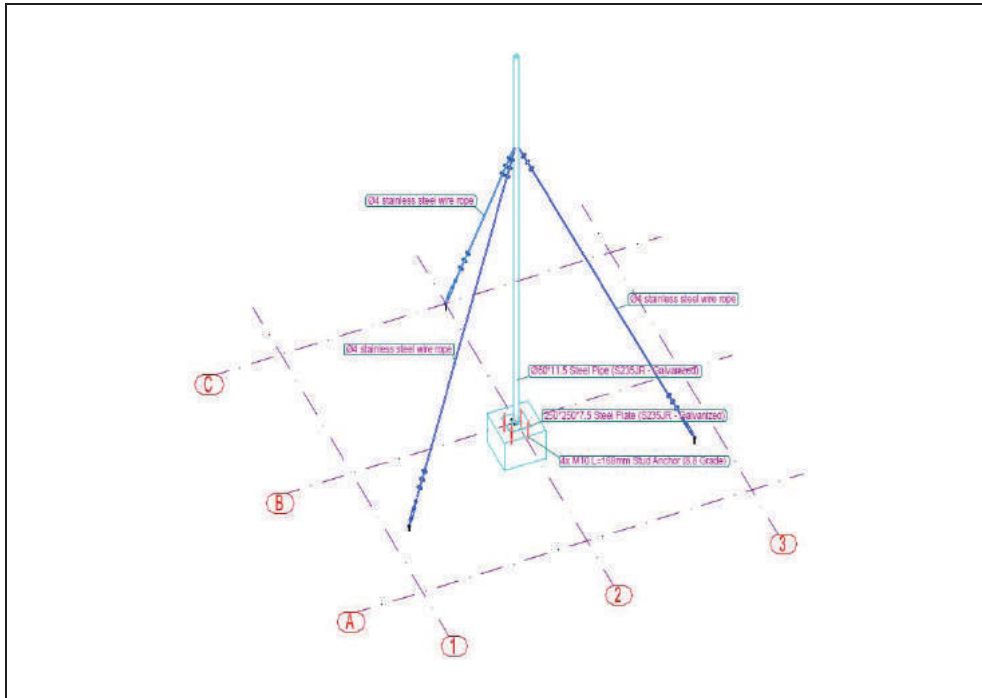



Fig. 4: Design of the foundation for erecting the tower

The soil must have a sufficient load-bearing capacity. The size and structure of the foundation depend on the soil characteristics.

	<p><b>Recommendation:</b> Ask a qualified structural engineer for advice regarding the optimal design of the foundation.</p>
---	--

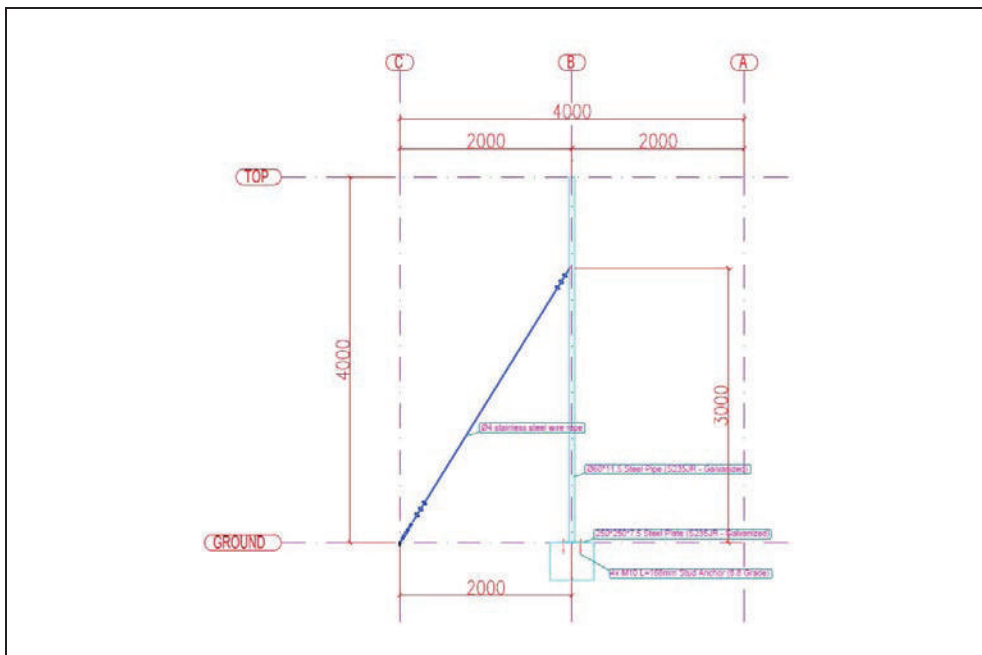

Fig. 5: Suitable guying system

### 7.3 Unpacking the components

- ▶ Carefully open the packaging.
- ▶ Check the shipment for completeness (refer to the shipping documents).
- ▶ Separate the packaging material and dispose of it in an environmentally responsible way.

### 7.4 Assembling the wind turbine

**⚠ WARNING!**

**Danger due to rotor imbalance!**

- ▶ Always replace the complete set of rotor blades.

**Risk of injury in case of assembly at windy sites!**

- ▶ Choose an assembly site which is sheltered from the wind.
- ▶ The assembly process requires calm weather conditions.

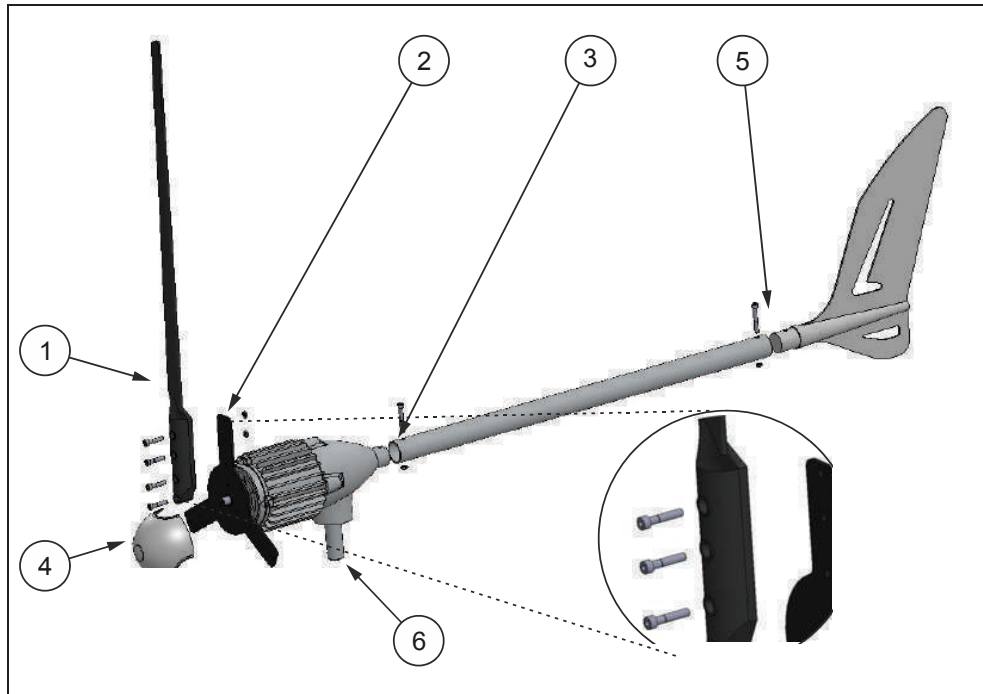



Fig. 6: Assembling the wind turbine

- ▶ For installation, select sheltered place.
- ▶ Hold propeller blade (1) with flat side to hub (2).
- ▶ Fasten with a M8x45 bolt, nut and one.
- ▶ Screw on further M8x45 screws and tighten by hand.
- ▶ Attach boom rod (3) with M8x60 bolt to alternator housing.
- ▶ Screw nose (4) to hub with M8x75 screw.
- ▶ Screw wind vane (5) to boom with M8x60 bolt.
- ▶ Plug - in pin 37 mm as mast connection



Fig. 7: Balancing the rotor (Y position)

- ▶ Move rotor to Y position (see Fig. 7)
- ▶ Carefully release rotor blade.
- ▶ Observe in which direction the rotor turns (the heavier rotor blade pushes downwards).
- ▶ Repeat the process for all three positions to determine which rotor blade is in imbalance.
- ▶ Check repeller for balance
- ▶ Tighten all screws to 25 Nm.
- ▶ Check balance again.
- ▶ Secure all screws with locking varnish.

	Note: The repellers have already been tested for equal weight by the manufacturer.
---	--

## 7.5 Electrical connections

<b>⚠ DANGER!</b>	
	<b>Danger: High voltage!</b> ▶ All work on electrical equipment must be carried out by a qualified electrician with the power switched off!

	Note: To ensure proper operation, you must use an original iSTA Breeze charge controller.
---	---

- ▶ Connect a three-wire cable with a suitable cross-section (refer to Table 9 / Table 10) and the required length to the generator.
- ▶ Make the electrical connections as shown in Fig. 1:.
- ▶ Connect the charge controller and the transformer as shown in the connection diagram (refer to the relevant documentation).

Distance between generator and charge controller [m]	< 11	11 – 18	18 – 29	20 – 44	44 – 68	68 – 110
Cable cross-section [mm <sup>2</sup> ]	2.5	4	6	10	16	25

Table 9 Cable cross-section with 24 V generator voltage

Distance between generator and charge controller [m]	< 11	11 – 18	18 – 29	20 – 44	44 – 70	68 – 113
Cable cross-section [mm <sup>2</sup> ]	2.5	4	6	10	16	25

Table 10 Cable cross-section with 48 V generator voltage



- ▶ Feed the three-wire cable through the tower right up to the top.
- ▶ Provide suitable strain relief.
- ▶ Connect the wires to the generator.

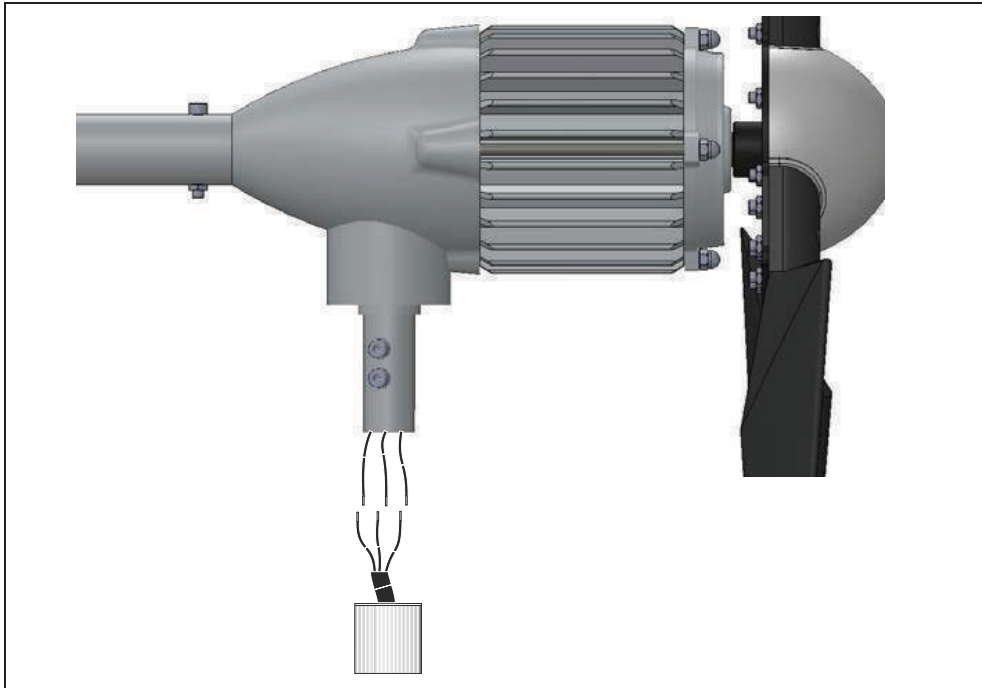

Fig. 8: Connecting the three-wire cable to the generator

- ▶ Short circuit all 3 phases to activate the generator brake.<sup>1</sup>
- ▶ Pull a suitable shrink tube over each wire of the cable.
- ▶ Twist and solder each wire of the cable to the wire from the generator
- ▶ Pull heat shrink tubing over the solder joint and shrink.
- ▶ Wrap each wire with textile insulating tape.

## 7.6 Erecting the wind turbine

### ⚠ WARNING!

#### **Danger due to unsuitable tower constructions!**

- ▶ Only use tested mast constructions or original iSTA Breeze masts.
- ▶ Choose a mast diameter <70 mm, so that the rotor blades are not pressed against the mast during a storm.

- ▶ Attach the wind turbine to the tower. Be careful not to damage the cable.
- ▶ Screw wind generator to mast.
- ▶ Erect the mast.
- ▶ Align the mast vertically in all directions.
- ▶ Brace the vertical mast (see Fig. 5)
- ▶ Kurzschluss aufheben.

<sup>1</sup> When using the iSTA Breeze charge controller, press the brake button

## 8 - Normal Operation -



For information on operating the iSTA Breeze charge controller, refer to the separate instructions.

### 8.1 Switching on the wind turbine system

- ▶ Unlock the emergency stop button or release the brake button on the iSTA Breeze charge controller.

- ✓ The brake is released.
- ✓ The fast-blinking red LED on the iSTA Breeze charge controller goes out.
- ✓ The wind turbine system supplies power.

### 8.2 Restart after an emergency

- ▶ Make sure the risk has been removed.
- ▶ Switch on the wind turbine system (→ section 7.1)

## 9 - Shutting down the Wind Turbine System -

### 9.1 Emergency shut-down

- ▶ Press the emergency stop button between the wind turbine and the charge controller.

- ✓ The wind turbine is short-circuited via the iSTA Breeze charge controller.
- ✓ The wind turbine is braked.

### 9.2 Temporary shut-down

- ▶ Press the “Charge controller OFF” button on the iSTA Breeze charge controller.

- ✓ Operation is interrupted.

### 9.3 Prolonged shut-down

- ▶ Press the “Charge controller brake OFF” button on the iSTA Breeze charge controller.

- ✓ The wind turbine is short-circuited via the iSTA Breeze charge controller.
- ✓ The wind turbine is braked.

- ▶ Carefully tilt the wind turbine.
- ▶ Clean the wind turbine (→ section 9.3)

## 10 - Maintenance -

### 10.1 Safety precautions during maintenance work

<b>⚠ WARNING!</b>
<b>Risk of injury when carrying out maintenance work!</b>
<ul style="list-style-type: none"> <li>▶ Shut down the wind turbine system prior to all maintenance work.</li> <li>▶ Take steps to prevent the wind turbine system from being switched on again by unauthorised persons.</li> </ul>

- ▶ Shut down the wind turbine system (→ section 8.2).
- ▶ Carefully tilt the tower.

### 10.2 Inspection and maintenance schedule

Interval	Part / component	Activity
Daily	Wind turbine	▶ Check for abnormal noises
	Rotor blades	▶ Check that the blades turn freely
	Tower	▶ Inspect for damage
Yearly <sup>2</sup> / at end of winter or after extreme weather events	Rotor blades	<ul style="list-style-type: none"> <li>▶ Inspect for cracks / damage and if necessary replace</li> <li>▶ Treat with underbody protection wax</li> <li>▶ Are the rotor blades balanced?</li> </ul>
	Tower	<ul style="list-style-type: none"> <li>▶ Check for vibration</li> <li>▶ Check the guy wires</li> <li>▶ Is the tower still aligned vertically?</li> <li>▶ Inspect for damage</li> </ul>
	Wind turbine	▶ Check the bolts
	Electrical wiring	▶ Inspect the cables for damage

Table 11 Inspection and maintenance schedule

<b>⚠ WARNING!</b>
<b>Danger due to damaged parts!</b>
▶ Shut down the wind turbine system immediately if the rotor blades or the electrical wiring are damaged.

Refer to the supplementary documents for information on maintaining supplier components.

### 10.3 Maintenance and cleaning by the user

- ▶ Coat the wind turbine and the rotor blades regularly with commercially available underbody protection wax using a soft cloth.

	A wax film protects the surfaces of the wind turbine and the rotor blades from the weather and increases the efficiency of the blades.
---	--

<sup>2</sup> Or every 6 months if situated close to sea

# 11 - Troubleshooting and Diagnostics -

## 11.1 Errors with LED

	Error messages are displayed on the iSTA Breeze charge controller. Refer to the separate instructions.
---	--

## 11.2 Errors without LED

Error	Possible cause	Possible actions
Wind turbine does not start up	Not enough wind	▶ None
	“Stop” switch pressed	▶ Release the “Stop” switch
Rotor turns too slowly	Rotor blades incorrectly attached	▶ Attach the rotor blades correctly
	Rotor blades not balanced	▶ Balance the rotor blades
	Bearing for wind alignment is stiff	▶ Replace the bearing
	Generator makes contact as it turns	▶ Send the generator in to the manufacturer
	Unfavourable location or tower too low	▶ Check and move to another location if necessary ▶ Increase the height of the tower
Wind turbine vibrates on tower	Rotor not balanced	▶ Balance the rotor
	Tower not aligned vertically	▶ Align the tower vertically
	Tower bends in the wind	▶ Design a more robust tower
	Tower foundation has too much clearance	▶ Reduce the clearance to a minimum
Wind turbine system produces too little power	Wind turbine or charge controller defective	▶ Contact the manufacturer or a specialist dealer
	Battery defective	▶ Replace the battery
	Battery too small	▶ Use a larger battery (at least 100 Ah)
	Battery fuse tripped	▶ Replace the fuse ▶ Check the electrical connections
	Cable cross-section does not match installed cable length	▶ Match the cable cross-section correctly

Table 12 Errors without an LED

	<p>Recommendation:</p> <p>Make a note of the relevant parameters at the site and have them handy when you contact the manufacturer / specialist dealer.</p>
---	---

1. What is the average / typical wind speed?
2. How high is the tower?

3. What are the characteristics of the countryside / built-up area in the vicinity of the wind turbine?
4. What is the voltage between phases (measured by a qualified electrician – this voltage should be roughly identical in identical wind conditions)?
5. What is the battery voltage? How old is the battery or batteries?
6. Which loads are connected to the battery?
7. Are solar panels also connected to the charge controller? If so:
  - a. What is the no-load voltage<sup>3</sup> [VDC]?
  - b. What is the power [Wp]?

### SUITABLE BATTERY CAPACITIES

Wind Turbine Model	Suitable Battery Capacities
Air Speed 12V / i-500 12V / L-500 12V	Min. 150 Ah - Max. 200 Ah
Air Speed 24V / i-500 24V / L-500 24V	Min. 2x75 Ah - Max. 2x100 Ah
i-700 12V	Min. 200 Ah - Max. 300 Ah
i-700 24V	Min. 2x100 Ah - Max. 2x150 Ah
i-700 48V	Min. 4x60 Ah - Max. 4x75 Ah
i-1000 24V	Min. 2x150 Ah - Max. 2x200 Ah
i-1000 48V	Min. 4x75 Ah - Max. 4x100 Ah
i-1500 24V	Min. 2x200 Ah - Max. 2x250 Ah
i-2000 48V	Min. 4x150 Ah - Max. 4x200 Ah
4000W 48V	Min. 8x150 Ah - Max. 8x200 Ah

The minimum battery values in the table are suitable for Turbine uses only.  
 Maximum battery values are for hybrid (turbine + solar) systems.  
 Also, in hybrid systems, wind turbine and solar panel should be used at equal capacities.  
 Example: 1kw 24v turbine + 1kw 24v solar = 2 \* 200 Ah battery  
 Example: 2kw 48v turbine + 2kw 48v solar = 4 \* 200 Ah battery

<sup>3</sup> Measured with no loads connected

## 12 - Removal from Service and Disposal -

### 12.1 Final decommissioning of the wind turbine system

<b>⚠ WARNING!</b>
<p><b>Risk of injury due to unqualified dismantling, e.g.</b></p> <ul style="list-style-type: none"> <li>• Persons without suitable training</li> <li>• Stored energy</li> <li>• Breakage during dismantling</li> </ul> <p>Important note on dismantling and disposal:</p> <ul style="list-style-type: none"> <li>▶ The system must be dismantled in the proper way by a suitably qualified person.</li> </ul>

- ▶ Shut down the wind turbine system (→ section 8).
- ▶ Have the electrical systems and equipment removed from service by a qualified electrician.
- ▶ Make sure all rotors are braked.
- ▶ Carefully tilt the tower.
- ▶ On the ground: Detach the rotor blades from the generator.
- ▶ Detach the generator from the tower and disconnect the electrical wiring.

### 12.2 Disposal of the wind turbine system and components

Where necessary, dispose of the individual components in consultation with the responsible local authorities.

Wind turbine system	
Wiring, electrical components	Dispose of as electronic scrap
Mechanical components	Segregate prior to disposal

Table 13 Disposal

**ISTA Breeze**

**EC / EU Declaration of Conformity (Translation)**  
as defined by the Directives  
2006/42/EC and 2014/30/EU

The Manufacturer:

ALTINEL ENERJİ DİŞ TİC.ELEK. ELEKTRONİK SAN.VE TİC.LTD.ŞTİ  
Mermerciler Sanayi Sitesi Merkezi 4 Cadde 3; TR - Beylikdüzü / İstanbul

declares under its own responsibility that the following product:

Product	Wind turbine system
Type designation	12 V – 48 V / 200 W – 4000 W
Serial No.	From date of signature

is in conformity with all provisions of the following EC / EU Directives:

2006/42/EC	Directive 2006/42/EC of the European Parliament and of the Council of 17 May 2006 on machinery, and amending Directive 95/16/EC (recast) (1)
2014/30/EU	Directive 2014/30/EU of the European Parliament and of the Council of 26 February 2014 on the harmonisation of the laws of the Member States relating to electromagnetic compatibility (recast)

The following harmonised standards were applied:

EN ISO 12100: 2011-03	Safety of machinery – General principles for design – Risk assessment and risk reduction
EN 60204-1: 2006/AC:2010	Safety of machinery - Electrical equipment of machines – Part 1: General requirements
EN 61400-2: 2014	Wind turbines - Part 2: Small wind turbines
EN 61000-6-1: 2007-10	Elektromagnetic compatibility (EMC) – Immunity standard for residential, commercial and light-industrial environments
EN 61000-6-3: 2011-09	Elektromagnetic compatibility (EMC) – Emission standard for residential, commercial and light-industrial environments
AC1: 2012-11	

Name and address of the authorised representative:  
IstaBreeze® Germany GmbH Riemenstr. 31, D-74906 Bad Rappenau

Beylikdüzü / İstanbul, 24/07/2018  
Place, Date

Erkan ÜRÜT  
Managing Director

ALTINEL ENERJİ DİŞ TİC.ELEKTRİK  
ELEKTRONİK SAN. VE TİC.LTD.ŞTİ  
Beylikdüzü O.S.8 MAHALLESİ  
7.CAD. NO : 8/2 Beylikdüzü / İST  
BEYLİKDÜZÜ V.D : 062 025 9423

Fig. 9: Declaration of conformity

<b>A</b>		<b>P</b>	
Adapter stud .....	8	Place of use .....	12, 13
<b>B</b>		<b>R</b>	
Battery .....	7, 10, 20, 21	Rotor blade .....	8, 9, 15, 16, 17,19,20, 22
<b>C</b>		<b>S</b>	
Cable cross-section .....	16, 20	Strain relief .....	17
Charge controller .....	7, 10, 11, 16, 17,18,20,21	<b>T</b>	
<b>F</b>		Tail vane .....	8
Foundation .....	14, 20	Transformer .....	16
<b>L</b>		<b>W</b>	
Load .....	10, 14, 21	Wind classes.....	13
<b>M</b>			
Main components.....	7, 8		





16

- Performance Charts -



**United States of America**  
United States Patent and Trademark Office

**ISTABREEZE**

Reg. No. 5,046,708  
Registered Sep. 20, 2016  
Int. Cl.: 7, 9  
Trademark  
Principal Register

Altinelenerji Ltd. (TURKEY LIMITED LIABILITY COMPANY)  
4 cad. kat3  
Mermerciler San. Sit. Laleli is merkezi,  
Istanbul-Beylikduzu TURKEY 34524

CLASS 7: Wind turbines, windmills, wind-powered electricity generators, propellers for wind-powered electricity generators  
FIRST USE 4-11-2013; IN COMMERCE 4-11-2013

CLASS 9: Electrical transformers, current rectifiers, electrical controllers, wind turbine controllers  
FIRST USE 4-11-2013; IN COMMERCE 4-11-2013

THE MARK CONSISTS OF STANDARD CHARACTERS WITHOUT CLAIM TO ANY PARTICULAR FONT STYLE, SIZE OR COLOR

SER. NO. 86-696,244, FILED 07-17-2015  
KRISTIN M DAHLING, EXAMINING ATTORNEY



*Michelle K. Lee*  
Director of the United States  
Patent and Trademark Office

**UNICERT**

**QUALITY MANAGEMENT SYSTEM  
CERTIFICATE**

Universal GmbH  
Certification Services

This certificate is granted to the organization,

**Altinel Enerji Dis Ticaret Elektrik Elektronik  
San. Ve Tic. Ltd. Sti.**

**Beylikduzu Osb. Mahallesi 7.Cadde No: 8/ 2 Beylikduzu/ Istanbul/ Turkey**



by review of IA2.007835 numbered report for the scope

**Production and Sales of Wind Turbines, Solar  
Panels, Controllers and Their Spare Parts**

to certify that a quality management system in accordance with  
standard's clauses is established and being implemented

**DIN EN ISO 9001:2015**

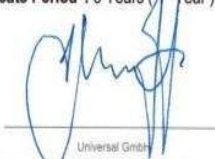
Certificate No : QMS 0118 007835  
Original Certification Date : 2018 - 01 - 17  
Issue / Revised Date : 2018 - 01 - 17  
Expiry Date : 2019 - 01 - 16  
Certificate Period : 3 Years (Year)

The authenticity of this certificate can be confirmed online or by e-mail to the Head Office via:  
UNIVERSAL GmbH • Wilfried-Diekmann-Str. 20b 44536 Lünen Germany • T. +49 (0) 231 9931 9960 • info@uni-cert.de • www.uni-cert.de

SAVE  
ENERGY  
SAVE  
PLANET



ISTA BREEZE®  
WIND TURBINES

IstaBreeze® Germany GmbH

Riemenstr .31

DE-74906 Bad Rappenau

+49 (0) 7264 - 7024134

[www.istabreeze.com](http://www.istabreeze.com)

© ISTA Breeze – No part of this document may be copied or reproduced