



LED Pix Panel

PAN8X1X30, PAN4x1x30 ,PAN4x1x15, PAN2x1x30

USER MANUAL



For safety, please read this user manual carefully before initial use.

Event Lighting reserves the right to revise the manual at any time. Information and specifications within this manual are subject to change without notice. Event Lighting assumes no liability or responsibility for any errors or omissions. Please consult Event Lighting for any clarification or information regarding this item.

www.event-lighting.com.au

Ver 2.0

CONTENTS

Safety Instructions

- Power Input & Power Linking

Product Installation

- Fuse replacement

Product appearance

- Lux Chart
- Dimensions

Control Board Operation

- DMX Addressing
- DMX Modes
- Dimmer Speed Setting
- Sound Mode
- Setting Static Colors
- User Mode
- Automatic Mode

DMX Values

Technical Specifications

Warranty

Safety Instructions

WARNING

- Do not open this device, there is no user-serviceable parts inside. Risk of electric shock.
- Do not look at the light source when the device is on.
- **CAUTION:** This unit's housing may be hot during and after operation.
- Install this device in a location with adequate ventilation, at least 20 inch (50 cm) from adjacent surfaces.
- Do not leave any flammable material within 50 cm of this unit while operating or connected to power.
- Use a safety chain when mounting this device overhead.
- Do not operate this device outdoors or in any location where dust, excessive heat, water, or humidity may affect it.
- Do not operate this device if the housing, lenses, or cables appear damaged.
- Do not connect this device to a dimmer or rheostat.
- ONLY connect this device to a grounded and protected circuit.
- ONLY use the hanging bracket to carry this device.
- In case of a serious operating problem, stop using immediately.
- The maximum ambient temperature is 104° F (40° C). Do not operate this device at higher temperatures.

Power Input & Power Linking

This device has an auto-switching power supply work with input voltage range of 100~240 VAC, 50/60 Hz.

Link up to the maximum 8A. DO NOT exceed this.

Fuse Replacement

If the fine-wire fuse of the device fuses, only replace the fuse by a fuse of same type and rating.

Before replacing the fuse, unplug mains lead.

Procedure:

Step 1: Unscrew the fuse holder on the rear panel with a fitting screwdriver from the housing (anticlockwise).

Step 2: Remove the old fuse from the fuse holder.

Step 3: Install the new fuse in the fuse holder.

Step 4: Replace the fuse holder in the housing and fix it.

Product Installation

This device can be mounted in many orientations provided each individual device is secured by the use of correct mounting bracket.

Use a safety chain when mounting this device overhead.

PRODUCT APPEARANCE, LUX CHART, DIMENSIONS

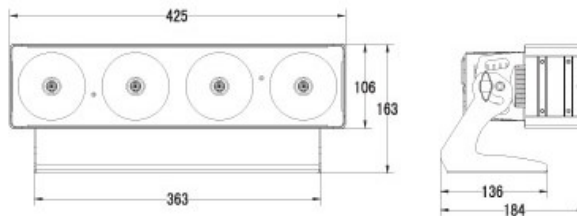
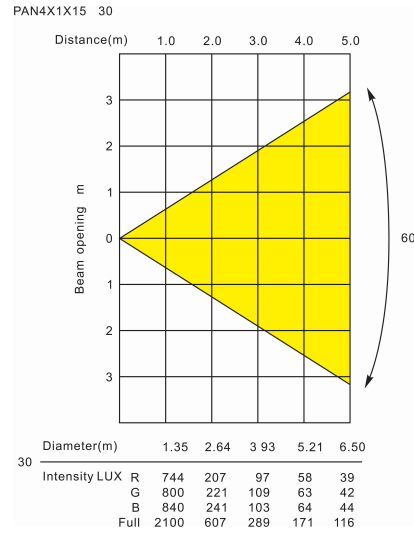
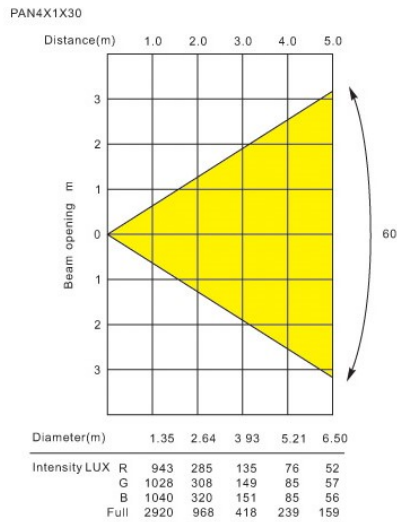
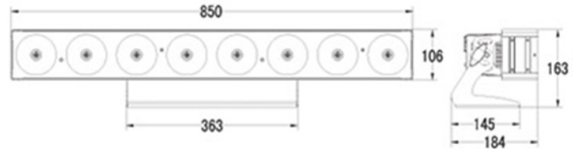
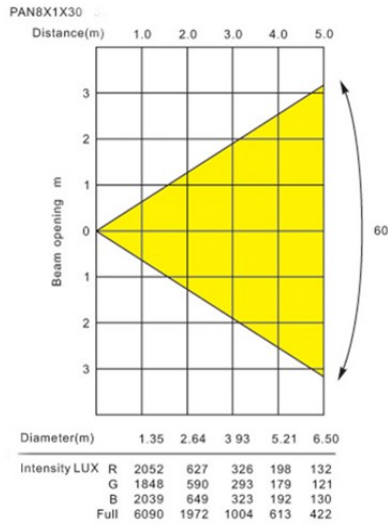

PAN2X1X30 30

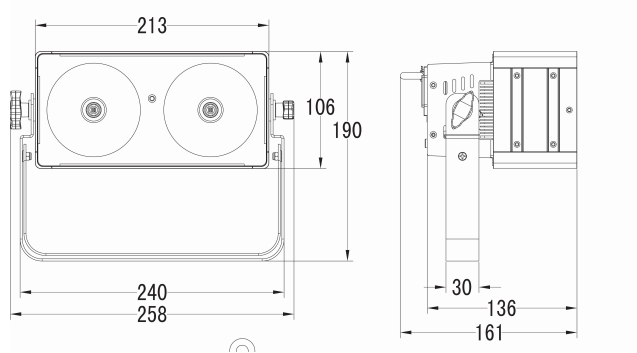
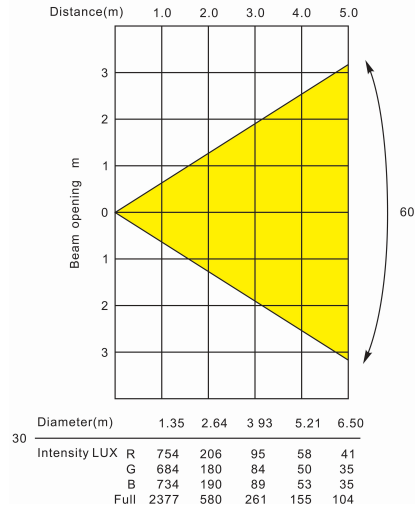

CONTROL BOARD OPERATION

Press the Menu until one of the following had been displayed:

Display	Function
1.DMX Address	To set DMX address
2.DMX Channel	To set DMX channel modes: 4x1 Models - CH 03, CH 05, CH 09, CH12, CH17 2x1 Model - CH 03, CH 05, CH 06, CH09, CH11
3.Dimmer Curve	To set dimmer speeds: 01, 02, 03, 04, 05
4.Sound Mode	To set sound active mode and the sensitivity (Sen 000 ~ Sen100)
5.Static Color	To set static colors: R, G, B, RG, GB, RB, RGB
6.Manual Color	To set intensity of R, G, B separately for color mixing and strobe rate
7.Auto Program	To set built-in automatic programs and speed 000 ~100
8.Master/Slave	To set Master/Slave modes
9.Factory Set	To recover to manufactory default

Use "Up" and "Down" button to select your desired operation, press "Enter" to set all function

Set DMX address

After select the "DMX Address" and press "Enter", then use "Up" and "Down" to set the desired DMX address, press "Enter" again to confirm.

Set DMX modes

After select the "DMX Channel" and press "Enter", then use "Up" and "Down" to set the desired DMX mode, press "Enter" again to confirm.

Set Dimmer curve

After select the "Dimmer Curve" and press "Enter", then use "Up" and "Down" to set the desired dimmer curve, press "Enter" again to confirm.

Sound Mode

After select the "Sound mode", use "Up" and "Down" to set the sound sensitivity Sen 000 ~ Sen 100, press "Enter" to confirm.

Set Static Colors

Entered "Static Color", you can select the desired solid color via the "Up" or "Down" buttons, then "Enter" to confirm

Mode:	Value:	Function:
Static Color	Static color <R>	Red
	Static color <G>	Green
	Static color 	Blue
	Static color <RG>	Red + Green
	Static color <BG>	Green + Blue
	Static color <RB>	Red + Blue
	Static color <RGB>	Red + Green + Blue

Set manual mode Set up intensity of R, G, B separately for your color mixing and strobe function through control panel.

Entered "Manual color", use "Up" and "Down" to select intensity of R G B, use "Enter" to save your set for each step.

Use "Up" and "Down" to set strobe speed from Sp 000 to Sp 100, ("0" is freeze, "001 – 100" is slow to fast), then press "Enter" to confirm.

Automatic Mode

Set your built-in automatic program through control panel.

Entered "Auto Program" mode, use "Up" and "Down" to select the built-in auto run programs, press "Enter" to confirm.

Use "Up" and "Down" to select the operating speed of the auto program (Sp 000 ~ Sp100, freeze, slow ~ fast)

	PAN2X1X30	PAN4X1X15 & PAN4X1X30 & PAN8X1X30
Pr 01	R G B colors switching	R G B colors switching
Pr 02	7 colors switching	7 colors switching
Pr 03	R G B colors fading	R G B colors fading
Pr 04	7 colors Fading	7 colors Fading
Pr 05	Color Macros Fading	Color Macros Fading
Pr 06	Effect program	Effect program 1
Pr 07	Multi fixture chases 1	Effect program 2
Pr 08	Multi fixture chases2	Effect program 3
Pr 09	Multi fixture chases 3	Effect program 4
Pr 10	Multi fixture chases 4	Effect program 5
Pr 11	Multi fixture chases 5	Effect program 6
Pr 12	N/A	Effect program 7
Pr 13	N/A	Effect program 8
Pr 14	N/A	Effect program 9
Pr 15	N/A	Effect program 10
Pr 16	N/A	Effect program 11
Pr 17	N/A	Multi fixture chases 1
Pr 18	N/A	Multi fixture chases2
Pr 19	N/A	Multi fixture chases 3
Pr 20	N/A	Multi fixture chases 4
Pr 21	N/A	Multi fixture chases 5

To setup multi fixture chases

Before starting, go to each fixture and reset the menu to fixture defaults.

1. On the master unit, setup the DMX address to the total number of fixtures in the string. For example, you may have a total of 20 par cans including the master, so the DMX address should be set to "20".
2. On the master unit, go to master/slave menu setting and set the unit to master
3. On the master unit, set the unit to "Auto Mode" "PrXX" which supports multi fixture chases.
4. On each slave unit, setup the DMX address to the fixture position in the string. For example, if this unit is the 2nd unit in the string including the master, then set the DMX address to 2. If this the last unit of 20, then the DMX address should be set to 20. It is possible to double up fixture positions as well as fixture 1.
5. On each slave, go to the master/slave menu setting and set it to slave.

Master/Slave Operation

1. Set the master fixture to one of the standalone operating modes: auto, sound, static color or manual color modes
2. Set the slaves, entered "Mas/Sla" mode, set to "s", press "Enter"

Factory set

To recover factory default, select the "Factory Set" and press "Enter", then use "Up" and "Down" to choose "Y" (yes), press "Enter" again to confirm to recover factory default

DMX VALUES

3 channels mode

Channel	Value	Function
1	000-255	Red: 0% ~ 100%
2	000-255	Green: 0% ~ 100%
3	000-255	Blue: 0% ~ 100%

5 channels mode

Channel	Value	Function
1	000-255	Red: 0% ~ 100%
2	000-255	Green: 0% ~ 100%
3	000-255	Blue: 0% ~ 100%
4	000-255	Master dimmer 0% ~ 100%
5	000-009	No function
	010-255	Strobe : Slow ~ Fast (1~30Hz)

6/12/24 channels mode

PAN2X1X30	PAN4X1X30 PAN4X1X15	PAN8X1X30	Value	Function
1	1	1	000-255	LED 1 Red: 0% ~ 100%
2	2	2	000-255	LED 1 Green: 0% ~ 100%
3	3	3	000-255	LED 1 Blue: 0% ~ 100%
4	4	4	000-255	LED 2 Red: 0% ~ 100%
5	5	5	000-255	LED 2 Green: 0% ~ 100%
6	6	6	000-255	LED 2 Blue: 0% ~ 100%
	7	7	000-255	LED 3 Red: 0% ~ 100%
	8	8	000-255	LED 3 Green: 0% ~ 100%
	9	9	000-255	LED 3 Blue: 0% ~ 100%
	10	10	000-255	LED 4 Red: 0% ~ 100%
	11	11	000-255	LED 4 Green: 0% ~ 100%
	12	12	000-255	LED 4 Blue: 0% ~ 100%
		13	000-255	LED 5 Red: 0% ~ 100%
		14	000-255	LED 5 Green: 0% ~ 100%
		15	000-255	LED 5 Blue: 0% ~ 100%
		16	000-255	LED 6 Red: 0% ~ 100%
		17	000-255	LED 6 Green: 0% ~ 100%
		18	000-255	LED 6 Blue: 0% ~ 100%
		19	000-255	LED 7 Red: 0% ~ 100%
		20	000-255	LED 7 Green: 0% ~ 100%
		21	000-255	LED 7 Blue: 0% ~ 100%
		22	000-255	LED 8 Red: 0% ~ 100%
		23	000-255	LED 8 Green: 0% ~ 100%
		24	000-255	LED 8 Blue: 0% ~ 100%

9 channels mode

PAN2X1X30	PAN4X1X30 PAN4X1X15 PAN8X1X30	Value	Function	
1	1	000-255	Red: 0% ~ 100%	
2	2	000-255	Green: 0% ~ 100%	
3	3	000-255	Blue: 0% ~ 100%	
4	4	000-255	Master dimmer 0% ~ 100%	
5	5	000-009	Strobe OFF	
		010-255	Strobe (slow-fast 1-30Hz)	
6	6	000-019	No Function	
		020-039	RED 100% / GREEN 0% ~ 100% / BLUE 0%	
		040-059	RED 100% ~ 0% / GREEN 100% / BLUE 0%	
		060-079	RED 0% / GREEN 100% / BLUE 0% ~ 100%	
		080-099	RED 0% / GREEN 100% ~ 0% / BLUE 100%	
		100-119	RED 0% ~ 100% / GREEN 0% / BLUE 100%	
		120-139	RED 100% / GREEN 0% / BLUE 100% ~ 0%	
		140-159	RED 100% / GREEN 0% ~ 100% / BLUE 0% ~ 100%	
		160-179	RED 100%~ 0% / GREEN 100% ~ 0% / BLUE 100%	
		180-200	RED 100% / GREEN 100% / BLUE 100%	
		201-204	Color Temperature 1	<p style="text-align: center;">Warm</p> <p style="text-align: center;">↓</p> <p style="text-align: center;">Cool</p>
		205-209	Color Temperature 2	
		210-214	Color Temperature 3	
		215-219	Color Temperature 4	
		220-224	Color Temperature 5	
		225-229	Color Temperature 6	
		230-234	Color Temperature 7	
235-239	Color Temperature 8			
240-244	Color Temperature 9			
245-249	Color Temperature 10			
250-255	Color Temperature 11			
7		000-009	No Function	
		010-043	R G B W colour switching	
		044-078	7 colour switching	
		079-113	R G B W colour fading	
		114-148	7 colour fading	
		149-183	Color Macros Fading	
		184-218	Effect program	
		214-255	Sound active mode	
		000-009	No Function	
		010-023	R G B colors switching	
		024-038	7 colors switching	
		039-053	R G B colors fading	

	7	054-068	7 colors Fading
		069-083	Color Macros Fading
		084-098	Effect program 1
		099-113	Effect program 2
		114-128	Effect program 3
		129-143	Effect program 4
		144-158	Effect program 5
		159- 173	Effect program 6
		174-188	Effect program 7
		189-203	Effect program 8
		204-218	Effect program 9
		219-233	Effect program 10
		234-248	Effect program 11
		249-255	Sound active mode
8	8	000-255	Speed of auto programs (slow ~ fast) or sound sensitivity
9	9	000-009	Use dimmer curve from setting of control board
		010-044	16 bits Linear dimmer 1
		045-079	16 bits Non-linear dimmer 2
		080-114	16 bits Non-linear dimmer 3
		115-149	16 bits Non-linear dimmer 4
		150-184	8 bits Linear dimmer 5
		185-219	Switch on colour temperature mode
		220-255	Switch off colour temperature mode

11/17/29 channels mode

PAN2X1X30	PAN4X1X30 PAN4X1X15	PAN8X1X30	Value	Function
1	1	1	000-255	LED 1 Red: 0% ~ 100%
2	2	2	000-255	LED 1 Green: 0% ~ 100%
3	3	3	000-255	LED 1 Blue: 0% ~ 100%
4	4	4	000-255	LED 2 Red: 0% ~ 100%
5	5	5	000-255	LED 2 Green: 0% ~ 100%
6	6	6	000-255	LED 2 Blue: 0% ~ 100%
	7	7	000-255	LED 3 Red: 0% ~ 100%
	8	8	000-255	LED 3 Green: 0% ~ 100%
	9	9	000-255	LED 3 Blue: 0% ~ 100%
	10	10	000-255	LED 4 Red: 0% ~ 100%
	11	11	000-255	LED 4 Green: 0% ~ 100%
	12	12	000-255	LED 4 Blue: 0% ~ 100%
		13	000-255	LED 5 Red: 0% ~ 100%
		14	000-255	LED 5 Green: 0% ~ 100%
		15	000-255	LED 5 Blue: 0% ~ 100%
		16	000-255	LED 6 Red: 0% ~ 100%
		17	000-255	LED 6 Green: 0% ~ 100%
		18	000-255	LED 6 Blue: 0% ~ 100%
		19	000-255	LED 7 Red: 0% ~ 100%
		20	000-255	LED 7 Green: 0% ~ 100%
		21	000-255	LED 7 Blue: 0% ~ 100%
		22	000-255	LED 8 Red: 0% ~ 100%
		23	000-255	LED 8 Green: 0% ~ 100%
		24	000-255	LED 8 Blue: 0% ~ 100%
7	13	25	000-255	Master dimmer 0% ~ 100%
8	14	26	000-009	Strobe OFF
			010-255	Strobe (slow-fast 1-30Hz)
9			000-009	No Function
			010-043	R G B W colour switching
			044-078	7 colour switching
			079-113	R G B W colour fading
			114-148	7 colour fading
			149-183	Color Macros Fading
			184-218	Effect program
214-255	Sound active mode			
			000-009	No Function
			010-023	R G B colors switching
			024-038	7 colors switching
			039-053	R G B colors fading

	15	27	054-068	7 colors Fading
			069-083	Color Macros Fading
			084-098	Effect program 1
			099-113	Effect program 2
			114-128	Effect program 3
			129-143	Effect program 4
			144-158	Effect program 5
			159-173	Effect program 6
			174-188	Effect program 7
			189-203	Effect program 8
			204-218	Effect program 9
			219-233	Effect program 10
			234-248	Effect program 11
			249-255	Sound active mode
10	16	28	000-255	Speed of auto programs (slow ~ fast) or sound sensitivity
11	17	29	000-009	Use dimmer curve from setting of control board
			010-044	16 bits Linear dimmer 1
			045-079	16 bits Non-linear dimmer 2
			080-114	16 bits Non-linear dimmer 3
			115-149	16 bits Non-linear dimmer 4
			150-184	8 bits Linear dimmer 5
			185-219	Switch on colour temperature mode
			220-255	Switch off colour temperature mode

TECHNICAL SPECIFICATIONS

Model	PAN2X1X30	PAN4X1X30	PAN4X1X15	PAN8X1X30
Dimensions and Weight				
Overall size LxWxH (mm)	258X161X190	425X184X163		850X184X163
Weight (kg)	2.5	4		6.2
Power				
Power Supply	100~240V AC, 50/60 Hz			
Power Consumption (w)	50	120	60	200
Fuse	T 1 A, 250 V	T 2 A, 250 V	T 1 A, 250 V	T 8 A, 250 V
LED	2pcs 30W RGB COB LED	4pcs 30W RGB COB LED	4pcs 15W RGB COB LED	8pcs 30W RGB COB LED
Operation Modes	DMX, auto run, sound active, master/slave, manual colour control, static colour control			
Beam Angle	60°			
Refresh Rate	11,700Hz			
DMX Channel mode	3/5/9/6/11	3/5/9/12/17		3/5/9/24/29
Power Input	IEC			
Power Output	NO	IEC		

WARRANTY

Please refer to your local dealer or please contact Event Lighting Pty Ltd

Website: www.event-lighting.com.au.