



DNG-250 Low Fog Generator User Manual

- ENGLISH
- 中文



DNG-250 **LOW FOG GENERATOR**

© 2019 Antari Lighting and Effects Ltd.

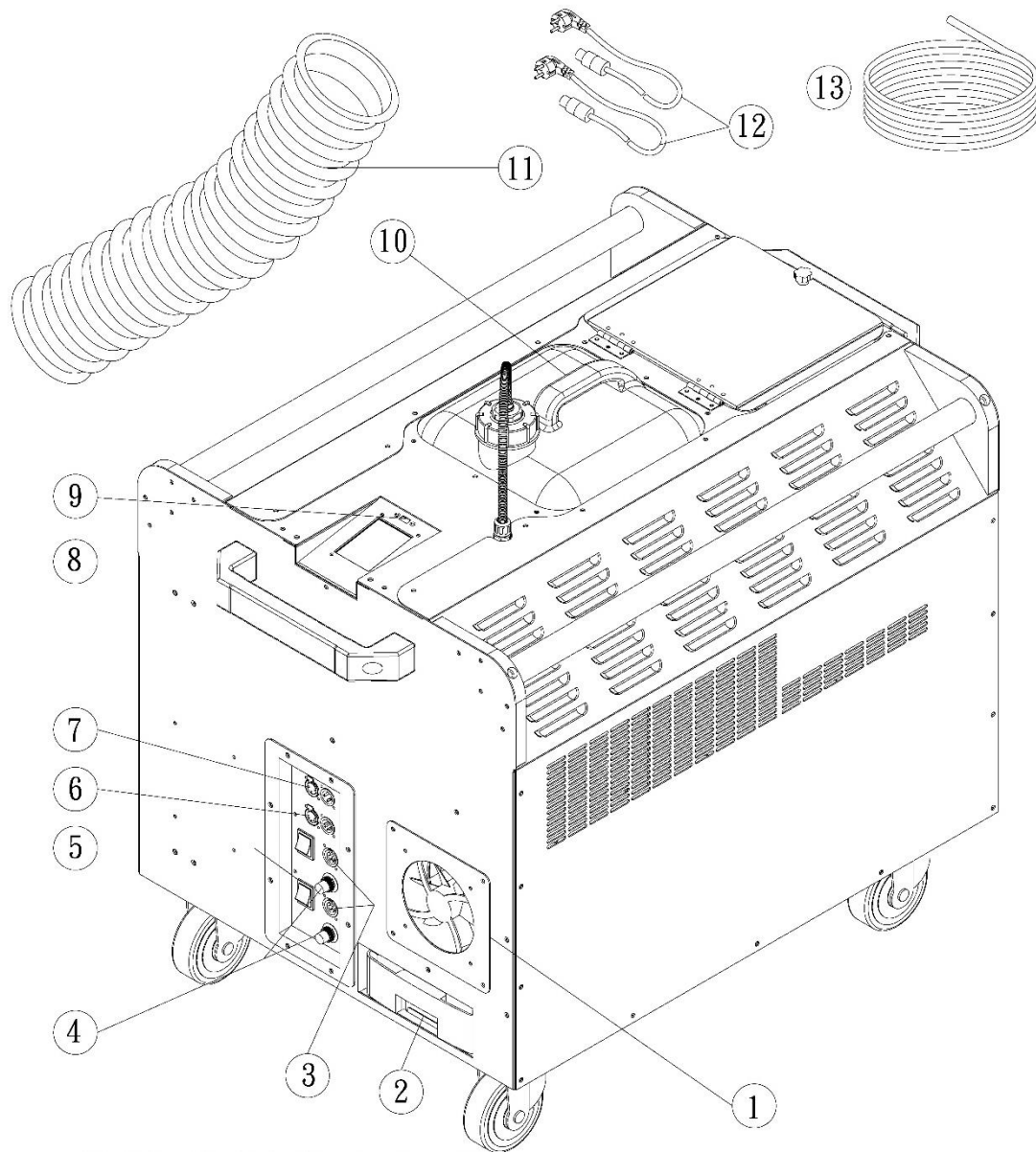

Spare Parts of **DNG-250**
LOW FOG GENERATOR

- | | |
|-----------------------|-------------------------|
| 1. Fan | 8. LCD-TFT |
| 2. Catchment | 9. USB |
| 3. Power Socket | 10. Tank & tank cap |
| 4. Resettable Fuse | 11. Fog Conducting Hose |
| 5. Rocker Switch | 12. Power Cord & Plug |
| 6. P.C Board DMX 5Pin | 13. Pu Tube |
| 7. P.C Board DMX 3Pin | |

DNG-250 LOW FOG GENERATOR

Thank you for choosing Antari's DNG-250 Low Fog Generator. The machine has some terrific new features on top of the ones of its previous version DNG-200. With the 3.5 TFT color touch panel, users can operate more easily. The dimension is exactly the same as DNG-200, but the output volume and continuity are comprehensively increased, hence a total up-grade in performance. No CO₂ is needed for DNG-250 Low Fog Generator; therefore, there's no risk to human body nor environment. DNG-250 is a real green effect machine.

Please follow these operation, safety and maintenance instructions to ensure a longer and safe life of your DNG-250 Low Fog Generator.

Pay attention to all warning labels and instructions printed on the exterior of the machine.

Safety Instructions

If you have questions about how to operate the machine safely, please contact your local Antari dealer for help.

- Keep this device dry.
- Always connect to a grounded circuit to avoid risk of electrocution.
- Before connecting the machine to power, always check the voltage indicated on the machine matches to your local AC voltage. Do not use the machine if AC power voltage does not match.
- Disconnect the machine from AC power before servicing and when not in use.
- If the supply cord is damaged, contact your local Antari dealer for replacement.
- This product is for indoor use only! Do not expose to rain or moisture. If fluid is spilled, disconnect AC power and clean with a damp cloth. If fluid is spilled onto electronic parts, immediately unplug the machine and contact your local Antari dealer for advice.
- No user serviceable and modifiable parts inside. Never try to repair this product, an unauthorized technician may lead the machine to damage or malfunction.
- For adult use only. Children being supervised not to play with the machine. Never leave the machine running unattended.
- The machine is not to be used by persons (including children) with reduced physical, sensory or mental capabilities, or lack of experience and knowledge.

- Installed in a well ventilated area. Provide at least 50 cm space around the machine.
- Never add flammable liquid of any kind to the machine.
- Make sure there are no flammable materials close to the machine while operating.
- Only use Antari fluid. Other fluid may lead to heater clog and malfunction.
- If the machine fails to work, unplug the machine and stop operation immediately. Contact your local Antari dealer for .
- Before transporting the machine, make sure the fluid tank is completely drained.
- Smoke fluid may present health risks if swallowed. Do not drink smoke fluid. Store it securely. In case of eye contact or if fluid is swallowed immediately look for medical advice.

Unpacking and Inspection

Open the shipping carton and verify that all equipment necessary to operate the system has arrived intact. If any shortage or damage due to transportation, please contact your Antari dealer and send back with original packaging for inspection. The shipping carton should contain the following items:

- DNG-250 Low Fog Generator
- Two power cords for connecting to Neutrik PowerCon connectors.
- 3M fog conducting hose
- User's manual (item 2-4 placed in the compartment on the top of the machine)
- Water collection tray (preinstalled in the machine)
- 3M PU tube, 6mmØ

Setup

- The wheels at the bottom of the DNG-250 help to move the machine; wheel fixing mechanisms are located at the diagonal line. Position the machine at a spot, press down the fixing mechanism to prevent it from moving. To move the machine, press the opposite side of the fixing mechanism to release it. Please note that the machine is not allowed to place on a slope due to its big size. (refer to figure 1)

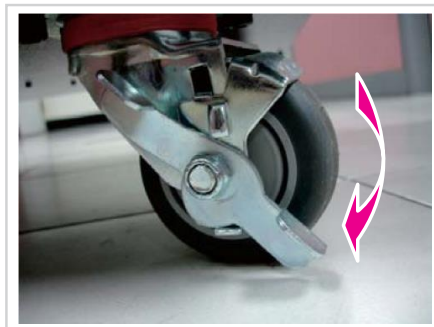

Figure

- Please aim the key on the PowerCon terminal of the power cord to the slot of the connector on the machine, plug it in and turn it about 10° clockwise until the power cord is completely fixed. The upper power cord is for the fog generator and the bottom one is for the compressor. (refer to figure 2 and 3)

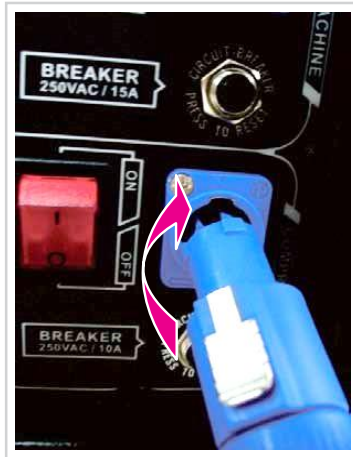

Figure



Figure

- Before connecting the machine to power supply, make sure to check the needed voltage and watt indicated on the metal plate of the machine.
- Connect the machine with the black fog conducting hose; it is a three-meter pipe. The length of the pipe can be adjusted to fit the actual need. (refer to figure 4)
- Fill Antari FLL Low Fog Effects Fluid to the tank, tighten the tank cap. (refer to figure 5)



Figure4



Figure5

Operation

1. After confirming the voltage, connect the power cord to a grounded outlet then turn on the lower power switch and then the higher one. The warmup starts now, and the TFT touch panel will show the percentage of the whole warmup process until 100% that the warmup is completed.

2. TFT touch panel introduction :

2-1 Main Menu :

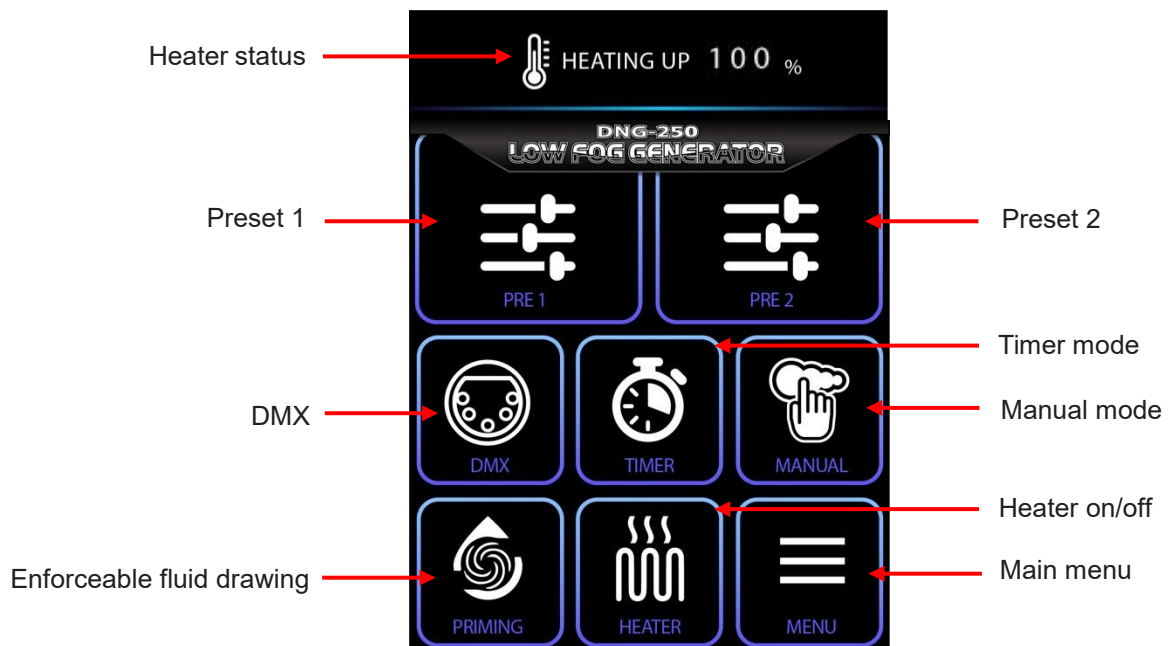

2-2 Manual mode :

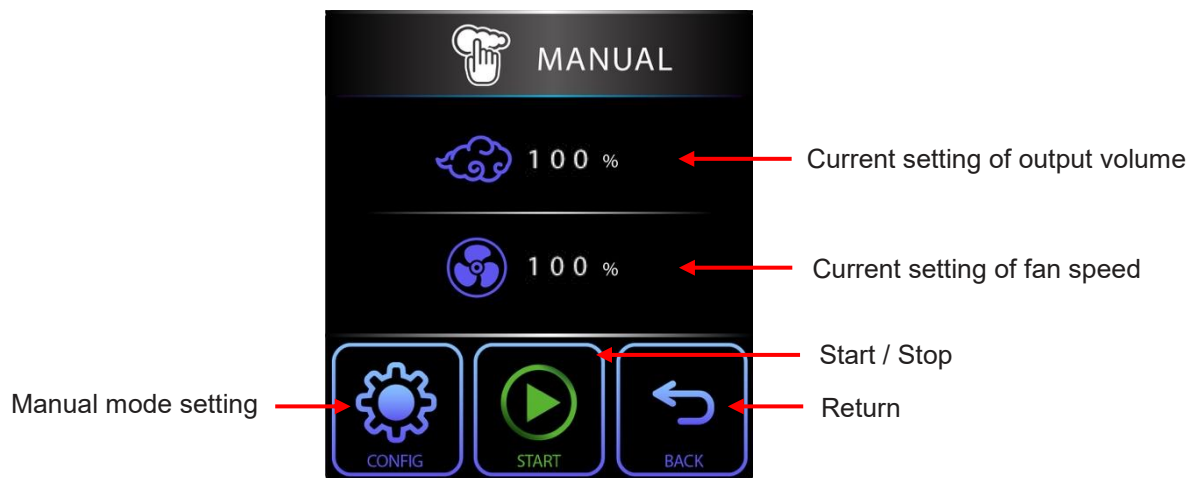



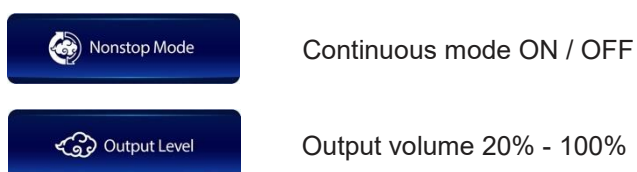

2-2-1 Manual mode setting :

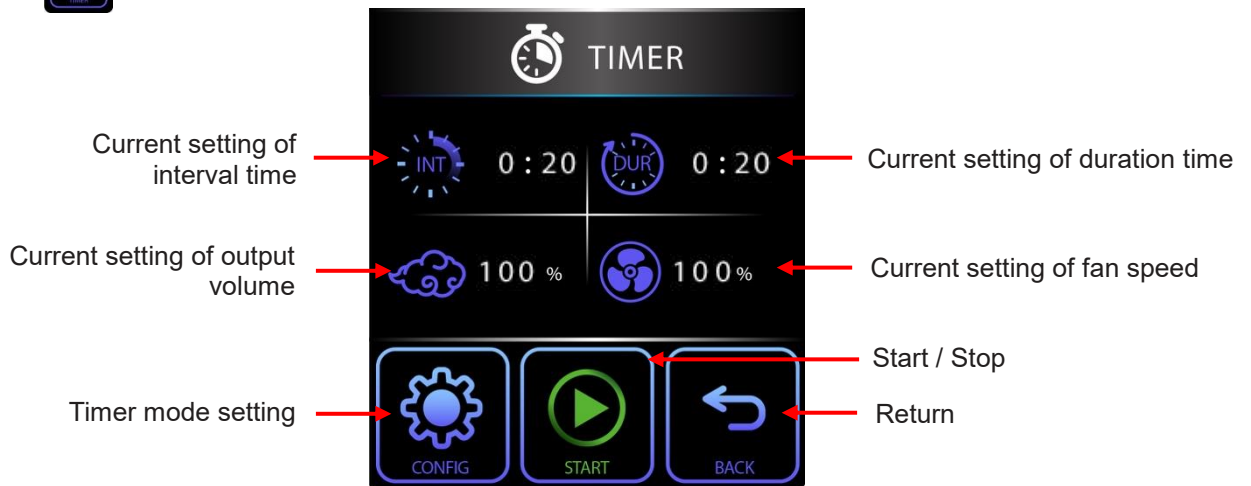

2-3  **Timer mode :**



2-3-1  **Timer mode setting:**

 Interval	Interval 5 secs – 200 secs
 Duration	Duration 5 secs – 200 secs
 Nonstop Mode	Continuous mode ON / OFF
 Output Level	Output volume 20% - 100%

2-4  **DMX :**

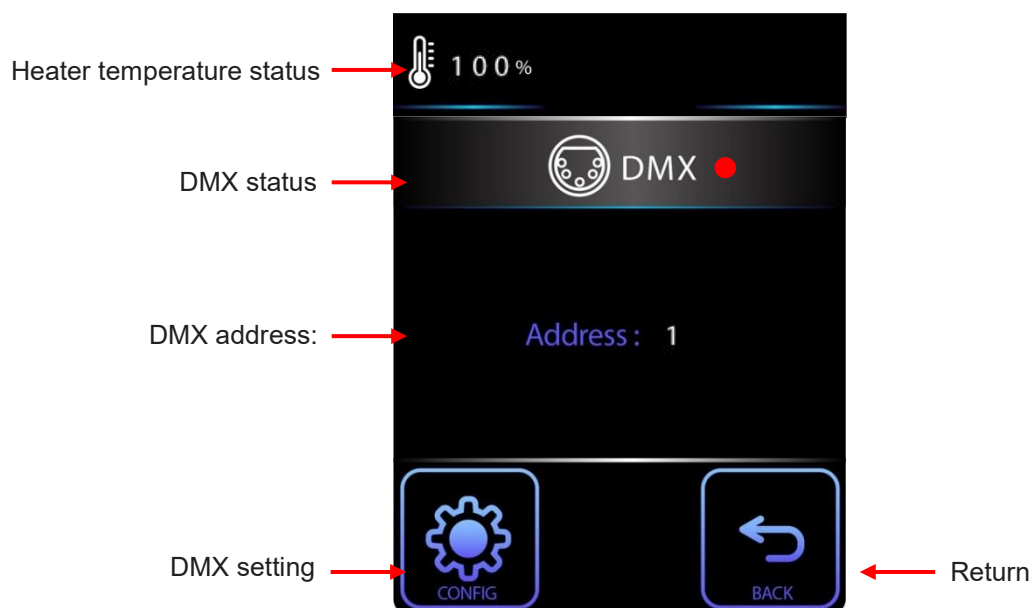

2-4-1 DMX setting :

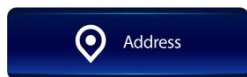

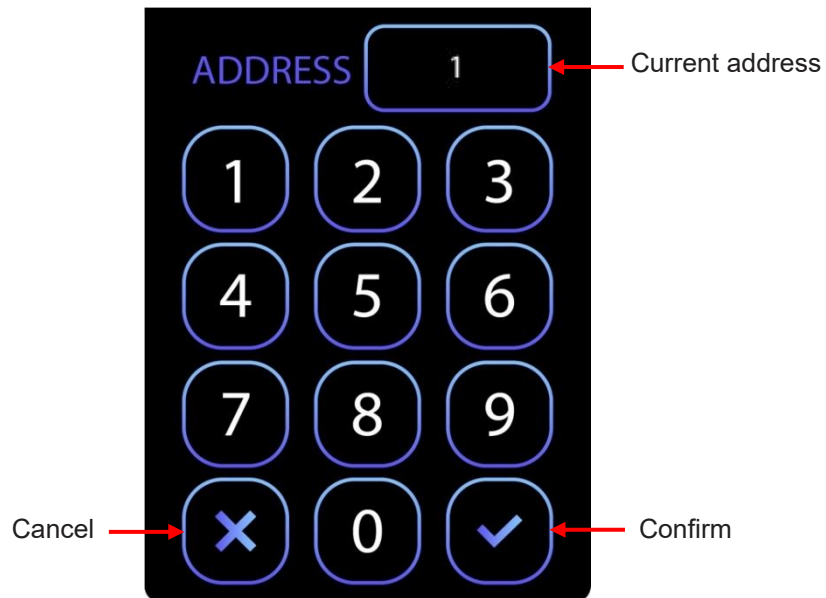

DMX address setting



2-5 Enforceable fluid drawing:

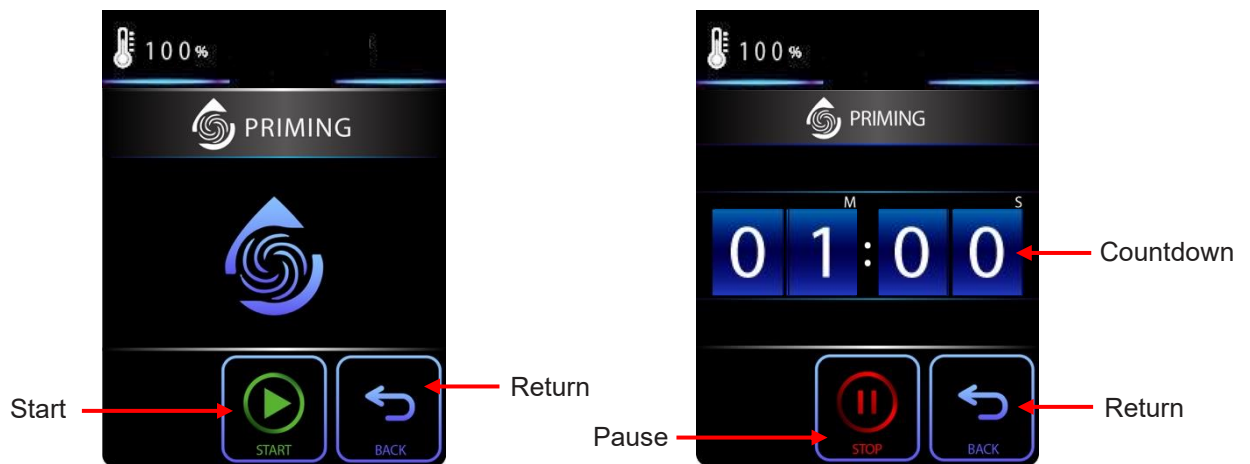





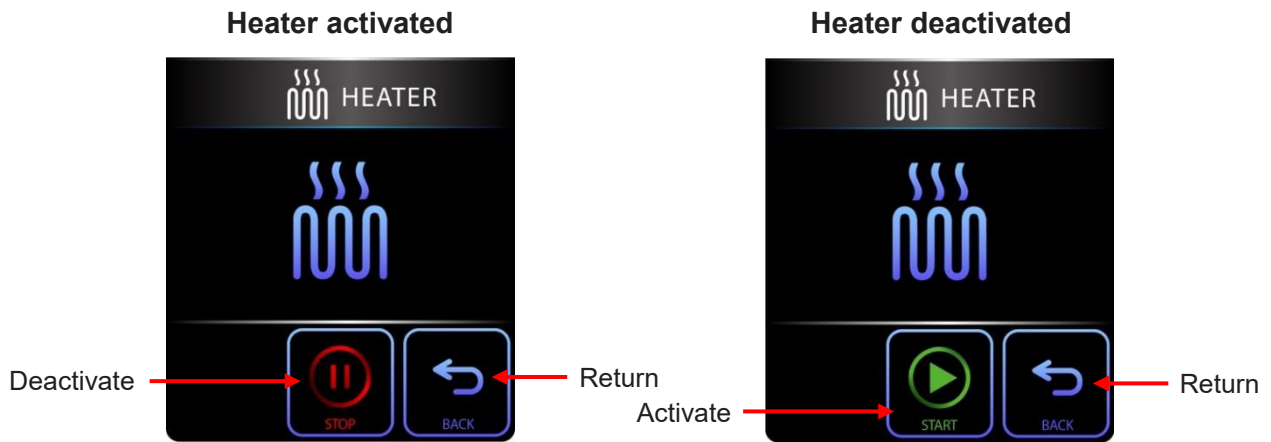



When the tank is refilled with fog fluid, use this to draw the fluid. Press "Pause" once the output is back to avoid damp in fog. Default duration of the fluid drawing is 1 min.



2-6  **Heater** : Heater can be activated or deactivated manually. Default setting is activated.



2-7  **Main menu :**

- 2-7-1  DMX Setup **DMX setting**
DMX address setting. Please refer to page 8 for detail.
- 2-7-2  Information **Basic information**
 -  Software Version Software version
 -  Operating Voltage Setting Current working voltage (settable)
 -  Device Hour Usage time (from power on)
- 2-7-3  Setting **Setting**
 -  LCD Backlight LCD brightness (Low/Medium/High/Auto)
*LCD light will shut down in 1 min when "Auto" is selected.
 -  Auto Start Action before shut down will be automatically proceeded after warming up is finished.
 -  Factory Reset Restore default setting.
 -  Language Chinese/English
 -  Software Update Software update (for Antari's distributors' use only)

DMX Connector Pin Assignment & instruction

- 3-1** The machine provide 3 or 5 pin XLR connector for DMX connection.
Diagram below indicate pin assignment information.

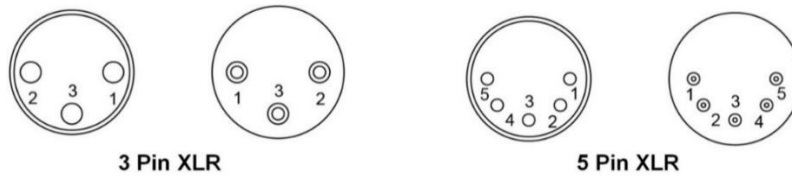

Pin	Function
1	Grounding
2	Data -
3	Data +

3-2 DNG-250 DMX instruction

DNG-250 low fog generator has built-in DMX 512 function with 3 Pin and 5 Pin sockets to choose from. After connecting to DMX, TFT touch panel can't be used, and all actions are controlled by DMX. Only DMX address can be entered with TFT touch panel.

3-3 DMX 512 settings

Function	Figures	Meaning
Output Volume	0 - 4	Off
	5 - 255	1 - 100%

RDM Function

4-1 RDM (Remote Device Management) Function

DNG-250 is equipped with RDM function which allows users to control the unit through devices with RDM ANSI E1.20 protocol. This is a protocol enhancement that allows bi-directional communication between a controller and attached RDM compliant devices over a standard DMX line. Users may set, monitor and manage the RDM supported devices and equipment in DMX network.

4-2 RDM Directory

RDM PID	Value	GET Allowed	SET Allowed
DISC_UNIQUE_BRANCH	0x0001		
DISC_MUTE	0x0002		
DISC_UN_MUTE	0x0003		
STATUS_MESSAGE	0x0030	O	
SUPPORTED_PARAMETERS	0x0050	O	
*PARAMETER_DESCRIPTION	0x0051	O	
DEVICE_INFO	0x0060	O	
PRODUCT_DETAIL_ID_LIST	0x0070	O	
DEVICE_MODEL_DESCRIPTION	0x0080	O	
MANUFACTURER_LABEL	0x0081	O	
DEVICE_LABEL	0x0082	O	O
LANGUAGE_CAPABILITIES	0x00A0	O	
LANGUAGE	0x00B0	O	O
SOFTWARE_VERSION_LABEL	0x00C0	O	
DMX_PERSONALITY	0x00E0	O	O
DMX_PERSONALITY_DESCRIPTION	0x00E1	O	
DMX_START_ADDRESS	0x00F0	O	O
SENSOR_DEFINITION	0x0200	O	
SENSOR_VALUE	0x0201	O	
DEVICE_HOURS	0x0400	O	
IDENTIFY_DEVICE	0x1000	O	O

Other important notes

- 5-1** A water collection tray is equipped at the rear of DNG-250. When the compressor is running for condensed fog, some water drops will flow into the tray. Please check the water level of the tray routinely and drain it on time to prevent overflow. (refer to figure 6).
- 5-2** If the machine is to be used for a long time or the water drops cannot be checked momentarily, the water collection tray can be removed and a 6 mm PU hose can be connected to the water draining hole located at the top of the water collection tank to directly drain out the water drops. After completing the draining, push up the upper red button to remove the hose. (refer to figure 7)



Figure 6

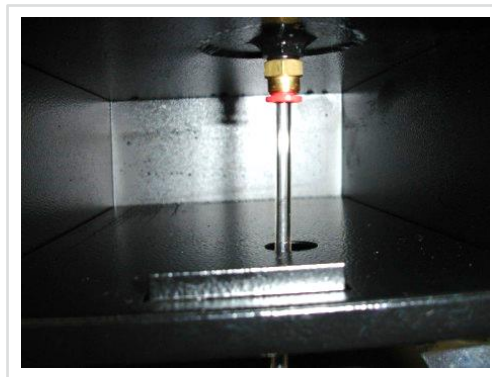

Figure 7

- 5-3** A black square metal mesh is located at the back of the machine. This is the air inlet of the fan. Please do not block the inlet and clean it routinely to keep the cleanness.
- 5-4** If the fog volume is too low, the machine generates noise during operation or the fog cannot be smoothly sprayed, please turn off the power immediately and check if the fog fluid is sufficient, whether the external fuse, controller connection or power supply has any problem. If none of the above shows any problem, insert the power plug again. If the machine still cannot normally operate, please check whether the hose connecting to the fog fluid tank is blocked, and if any fluid is flowing. If the cause cannot be identified, please do not allow the machine to operate to avoid damage. Turn off the machine Immediately and let it cool down. Please contact an Antari dealer or a designated service center. Do not disassemble the machine by yourself.
- 5-5** After using the DNG-250 for a long time, there may be residue on the floor which could be a possible cause of danger. Please note the material of the floor and pay special attention to the safety of persons walking on it.
- 5-6** The DNG-250 Low Fog Generator does not use dry ice. It is very environmental friendly and safe. However, the output fog is easily to be blown away by wind. Please note the air flow's impact from fan or air conditioner.

Maintenance of the Machine

- 6-1** Cleaning your fog machine regularly will help reduce costly replacement and repair charges.
- 6-2** Do not allow the fog fluid to become contaminated. The cap should be on the tank at all times.

- 6-3** Prior to storing the machine for a longer period, clean it and drain all fog fluid from the tank. Disconnect and store the fog pipe and power cord. Store the machine and all parts into the parts tank located at front of the machine. Warm up the machine once a month, to protect it from moisture.
- 6-4** Store the machine cool and dry.

Technical Specifications

- Input voltage	EU model: AC 220-240V, 50 / 60Hz 3.8~6.5A
- Refrigerant	R-404A , 1.76lb (0.8 kg)
- Start current	240V / 36.1A
- Rated power	240V / 1600W
- Warm-up time	240V / 8 mins (approx.)
- Fluid consumption	100 ml / min (100% output)
- Fluid tank capacity	10L (2.64gal)
- Compatible fluid	Antari FLL-10 Low Fog Fluid
- Ambient temp. range	5°C ~ 40°C (41°F ~ 104°F)
- Output	120 m ² / min
- Control	Manual and Timer Mode DMX 512
- DMX Channels	1 channel
- Optional Accessories	FDNG-250 Flight Case
- Dimensions	L 780 W 608 H 715 mm
- Weight	130 kgs (286.60 lbs)

Please save this user manual carefully

DNG-250 LOW FOG GENERATOR

恭喜您擁有了這部全新的 Antari DNG-250 低煙機

感謝您選擇了 Antari DNG-250 低煙機，這部機器除了以往 Antari DNG-200 基本的煙霧冷卻功能外，我們增加了全新的功能，使用 3.5 吋觸碰式全彩 TFT-LCD，讓使用者在操控上更簡單方便，機器大小體積跟 Antari DNG-200 一樣，但是煙霧的輸出量及持續能力都有全面性的提高，效果相較過去的 Antari DNG-200 有顯著的提升，讓舞台空間的動線運用及表演的效果都可以更加完美。Antari DNG-250 低煙機不使用二氧化碳，所以不會對環境及人體造成負擔，同時具有完美低霧特效及兼具環保，是一款真正的綠色特效機器。

為確保您機器的使用及輸出效果的完美，在操作機器前，請詳細閱讀這份使用說明書，請按照說明書內的內容操作以及維護，並注意安全說明事項，以確保 DNG-250 低煙機使用壽命可以更加延長以及操作人員能更加安全的使用機器。

請注意印在 ANTARI 機器外部的所有警告標籤和說明。

注意事項

- 請保持機器乾燥。
- 機器設計在室內使用，請勿在戶外使用本機器。
- 理想的機器操作溫度，在室溫攝氏 5 度 ~ 40 度之間。
- 這部機器使用兩組專業用電源線，在安裝好插頭要連結電源供應前，請確認您使用的電壓並使用接地型插座以避免觸電的危險。
- 在上下搬運或運送過機器後，需將機器靜置 1 小時，讓冷卻器中的冷媒平穩後，再開始操作機器。
- 若是水平的移動機器，請於機器安置定位後，靜置 5 分鐘再開始操作。
- 拔開機器和 AC 電源插座時，請確認機器已關機不在使用的狀態下。
- 本機器並未做防水設計，請勿將機器暴露在雨中或潮濕的環境，如果有液體(煙霧油)翻倒或溢出的現象，請勿連結機器與 AC 電源，如在使用中請先關掉電源並移除 AC 電源線，並將機器擦拭乾淨後，再重新開啟電源，如果液體進入機器內部，無法清除，請連繫 Antari 的代理商。
- 本機器不含任何拆解和自行維修或修改的零件在內，請勿嘗試自行維修或改裝機器，未經授權的技術人員，可能導致機器故障或永久損壞，遇有機器問題時，請連繫 Antari 代理商。
- 機器限成人操作，請勿讓機器在沒有工作人員的情況下單獨運轉。
- 請將機器置放於通風良好的地方，不要在機器上方堆積或覆蓋物品，最好保留機器四周邊有一公尺以上的空間。
- 請勿將機器安置在傾斜的斜坡上，以免機器滑動。
- 請勿添加任何易燃物品進入機器。
- 操作機器時請確認週邊沒有任何易燃材料。

- 如果您的 DNG-250 出現工作異常，請先關閉電源開關，靜置 5 分鐘後，重新開啟電源，若異常現象仍然存在，請聯繫 Antari 代理商。
- 在清潔或保養您的機器前，請確認機器的電源已經關閉，並且機器溫度已經冷卻。
- 為確保機器的使用壽命，請使用 Antari FLL 低煙機煙霧水，添加其他液體可能會導致機器故障
- 如果機器出現故障，請移除機器插頭，立即停止工作，並請連繫您當地的 Antari 經銷商。
- 運送機器以前，請確認機器的油箱已完全清空。
- 煙霧油不能食用，吞食煙霧油可能導致損壞健康的風險，請將煙霧油存放在室內安全的地方，如果碰觸到眼睛或誤食，請立即尋求醫生協助。

打開包裝及檢視機器

在收到機器，請立即小心地打開包裝紙箱，檢查所有內容，以確保所有零配件都有齊全收到，並處於良好的狀態，如果有任何部件因運輸過程出現損壞或缺少，請立即連絡經銷商，並以原包裝退回檢查，機器出廠時包含的物件有：

- 1 台 DNG-250 低煙機
- 2 條 Neutrik Powercon 接頭的電源線
- 1 條 黑色煙霧導管 3 公尺
- 1 本 使用說明書 (2 - 4 項放置在機器前上方的儲存盒中)
- 1 個 集水盤 (已安裝在機器上)
- 1 條 6 mm PU 管 3 公尺

安裝機器的步驟

步驟 1：DNG-250 底部的輪子可以協助移動，對角線上的輪子置有固定器，將機器放置在定點，壓下固定器以固定機器避免滑動(參考圖一)，需要移動機器時，只要在反方向壓下將固定器鬆開即可移動器。(機器週圍至少保持 1 公尺以上的空間)

注意!由於機器體積龐大，請勿將機器固定於斜坡上。



圖一

步驟 2：將電源線帶有 Powercon 的一端連結機器(請確認電源開關在關閉/OFF 的情況下)，請將卡榫對準機器連接座凹槽，插入後順時針旋轉約 10 度(參考圖二)，將電源線完全固定為止。兩條電源線都

需要照此步驟安裝好，上方的電源線是供應煙霧機的電源，下方的電源是供應壓縮機的電源。(參考圖二、三)

- 將機器連接電源之前，請確認機器上技術銘版上標示所需的電壓及功率，是否與電源相符。

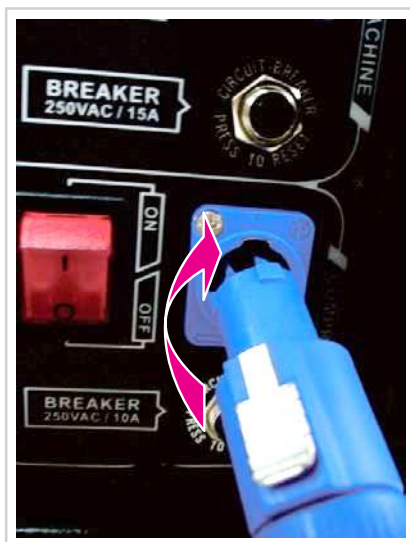

圖二



圖三

步驟 3：結合機器與黑色煙霧導管，此煙霧導管長度為三米，可依照實際需要長度伸縮使用。(參考圖四)

步驟 4：倒入 Antari FLL 低煙機煙霧水至機器上的油桶中，並旋緊油桶蓋。(參考圖五)



圖四



圖五

操作說明

1. 確認電壓後，將機器電源線連接至有接地的插座上，機器背後有兩組紅色的電源開關，請先啟動下方的壓縮器電源，再啟動上方煙霧機電源，開始溫機。此時 TFT-LCD 上方會先顯示目前電熱管溫度百分比，到達 100% 為加熱完成。



2. TFT-LCD 操控方式

2-1 主畫面介紹

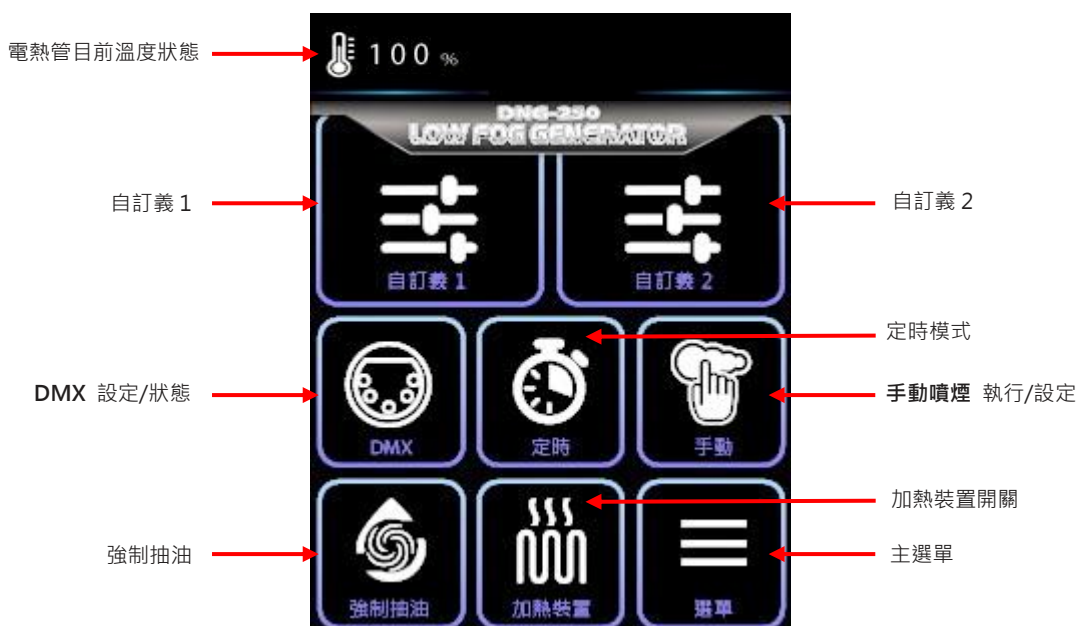

2-2 手動：手動噴煙功能鍵



2-2-1 手動噴煙配置選單



2-3  定時：定時噴煙功能鍵



2-3-1  定時模式配置選單



2-4  DMX：DMX 功能鍵為目前 DMX 狀態及設定選項

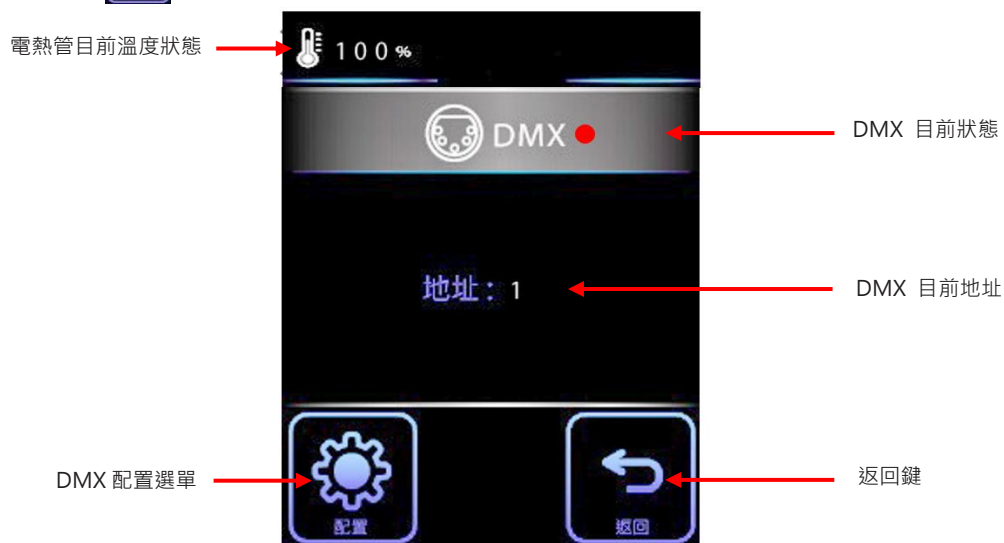

2-4-1 DMX 模式配置選單



DMX 地址設定，直接輸入要的地址數字，按下右下方確認即可。

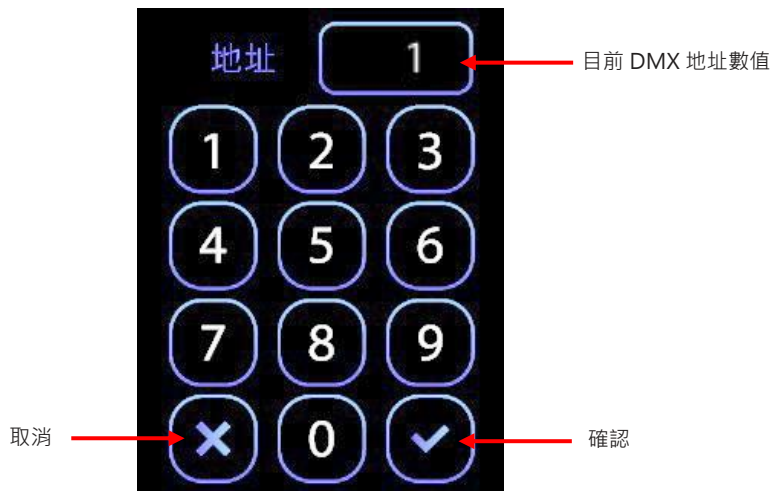

2-5 強制抽油：當油幫浦空油時不易抽到煙霧油時，可使用此一功能抽油，當煙霧從機器出來時請按下暫停鍵以防止煙霧過於潮溼。(預設時間為 1 分鐘)

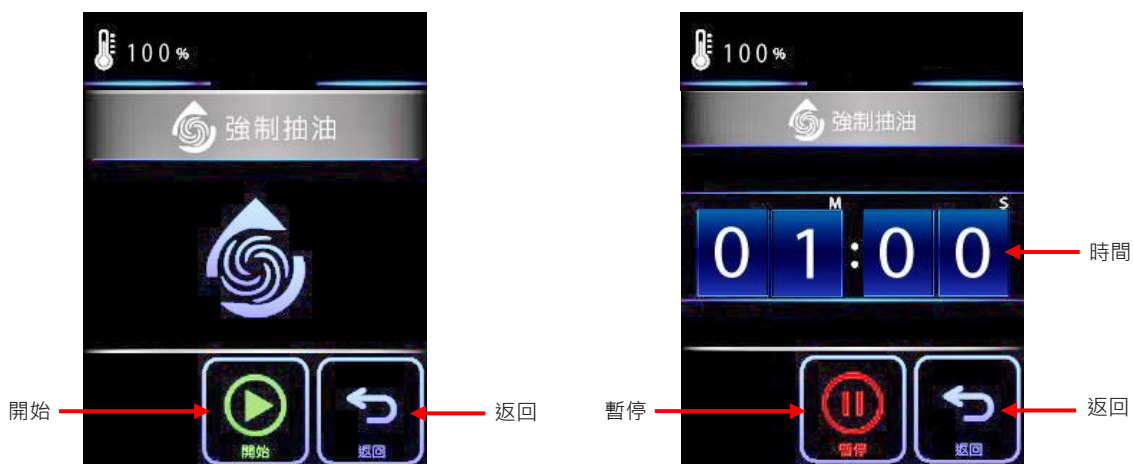

2-6  加熱裝置：手動控制啟動/關閉電熱管是否加熱。機器預設值為電源一打開自動啟動加熱。

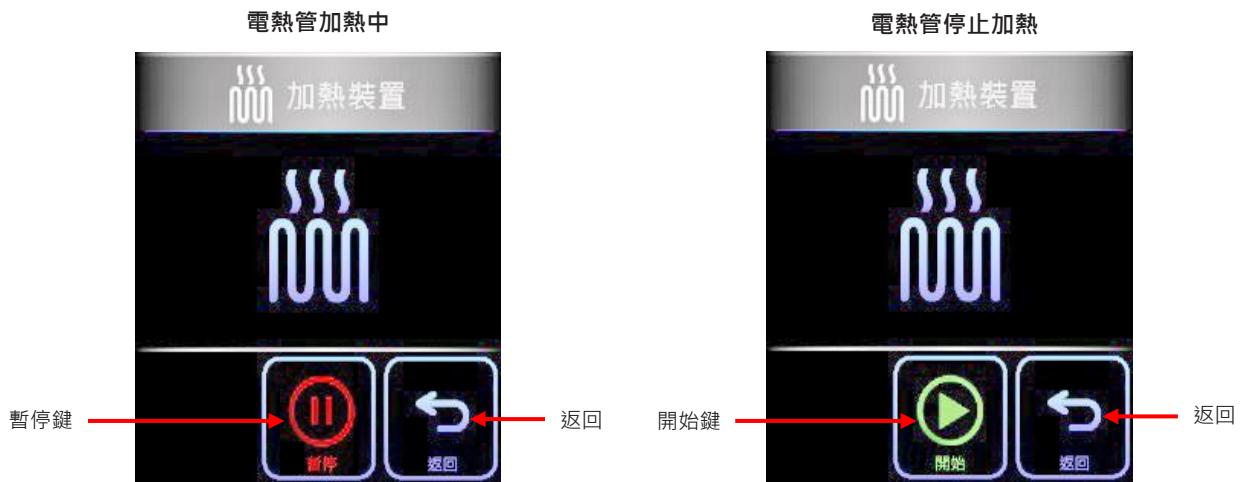

2-7  主選單：DNG-250 功能選單

- | | | |
|-------|---|--|
| 2-7-1 |  DMX 設定 | DMX 設定選單 |
| |  地址 | DMX 地址設定，請參考 DMX 設定頁面說明 |
| 2-7-2 |  資訊 | 機器基本資訊選項 |
| |  軟體版本 | 目前機器軟體版本 |
| |  溫度 | 目前機器溫度單位 |
| |  工作電壓設定 | 目前工作電壓設定 |
| |  使用時間 | 本次機器開機時間 |
| 2-7-3 |  設定 | |
| |  LCD 背光 | LCD 亮度有 低 / 中 / 高 / 自動關閉 四種模式，自動關閉為分鐘後無任何操作時，螢幕會自動關閉 |
| |  自動啟動 | 此模式為開機加熱完成後，自動執行關機前動作 |
| |  恢復原廠設定 | 恢復出廠時設定 |



中文 / 英文



機器軟體更新 (僅提供給 Antari 經銷商作服務)

DMX 說明

3-1 連接 PIN 的接點說明

本機器提供 3 PIN 及 5PIN XLR 的 DMX 連接，下方為 Pin 接點說明：

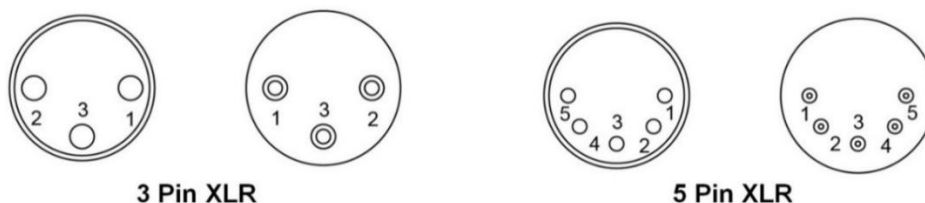

Pin	功能
1	接地
2	數據 -
3	數據 +

3-2 DNG-250 DMX 說明

DNG-250 低煙機已有內建 DMX 512 功能，並設有 3PIN 及 5PIN 二組公母頭連接座可供選擇使用，連接 DMX 之後 DNG-250 最多只使用一個控制頻道，此時 DNG-250 的動作控制都將由 DMX 控台所控制，TFT-LCD 在 DMX 模式下無法控制機台動作，只能設定 DMX 相關數值。

3-3 DMX 數值說明

功能	數值	說明
煙量	0 - 4	關閉
	5 - 255	1 - 100%

RDM 功能

4-1 RDM 功能說明

DNG-250 配有 RDM 的功能，讓使用者可以透過 RDM ANSI E1.20 協議的設備進行控制，這是一種利用 DMX 通道來達成雙向通信的功能。可以透過 RDM 功能來設定、監控、管理在 DMX 網路中有支援的 RDM 設備及裝置。

4-2 RDM 指令表

RDM PID	Value	GET Allowed	SET Allowed
DISC_UNIQUE_BRANCH	0x0001		
DISC_MUTE	0x0002		
DISC_UN_MUTE	0x0003		
STATUS_MESSAGE	0x0030	O	
SUPPORTED_PARAMETERS	0x0050	O	
*PARAMETER_DESCRIPTION	0x0051	O	
DEVICE_INFO	0x0060	O	
PRODUCT_DETAIL_ID_LIST	0x0070	O	
DEVICE_MODEL_DESCRIPTION	0x0080	O	
MANUFACTURER_LABEL	0x0081	O	
DEVICE_LABEL	0x0082	O	O
LANGUAGE_CAPABILITIES	0x00A0	O	
LANGUAGE	0x00B0	O	O
SOFTWARE_VERSION_LABEL	0x00C0	O	
DMX_PERSONALITY	0x00E0	O	O
DMX_PERSONALITY_DESCRIPTION	0x00E1	O	
DMX_START_ADDRESS	0x00F0	O	O
SENSOR_DEFINITION	0x0200	O	
SENSOR_VALUE	0x0201	O	
DEVICE_HOURS	0x0400	O	
IDENTIFY_DEVICE	0x1000	O	O

其它重要注意事項

- 5-1 DNG-250 後方設有集水盤，當壓縮機運轉凝煙霧時，會有些許水滴流入集水盤，請注意集水盤的水量是否滿溢，並適時傾到。(參考圖六)如需要長時間使用機器或無法隨時注意集水盤狀況時，可以取下集水盤，將一條 6mm 的 PU 管，連結機器集水槽上方的排水孔(參考圖七)由水管直接將水導流出，用完後只需將上方紅色按鈕往上推，即可退出排水管。



圖六

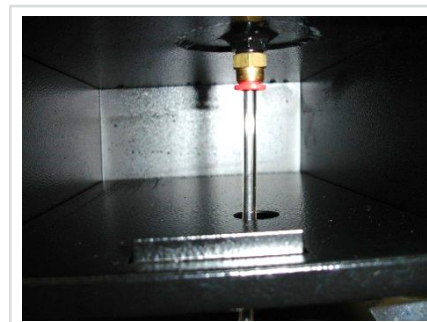

圖七

- 5-3 機器後方有黑色四方型金屬網片，此為風扇進氣口，請勿遮擋住，並定期清潔，保持乾淨。
- 5-4 倘若發生煙霧量過少、機器運轉時產生噪音或無法順暢噴煙動作時，請立即關閉電源，檢查是否有足夠的煙霧油，連結煙霧油桶的管子是否通暢，有無液體流通，以上皆無問題，再開啟電源。持續無法正常運作，若無法辨識原因，請勿繼續讓機器運轉，以免損壞機器，應立即關機冷卻，並連絡 Antari 代理商，請勿自行拆卸。
- 5-5 DNG-250 的特性是讓煙霧輸出後貼地而行，在長時間使用後，地面會因為水汽而產生濕滑，請注意地面材質，並請特別注意在上面行走或表演者的安全。
- 5-6 DNG-250 是一種不使用乾冰的低煙特效機器，非常的環保及安全，但輸出的煙霧較易被風吹散，請在使用時，注意風扇或空調對效果的影響。

機器的維護保養方式

- 6-1 請定期清潔您的 DNG-250 低煙機，將可有效的協助您降低零件更換率或維修費用。
- 6-2 請注意勿使用被污染煙霧水，隨時蓋上油桶的瓶蓋，及煙霧機上所裝置煙霧油桶的蓋子。
- 6-3 在機器不使用需收起來之前，請先清潔機器並確定將油桶清空，並拆下煙導管與電源線收好，整套機器與配件請存放於機器前方配件槽中，每月固定溫機一次，可保護機器較不受潮。
- 6-4 請將放置機器於陰涼處

技術規格

- 電壓 歐規: AC 220-240V, 50 / 60Hz 3.8~6.5A
- 冷煤 R-404A · 1.76lb (0.8 kg)
- 啟動電流 240V / 36.1A
- 電熱管功率 240V / 1600W
- 首次加熱時間 (約) 240V / 8 分鐘
- 耗油量 100 毫升 / 分鐘 (100%)
- 油桶容量 10L (2.64gal)
- 適用煙霧水 Antari FLL-10 低煙機專用煙霧水
- 適用環溫 5°C ~ 40°C (41°F ~ 104°F)
- 輸出量 120 m² / min
- 控制方式 定額模式 與 定時模式
- DMX 512 頻道 占用 1 頻道
- 選擇性配件 FDNG-250 飛行箱
- 尺寸 長 780 寬 608 高 715 mm
- 重量 130 公斤 (286.60 磅)

請妥善保存本使用說明書



For current product information visit Antari at:

www.antari.com / www.antari.com.tw

For information requests please contact us at:

sales@antari.com

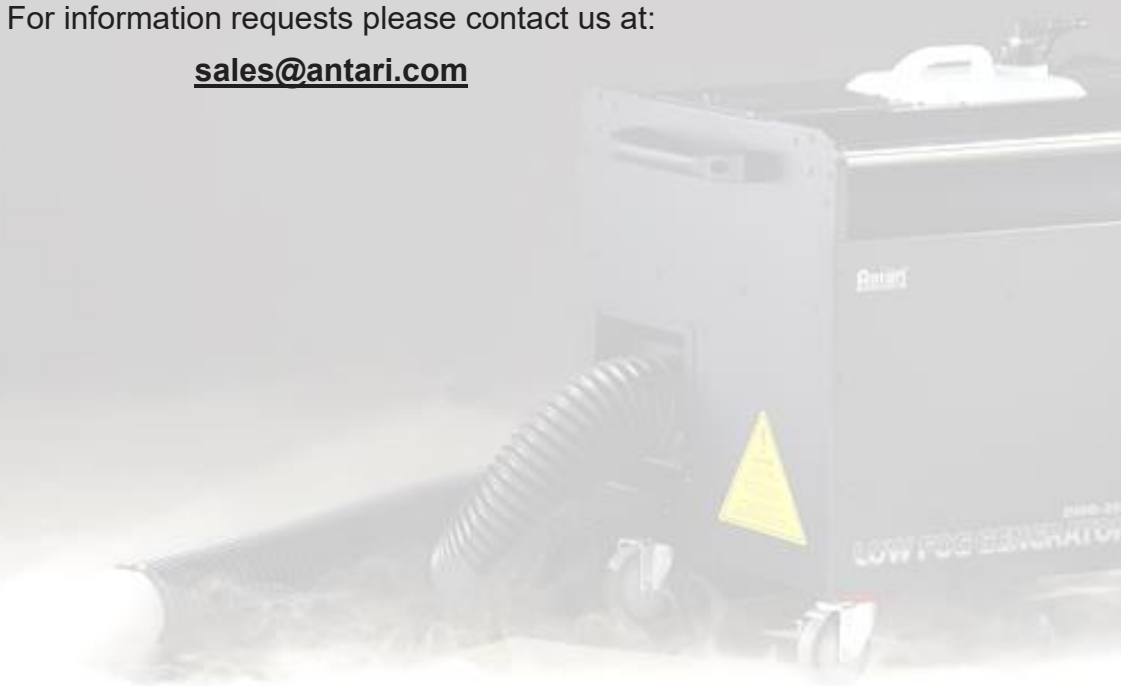

C08DNG251