

ACCESSORIES

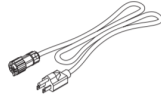

Rope Ratchet



AC Power Cord

Optional:



Dimming Cord

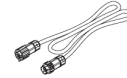

AC Connection Cord



Dimming Connection Cord

INSTRUCTIONS

1) Hang the rope ratchets on the tent pole or mounting surface.

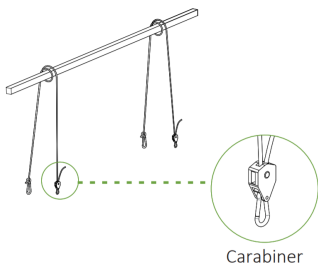

2) Pull the rope to adjust the fixture up or press the lock to release and lower down the fixture.

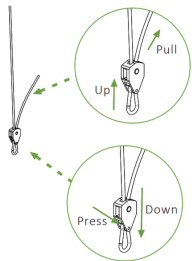

3) Open the folded light.

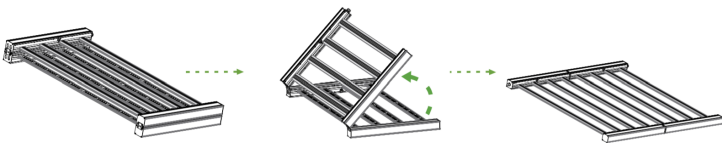

4) Clip the carabiners into the rings on the light.

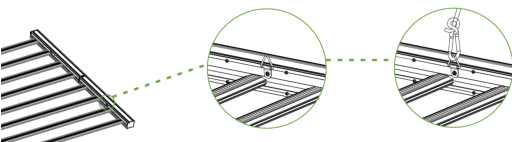

5) Assembly complete.

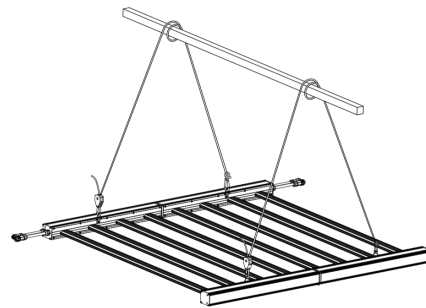

To connect the power cord, align the terminals of the cord, plug in and twist to secure.



To disconnect the power cord, twist the two halves away from each other first, then pull apart.

Warning

