



Welcome to the *Hidrate Spark 3* Quick Start Guide.

Breathe easy—we've made it short and simple. Let's do this!

In your box, you should have:

- A. Lid
- B. Soft Grip Body
- C. Sensor Stick

- D. Finger Loop
- E. Battery
- F. Bottom Ring

A

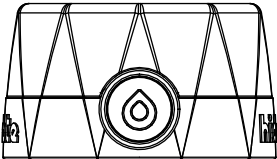

B

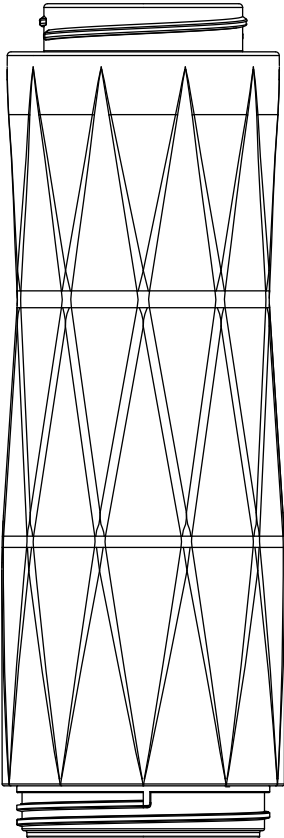

C

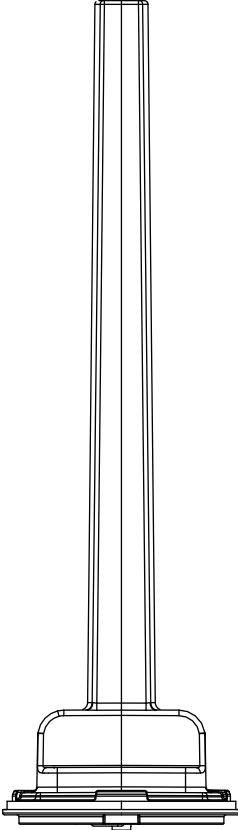

D

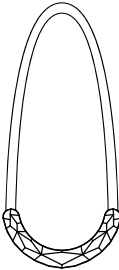

E



F

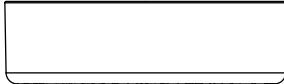

PARTS USED IN STEP:

B. Soft Grip Body

C. Sensor

F. Bottom Ring

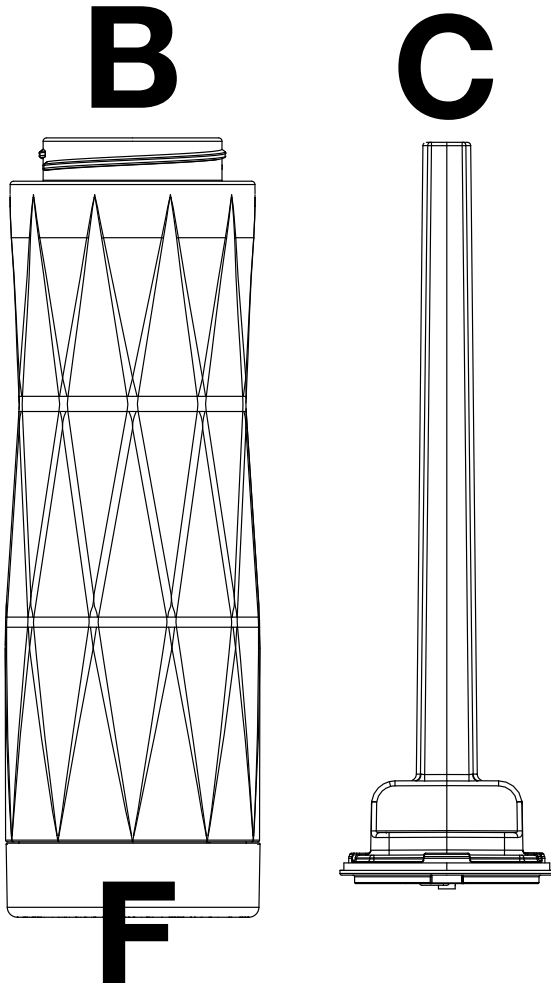

STEP 1:

Turn bottle upside down and unscrew the battery cover from the base of the bottle.

turn right – tighten

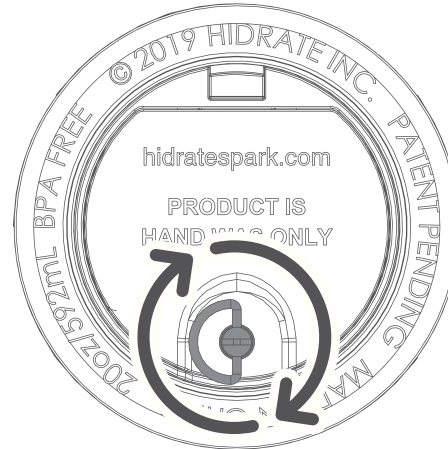

turn left – loosen



PARTS USED IN STEP:

E. Battery

F. Bottom Ring

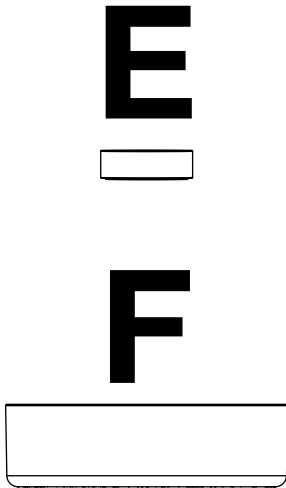

STEP 2:

Once the battery cover is removed insert battery into sensor.

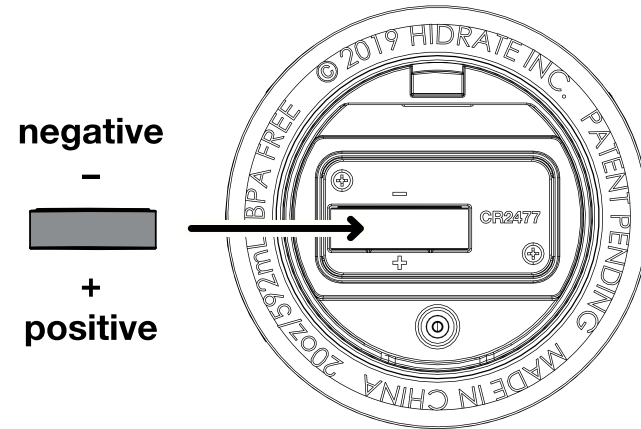

The sensor will illuminate with a startup sequence.

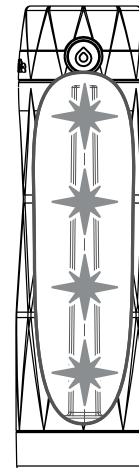

PARTS USED IN STEP:

B. Soft Grip Body

C. Sensor Stick

F. Bottom Ring

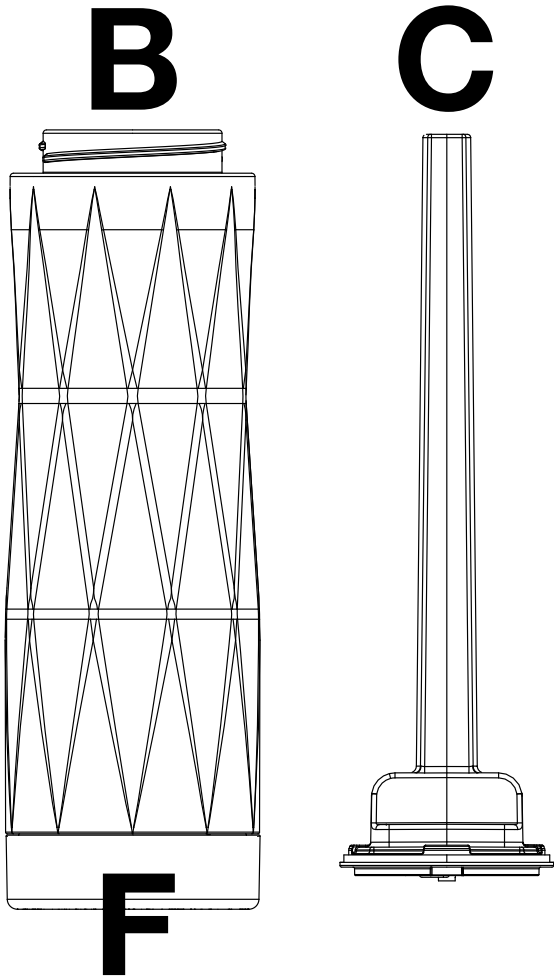

STEP 3:

Lastly, secure battery cover back on base of bottle. DO NOT overtighten the screw when reassembling. Overtightening may cause damage to the product.

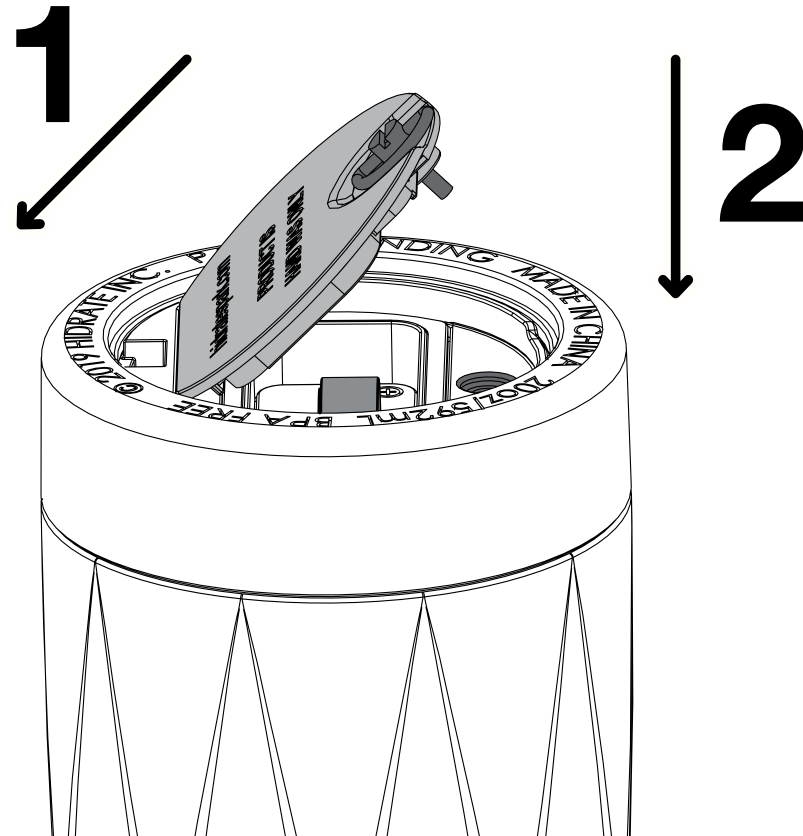

PARTS USED IN STEP:

A. Lid

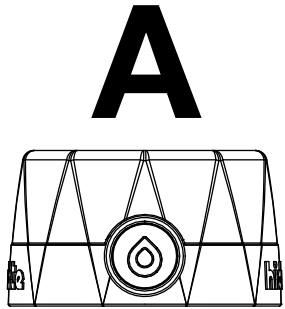

STEP 4:

Make sure the arrow on the seal and on the inside of the lid are facing the same direction to prevent leakage.

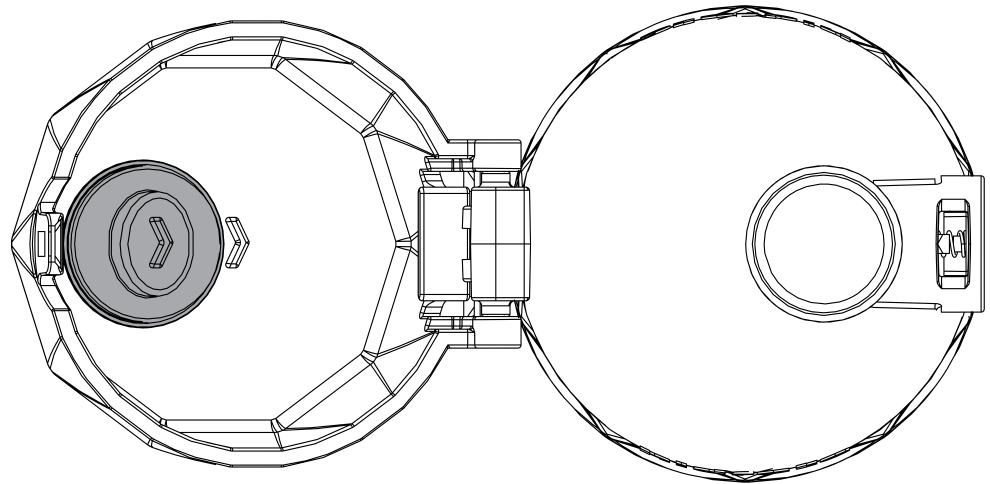

PARTS USED IN STEP:

A. Lid

D. Finger Loop

A

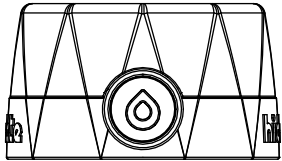

D

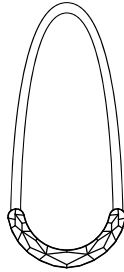

STEP 5:

To attach the finger loop, slide it underneath the metal pin on the back of the lid and loop it through itself.

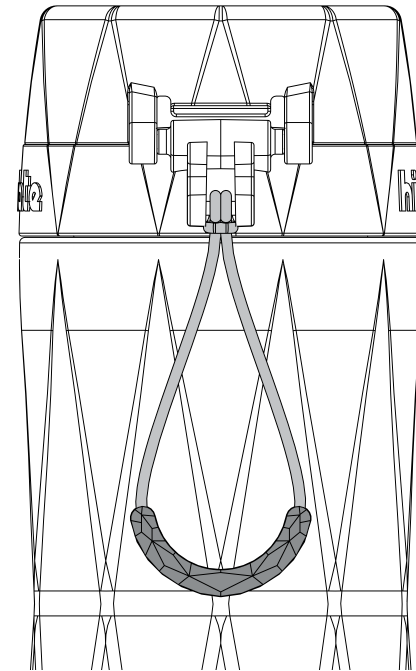
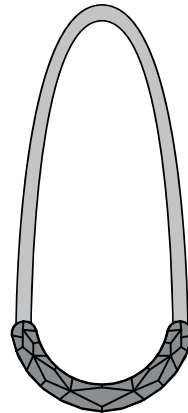

PARTS USED IN STEP:

Mobile Phone

Hidrate Spark
Smart Bottle App

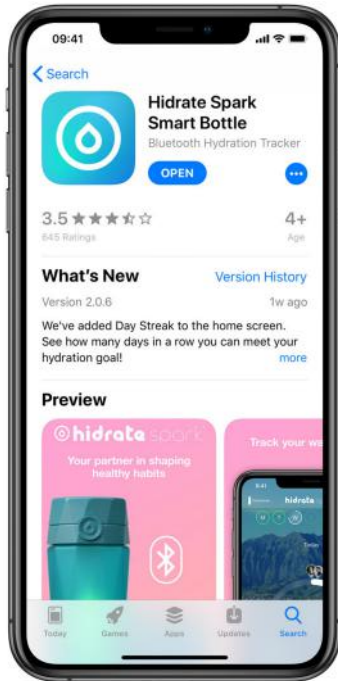

STEP 6:

Download our free Hidrate Spark Smart Water Bottle app from the App Store or Google Play store.

Check that you have an internet connection and your Bluetooth is turned on. Follow the steps in the app to create an account, set parameters for a personalized hydration goal, add your bottle to your profile, and set your push notifications and glow reminders.



PARTS USED IN STEP:

You!

Hidrate Spark 3

Hidrate Spark Smart
Water Bottle App

STEP 7: last step

Set down your bottle after every refill. Remember to sync the app near the bottle each day so your water is tracked correctly.

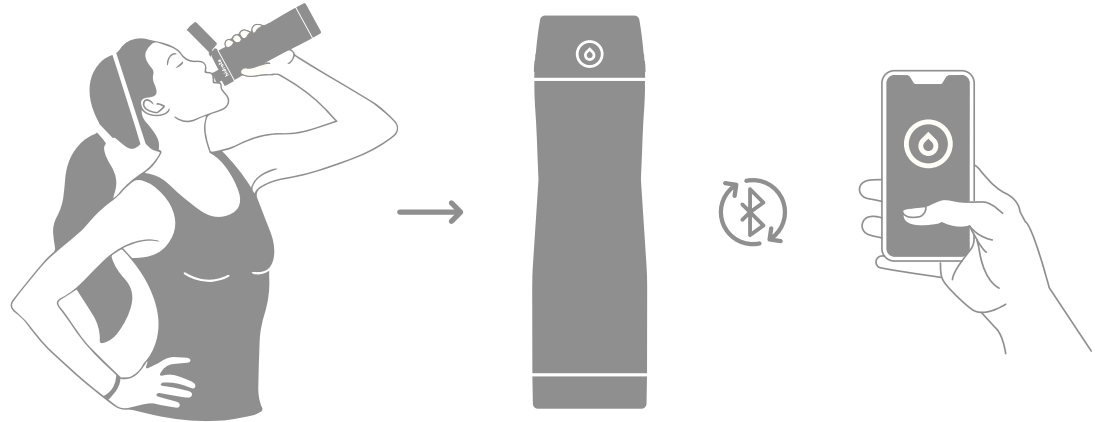

PARTS USED IN STEP:

A. Lid

B. Soft Grip Body

A

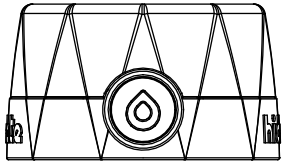

B

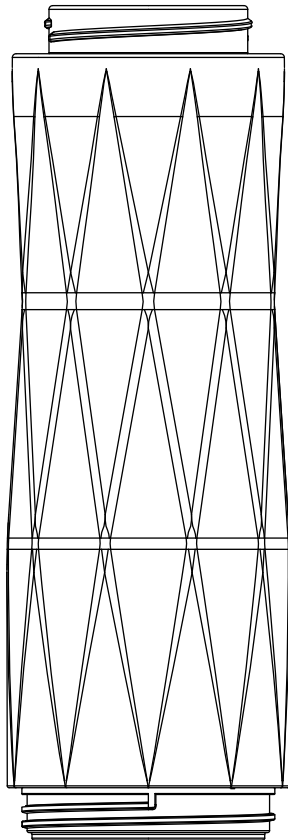

CLEANING INSTRUCTIONS

Wash thoroughly before first use.

RINSE IMMEDIATELY AFTER EACH USE with the lid in the open position.

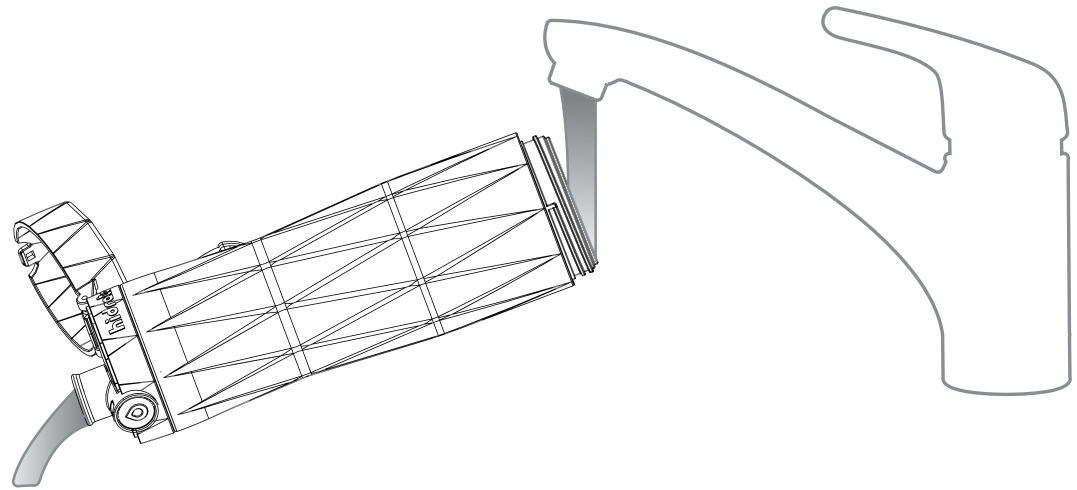

PARTS USED IN STEP:

A. Lid

F. Bottom Ring

A

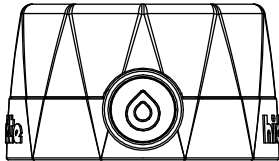

F

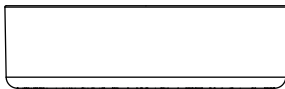

CLEANING INSTRUCTIONS

Lid and Bottom Ring are Top-Rack dishwasher safe.

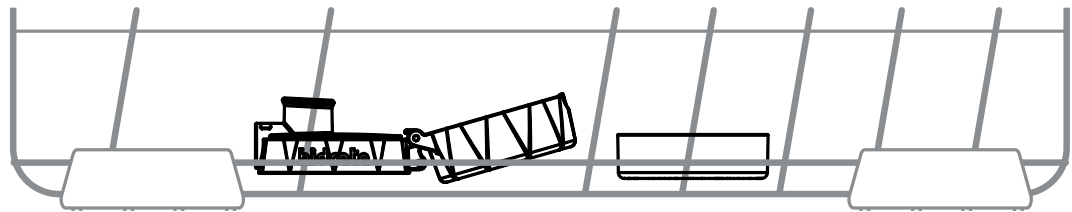

PARTS USED IN STEP:

B. Soft Grip Body

C. Sensor Stick

B

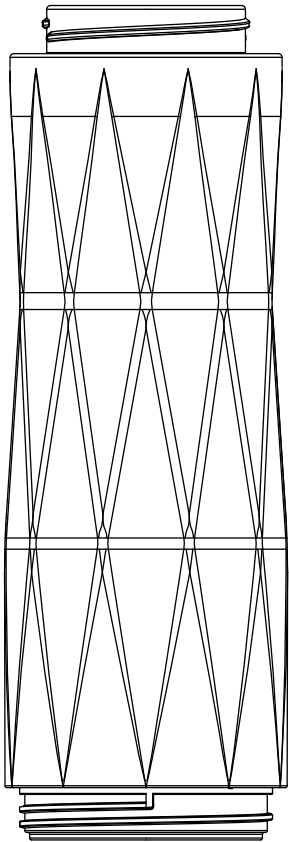

C

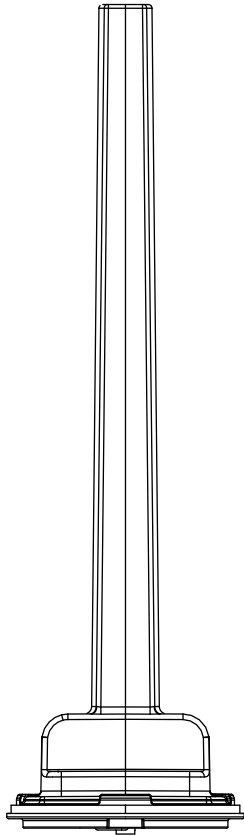

CLEANING INSTRUCTIONS

The Sensor Stick and Body of the bottle are **HAND WASH ONLY**.

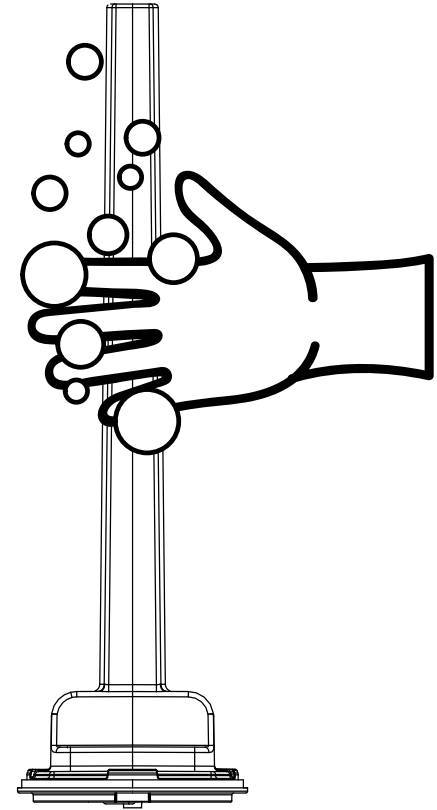
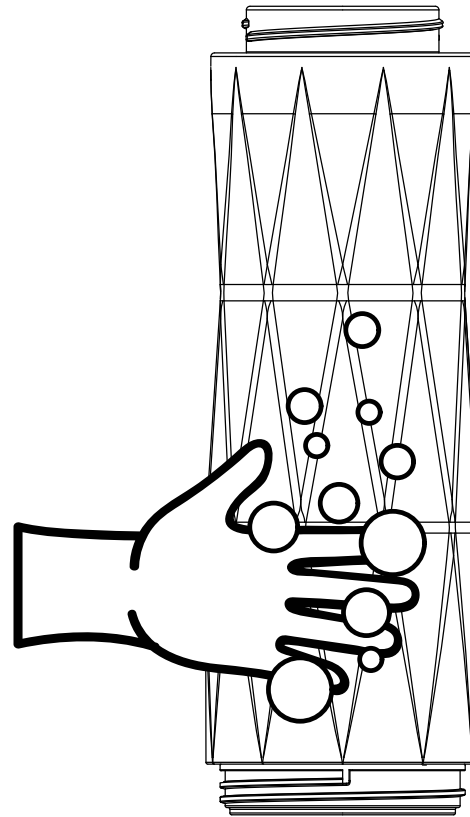

PARTS USED IN STEP:

- A.** Lid
- B.** Soft Grip Body
- C.** Sensor Stick
- F.** Bottom Ring

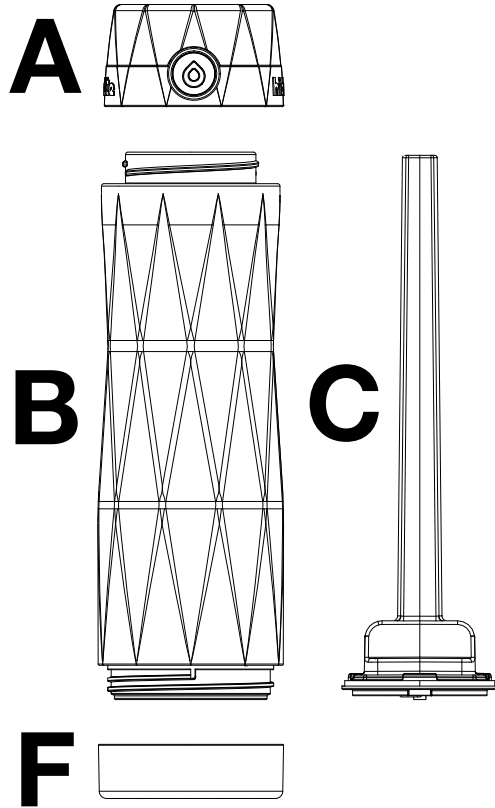

CLEANING INSTRUCTIONS

ALWAYS STORE BOTTLE WITH LID, BOTTOM RING and SENSOR STICK REMOVED to allow parts to dry completely.

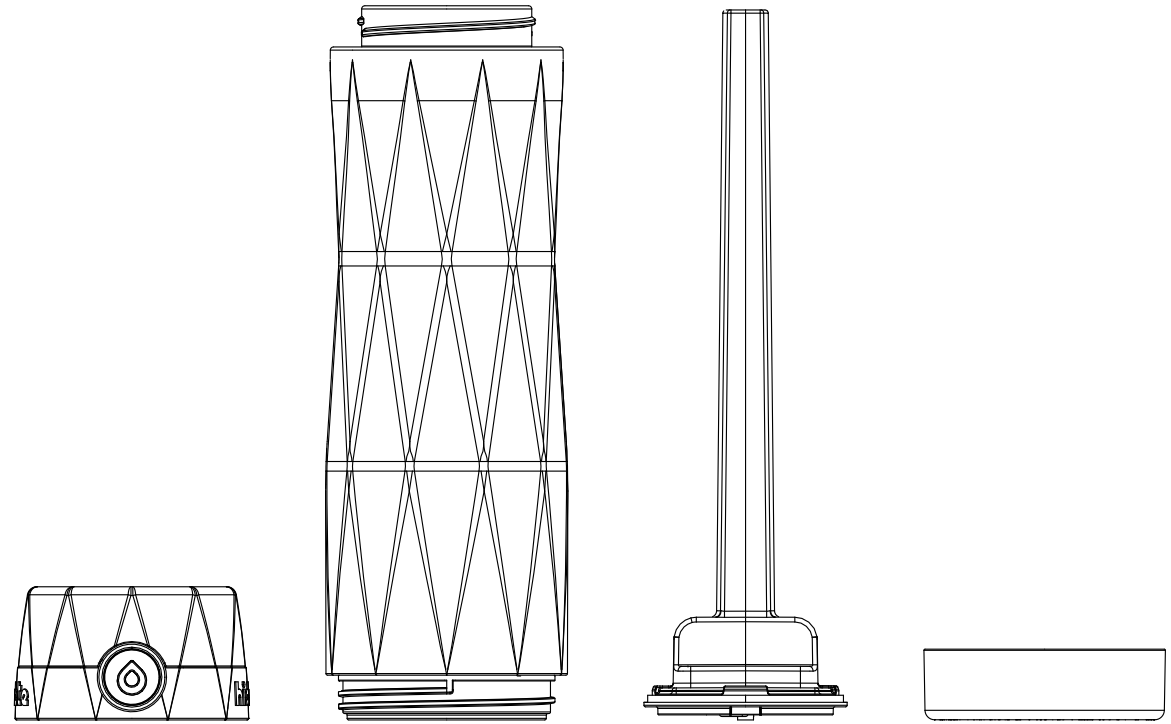

ATTENTION:



- Your Hidrate Spark bottle uses one CR2477 Lithium battery. During the battery replacement process these batteries represent choking hazard.
- Product is NOT designed for hot liquids. Use only with cold liquids.
- Adding ice can cause an inaccurate measurement.
- Not for use with carbonated or pulpy beverages.
- Prior to drinking, make sure the lid is properly threaded to the body and screwed on completely.
- DO NOT overfill. Fill liquids to the fill line or below to avoid accidental spilling.
- DO NOT microwave or freeze.
- DO NOT use cleaners containing bleach, chlorine, abrasives and/or harsh chemicals.
- DO NOT continue to use if product is damaged.
- DO NOT carry bottles containing liquid in bags to help prevent accidental opening.

CONTACT AND MORE

We're here to support you.
If you ever need to contact us, here's how:

Chat with us on our website

hydratespark.com

Email

support@hydrate.me

In App

Settings > Help

For more information and best practices,
please visit hydratespark.com/pages/guide
to review the user manual.