

CANDEO

Kirkasvalolaite • Bright Light Therapy Lamp • Lampe de Luminothérapie •
 Lichtbak voor lichttherapie • Lichttherapielampe • Ljusterapiarmatur •
 Ereda Valguse Teraapia Lamp • Lampade per Luminoterapia •
 Лампа для терапии ярким светом

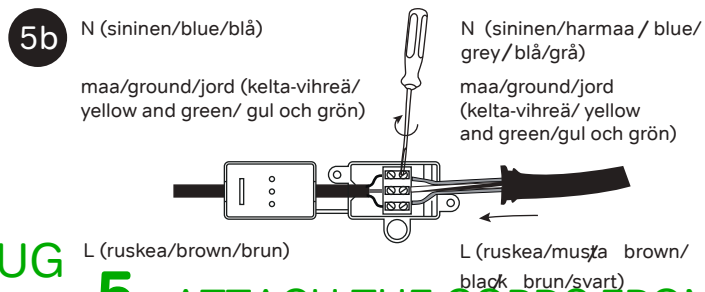

CONTINUE HERE ACCORDING TO THE INSTRUCTIONS

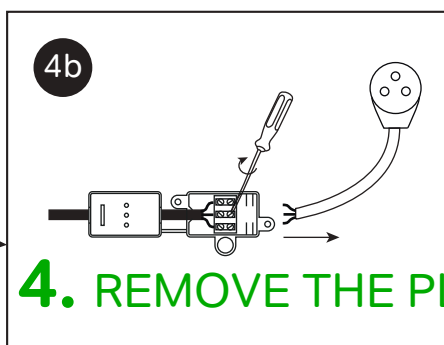
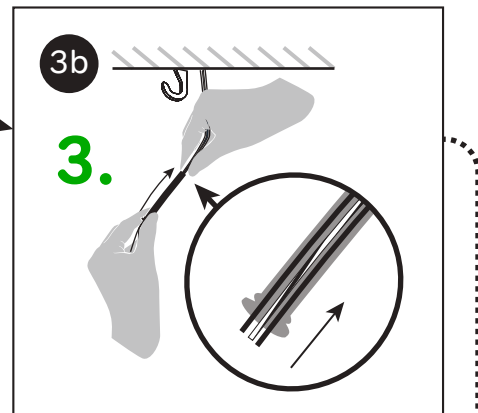
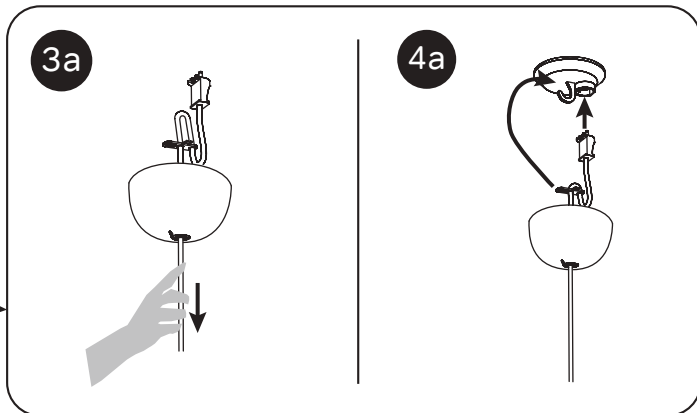
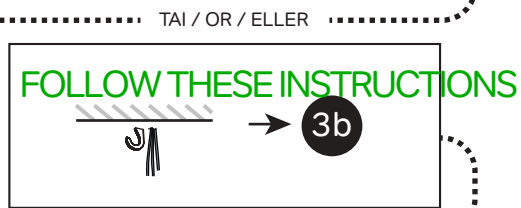
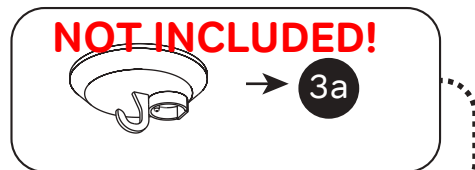
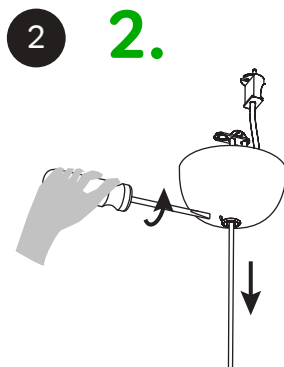
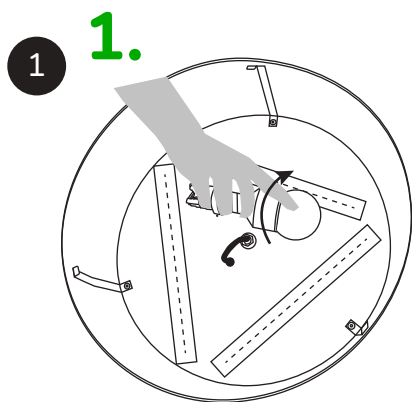
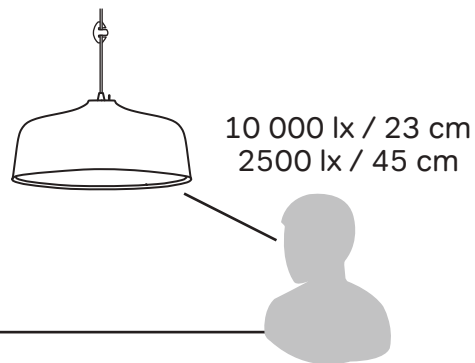
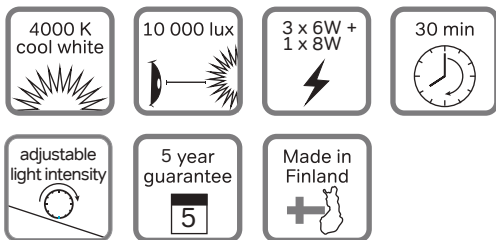
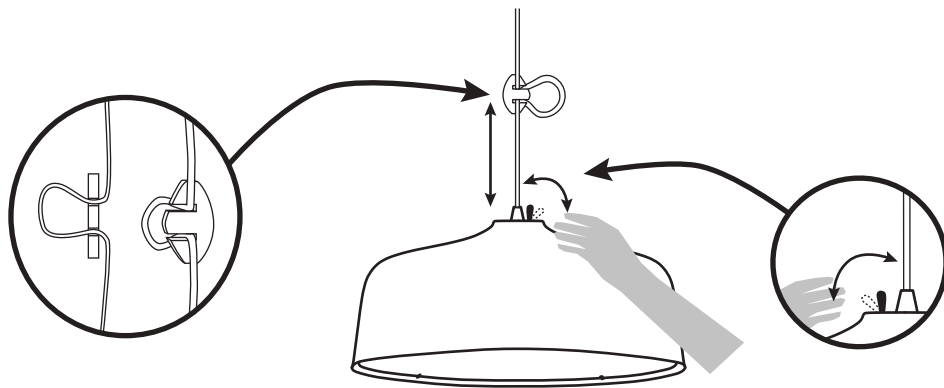
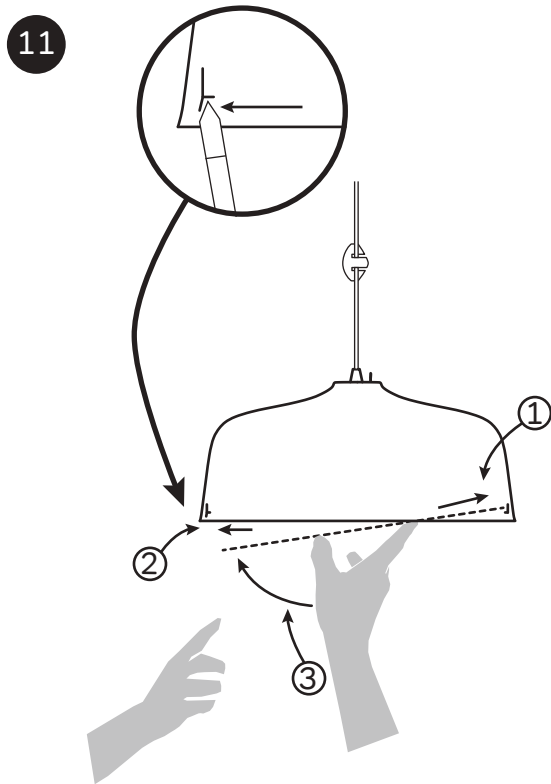
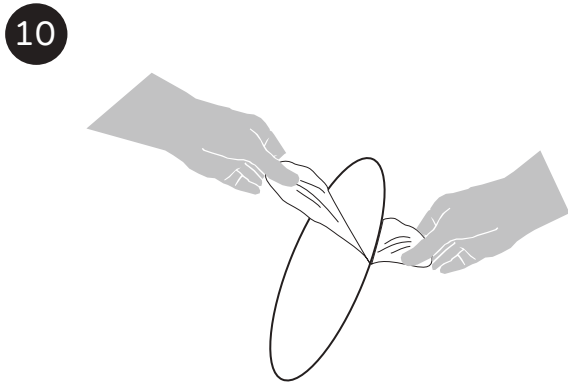
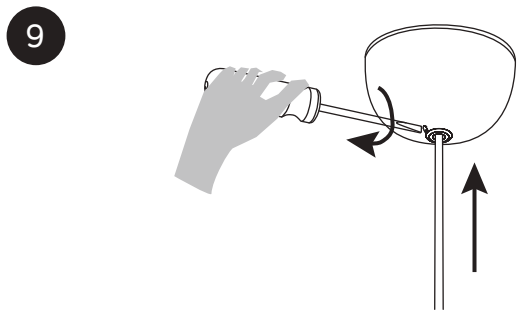
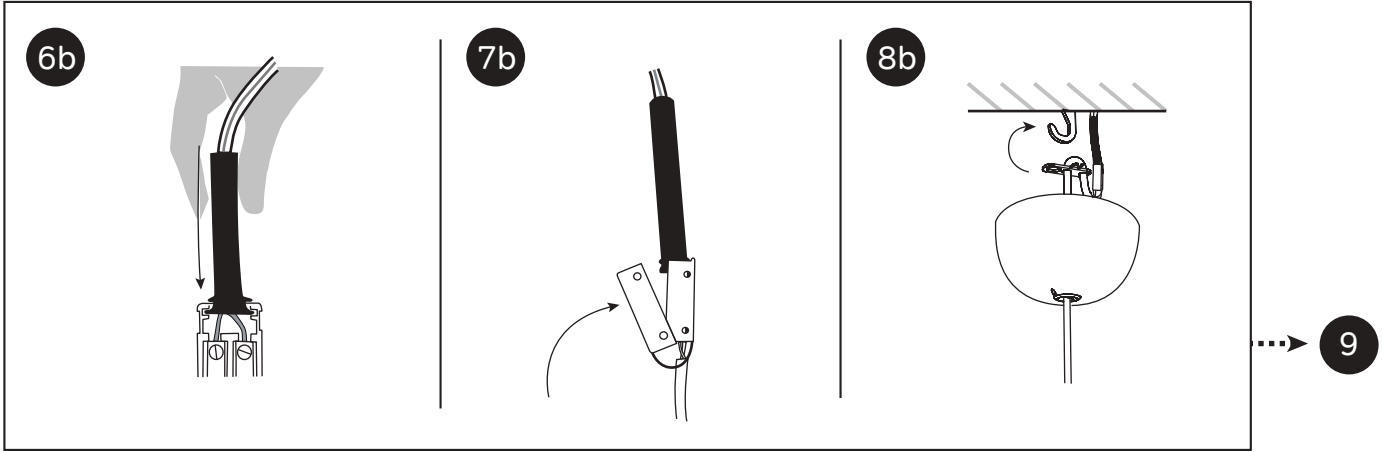

HUOM! LED valonlähteet saa vaihtaa vain sähköalan ammattilainen. Jos valonlähteet ovat vioittuneet, ota yhteyttä sähköalan ammattilaiseen, jälleenmyyjään tai valmistajaan.

NOTICE! LED light sources must be replaced by professional electricians only. If the light sources have been damaged, contact a professional electrician, retailer, or manufacturer

OBS! LED-ljuskällor får enbart bytas ut av elektriker. Om ljuskällan har skadats, kontakta en elektriker, återförsäljaren eller tillverkaren.