

beurer

LR 210



DE Luftreiniger Gebrauchsanweisung	2	IT Depuratore d'aria Istruzioni per l'uso	42
EN Air purifier Instructions for use	12	TR Hava temizleyici Kullanım kılavuzu	52
FR Purificateur d'air Mode d'emploi	22	RU Воздухоочиститель Инструкция по применению	62
ES Purificador de aire Instrucciones de uso	32	PL Oczyszczacz powietrza Instrukcja obsługi	72

CE



Read these instructions for use carefully and keep them for later use, be sure to make them accessible to other users and observe the information they contain.



WARNING

- This device may be used by children over the age of eight and by people with reduced physical, sensory or mental skills or a lack of experience or knowledge, provided that they are supervised or have been instructed on how to use the device safely, and are fully aware of the consequent risks of use.
- Children must not play with the device.
- Cleaning and user maintenance must not be performed by children unless supervised.
- Disconnect the device from the mains supply during cleaning.
- Clean the device using only the methods specified. Under no circumstances must liquid enter the fan unit.
- Do not use any solvent-based cleaning products.
- If the mains connection cable of this device is damaged, it must be disposed of. If it cannot be removed, the device must be disposed of.

Dear customer,

Thank you for choosing one of our products. Our name stands for high-quality, thoroughly tested products for applications in the areas of heat, gentle therapy, blood pressure/diagnosis, weight, massage, beauty, air and baby care.

With kind regards,
Your Beurer team

Getting to know your device

Humans spend a large proportion of their time indoors. The air indoors is often polluted with dust particles, pollen, animal hair, odours, harmful gases as well as various bacteria and viruses. The LR 210 air cleaner cleans the ambient air using a three-layered filter system and an additional integrated ioniser.

The LR 210 air cleaner

- Filters air with a combi filter (activated carbon filter against harmful gases and unpleasant odours, **HEPA filter H 13** against particles such as bacteria, viruses, mites, pollen and fine dust)
- has a selectable ioniser
- Operates quietly with three output levels
- Has a timer function (two, four or eight hours)
- has a sleep mode
- Is suitable for rooms from 10 m² ¹⁾ - 26 m² ²⁾, in size,
- Energy-saving
- Switches off automatically when the housing cover is removed.

¹⁾ (ANSI/AHAM AC-1 2015)

²⁾ (NRCC 54013-2011)

Principle of air cleaning

1. The air cleaner's fan sucks in the contaminated air.
2. The pre-filter filters out larger particles such as dust, dirt and hairs.
3. Next, the activated carbon filter filters formaldehyde, benzene and other poisonous gases and unpleasant odours out of the ambient air.
4. The HEPA filter then filters out small particles such as pollen, bacteria or viruses.
5. The ioniser releases ions into the air. These negative ions bind the smallest particles to themselves due to the pull of the electric charge. Due to this higher concentration and the formation of larger particles, the particles are then collected in the ioniser collector or land on the floor, where they can be vacuumed up.
6. The cleaned air is emitted via the air outlet on top of the air cleaner into the ambient air.

 The HEPA H 13 filter has a filter performance of $\geq 99.95\%$. That means that 99.95% of particles (e.g. bacteria, viruses and fine dust) can be filtered out.

Contaminated, unfiltered air can have the following effects:

- Infections and respiratory diseases are more likely to occur
- Damage to health through harmful gases

Table of contents







1. Included in delivery	13	7.4 Timer function	17
2. Signs and symbols	13	7.5 Filter change.....	18
3. Warnings and safety notes	14	8. Cleaning and maintenance	19
4. Intended use	15	8.1 Cleaning the filter	19
5. Device description	15	8.2 Cleaning the housing.....	19
6. Initial use	16	8.3 Storage	19
6.1 Removing the air cleaner.....	16	9. Accessories and replacement parts	19
6.2 Setting up the air cleaner	16	10. What if there are problems?	20
7. Usage	17	11. Disposal	20
7.1 Switching on the air cleaner	17	12. Technical specifications	20
7.2 Fan speed	17	13. Warranty / Service	21
7.3 Ioniser/Sleep mode	17		

1. Included in delivery

- 1x air purifier
- 1x combi filter (activated carbon/HEPA filter class H 13)
- 1x pre-filter
- 1 x set of instructions for use

2. Signs and symbols

The following symbols appear in these instructions for use:

	WARNING Warning instruction indicating a risk of injury or damage to health		Manufacturer
	IMPORTANT Safety note indicating possible damage to the device/accessory		CE labelling This product satisfies the requirements of the applicable European and national directives.
	Product information Note on important information		Dispose of packaging in an environmentally friendly manner

	Read the instructions		Certification symbol for products that are exported to the Russian Federation and members of the CIS
	Disposal in accordance with the Waste Electrical and Electronic Equipment EC Directive – WEEE		"Geprüfte Sicherheit" safety mark

3. Warnings and safety notes

Read the notes carefully! Non-observance of the following information may result in personal injury or material damage.

WARNING

Keep packaging material away from children to avoid danger of suffocation.

Electric shock

WARNING

As with every electrical device, use this air cleaner carefully and cautiously, in order to avoid hazards due to electric shock.

- Therefore, observe the following instructions for use:
 - do not operate the device at voltages other than those indicated on the device (the type plate is located on the back of the device),
 - never if it or its accessories show visible signs of damage
 - not during a thunderstorm
- In the event of defects or operational faults, switch the device off immediately and disconnect it from the mains socket. Do not pull on the mains cable or on the device to disconnect the plug from the socket. Never hold or carry the device by the mains cable. Keep the cables away from hot surfaces.
- Always switch off the device before disconnecting it from the mains.
- Never disconnect the mains plug with wet or damp hands.
- Keep the device away from sources of heat as the housing could melt and trigger a fire.
- Ensure that the openings of the device and the mains cable do not come into contact with water, steam or other liquids.
- Do not use the device in close proximity to flammable or explosive gas mixtures.
- Never reach for a device that has been submerged in water. Disconnect it from the mains plug immediately.
- Do not use the device if it or its accessories are visibly damaged.

Repairs

WARNING

- Only specialist personnel may perform repairs on electrical devices. Improper repairs may subject users to considerable danger. For repairs, please contact Customer Services or an authorised retailer.
- Do not open the fan unit.

Risk of fire

WARNING

There is a risk of fire if the device is used improperly or these instructions for use are ignored. Therefore, observe the following instructions for using the air cleaner:

- Never use underneath a cover, such as a blanket, pillow etc.
- Never use near petrol or other highly flammable substances.

Handling

IMPORTANT

The device must be switched off and disconnected from the mains after every use and before cleaning.

- Do not place any objects in device openings or in rotating parts. Ensure that the moving parts can move freely at all times.
- Do not place any objects on the device.
- Do not expose the device to high temperatures.
- Protect the device against sunlight and impacts and do not drop it.
- Never shake the device.
- Place the device on a firm and level surface.

4. Intended use

This air cleaner is intended exclusively for cleaning the air indoors. The device is intended for private use.

WARNING

If you suffer from severe respiratory or lung disease, consult your doctor before using the air cleaner.





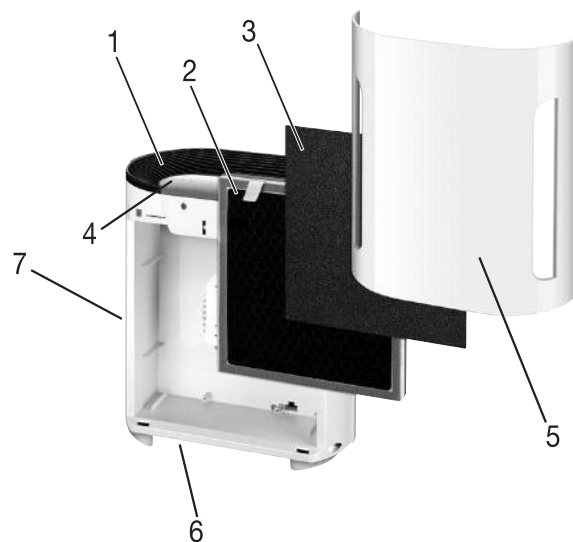



This device must only be used for the purpose for which it was designed and in the manner specified in the instructions for use. Improper use can be dangerous. The manufacturer is not liable for damage resulting from improper or careless use.

5. Device description



1. Air outlet	5. Housing cover
2. Combi filter (activated carbon filter/HEPA filter H 13) <u>Activated carbon filter:</u> To counter harmful gases and unpleasant smells <u>HEPA filter H 13:</u> Filters particles such as bacteria, viruses, mites, pollen and fine dust	6. Housing
3. Pre-filter Filters coarse dust and dirt, such as hairs	7. Air inlet
4. Control panel	

Display and buttons

ON/OFF FILTER RESET	I II III	ION SLEEP	2H 4H 8H
 1	 2	 3	 4
1 ON/OFF button  Switches the device on/off If the light below “Filter reset” is flashing, change the filter. After changing the filter, hold down the on/off button to reset the filter change display.		3 Ioniser/Sleep mode  Switching the ioniser or night mode on/off..	
2 FAN SPEED button  The air cleaner has three fan speeds: I (low), II (medium) and III (high).		4 TIMER button  The air cleaner features a timer function that you can use to determine the number of hours the air cleaner should run for before it automatically switches itself off. The air cleaner has three timer periods: 2H (two hours), 4H (four hours) and 8H (eight hours).	

6. Initial use

6.1 Removing the air cleaner

1. Open the cardboard packaging.
2. Remove the device from the top of the box without opening the film bag.
3. Now remove all plastic films. Remove the combi filter from the device (see “Filter change” section) and take it out of the plastic film. Then re-insert the combi filter into the device.
4. Check the device, mains plug and cable for damage.

6.2 Setting up the air cleaner

1. Place the air cleaner on a firm, level surface to prevent vibrations and noise.



IMPORTANT

If you wish to reposition the air cleaner, only carry it by the handle on the rear of the device.

2. Set up the air cleaner in such a way that there is at least 30 cm clearance on all sides.
3. Make sure that the air inlet and air outlet are never blocked.

7. Usage

7.1 Switching on the air cleaner

1. Always follow the instructions in chapter “Initial use”.
2. Insert the mains plug into the socket. Ensure that the cable does not pose a trip hazard.
3. Press the ON/OFF button () to switch on the air cleaner.

 **Note**
When starting up for the first time, all of the LEDs initially light up. The air cleaner is then set to the lowest fan speed and the ioniser is activated.

 **Note**
If the “Filter reset” light above the on/off button is flashing, you must replace the combi filter. To do this, follow the instructions in the “Filter change” section.

7.2 Fan speed

The air cleaner has three fan speeds: I (low), II (medium) and III (high).

- To switch between the individual fan speeds, press the fan speed button (). The fan speed that is currently set lights up on the control panel.



7.3 Ioniser/Sleep mode

	Ioniser	Sleep mode	Note
1 x press	ON	OFF	„ION“ LED illuminates
2 x press	ON	ON	„ION“ LED illuminates „Sleep“ LED flashes
3 x press	OFF	ON	„ION“ LED goes out „Sleep“ LED flashes
4 x press	OFF	OFF	„Sleep“ LED goes out

If sleep mode is activated, all the LEDs in the operating panel automatically switch off after 10 seconds. To deactivate sleep mode, press any button on the operating panel.

7.4 Timer function

The air cleaner features a timer function that you can use to determine the number of hours the air cleaner should run for before it automatically switches itself off. The air cleaner has three timer periods: 2H (two hours), 4H (four hours) and 8H (eight hours).

- To switch between the individual timer periods, press the TIMER button () The TIMER period that is currently set lights up on the control panel. The air cleaner will now automatically switch off after the set number of hours has passed.
- To switch off the timer, repeatedly press the TIMER button () until the light above the TIMER button goes out. The air cleaner will now clean for an unlimited period.

7.5 Filter change

The three-layered filter should be replaced with a new one after 4320 operating hours. After 4320 operating hours, the red „Filter reset“ LED flashes above the on/off button. To change the filter, proceed as follows:



1. Press the ON/OFF button to switch off the air cleaner, and unplug it from the socket.

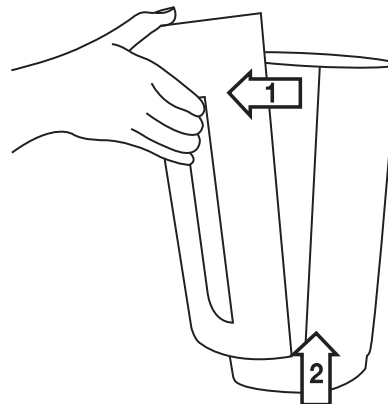

2. Remove the housing cover as shown (magnetic fastening). First detach the magnetic fastening at the top, and then at the bottom.

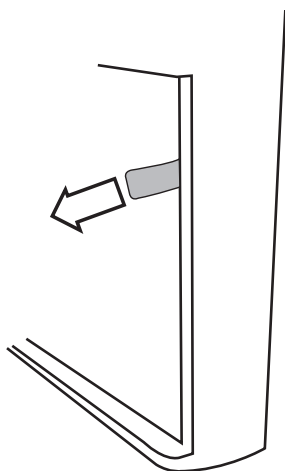

3. Pull out the pre-filter. Now, to pull out the combi filter, pull carefully on the side tabs.

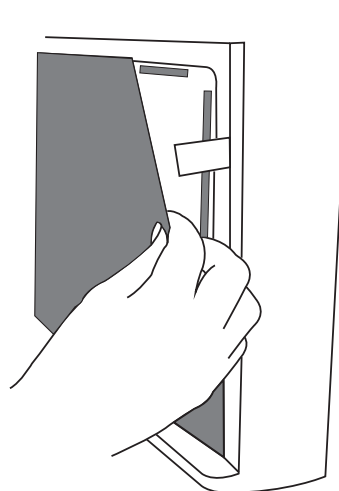

4. Insert a new combi filter. To insert the combi filter correctly, align it with the tabs as shown. Position the pre-filter above it.

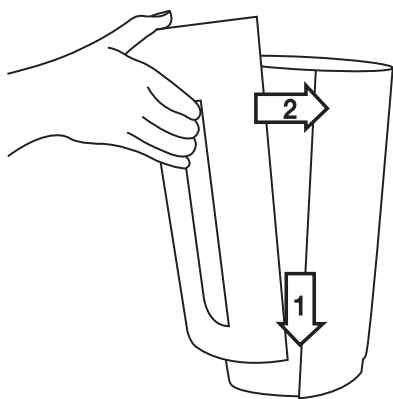

5. Re-insert the housing cover as shown until you see and hear it click into place (magnetic fastening). First attach the magnetic fastening at the bottom, and then at the top.



6. Insert the mains plug into the socket. Ensure that the cable does not pose a trip hazard. Press and hold the on/off button (⏻) for five seconds. The operating hours counter now resets to 0.

i If you wish to change the combi filter at specific personal intervals (e.g. every six months), there is a sticker on the upper edge of the combi filter on which you can enter, for example, the date it was inserted or changed.

8. Cleaning and maintenance



WARNING

Before cleaning, always ensure that the mains plug of the air cleaner has been properly disconnected.

8.1 Cleaning the filter

Regular cleaning of the filter (once a month) is a prerequisite for hygienic and fault-free operation.

- Clean the three-layered filter using the brush attachment of a vacuum cleaner. To carry out a thorough clean, pull out the pre-filter and clean the activated carbon filter located behind it and the HEPA filter located at the rear, also using the brush attachment from a vacuum cleaner. Then replace the pre-filter on the HEPA filter.

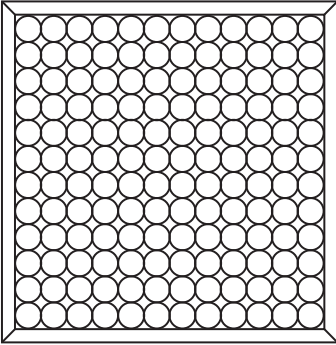
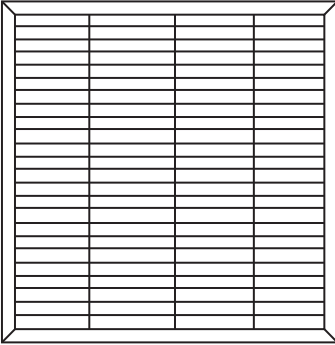
Activated carbon filter	HEPA filter H 13
	
Front	Rear



IMPORTANT

The three-layered filter should be changed after 4320 operating hours (see “Filter change” section).
The three-layered filter cannot be washed.

8.2 Cleaning the housing

Clean the housing of the air cleaner with a damp cloth (water or a mild cleaning solution). When cleaning, do not use any solvents or other aggressive or abrasive cleaning agents, as the surface may become damaged.

8.3 Storage

If you do not plan to use the device for a long period of time, we recommend that you clean it and store it in the original packaging in a dry environment, ensuring it is not weighed down by additional items.

9. Accessories and replacement parts

Replacement parts and wearing parts are available from the corresponding service address (according to the service address list). Please state the corresponding order number.

Designation	Item number and/or order number
Pre-filter, combi filter (HEPA + activated carbon)	693.01

10. What if there are problems?

Problem	Cause	Solution
The air cleaner will not switch on	The housing cover is not correctly installed.	Ensure that the housing cover is correctly installed.
	The three-layered filter is not correctly inserted.	Ensure that the three-layered filter is correctly inserted.
	The mains part plug is not plugged in.	Plug the mains part plug into a suitable socket.
Insufficient passage of air	The filters are dirty	Clean the filters (see “Maintenance and storage” section).
	The air intake/air outlet is blocked.	Ensure that the air intake/air outlet is not blocked.
Air cleaner is very loud	There is a foreign body in the air intake/air outlet.	Remove the foreign body from the air intake/air outlet.
	The filters are clogged.	Clean the filters (see “Maintenance and storage” section).
	The filters are not correctly inserted.	Insert the filters correctly.
	The air cleaner is positioned on an uneven surface.	Position the air cleaner on a level surface.

11. Disposal

For environmental reasons, do not dispose of the device in the household waste at the end of its useful life. Dispose of the device at a suitable local collection or recycling point. Dispose of the device in accordance with EC Directive – WEEE (Waste Electrical and Electronic Equipment).

If you have any questions, please contact the local authorities responsible for waste disposal.



12. Technical specifications

Model	LR 210
Mains voltage	See type plate on the device
Output	60 W
Dimensions (L x W x H)	275 x 175 x 308 mm
Weight	2.9 kg
Suitable for rooms	10 m ² (ANSI/AHAM AC-1 2015) - 26 m ² (NRCC 54013-2011)
Volume	approx. 50 dB (Level 3)
Permissible operating conditions	+5°C to +40°C, ≤ 90% relative humidity (non-condensing)
Protection class	Protection class II /
Air flow rate	110 m ³ /h

13. Warranty / Service

Beurer GmbH, Söflinger Straße 218, 89077 Ulm, Germany (hereinafter referred to as “Beurer”) provides a warranty for this product, subject to the requirements below and to the extent described as follows.

The warranty conditions below shall not affect the seller’s statutory warranty obligations which ensue from the sales agreement with the buyer.

The warranty shall apply without prejudice to any mandatory statutory provisions on liability.

Beurer guarantees the perfect functionality and completeness of this product.

The worldwide warranty period is 3 years, commencing from the purchase of the new, unused product from the seller.

The warranty only applies to products purchased by the buyer as a consumer and used exclusively for personal purposes in the context of domestic use.

German law shall apply.

During the warranty period, should this product prove to be incomplete or defective in functionality in accordance with the following provisions, Beurer shall carry out a repair or a replacement delivery free of charge, in accordance with these warranty conditions.

If the buyer wishes to make a warranty claim, they should approach their local retailer in the first instance: see the attached “International Service” list of service addresses.

The buyer will then receive further information about the processing of the warranty claim, e.g. where they can send the product and what documentation is required.

A warranty claim shall only be considered if the buyer can provide Beurer, or an authorised Beurer partner, with

- a copy of the invoice/purchase receipt, and
- the original product.

The following are explicitly excluded from this warranty:

- deterioration due to normal use or consumption of the product;
- accessories supplied with this product which are worn out or used up through proper use (e.g. batteries, rechargeable batteries, cuffs, seals, electrodes, light sources, attachments and nebuliser accessories);
- products that are used, cleaned, stored or maintained improperly and/or contrary to the provisions of the instructions for use, as well as products that have been opened, repaired or modified by the buyer or by a service centre not authorised by Beurer;
- damage that arises during transport between manufacturer and customer, or between service centre and customer;
- products purchased as seconds or as used goods;
- consequential damage arising from a fault in this product (however, in this case, claims may exist arising from product liability or other compulsory statutory liability provisions).

Repairs or an exchange in full do not extend the warranty period under any circumstances.