

# NICO

## TODDLER BED

### INSTRUCTION

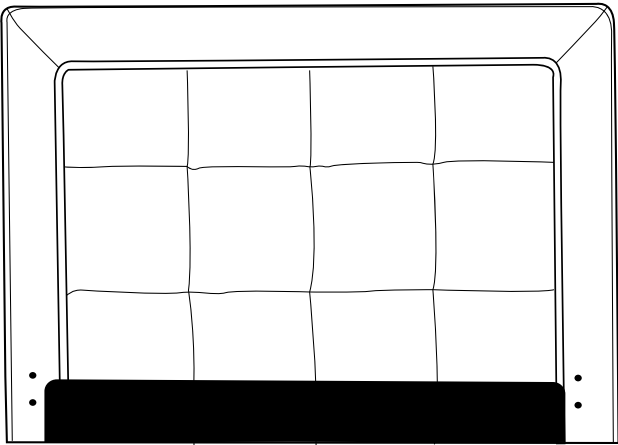

A. QTY1

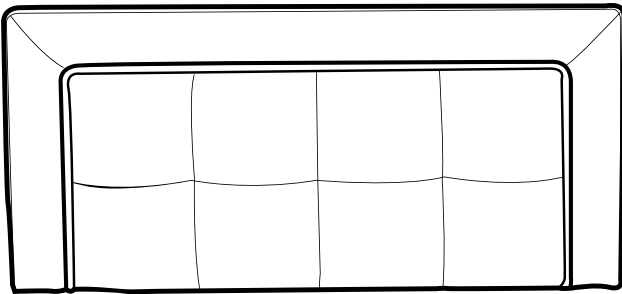

B. QTY1

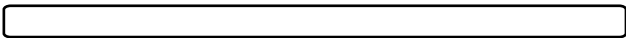

D. QTY3



E. QTY4

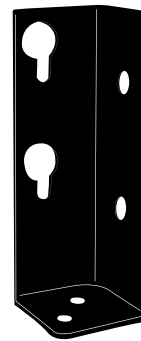

F. QTY4

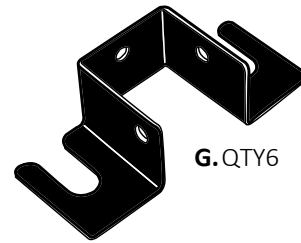

G. QTY6

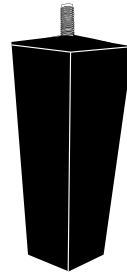

I. QTY4

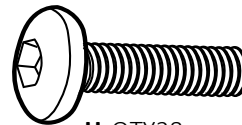

H. QTY28

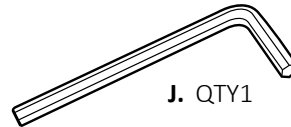

J. QTY1

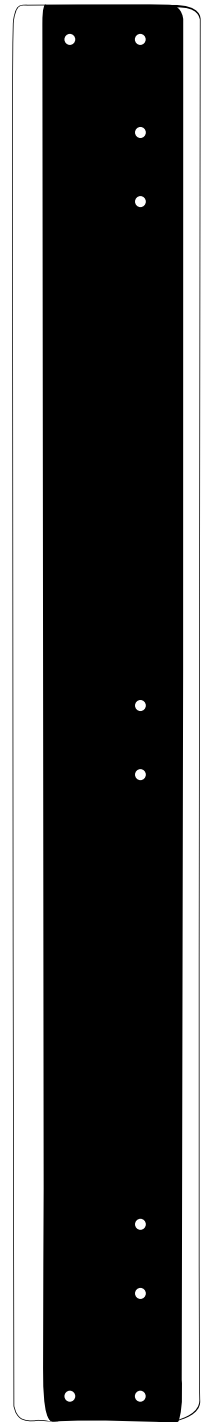

C. QTY2

### BOX CONTENTS



SECOND  
STORY  
HOME

- |                         |                       |
|-------------------------|-----------------------|
| A. HEADBORD x1          | G. SUPPORT BRACKET x6 |
| B. FOOTBOARD x1         | H. ALLE BOLTS x28     |
| C. SIDE PANEL x2        | I. LEGS x4            |
| D. WOODEN STABILIZER x3 | J. ALLEN WRENCH x1    |
| E. BOTTOM PANEL x2      |                       |
| F. SIDE BRACKET x4      |                       |
| G. SUPPORT BRACKET x6   |                       |

# NICO

## TODDLER BED

### INSTRUCTION

#### WHAT YOU WILL NEED

- C. SIDE PANEL x2
- F. SIDE BRACKET x4
- G. SUPPORT BRACKET x6
- H. ALLEN BOLTS x20
- J. ALLEN WRENCH x1

#### STEP: 01

##### SEE FIGURE 1

SET SIDE BRACKET ( F ) ON THE SIDE PANEL ( C ) AS SHOWN BELOW IN EXAMPLE 1. PLACE BRACKET SO THE TWO HOLES ARE AGAINST THE FABRIC. NEXT, PLACE THE LARGER BOLT ( H ) INTO THE TWO HOLES AND TIGHTEN USING ALLEN WRENCH ( J ) AS SHOWN IN EXAMPLE 2. **DO NOT OVERTIGHTEN.** REPEAT UNTIL ALL FOUR BRACKETS HAVE BEEN ATTACHED ON BOTH THE SIDE PANEL ( C ).

#### STEP: 02

##### SEE FIGURE 2

USE THE LARGER BOLTS ( H ) AND LOOSELY SCREW THEM INTO THE FOUR HOLES IN THE MIDDLE OF THE SIDE PANEL. THE SUPPORT BRACKET ( G ) WILL BE PLACED BEHIND THE WASHER. ONCE IS IS SECURED, TIGHTEN THE SCREWS. **DO NOT OVERTIGHTEN.**

FIGURE 1

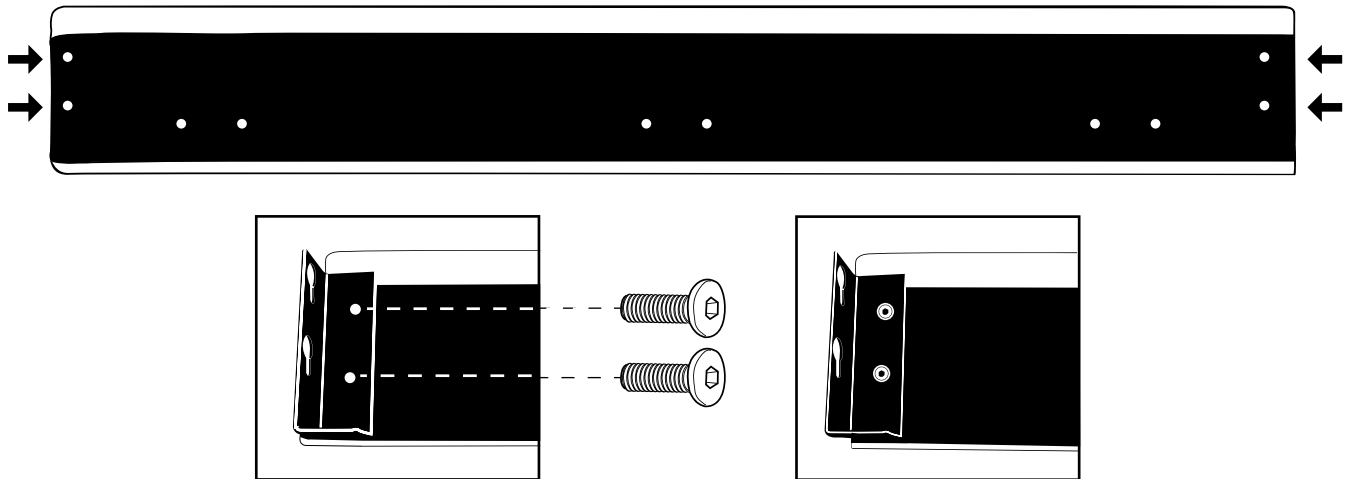
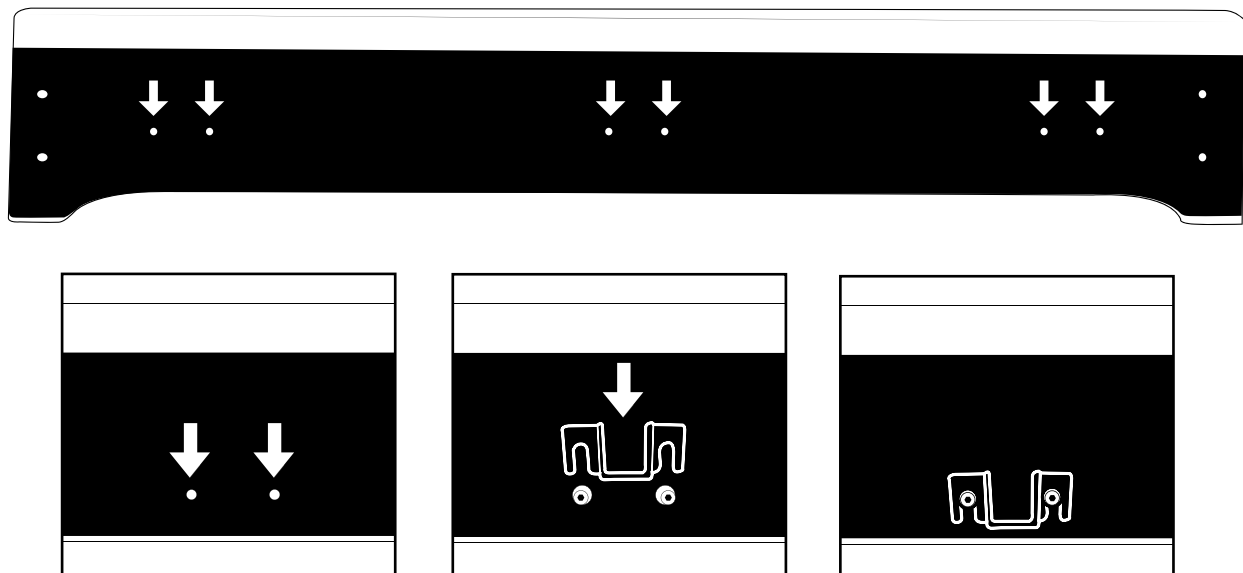

FIGURE 2



# NICO

## TODDLER BED

### INSTRUCTION

#### WHAT YOU WILL NEED

- A. HEADBOARD
  - B. FOOTBOARD
  - D. WOODEN STABILIZER x3
  - H. ALLEN BOLT x8
  - J. LEGS x4
  - I. ALLEN WRENCH
- SIDE PANEL W/ BRACKETS INSTALLED

#### STEP 03

WITH BOTH THE HEADBOARD ( A ) AND FOOTBOARD ( B ) USE THE REMAINING 8 LARGER BOLT ( H ) TO SCREW INTO FOUR BOTTOM HOLES ON EACH OF THE PIECES. LEAVE THESE BOLTS **LOOSE**.

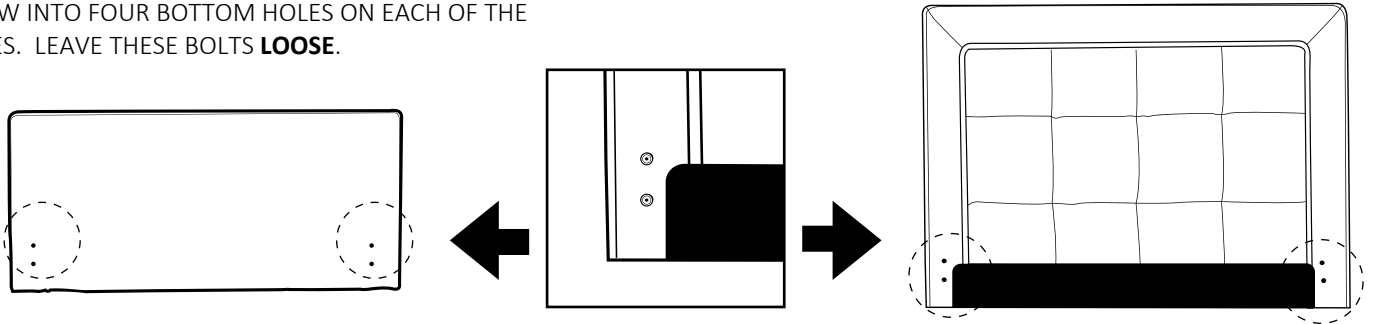

#### STEP 04

TAKE THE HEADBOARD ( A ) AND ALIGN THE BOLTS TO THE SIDE BRACKET ( E ) THAT IS ALREADY ATTACHED TO ONE OF THE SIDE PANELS. ONCE PLACED INSIDE THE HOLE, PRESS DOWN TO LOCK THE BOLT IN PLACE. DO SO UNTIL BOTH THE HEADBOARD ( A ) AND FOOTBOARD ( B ) ARE ATTACHED TO THE SIDE PANELS ( C ). ONCE ALL PIECES ARE ATTACHED, BEGIN TO TIGHTEN EACH OF THE BOLTS USING THE ALLEN WRENCH ( L ).

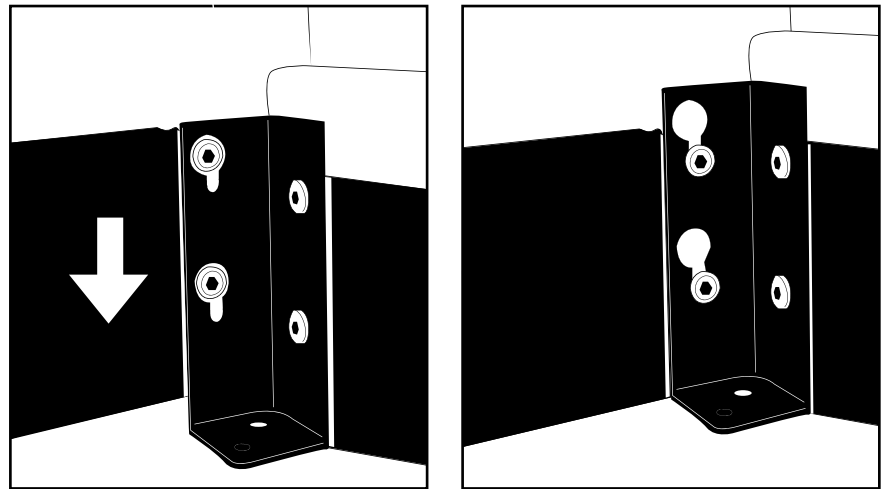

#### STEP 05

FLIP OVER THE TODDLER BED WHEN YOU'VE FINISHED ASSEMBLING THE THE FOUR PIECES OF THE BED TOGETHER. ONCE IT IS FLIPPED ON IT'S SIDE, BEGIN TWISTING THE LEGS ( J ) INTO THE SIDE BRACKETS ( I ) INTO THE SIDE BRACKETS.

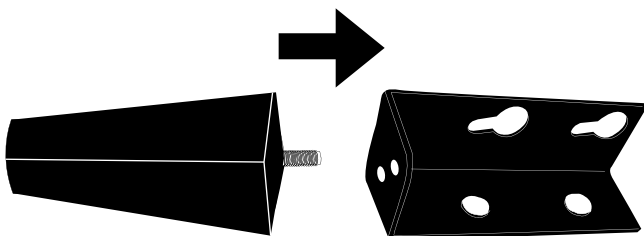

#### STEP 06

WHEN FINISHED WITH ALL FOUR LEGS, FLIP OVER SO THAT THE BED IS NOW STANDING ON IT'S LEGS. PLACE BOTH WOODEN STABILIZER ( D ) INSIDE THE STABILIZER BRACKET TO SECURE THEM IN PLACE.

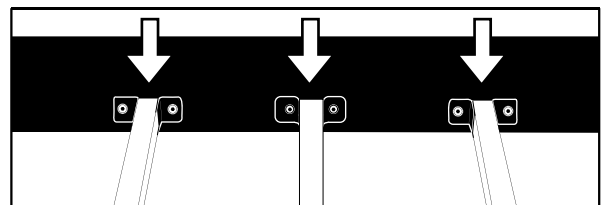

# NICO

## TODDLER BED

### INSTRUCTION

#### WHAT YOU WILL NEED

- I. BOTTOM PANEL x2

#### STEP 07

THE LAST STEP TO BUILDING THE GATSBY TWIN BED IS TO LAY THE BOTTOM PANELS DOWN, SIDE BY SIDE, ONTO THE WOODEN SUPPORTS. **CHECK ALL BOLTS TO BE SURE THAT THEY ARE SECURED BEFORE PLACING MATTRESS DOWN.**

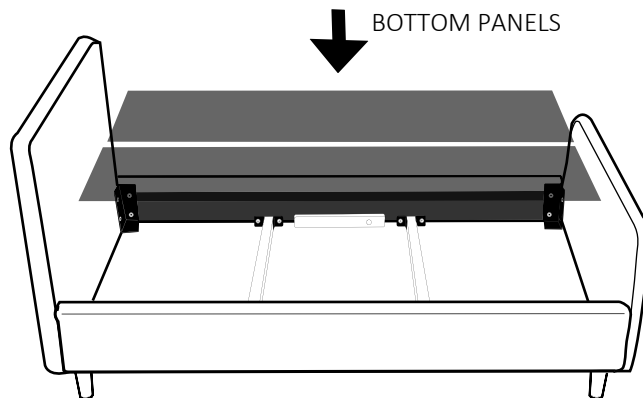

#### CARE AND MAINTENANCE

PERIODICALLY CHECK YOUR BED FOR ANY LOOSE BOLTS AND SCREWS AND TIGHTEN WHERE NEEDED. IF BED IS DAMAGED, DO NOT USE. CONTACT US FOR REPLACEMENT PARTS. SPOT CLEAN ONLY. AVOID EXCESS MOISTURE.

#### ONE YEAR LIMITED WARRANTY

DEFECTIVE PARTS WILL BE REPLACED WITH A ONE YEAR PERIOD FROM DATE OF ORIGINAL PURCHASE. MISSING PARTS WILL BE REPLACED WITHIN 30 DAYS FROM THE DAY OF ORIGINAL PURCHASE. SECOND STORY HOME WARRANTS ONLY NEW UNITS PURCHASED IN IT'S ORIGINAL PACKAGING. THE WARRANTY DOES NOT COVER USED, SECOND HAND OR DEMOS AND IS NON-TRANSFERABLE.

ANY DAMAGED OR DEFECTIVE PART THAT RESULTS FROM NORMAL WEAR AND TEAR, ABUSE, NEGLIGENCE, IMPROPER USE OR ALTERATION TO THE FINISH, DESIGN AND HARDWARE OF THE BED, OR THE ASSEMBLY OF THIS PRODUCT ARE NOT COVERED. THE SPECIFIC LEGAL RIGHTS OF THIS WARRANTY MAY VARY FROM STATE TO STATE. SOME STATES DO NOT ALLOW ANY EXCLUSION OR LIMITATION OF INCIDENTAL OR CONSEQUENTIAL DAMAGES. SOME STATES DO NOT ALLOW LIMITATIONS ON HOW LONG AN IMPLIED WARRANTY LASTS.

#### CONTACT US

PLEASE VISIT OUR WEBSITE AT [WWW.SECONDSTORYHOME.COM](http://WWW.SECONDSTORYHOME.COM) THERE, YOU CAN FIND MORE PRODUCT INFORMATION, REGISTER YOUR PRODUCT, CONTACT US OR REQUEST REPLACEMENT PARTS.

YOU CAN EMAIL OR WRITE  
[SUPPORT@SECONDSTORYHOME.COM](mailto:SUPPORT@SECONDSTORYHOME.COM)

SECOND STORY HOME  
1477 DAVRIL CIR  
CORONA, CA 92878

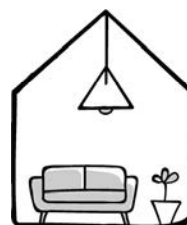

SECOND  
STORY  
HOME