

ABLE

TODDLER BED

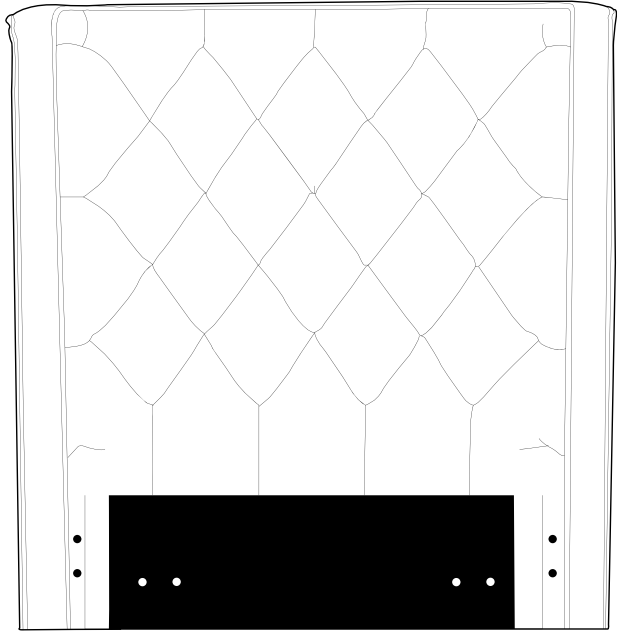

A. QTY1



B. QTY1



I. QTY2

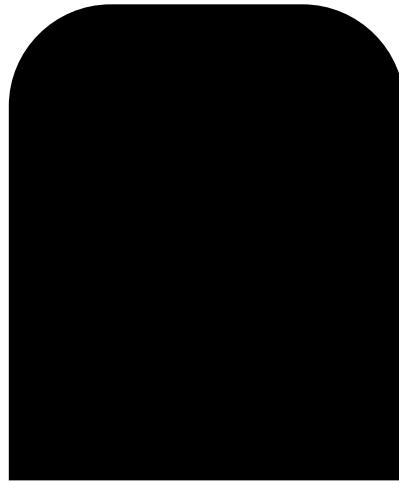

D. QTY1

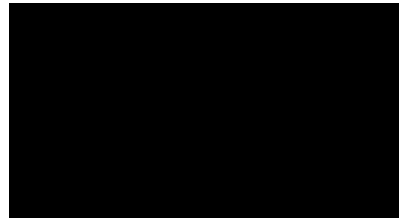

E. QTY1



G. QTY4

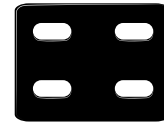

F. QTY2

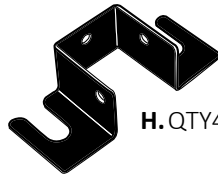

H. QTY4

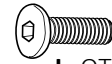

J. QTY32

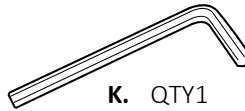

K. QTY1

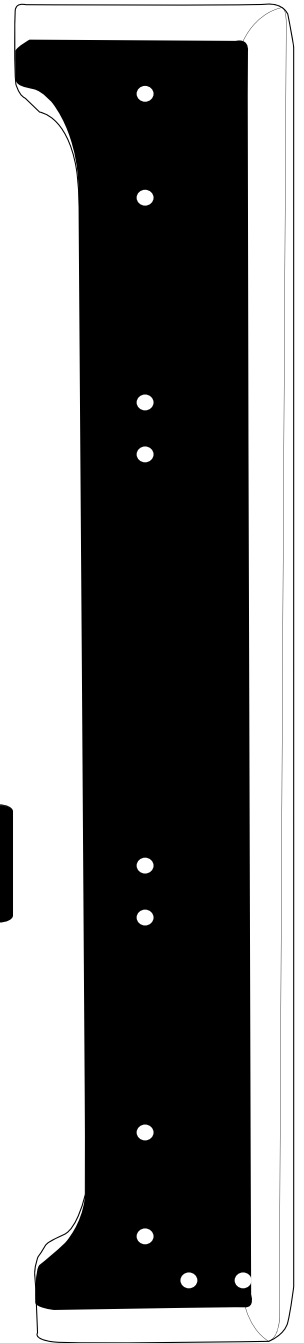

C. QTY2

BOX CONTENTS



SECOND
STORY
HOME

- | | |
|-------------------------|-------------------------|
| A. HEADBORD x1 | I. WOODEN STABILIZER x2 |
| B. FOOTBOARD x1 | J. ALLEN BOLT 1" x32 |
| C. SIDE PANEL x2 | K. ALLEN WRENCH x1 |
| D. BOTTOM PANEL L x1 | |
| E. BOTTOM PANEL X x2 | |
| F. HEADBOARD BRACKET x2 | |
| G. SIDE BRACKET x4 | |
| H. SUPPORT BRACKET x4 | |

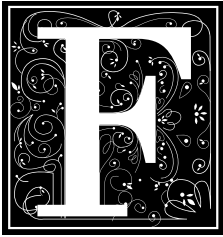

FABLE TODDLER BED

WHAT YOU WILL NEED

- A. HEADBOARD x1
- B. FOOTBOARD x1
- C. SIDE PANEL x2
- F. HEADBOARD BRACKET x2
- G. SIDE BRACKET x4
- H. SUPPORT BRACKET x4
- J. ALLEN BOLT x24
- M. ALLEN WRENCH x1

STEP: 01

INSTALL HEADBOARD BRACKET (F) TO SIDE PANEL (C) USING TWO ALLEN BOLTS (J). REPEAT ON OTHER SIDE.

STEP: 02

INSTALL SUPPORT BRACKETS (H) TO SIDE PANELS (C) USING TWO ALLEN BOLTS (J) FOR EACH BRACKET. REPEAT ON OTHER SIDE.

STEP 1

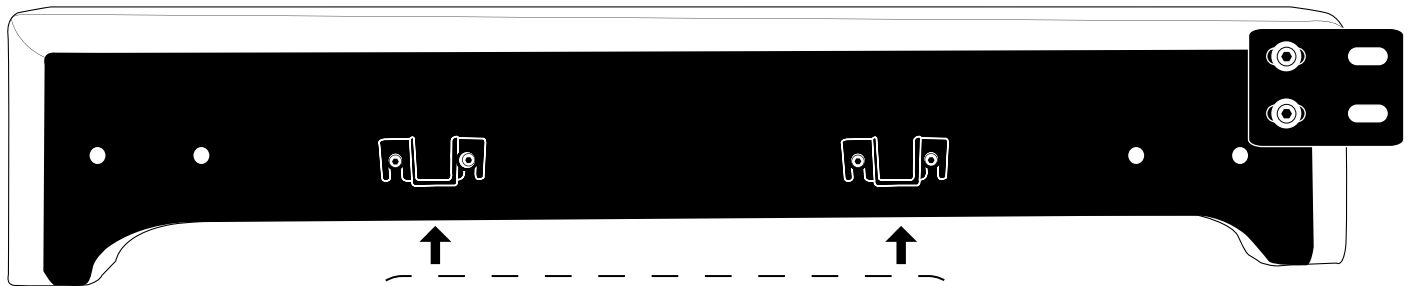
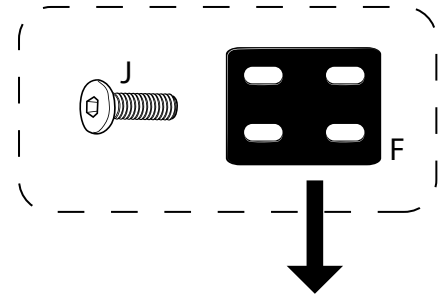

STEP 2



STEP 03

INSTALL SIDE BRACKET (G) TO HEADBOARD (A) AND FOOTBOARD (B) USING ALLEN BOLTS (J).

HEADBOARD

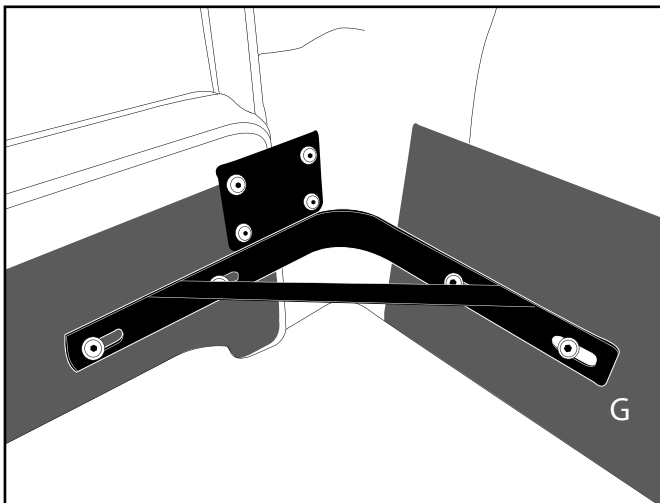

FOOTBOARD

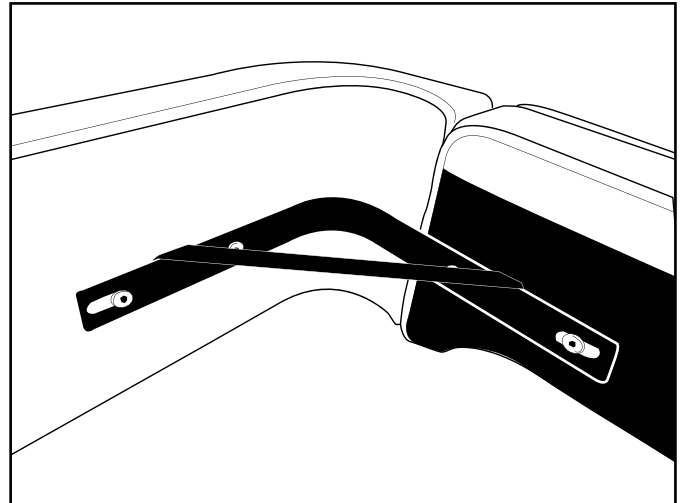

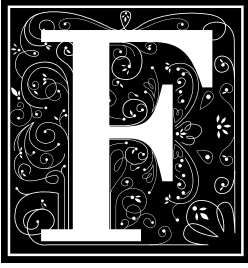

ABLE TODDLER BED

WHAT YOU WILL NEED

- D. BOTTOM PANEL L x1
- E. BOTTOM PANEL X x1
- I. WOODEN STABILIZER x2

STEP 04A

INSTALL THE 3 WOODEN STABILIZERS IN THE SUPPORT BRACKETS.

STEP 04B

PLACE BOTH BOTTOM PANELS DOWN ONTO SUPPORTS.

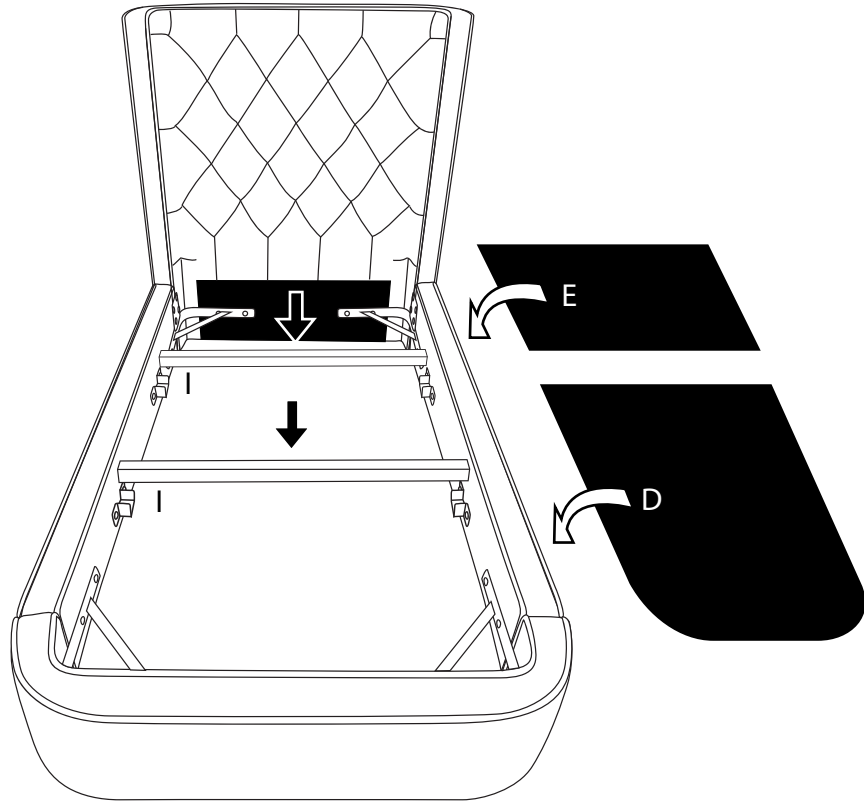

CARE AND MAINTENANCE

PERIODICALLY CHECK YOUR BED FOR ANY LOOSE BOLTS AND SCREWS AND TIGHTEN WHERE NEEDED. IF BED IS DAMAGED, DO NOT USE. CONTACT US FOR REPLACEMENT PARTS. SPOT CLEAN ONLY. AVOID EXCESS MOISTURE.

ONE YEAR LIMITED WARRANTY

DEFECTIVE PARTS WILL BE REPLACED WITH A ONE YEAR PERIOD FROM DATE OF ORIGINAL PURCHASE. MISSING PARTS WILL BE REPLACED WITHIN 30 DAYS FROM THE DAY OF ORIGINAL PURCHASE. SECOND STORY HOME WARRANTS ONLY NEW UNITS PURCHASED IN IT'S ORIGINAL PACKAGING. THE WARRANTY DOES NOT COVER USED, SECOND HAND OR DEMOS AND IS NON-TRANSFERABLE.

ANY DAMAGED OR DEFECTIVE PART THAT RESULTS FROM NORMAL WEAR AND TEAR, ABUSE, NEGLIGENCE, IMPROPER USE OR ALTERNATION TO THE FINISH, DESIGN AND HARDWARE OF THE BED, OR THE ASSEMBLY OF THIS PRODUCT ARE NOT COVERED. THE SPECIFIC LEGAL RIGHTS OF THIS WARRANTY MAY VARY FROM STATE TO STATE. SOME STATES DO NOT ALLOW ANY EXCLUSION OR LIMITATION OF INCIDENTAL OR CONSEQUENTIAL DAMAGES. SOME STATES DO NOT ALLOW LIMITATIONS ON HOW LONG AN IMPLIED WARRANTY LASTS.

CONTACT US

PLEASE VISIT OUR WEBSITE AT WWW.SECONDSTORYHOME.COM THERE, YOU CAN FIND MORE PRODUCT INFORMATION, REGISTER YOUR PRODUCT, CONTACT US OR REQUEST REPLACEMENT PARTS.

YOU CAN EMAIL OR WRITE
SUPPORT@SECONDSTORYHOME.COM

SECOND STORY HOME
1477 DAVRIL CIR
CORONA, CA 92878



SECOND
STORY
HOME